

Data sheet

Injection valve

Type TXI 2



The TXI2 is an injection valve for desuperheating in 2-stage refrigeration systems operating on R22/R407C and other similar refrigerants where the hot gas temperature and the intermediate pressure are the controlling variables.

Application

In principle there are two different ways in which to setup 2-stage refrigeration systems as far as temperature signal to the liquid injection valve is concerned.

Application examples

Example 1

2-stage refrigeration system built up with a combined LP/HP compressor.

intermediate pressure as pressure signal to the injection valve.

In this case the discharge gas temperature on the HP side is used as temperature signal and the

In this example a TXI 2 injection valve is used, see fig. 1.

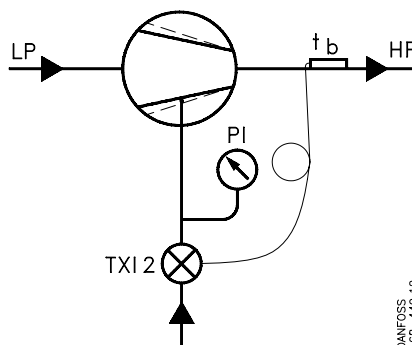

Fig. 1

DANFOSS
A68-448.12

LP: Low pressure
HP: High pressure
PI: intermediate pressure

**Application examples
(continued)**

Example 2

2-stage refrigeration system with 2 separate refrigerating compressors in series. In this set up a solution with injection valve type TXI 2 can be used, because the discharge gas temperature on

the HP side can be used as temperature signal and the intermediate pressure as pressure signal to the injection valve, see fig. 2.

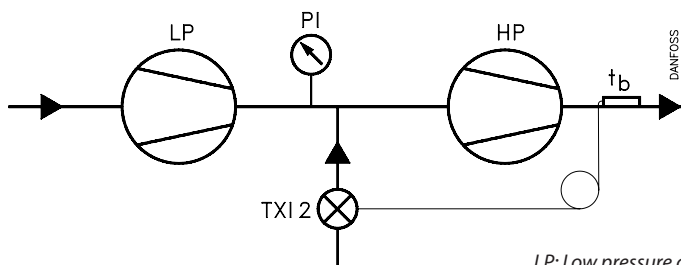

Fig. 2

DANFOSS
A68-448.11

LP: Low pressure compressor
HP: High pressure compressor
PI: Intermediate pressure

Example 3

Same setup as in example 2 with 2 separate refrigerating compressors in series. As in this setup there is an accessible control signal where there is correspondence between pressure and temperature, regulation of the strongly

superheated condition of the refrigerant can be undertaken by a traditional thermostatic expansion valve e.g. Danfoss type TX 2 for R22/R407C refrigeration systems, see fig. 3.

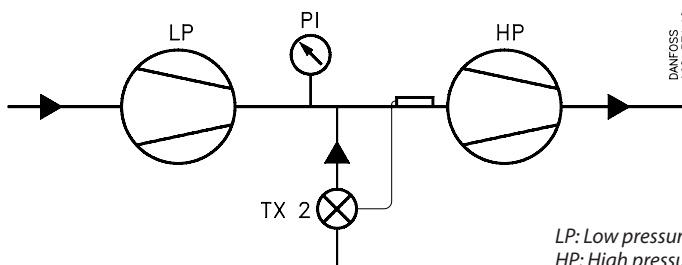

Fig. 3

DANFOSS
A68-571.10

LP: Low pressure compressor
HP: High pressure compressor
PI: Intermediate pressure

Operation

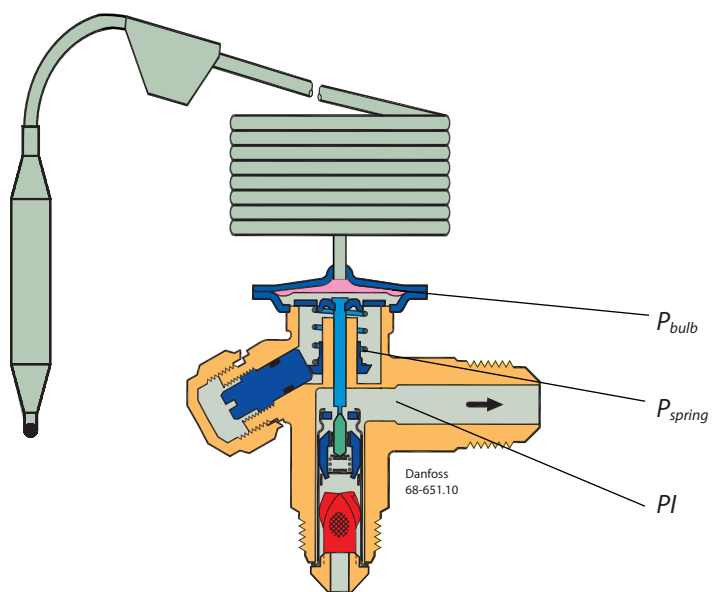
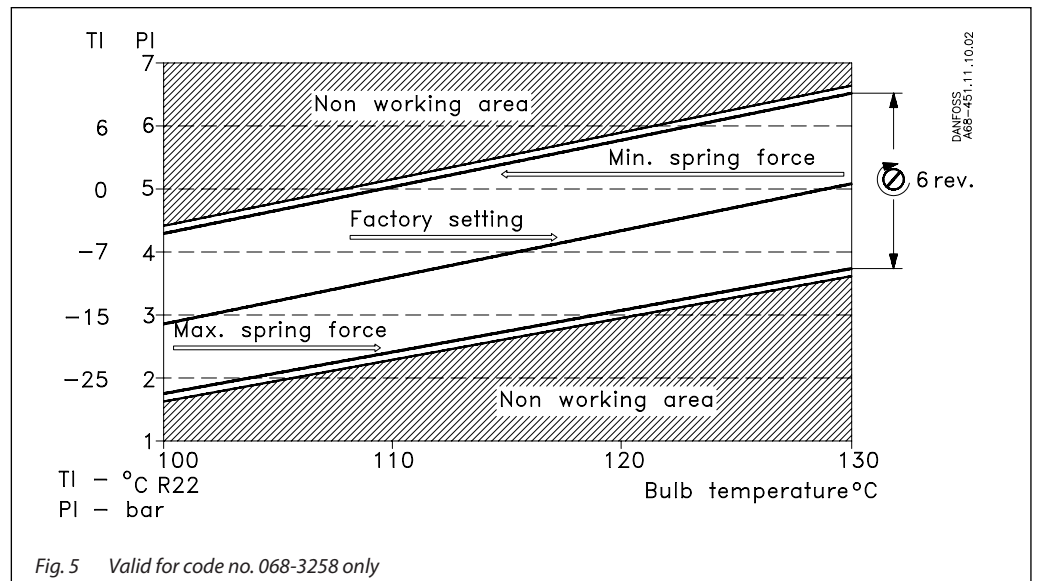
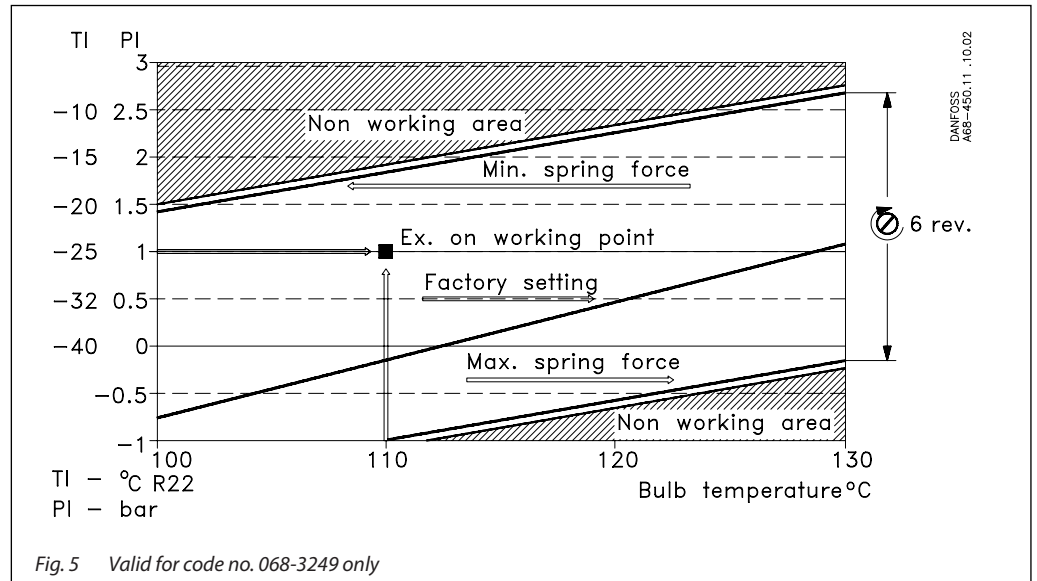

Fig. 4

The valve function is controlled by the intermediate pressure (PI) acting under the diaphragm and the bulb pressure derived from the discharge gas temperature across the diaphragm (fig. 4).

Operation
(continued)

The intermediate pressure (PI), setting spring and bulb temperature form a working range which, expressed in a co-ordinate system, makes up a working area, see fig. 5.



Within the limits of this area, the working point required is found (PI/ t_{bulb}).

The location of the working point depends on the spring force set and in addition to that dependent on the proportional band (the superheat) and the valve capacity (size of orifice).

Therefore, the sizing is decisive for a satisfactory result.

Data sheet | Injection valve type TXI 2

Sizing

To size TXI 2 the refrigerating capacity required to remove the superheat at the intermediate stage must be known as well as the required discharge gas temperature on the discharge side. evaporating temperature t_0 (PI) of the intermediate stage and the pressure drop across TXI 2, the correct orifice size can be determined.

Besides this the pressure drop Δp across the injection valve must be determined as the difference between the condensing pressure and the pressure at the intermediate stage.

With the values for the required capacity, the

Example:

Required refrigerating capacity $Q = 5 \text{ kW}$

Evaporating temperature

at intermediate state $t_0 = -25^\circ\text{C}$

Pressure drop across TXI 2 $\Delta p = 12 \text{ bar}$

Discharge gas temperature (HP) = 110°C

Valve type	Orifice No.	Evaporating temperature -25°C							
		Pressure drop across valve Δp bar							
		2	4	6	8	10	12	14	16
TXI 2 - 0.2	00	0.69	0.83	0.94	1.02	1.08	1.12	1.14	1.15
TXI 2 - 0.3	01	1.21	1.51	1.71	1.85	1.96	2.04	2.09	2.11
TXI 2 - 0.6	02	1.66	2.13	2.42	2.62	2.77	2.87	2.94	2.97
TXI 2 - 0.8	03	2.98	3.82	4.33	4.69	4.96	5.15	5.27	5.33
TXI 2 - 1.2	04	4.36	5.59	6.35	6.89	7.30	7.60	7.80	7.91
TXI 2 - 1.5	05	5.55	7.10	8.06	8.74	9.26	9.64	9.89	10.02
TXI 2 - 2.0	06	6.80	8.68	9.84	10.67	11.30	11.77	12.08	12.25

TXI 2 with orifice 03 fits that example as the values in the capacity tables are shown with a proportional band of 6 K.

Capacity in kW

Valve type	Orifice No.	Evaporating temperature -10°C							
		Pressure drop across valve Δp bar							
		2	4	6	8	10	12	14	16
TXI 2 - 0.2	00	0.79	0.96	1.1	1.2	1.2	1.3	1.3	1.3
TXI 2 - 0.3	01	1.6	2.0	2.3	2.5	2.6	2.7	2.8	2.8
TXI 2 - 0.6	02	2.2	2.9	3.3	3.6	3.8	4.0	4.1	4.1
TXI 2 - 0.8	03	3.9	5.1	5.9	6.4	6.8	7.1	7.3	7.3
TXI 2 - 1.2	04	5.8	7.6	8.7	9.5	10.1	10.5	10.8	10.9
TXI 2 - 1.5	05	7.4	9.6	11.0	12.0	12.8	13.3	13.6	13.8
TXI 2 - 2.0	06	9.1	11.8	13.5	14.7	15.6	16.2	16.6	16.8

Valve type	Orifice No.	Evaporating temperature -20°C							
		Pressure drop across valve Δp bar							
			4	6	8	10	12	14	16
TXI 2 - 0.2	00		0.88	1.0	1.1	1.1	1.2	1.2	1.2
TXI 2 - 0.3	01		1.7	1.9	2.0	2.2	2.3	2.3	2.3
TXI 2 - 0.6	02		2.4	2.7	2.9	3.1	3.2	3.3	3.3
TXI 2 - 0.8	03		4.2	4.8	5.2	5.5	5.8	5.9	6.0
TXI 2 - 1.2	04		6.2	7.1	7.7	8.2	8.5	8.7	8.8
TXI 2 - 1.5	05		7.9	9.0	9.8	10.3	10.8	11.0	11.2
TXI 2 - 2.0	06		9.6	11.0	11.9	12.6	13.1	13.5	13.7

Data sheet | Injection valve type TXI 2
Capacity in kW

Valve type	Orifice No.	Evaporating temperature (PI) –25°C							
		Pressure drop across valve Δp bar							
		2	4	6	8	10	12	14	16
TXI 2 - 0.2	00	0.69	0.83	0.94	1.02	1.08	1.12	1.14	1.15
TXI 2 - 0.3	01	1.21	1.51	1.71	1.85	1.96	2.04	2.09	2.11
TXI 2 - 0.6	02	1.66	2.13	2.42	2.62	2.77	2.87	2.94	2.97
TXI 2 - 0.8	03	2.98	3.82	4.33	4.69	4.96	5.15	5.27	5.33
TXI 2 - 1.2	04	4.36	5.59	6.35	6.89	7.30	7.60	7.80	7.91
TXI 2 - 1.5	05	5.55	7.10	8.06	8.74	9.26	9.64	9.89	10.02
TXI 2 - 2.0	06	6.80	8.68	9.84	10.67	11.30	11.77	12.08	12.25

Valve type	Orifice No.	Evaporating temperature (PI) –30°C							
		Pressure drop across valve Δp bar							
			4	6	8	10	12	14	16
TXI 2 - 0.2	00		0.79	0.90	0.96	1.0	1.1	1.1	1.1
TXI 2 - 0.3	01		1.4	1.5	1.7	1.8	1.8	1.9	1.9
TXI 2 - 0.6	02		1.9	2.2	2.7	2.5	2.6	2.6	2.7
TXI 2 - 0.8	03		3.4	3.9	4.2	4.4	4.6	4.7	4.8
TXI 2 - 1.2	04		5.0	5.7	6.2	6.5	6.8	7.0	7.1
TXI 2 - 1.5	05		6.4	7.2	7.8	8.3	8.6	8.8	9.0
TXI 2 - 2.0	06		7.8	8.8	9.6	10.1	10.5	10.8	11.0

Valve type	Orifice No.	Evaporating temperature (PI) –40°C							
		Pressure drop across valve Δp bar							
		2	4	6	8	10	12	14	16
TXI 2 - 0.2	00	0.60	0.71	0.80	0.86	0.92	0.95	0.98	0.99
TXI 2 - 0.3	01	0.90	1.11	1.25	1.35	1.43	1.49	1.53	1.55
TXI 2 - 0.6	02	1.23	1.55	1.74	1.88	1.97	2.05	2.09	2.12
TXI 2 - 0.8	03	2.20	2.78	3.12	3.36	3.54	3.68	3.77	3.81
TXI 2 - 1.2	04	3.20	4.04	4.56	4.93	5.21	5.43	5.58	5.67
TXI 2 - 1.5	05	4.07	5.14	5.79	6.26	6.62	6.90	7.09	7.20
TXI 2 - 2.0	06	4.98	6.28	7.07	7.65	8.09	8.44	8.68	8.82

Data sheet | Injection valve type TXI 2
Setting

TXI 2 cannot be set until the refrigerant system is started up. Setting after start-up is carried out when the discharge gas temperature has been recorded and the intermediate pressure is known or measured. By means of the diagram, fig. 5, the actual working point is found. From the location of the working point in the diagram, fig.

5, it should be decided whether to increase or decrease the spring force.

Alteration of the spring from slack to tight setting corresponds to 6 revolutions of the TXI 2 setting screw.

Technical data

Perm. working pressure PS/MWP: 34 bar
 Capillary tube: 1.5 m.

Ordering valve

Type	Connections [in.]	Temp. range	Pressure range (pi)	Weight kg	Code no.
TXI-2	$\frac{3}{8} \times \frac{1}{2}$ SAE flare	+100 → +130°C	0 - 2 bar	0.3	068-3249
TXI-2	$\frac{3}{8} \times \frac{1}{2}$ SAE flare	+100 → +130°C	1 - 5 bar	0.3	068-3258
TXI-2	$\frac{3}{8}$ SAE flare × $\frac{1}{2}$ solder	+100 → +130°C	1 - 5 bar	0.3	068-3343
TXI-2	$\frac{3}{8} \times \frac{1}{2}$ SAE flare	+80 → +110°C	1 - 5 bar	0.3	068-3360

Ordering accessories
Orifice assembly

Orifice no.	Code no. TE 2
00	068-2003
01	068-2010
02	068-2015
03	068-2006
04	068-2007
05	068-2008
06	068-2009

Flare nuts

Symbol	Connection for copper tubing with outside diam.		Reducer for copper tubing with outside diam.		Code no.
	in.	mm.	in.	mm.	
	$\frac{1}{4}$	6			011L1201
	$\frac{3}{8}$	10			011L1235
	$\frac{1}{2}$	12			011L1203
	$\frac{3}{8}$	10	$\frac{1}{4}$	6	011L1207

Dimensions and weight

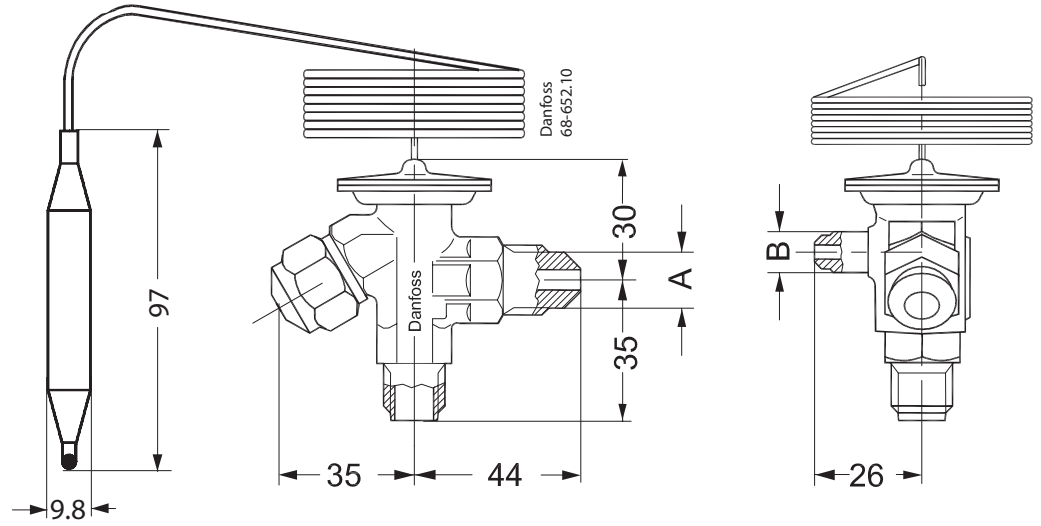

Dimensions in mm

Weight: 0.354 Kg