

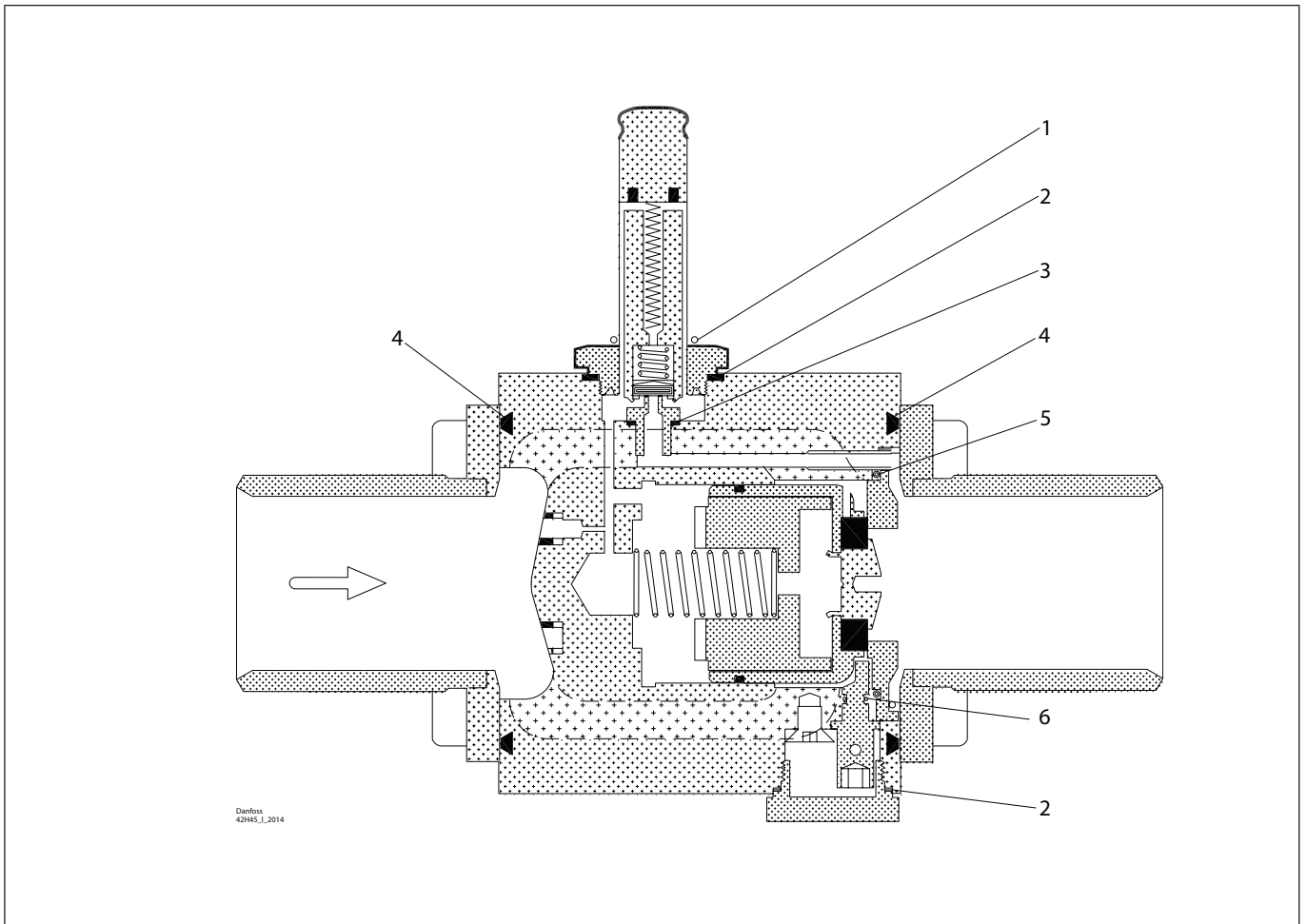

Installation guide – Spare parts and accessories

Inspection kit | Code number 032F2327

AKVA, size 20 and EVRA, size 32/40

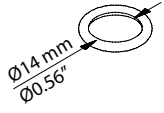
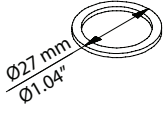
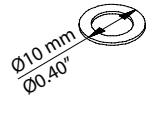

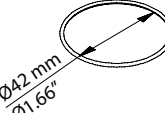
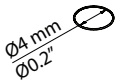
| | | | | |
|---|---|---|---|---|
| <p>1</p>  <p>Ø14 mm Ø0.56"</p> <p>Total no. = 1</p> | <p>2</p> <p>Alu.</p>  <p>Ø27 mm Ø1.04"</p> <p>Total no. = 2</p> | <p>3</p> <p>Alu.</p>  <p>Ø10 mm Ø0.40"</p> <p>Total no. = 1</p> | <p>4</p>  <p>Ø66 mm Ø2.60"</p> <p>Total no. = 2</p> | <p>5</p>  <p>Ø42 mm Ø1.66"</p> <p>Total no. = 1</p> |
| <p>6</p>  <p>Ø4 mm Ø0.2"</p> <p>Total no. = 1</p> | | | | |