

Installation guide – Spare parts and accessories

Inspection kit | Code number 027F3076

PM, PML, PMLX, MRV, size 32 | MEV, PMFH, PMFL, size 125

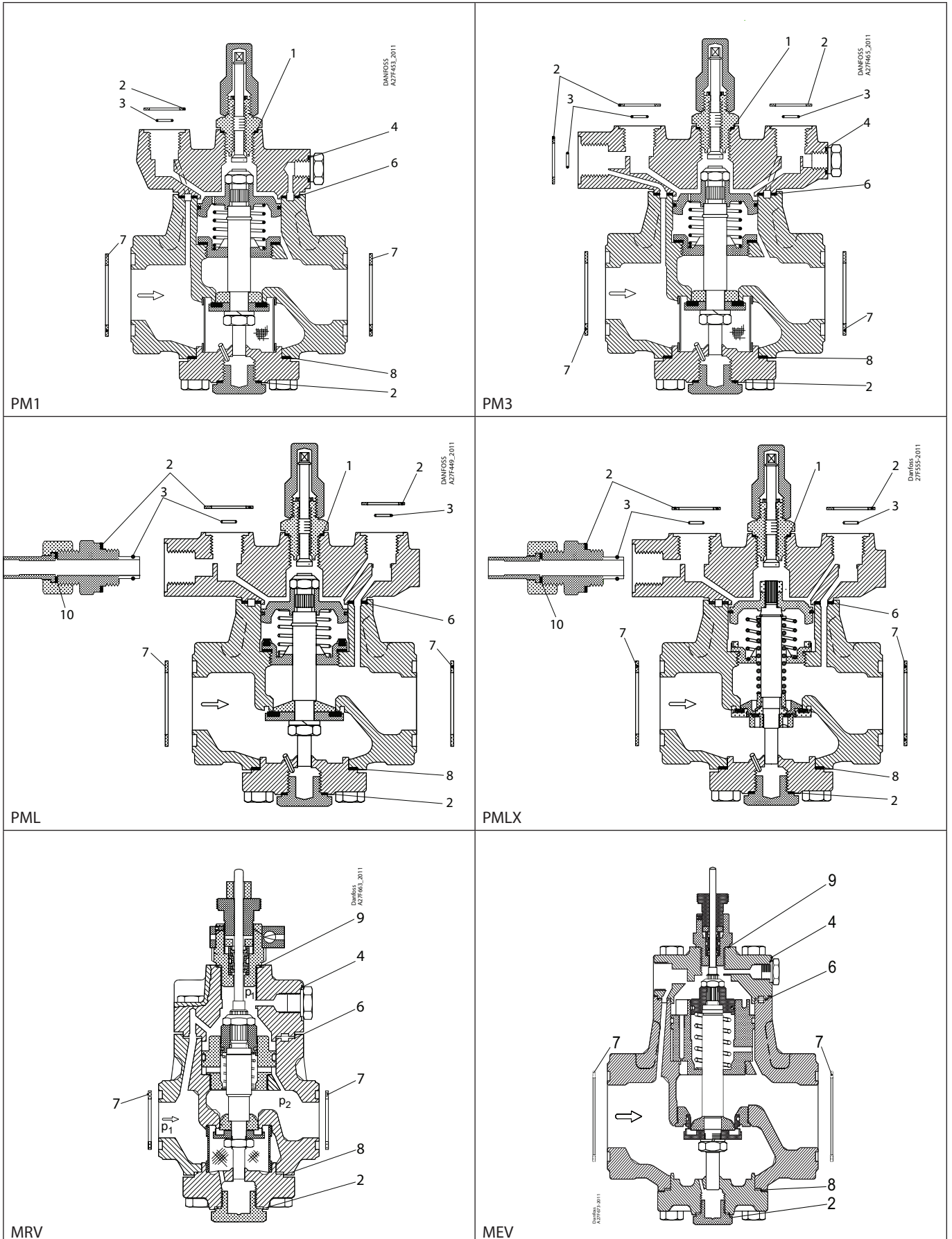

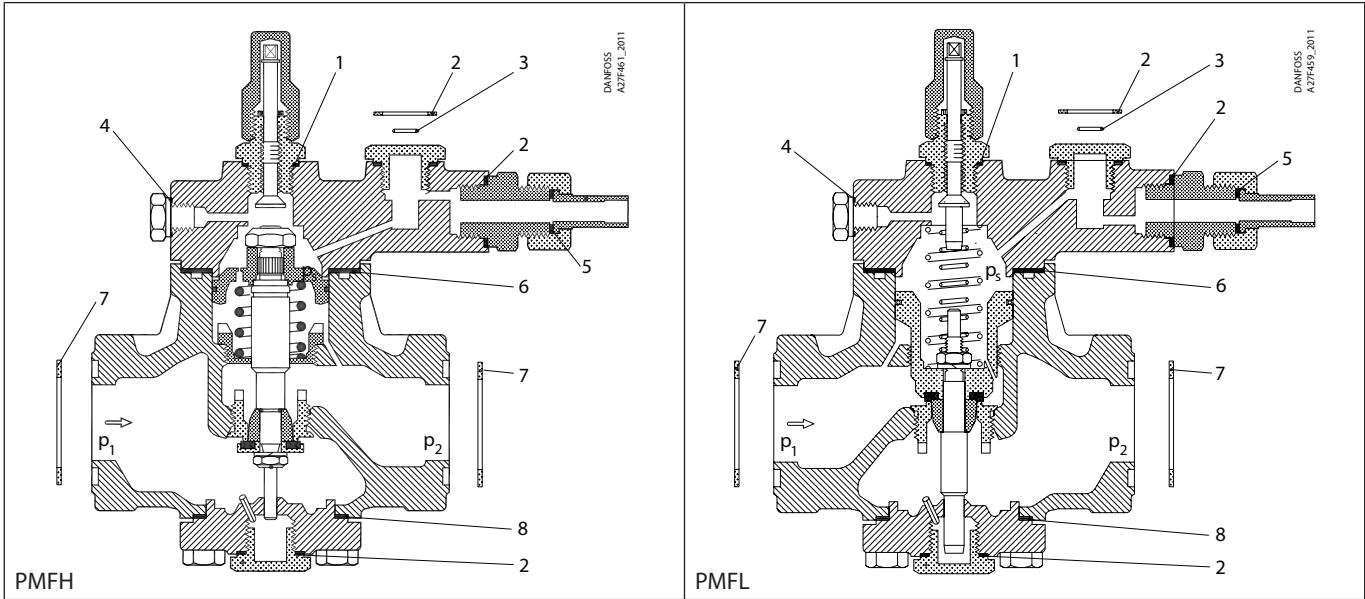

<p>1</p> <p> = Alu.</p> <p>Ø26 mm Ø1.02"</p> <p>Total no. = 1</p>	<p>2</p> <p> = Fibre</p> <p>Ø33 mm Ø1.28"</p> <p>Total no. = 4</p>	<p>3</p> <p> = Alu.</p> <p>Ø9 mm Ø0.36"</p> <p>Total no. = 3</p>	<p>4</p> <p> = Alu.</p> <p>Ø18 mm Ø0.70"</p> <p>Total no. = 1</p>
<p>5</p> <p> = Alu.</p> <p>Ø14 mm Ø0.55"</p> <p>Total no. = 1</p>	<p>6</p> <p> = Fibre</p> <p>Ø85 mm Ø3.35"</p> <p>Total no. = 1</p>	<p>7</p> <p> = Fibre</p> <p>Ø58 mm Ø2.28"</p> <p>Total no. = 2</p>	<p>8</p> <p> = Fibre</p> <p>Ø70 mm Ø2.76"</p> <p>Total no. = 1</p>
<p>9</p> <p> = Alu.</p> <p>Ø32 mm Ø1.26"</p> <p>Total no. = 1</p>	<p>10</p> <p> = Alu.</p> <p>Ø22 mm Ø0.87"</p> <p>Total no. = 1</p>		