

Installation Guide  
**ERC 112**  
Bottle Cooler Controller



DKRCE.PI.RL0.A2.02



520H10340

**Technical specification**

<b>Power Supply</b>	100 – 240 V AC Switch mode power supply. Average 0.7 W	
<b>Input</b>	5 inputs: 4 analogue (digital), 1 digital; user specific assignment • Air / Evaporator / Condenser • Door sensor: all types, user specific • Light sensor: Danfoss ECO light sensor • Motion sensor	
<b>Output</b>	"DO1" (Compressor relay)	UL60730 120 V AC: 16 A resistive / FLA 16/LRA 72 240 V AC: 10 A resistive / FLA 10 / LRA 60 16(16) A
	"DO4"	8 A resistive, FLA 2 / LRA 12, TV-1 8 A resistive, 2(2) A
	"DO5"	FLA 2 / LRA 12, TV-1 8 A resistive, 2(2) A
	"DO6"	FLA 2 / LRA 12, TV-1 8 A resistive, 2(2) A Max 10 A total "DO4-6"
<b>Probes</b>	• Danfoss NTC sensors and Danfoss ECO accessories • Danfoss PT1000 ohm / 0°C	
<b>Connectors</b>	• Modular connector system for OEM customers, with optional output screw terminal adapter • Input connector type: Rast2 5 Edge connectors • output connector type: RAST 5 standard	
<b>Programming</b>	Programming with Danfoss ERC docking station, integrated system	
<b>Assembly</b>	3 types for all controls: front mounting; brackets; fully integrated solution (requires OEM specific design of mounting hole)	

<b>Display</b>	LED display, 3 digit, decimal point and multi functionality icons; °C / °F scale	
<b>Keypad</b>	4 buttons (integrated IP65 design), 2 left, 2 right; user programmable	
<b>Operating Conditions</b>	0 °C – 55 °C, 93% rH	
<b>Storage Conditions</b>	-40 °C – 85 °C, 93% rH	
<b>Range of Measurement</b>	-40 °C – 85 °C	
<b>Protection</b>	Front: IP65 Rear: water and dust protection corresponds to IP31, accessibility of connectors limit rear part rating to IP00	
<b>Environmental</b>	Pollution degree II, non-condensing	
<b>Resistance to heat &amp; fire</b>	Category D (UL94-V0)	
<b>EMC category</b>	Category I	
<b>Operating Cycles</b>	Compressor relay: more than 175.000 at full load (16 A (16 A))	
<b>Approvals</b>	<ul style="list-style-type: none"> <li>• R290 / R600a end-use applications employing in accordance to EN / IEC 60335-2-24, annex CC and EN / IEC 60335-2-89, annex BB</li> <li>• Glow wire according to EN / IEC 60335-1 / IEC / EN 60730</li> <li>• UL60730</li> <li>• NSF</li> <li>• CQC</li> <li>• GOST R 60730</li> </ul>	• These approvals are only valid when using the accessories approved

**Dimensions**

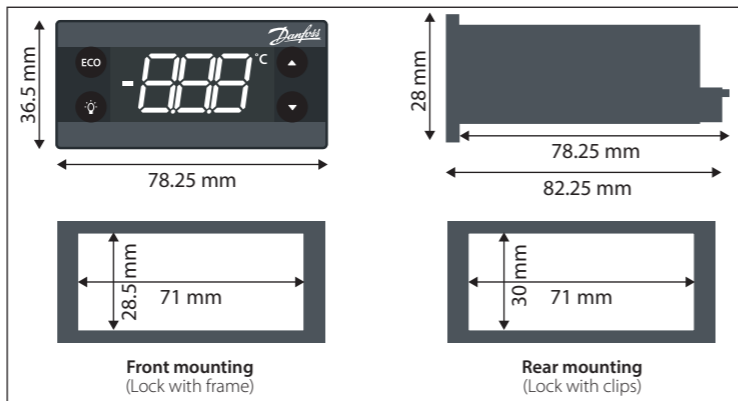

**Functional description of used sensors**

**Control temperature sensor**

The control sensor must always be connected and is used for controlling the cut-in and cut-out of the compressor according to the set-point. The sensor is also used for the displayed temperature. Most common placement is in the return air to the evaporator.

**Evaporator sensor**

The evaporator sensor is only used for de-icing of the evaporator and has no control purpose. Place the sensor where the ice melts last. Please be aware of that sharp fins can damage the cable.

**Condenser temperature sensor**

The condenser sensor is used to protect the compressor against high pressure when the condenser is blocked or the condenser fan fails. Place the sensor at the liquid side of the condenser. Use a metal bracket or metal tape to ensure good thermal conductivity. Be sure that the cable does not pass hot spots at the compressor or condenser that exceeds 80 °C.



**ERC front and button functionality**

Button	Basic function	Not operating	ON/OFF	Increase setpoint	Decrease setpoint	Toggle defrost	Toggle light
1 press	OK						
1 press and hold							
2 press	BACK						
2 press and hold							
3 press	UP						
3 press and hold							
4 press	DOWN						
4 press and hold							

**Configurable functionality**

Button	Toggle ECO	Toggle pulldown	Increase display intensity	Decrease display intensity	Toggle °C or F	Info menu
1 press						
1 press and hold						
2 press						
2 press and hold						
3 press						
3 press and hold						
4 press						
4 press and hold						

**Wiring diagram**

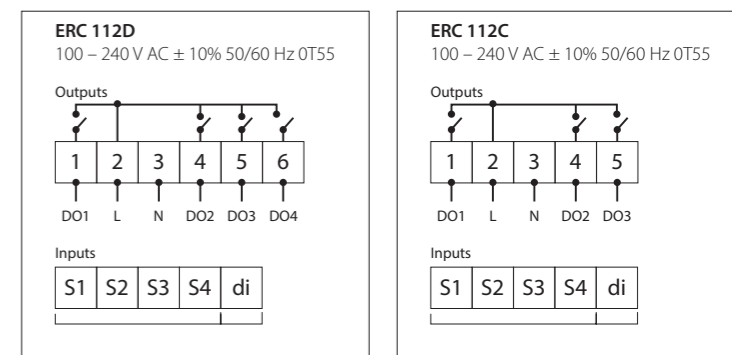

**Configuration of outputs**

Relay outputs	Compress.	Defrost	Fan	Light	Alarm	Heating application
DO1 (o1C)						
DO2 (o2C)						
DO3 (o3C)						
DO4 (o4C)						

**Configuration of inputs**

Input/sensor	Cabinet sensor	Evapor. sensor	Condens. sensor	Door sensor	Light sensor	Movem. sensor	Comm.
S1							
S2							
S3							
S4							
di							

**Menu structure**

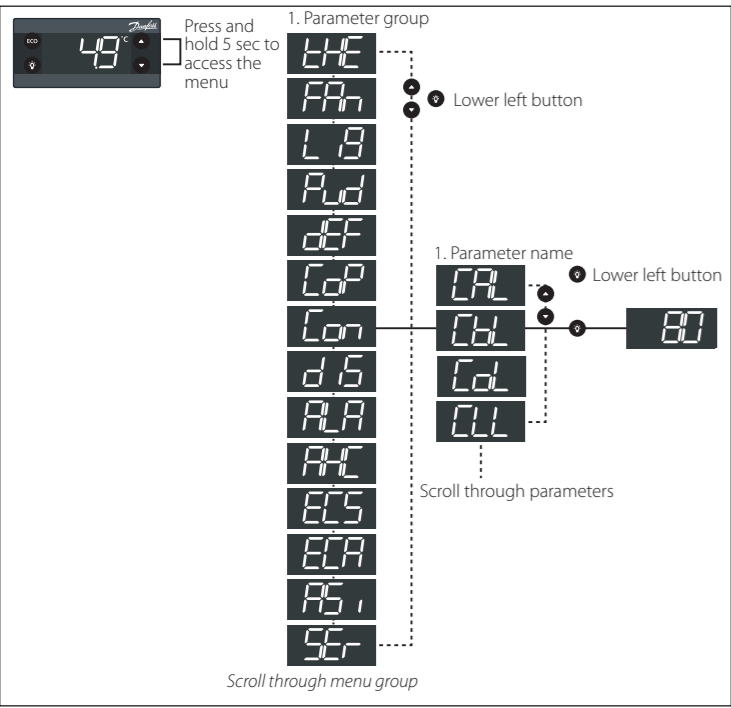

**Operation Changing the setpoint:**

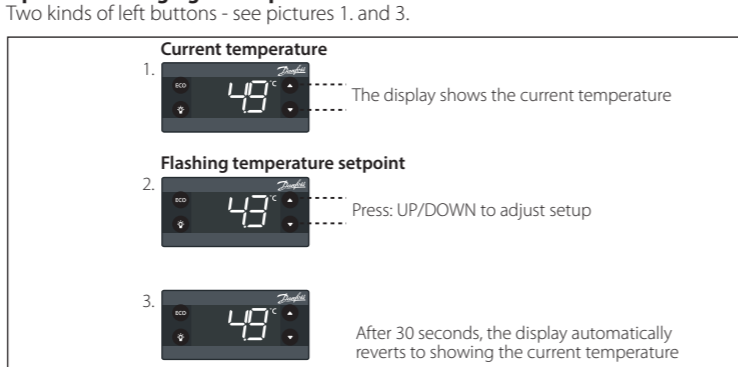

**Activating manual defrost**

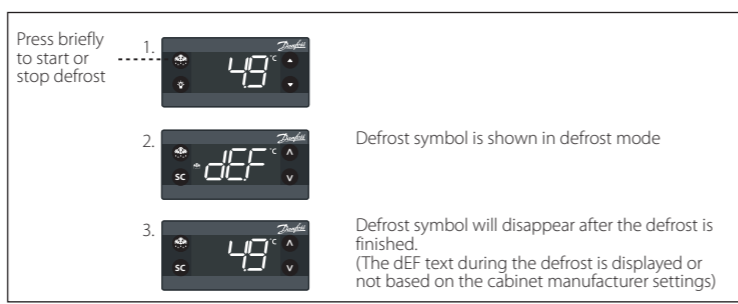

**Example of changing a parameter**

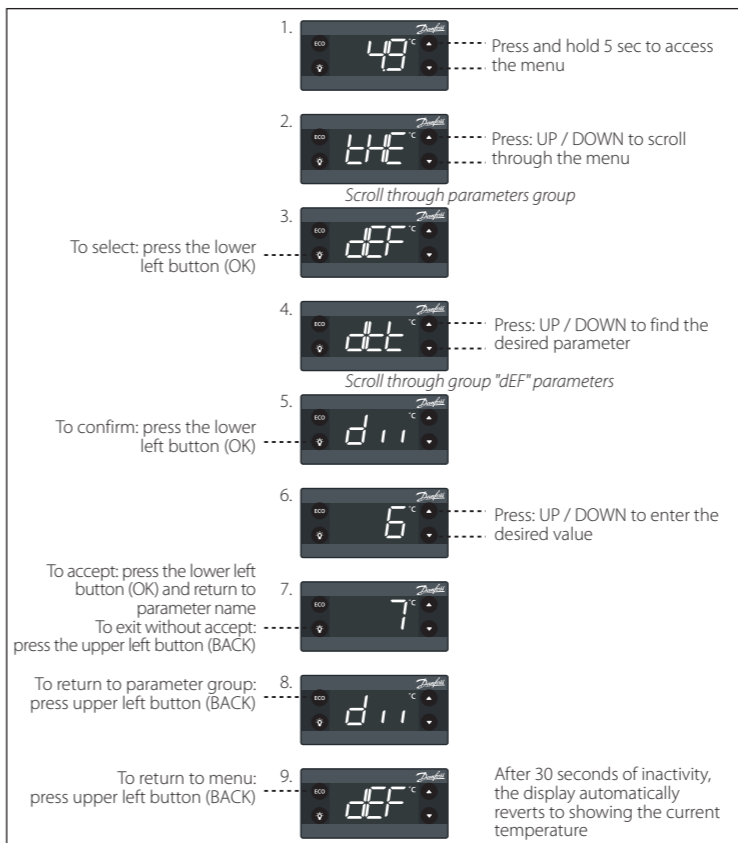

**Turning ON/OFF the ECO function**

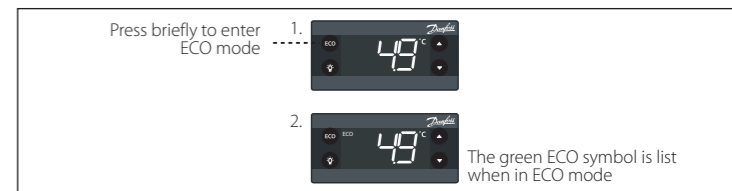

**Password protection**

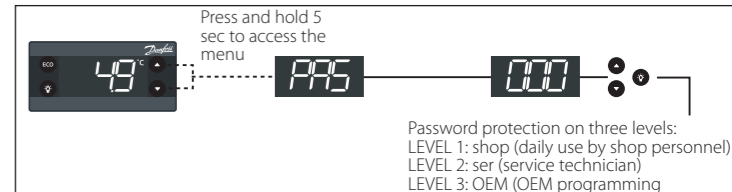

**Acknowledging alarm**

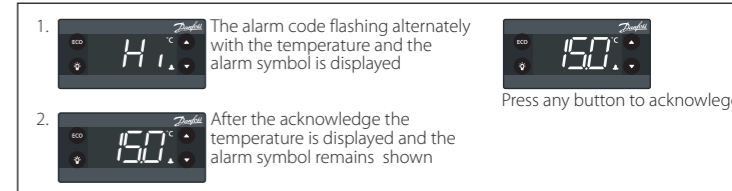

**Parameter table**

Menu	Parameter name	Menu code	Description	Def	Min	Max	Unit	Current setting
<b>Thermostat</b>	<b>tHE</b>	<b>tHE</b>	<b>Main menu for thermostatic settings</b>					
	Set point	SEt	Set point value	2.0	-100.0	200.0	°C	
	Set point adjustment ratio	SPr	Actual value of setpoint adjustment = dIF * SPr	0.5	0.0	1.0		
	Differential	diF	Thermostat differential for serving	2.0	0.0	20.0	K	
	High Set point	HSE	High limitation of thermostat setpoint in position warm	50.0	-100.0	200.0	°C	
	Low Set point	LSE	Low limitation of thermostat setpoint in position cold	-35.0	-100.0	200.0	°C	
	Initial cut in	iCi	Comp relay action when Fair is between Cut-in and Cut-out at power-up yES: Cut in the compressor no: Cut out the compressor	no	no	yES		
<b>Fan</b>	<b>FAN</b>	<b>FAN</b>	<b>Main menu for fan settings</b>					
	Fan control method	FcT	FAo: Fan always on SEt: Fan follow compressor by manually settings Aut: Automatical Fan control	FAo	FAo	Aut		
	Fan On Delay	FoD	Delay for fan start after compressor cutin	0	0	240	Sec	
	Fan Stop delay	FSoD	Delay for fan stop after compressor cutout	0	0	240	Sec	
	Fan On Cycle	FoC	On time for fan during compressor off period	0	0	960	Sec	
	Fan Stop Cycle	FSC	Stop time for fan during compressor off period	0	0	960	Sec	
	Fan Minimum Stop time	FSt	Minimum Stop time for fan protection	10	0	960	Sec	
	Δt for fan to cut in	FdCt	Delta T for fan to cut in which the temperature offset comparing with thermostat cut in temperature	0.0	-10.0	10.0	K	
	Fan delay on door open	Fdt	0: Fan stop immediately when door open 1-998: delay for fan stop after door open 999: fan keep running all the time during door opening	0	0	999	Sec	
<b>Light</b>	<b>Lig</b>	<b>Lig</b>	<b>Main menu for Light settings</b>					
	Cabinet Light Control Source	CLC	on: Always ON (Button is default to control light for all these options) oFF: Always OFF dor: Door sensor only	on	on	dor		
	Light off delay	Lod	Delay to turn off the cabinet light after door close 0: No delay	0	0	300	Sec	
<b>Pull Down</b>	<b>Pud</b>	<b>Pud</b>	<b>Main menu for pull-down settings</b>					
	Pull-down Initiate Temperature	PiC	Temperature measured by control-sensor that will trigger the pull-down mode	50.0	-40.0	50.0	°C	
	Pull-down Cycling	PcY	The duration of the thermostatic operation at pull-down mode The periode will start first time the controller reaches the Pct	30	0	360	min	
	Pull-down defrost Interval	Pdi	Defrost interval during pull-down Over-rules the defrost interval in normal mode	15	0	48	hour	
	Pull-down duration	Pdd	Max time for pull-down mode from initiated till terminated	24	0	48	hour	
	Pull-down limit temp	PLt	The calculated cutout temp for pull-down mustn't lower than this limit to prevent freezing of product	0.0	-55.0	55.0	°C	
	Pull-down reduction temp Δt	Prt	This progressive temp value is used for calculating cutin temp and cutout temp for Pull-down mode: Pulldown-Cutin = NormalCutin - Δt * Hours Pulldown-Cutout = NormalCutout - Δt * Hours	0.1	0.0	10.0	K	
<b>Defrost</b>	<b>dEF</b>	<b>dEF</b>	<b>Main menu for Defrost settings</b>					
	Defrost type	dFt	no: Defrost function is disabled nAt: Natural defrost, time defrost EL: Electrical heater Hgd: Hot gas defrost	no	no	Hgd		
	Adaptive defrost	Add	no: Defrost controlled by time yES: Automatic defrost control activated	no	no	yES		
	Def terminate temp	dtT	Defrost stop temperature	6.0	0.0	25.0	°C	
	Def reset temp	drt	Defrost timer reset temperature 0-199: normal evaluation between evaporator/air temp and drt 200: disable drt function	5.0	0.0	200.0	°C	
	Def Min Interval	dii	Minimum Interval between defrost starts	6	1	96	hour	
	Def Max Interval	dAi	Maximum Interval between defrost starts	7	1	96	hour	
	Def Min Time	dit	Minimum defrost time	5	0	240	min	
	Def Max time	dAt	Maximum defrost time	30	0	480	min	
	Drip off time	dot	Drip off delay time	0	0	60	min	
	Fan delay after Defrost	Fdd	Delay for fan start after defrost	0	0	600	sec	
	Fan start Temp	Ftd	Fan start temperature after defrost, it's based on evaporator temperature. This only applies if an evaporator temperature sensor is fitted	25.0	-25.0	25.0	°C	
	Defrost Fan on	dFA	Fan cutin during defrost	no	no	yES		
	Defrost on compressor time	dCt	no: Elapsed time yES: Accumulated compressor run time	no	no	yES		
	Defrost by compressor running time	doC	Continuous compressor running can cause defrost 0: Deactivated	0	0	24	hour	
	Defrost start evaporator temperature	dEt	Defrost start trigger for adaptive defrost	-50.0	-50.0	0.0	°C	
	Defrost Δt	ddt	Defrost Δt compare with evaporator temperature of first cut out after defrost to trigger defrost start	5.0	0.0	30.0	K	
	Initial Defrost Interval	idi	First time defrost after power-up	3	0	96	hour	
	Initial Defrost Duration	idd	Determine defrost or not while startup by relay1 counter 0: Disable idi function 1-998: Normal evaluation between idd and relay 1 counter 999: idi is always enabled	100	0	999	cycle	
<b>Compressor</b>	<b>CoP</b>	<b>CoP</b>	<b>Main menu for Compressor timer settings</b>					
	Voltage protection	uPt	no: No voltage protection yES: Voltage protection activated based on voltage related settings	no	no	yES		
	Minimum Cutin voltage	uLi	Compressor must not be cut in if power supply goes lower than	0	0	270	Vac	
	Minimum cut-out voltage	uLo	Compressor must be cut out if power supply goes lower than	0	0	270	Vac	
	Maximum voltage	uHi	Maximum supply voltage for the compressor to postpone startup or stop at	270	0	270	Vac	
	Sensor Error Type	EHd	no: No sensor error handling SEt: In case of control sensor error, follow error run/stop time Aut: Automatical Sensor error handling	no	no	Aut		
	Error run time	ErT	Run time for compressor in case of control probe error	0	0	60	min	
	Error stop time	ESt	Stop time for compressor in case of control probe error	1	0	60	min	
	Min Stop time	CSt	Minimum OFF time for compressor	2	0	30	min	
	Min run time	Crt	Minimum ON time for compressor	0	0	30	min	
	Max Off time	Cot	Maximum OFF time for compressor	0	0	480	min	
	Compressor door open delay	Cdd	Door open delay to stop compressor 0: Disable	0	0	15	min	
	System resume after door open	Srt	Fan and Compressor resume after cut out by door open 0: Disable	0	0	60	min	
	Power On Delay	Pod	Delay time from power on until the outputs are activated	300	0	300	Sec	
	Power-on temperature	Pot	If Air temperature at power up is higher than this, power on delay is overruled	-100	-100	200	°C	
<b>Condenser Protection</b>	<b>Con</b>	<b>Con</b>	<b>Blocked condenser protection.</b>					
	Condenser Alarm Limit	CAL	Alarm limit for condenser temperature Available only if condenser sensor is attached / assigned	80	0	200	°C	
	Condenser Block Limit	CbL	Stop limit. If this temperature is exceeded, compressor must be stopped Available only if condenser sensor is attached/assigned	85	0	200	°C	
	Condenser OK limit	CoL	OK limit. Compressor is allowed to start again if the condenser temperature is lower than this temperature Available only if condenser sensor is attached / assigned	60	0	200	°C	
	Condenser Low Temp. Limit	CLL	Low limit. Compressor is not allowed to start if the condenser temperature is lower than this temperature Available only if condenser sensor is attached / assigned	-5	-100	20	°C	
<b>Display</b>	<b>diS</b>	<b>diS</b>	<b>Display settings</b>					
	Display intensity auto control	diC	no: Display intensity use fixed value yES: Display intensity controlled automatically by ambient light	no	no	yES		
	Display Intensity	din	Normal Intensity of display when no ambient light sensor is attached Minimum intensity when ambient light sensor is attached	10	2	10		

Menu	Parameter name	Menu code	Description	Def	Min	Max	Unit	Current setting
	Display Unit	CFu	C: Celsius F: Fahrenheit	-C	-C	-F		
	Temp sensor to display	trS	SCo: Temperature control EuA: Evaporator temperature Con: Condenser temperature (Condenser cleaning) AuS: Only for showing on display	SCo	SCo	AuS		
	Display Resolution	rES	0.1: Decimal with 0.1 degree resolution 0.5: Decimal with 0.5 degree resolution 1: Integers	0.1	0.1	1		
	Display Range Limit	rLt	no: Disabled, display is allowed to go outside of ThSP - diF*SPr ~ ThSP + diF * (1 - SPr) yES: Enabled, display is not allowed to go outside of ThSP - diF*SPr ~ ThSP + diF*(1 - SPr)	no	no	yES		
	Display Delay	ddL	Time-constant for averaging of temperature at display Temp value reaches 100 % when 5 * ddL expires	0	0	10	min	
	Display Offset	doF	Correction for bad sensor placement. Value at 0 °C	0.0	-10.0	10.0	K	
	Lock-time After defrost	dLt	In order not to show a rising temperature during defrosting, the displayed temperature is locked at the temperature shown at the start of the defrost cycle for the number of minutes set in this parameter 0: No lock	15	0	60	min	
	Show Economy/Night Mode	SEC	no: "ECO" and "ngt" will not be showed for Economy / Night Mode yES: "ECO" or "ngt" will be displayed through whole Economy / Night Mode	no	no	yES		
	Show Pull Down	SSC	no: "SC" will not be showed for Pull down state yES: "SC" will be displayed through whole Pull down state	no	no	yES		
	Show Holiday	SHo	no: Display will show temperature or ECO mode during holiday mode yES: Display will show "HoL" during holiday mode	no	no	yES		
	Show Defrost	SdF	no: Display will show temperature during defrost yES: Display will show dEF during defrost	yES	no	yES		
	Show compressor symbol	SCS	no: Compressor symbol will not show on display yES: Show compressor symbol on display	yES	no	yES		
	Show Fan symbol	SFS	no: Fan symbol will not show on display yES: Show fan symbol on display	yES	no	yES		
	Show Defrost symbol	SdS	no: Defrost symbol will not show on display yES: Show defrost symbol on display	yES	no	yES		
	Show ECO symbol	SES	no: ECO symbol will not show on display yES: Show ECO symbol on display	yES	no	yES		
<b>Alarm</b>	<b>ALA</b>	<b>ALA</b>	<b>Main menu for alarm settings</b>					
	High Temp Alarm	HAT	High alarm limit	15.0	-100.0	200.0	°C	
	Low Temp Alarm	LAT	Low alarm limit	-50.0	-100.0	200.0	°C	
	High Alarm delay	Htd	Alarm delay time for high-temperature alarm	30	0	240	min	
	Low Alarm delay	Ltd	Alarm delay time for low-temperature alarm	0	0	240	min	
	Pull-down delay	Pdd	Alarm delay time during & after defrost and after power up (Only for high-temp. alarm)	240	0	960	min	
	Door Open delay	dod	Alarm delay on open door Alarm 0: Disable	2	0	60	min	
	Voltage alarm	uAL	no: No voltage alarm yES: Voltage alarm activated	no	no	yES		
	Leakage alarm	LEA	Leakage detection for compressor protection 0: Disable	0	0	96	hour	
	Alarm Buzzer Duration	Abd	0: Buzzer is off [0, 999]: Buzzer will continue for the time set by the parameter in minutes in which process the sound format is such as "iiiiiiii"_____ 999: Buzzer continues for ever with "iiiiiiii"_____ and so on	0	0	999	min	
	Auto Clearance of Alarm	ACA	no: Disable this function; alarm status will not disappear automatically without acknowledge by user even if the alarm recovers yES: Enable this function; alarm status can change from active to inactive automatically on condition that the alarm recovers (Errors are always auto-clearance enabled)	yES	no	yES		
<b>Auto-Heater Control</b>	<b>AHC</b>	<b>AHC</b>	<b>Main menu for Street cooler settings (Street-Cooler : Coolers placed in the street with frost protection )</b>					
	Automatic heater mode enable	AuH	yES: Heater will be active if air-temperature is too low no: Normal operation	no	no	yES		
	Energy mode delay	End	Delay between heater and compressor operation	60	0	360	min	
	Auto Heat set point	AHS	Heater Set point: the set point of auto heating	2.0	-100.0	200.0	°C	
	Auto heat differential	AHd	Thermostat differential for auto heating	2.0	0.0	20.0	K	
<b>ECO strategy</b>	<b>ECS</b>	<b>ECS</b>	<b>Main menu for ECO strategy</b>					
	ECO on / off	ECO	ECO active or not if no all other settings are not active	yES	no	yES		
	Door Actions	EdA	Times of door action to trigger exiting ECO (Only can be accessed by Danfoss)	1	1	10		
	Pir Actions	EPA	Times of PIR action to trigger exiting ECO (Only can be accessed by Danfoss)	1	1	10		
	Action counter time	ECT	Door action or PIR action within action counter time can trigger exiting ECO (Only can be accessed by Danfoss)	30	0	180	min	
	Door delay	Edd	Door delay after door close to trigger entering ECO (Only can be accessed by Danfoss)	180	0	180	min	
	Pir delay	EPd	PIR delay to trigger entering ECO (Only can be accessed by Danfoss)	120	0	180	min	
	Shop Light Day	Sld	Shop light level during opening hours When above this level ECO mode is canceled Disabled if no light sensor connected/assigned	5	0	80		
	Shop Light Night	SLn	Shop light level during closing hours When below this level ECO mode is enabled Disabled if no light sensor connected/assigned	3	0	80		
	Time to pull down	tto	Time which ERC stay in ECO and holiday mode to decide to enter Pull down or Serving mode	0	0	168	hour	
	Light Source delay on ECO	LSd	Time delay for light source to change from serving mode source to ECO mode source	0	0	180	min	
	EWU active on / off	Euu	Enable or disable early wake up	yES	no	yES		
	Shop close hour	CLH	Shop is assumed to be closed when staying in ECO mode longer than shop close hour	6	0	24	hour	
	Early wake up time offset	ErL	Time of exiting ECO mode for next day: Time of first activity to exit ECO mode - the Early wake-up time 0: Early wake up function disabled	120	0	240	min	
	Holiday Length	HoL	In case that no activity has been registered for a number of days specified by the Holiday, the Early-wake-up is deactivated and the cooler must stay in Holiday mode until activity is detected	72	0	999	hour	
<b>ECO manag.</b>	<b>ECA</b>	<b>ECA</b>	<b>Main menu for ECO management</b>					
	ECO Temperature Offset	Eto	If this offset is below zero, it means that Night mode will be activated instead of ECO mode	4.0	-25.0	25.0	K	
	Holiday Temperature Offset	Hto	Increase or decrease of temperature with respect to normal mode during Holiday mode	6.0	-25.0	25.0	K	
	ECO Differential	diE	Thermostat differential for ECO	2.0	0.0	10.0	K	
	ECO Fan on cycle	FoE	On time for fan during compressor off period in ECO mode	0	0	960	Sec	
	ECO Fan stop cycle	FSE	Off time for fan during compressor off period in ECO mode	0	0	960	Sec	
	ECO Cabinet light control	ELC	on: Always ON (Button is default to control light for all these options) oFF: Always OFF dor: Door sensor only	on	on	dor		
	Eco Light delay	ELd	Delay from shop light is turned on or off till mode shift is allowed	5	0	10	min	
<b>Assign.</b>	<b>ASI</b>	<b>ASI</b>	<b>Assignment of inputs and outputs</b>					
	MODBUS Safety	uSA	no: MODBUS auto detection is enabled yES: MODBUS communication is deactived	no	no	yES		
	Temp Adj. for S1	t1A	Adjust value for sensor1 before being used by application	0.0	-20.0	20.0	K	
	Temp Adj. for S2	t2A	Adjust value for sensor2 before being used by application	0.0	-20.0	20.0	K	

Menu	Parameter name	Menu code	Description	Def	Min	Max	Unit	Current setting
	Temp Adj. for S3	t3A	Adjust value for sensor3 before being used by application	0.0	-20.0	20.0	K	
	Temp Adj. for S4	t4A	Adjust value for sensor4 before being used by application	0.0	-20.0	20.0	K	
	S1/S2/S3 Config	S1C S2C S3C	Sensor type used for sensor input 1/2/3 Stn: Standard NTC 5k @ 25 °C (EKS211) in Celsius Htn: High temperature NTC 100k @ 25 °C in Celsius Ldr: Light sensor(LDR), Luminens dig: Digital input. On / Off	Stn	Stn	dig		
	S4 Config	S4C	Stn: Standard NTC 5k @ 25 °C (EKS211), in Celsius Htn: High temperature NTC 100k @ 25 °C, in Celsius Pt1: PT1000 sensor 1000K @ 0 °C, in Celsius Ldr: Light sensor(LDR), Luminens dig: Digital input. On / Off	Stn	Stn	dig		
	S1/S2/S3 Application	S1A S2A S3A	Select the function to be controlled via the Sensor 1 / 2 / 3 nC: Not connected SCo: Temperature control EuA: Evaporator temperature Con: Condenser temperature (Condenser cleaning) AuS: Only for showing temperature on display Ldr: Light sensor (LDR), Luminens ECo: External input to control ECO mode doC: Door contact. Contact closed when door closed doo: Door contact. Contact open when door closed	SCo	nC	doo		
	S4 Application	S4A	Select the function to be controlled via the Sensor 4 input nC: Not connected SCo: Temperature control EuA: Evaporator temperature Con: Condenser temperature (Condenser cleaning) AuS: Only for showing temperature on display Ldr: Light sensor (LDR), Luminens ECo: External input to control ECO mode doC: Door contact. Contact closed when door closed doo: Door contact. Contact open when door closed bt5: Button5	nC	nC	bt5		
	DI Config	diC						