

Cascade HC/HFC - CO₂ system

How to control the system

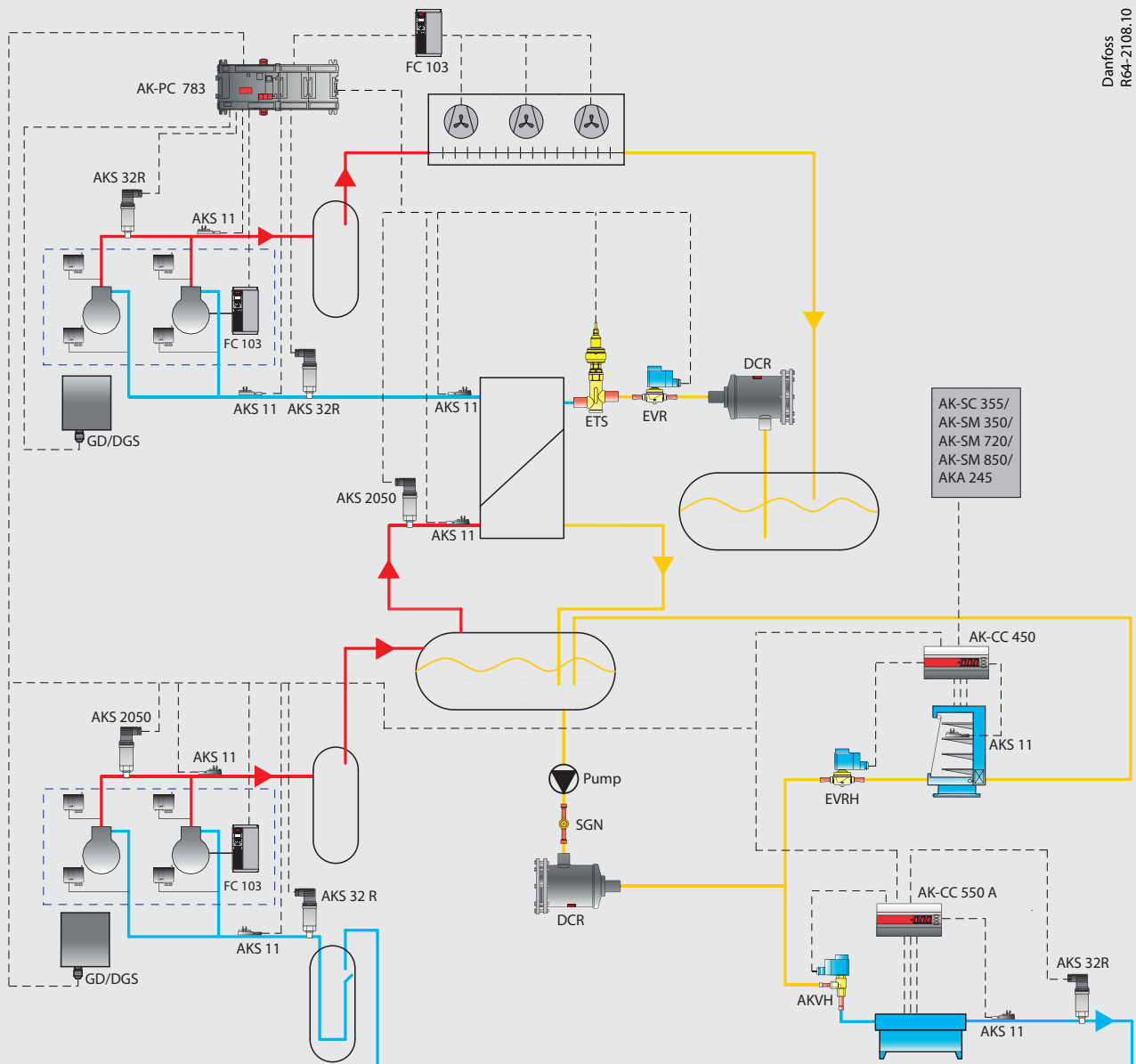

Danfoss
R64-2108.10

General description

A cascade system combines the benefit of CO₂ and HFC's. Cascades is a very attractive alternative to a traditional system in climate that are not suitable for trans critical CO₂ systems. A cascade system offers the possibility to build CO₂ systems with pressures below 40 Bar. The GWP is reduced significant to a traditional R134/404A system. Cascade systems gives a number of advantages:

- Efficiency of the system is high in the hot climates
- Only a small amount of refrigerant is needed for high temperature stage
- Temperature difference for cascade heat exchanger is relatively low
- On the high side various refrigerants can be used ex HC/HFC.

For the HFC that is used at a high temperature stage, R134a is a preferable option due to its thermo dynamical properties and lower (compared to R404A) GWP potential.

Temperatures and pressures in cascade systems

Intermediate temperature in a cascade system is selected based on the required temperature for high temperature cases in a store which means they can be cooled by CO₂ directly. Intermediate temperature can also be optimized for the highest energy efficiency if the system is used for low temperature only.

Since a cascade system actually consists of two different refrigeration systems which are connected, but isolated at the cascade heat exchanger, the design working pressure for each can be different. CO₂ design pressure is normally based on the availability of components and is equal to 40-45 bar (corresponding to +5 - +10°C).

In order to prevent pressure from increasing above the previously mentioned measurements, stand still systems are recommended. Safety valves should have the highest setting. Stand still pressure can be achieved by raising the design pressure to 80-90 bar.

For example:

- CO₂ side
- System design working pressure (saturated suction temperature): 42 bar (+5°C)
- Safety valve settings: 42 bar (+5°C) (-10% MWP)
- System emergency relief setting: 34 bar (-1°C)
- CO₂ discharge pressure setting: 35 bar (0°C)

The higher the efficiency of the cascade heat exchanger, the lower the difference between the condensation temperature of CO₂ and the evaporating temperature of the refrigerant on the high temperature side. As the temperature difference on the cascade condenser increases, the overall efficiency of the refrigeration system decreases!

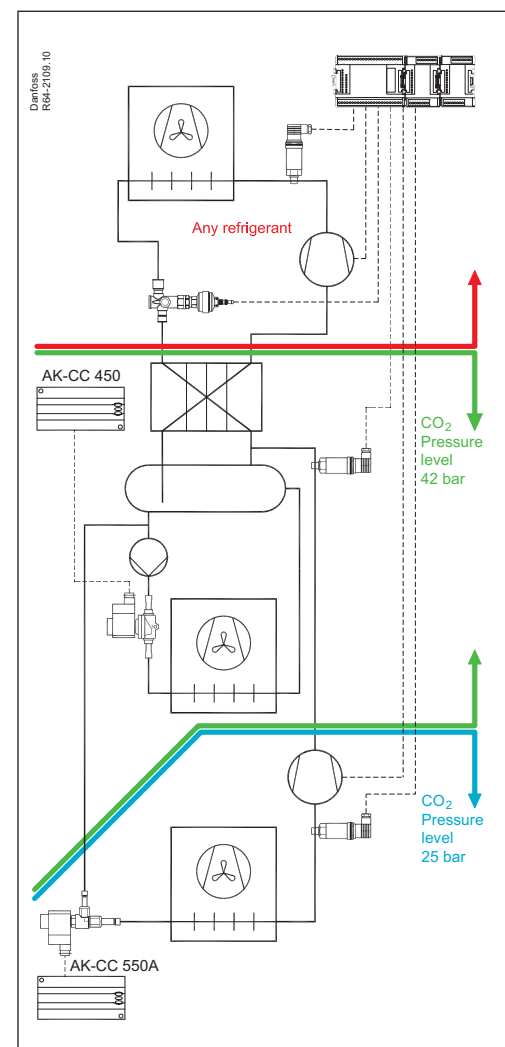

Temperatures and pressures in cascade systems (continued)

If a CO₂ system has high superheat, then desuper-heaters need to be used in order to reduce the load on the high temperature side.

Optimal intermediate pressure in CO₂ cascade systems depends on a number of parameters (high temperature refrigerant, load pattern etc.). Generally 2 cases need to be considered:

1) Systems with load at the medium temperature. In this case intermediate pressure should be as high as possible in order to reduce the load at the high temperature stage. The limitations are therefore required temperature on the intermediate level and pressure rating of the system.

2) Systems without load at medium temperature. In this case the intermediate temperature should be in the range of -10 - 0°C (due to the high pressure of the CO₂ LT) where lower limit is defined by efficiency and higher by system pressure rating

Operating sequence of cascade systems

In Cascade Systems, it is essential that at least one compressor in the high temperature side is running before the first compressor in the low temperature side can start. Otherwise, the compressor in the low temperature side may be cut out due to high pressure.

The same sequence is also valid for charging the system. First of all, the high temperature circuit needs to be filled with refrigerant and started up. When this is done, the CO₂ can be charged into the low temperature system.

The high temperature expansion valve (ETS) to the cascade heat exchanger should start simultaneously with the high temperature compressors. After this, the valve controls the superheat of the high temperature gas. LT compressors are then started up by the CO₂ pressure increase on the suction line.

Danfoss pack controller AK-PC 783 is specially designed with built in control functions to coordinate these operations.

Injection into cascade heat exchanger

Injecting liquid into a plate heat exchanger is not a trivial matter. The heat exchanger is often compact and therefore the time constant is very low. AKV valves are not recommended for this application.

It is recommended to use motor valves (ETS or CCM) or other valves that give constant flow.

Desuper-heating of CO₂ gas entering the cascade heat exchanger can also be recommended for three reasons.

- The gas is often 60°C and therefore the heat can be rejected to the ambient or used for heat recovery without problems.
- To reduce thermal stress in the heat exchanger.
- CO₂ gas gives very high heat fluxes which therefore create unstable conditions on the evaporation side. Therefore it is recommended to reduce the superheat on the CO₂ side.

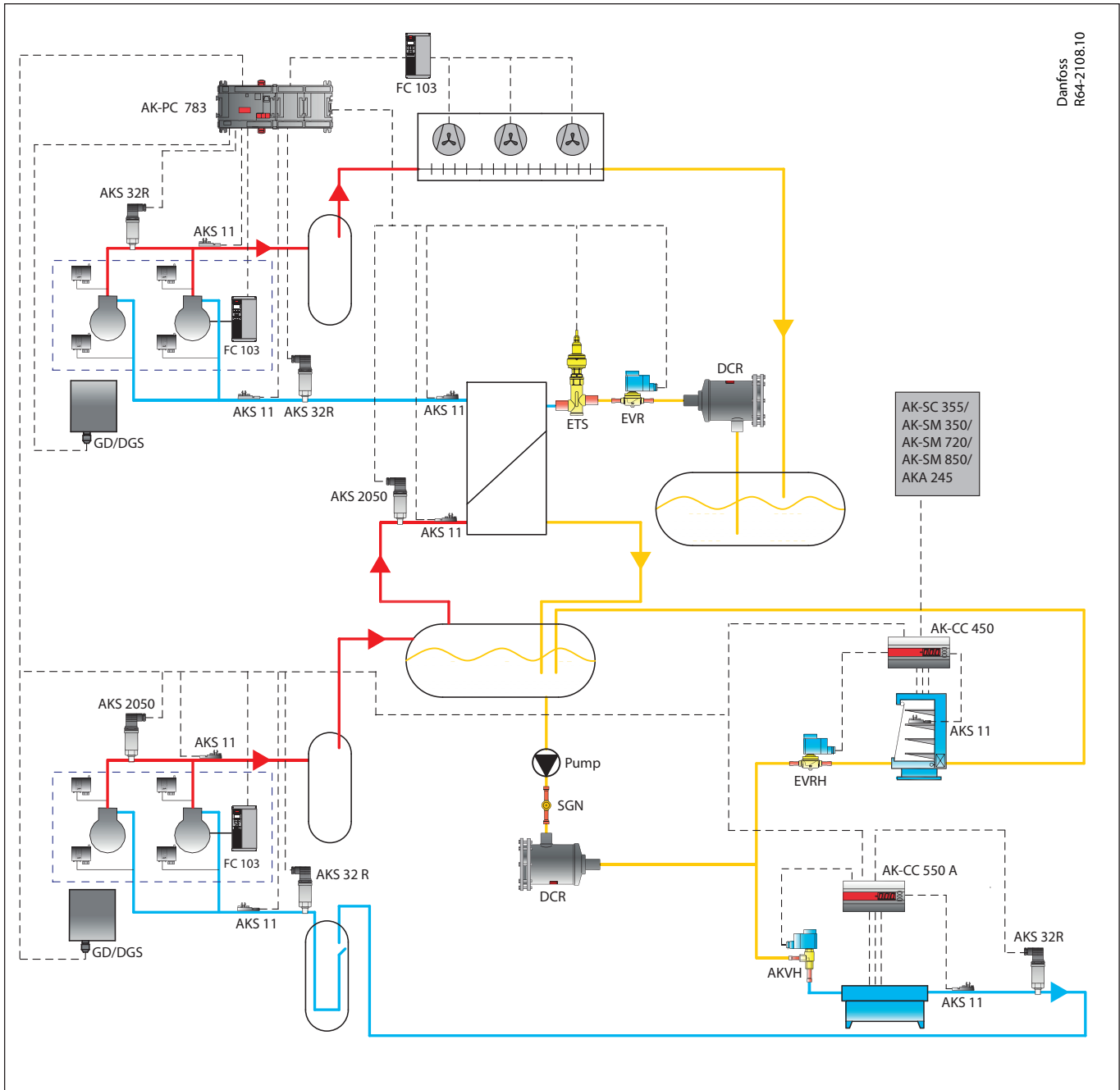

Danfoss
R64-2108.10

Cascade HFC - CO₂ system

Controls of Cascade system

Control of cascade systems can be divided into:

- Condenser capacity control
- Compressor capacity control
- Cascade injection control

Condenser capacity control

Capacity control of the condenser can be accomplished via step regulation or speed control of the fans.

As regulating sensor for the capacity distributor the condenser pressure should be selected. The reference for the regulation can be defined in two ways. Either as a fixed reference or as a reference that varies according to the outdoor temperature. The reference for the condensing pressure is set in °C (°F).

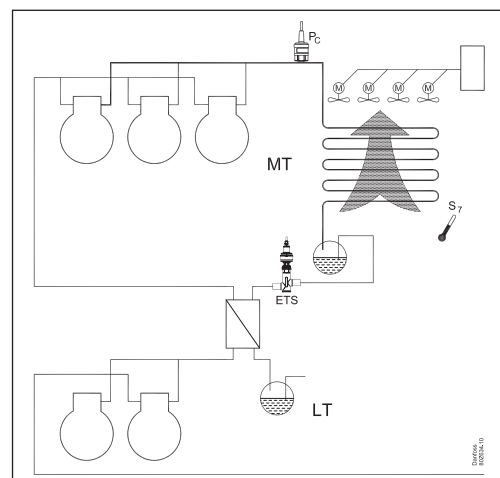

Compressor capacity controls

The AK-PC 783 is also able to coordinate the LT and MT start to ensure a smooth operation. Here the high-pressure compressors can start either as a result of:

- Load on the high-pressure circuit
- Requirements from the low-pressure circuit

The high-pressure circuit will still ensure that the low-pressure circuit is only permitted to start

when at least one high-pressure compressor has started. It will also ensure that security timers and compressor timers are complied with.

Low-pressure / high-pressure coordination

The AK-PC 783 is also able to coordinate the LT and MT start to ensure a smooth operation. Here the high-pressure compressors can start either as a result of:

- Load on the high-pressure circuit
- Requirements from the low-pressure circuit

The high-pressure circuit will still ensure that the low-pressure circuit is only permitted to start when at least one high-pressure compressor has started. It will also ensure that security timers and compressor timers are complied with.

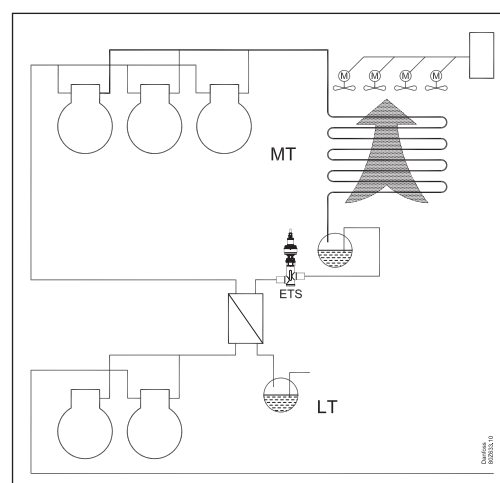

Oil Management / Oil equalisation

The build in oil management system covers most systems found on the market today. Can be used with CO₂ as well as all other conventional refrigerants and support input signals from :

- Level switch on compressor
- Level switch on oil separator
- Level switch on oil receiver
- Pressure transmitter on oil receiver

Oil supply to the compressors can be managed by the AK-PC 783 controller.

Cascade injection control

In systems with cascade regulating and CO₂ as refrigerant on the low temperature circuit AK-PC 783 can regulate liquid injection (by means of an ETS stepper expansion valve) into the cascade heat exchanger in one of two ways:

- Optimize superheat
- Regulate the condensation pressure at the low temperature circuit while ensuring that the superheat does not become too low.

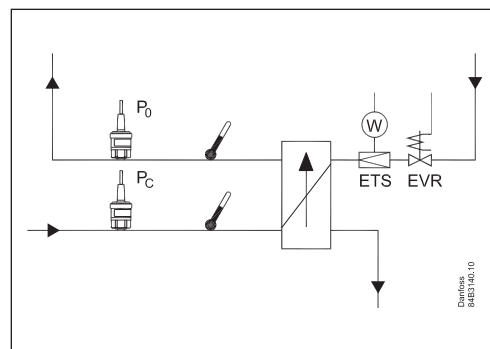

MT evaporator CO₂ flow control

The air temperature in the medium temperature display cases or rooms is controlled by opening/closing a solenoid valve/motor valve in the CO₂ supply to the evaporator. The actual temperature control can take place in two ways: as ordinary ON/OFF regulation with a differential, or as modulating control (PWM) where the temperature variation will not be nearly as big as in ON/OFF control.

In a system with several evaporators supplied by the same CO₂ liquid pump, modulating temperature control should be chosen as this also provides a more constant flow of CO₂ to the CO₂ pump.

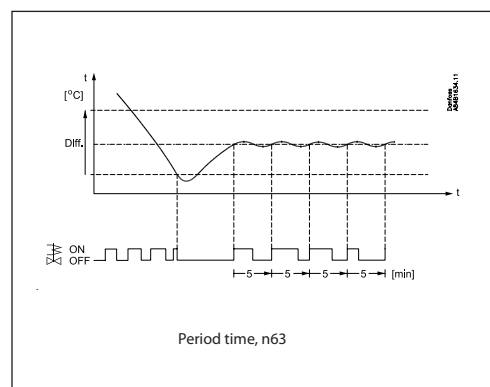

LT evaporator injection control

Injection control for the low temperature case and cold room evaporators is an AK-CC 550A utilizing pulse-width-modulating injection valves AKVH and patented adaptive software algorithms to optimise system performance and operation.

Pressure control

The Danfoss CO₂ controllers have more pressure safety functions which prevents safety valves to open and hereby loss of charge.

AK-PC 783 pack controller
A max compressor discharge pressure safety function will reduce compressor capacity.

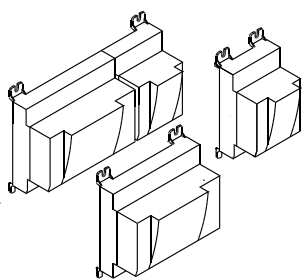

AK-PC 783

Flexible controller for full cascade control. Number of I/O can be extended with AK-XM extension modules.

- Max 4 compressors on LT (CO₂)
- Max 4 compressors on MT (134a)
- Full control of cascade condenser (ETS valve)
- Max 8 steps on MT condenser
- Variable speed control on lead compressor for LT, MT and condenser fans
- Build in oil Management functions
- Release-request function for coordination between high-pressure and low-pressure compressors.
- Simple heat reclaim function

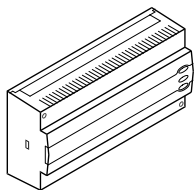

AK-CC 450

Complete refrigeration appliance control with great flexibility to adapt to all types of refrigeration appliances and cold storage rooms.

- For cooling with brine or pumped CO₂
- For use with a thermostatic expansion valve.
- Energy optimisation of the whole refrigeration appliance
- One controller for several different refrigeration appliances
- Natural, electric or hot gas defrost

AK-CC 550A

As AK-CC 450 +

- For cooling with Electronic expansion valve
- Adaptive control of superheat
- Adaptive defrosting based on evaporator performance
- Especially designed for CO₂ applications

AK-CC 550B

As AK-CC 550A +

- Control for 2 sections in 1 case

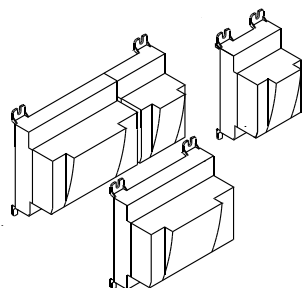

AK-CC 750

Flexible refrigeration appliance controller for control of up to 4 evaporators.

- Also now available for ETS.

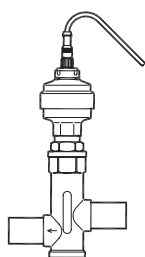

ETS

ETS is a series of electrically operated (step-motor) expansion valve

- Electrically operated expansion valves for precise liquid injection in evaporators
- Fully balanced, providing bi-flow feature as well as solenoid tight shut-off function in both flow directions.

