

Instructions



037C3005

037C3005

Terminal space adaptor for UL 508E conformity DCP-, BBT-

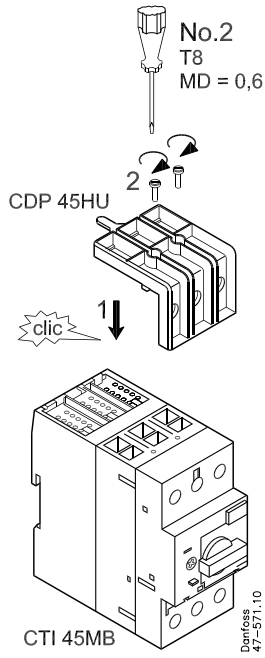
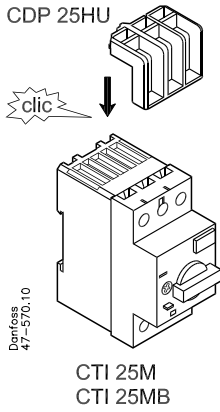
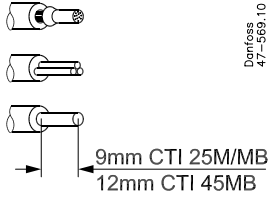

Attention: To prevent electrical shock, disconnect from power source before installing or servicing. Install in suitable enclosure. Keep from contaminants.

 IEC 60947; EN 60947
UL 508; CSA 22.2 Part 14

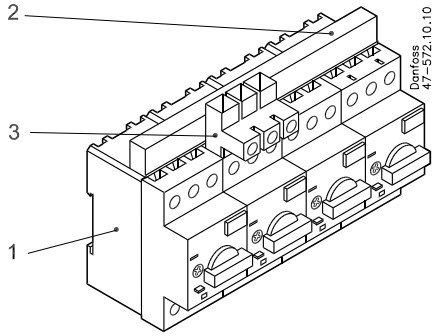



	64 A max. IEC UL 508, type E	120 A max. IEC UL 508, type E
1		CTI 45 MB
2	BBC 25	BBC 45
3	BBT 25HU	BBT 45HU

	BBT 25HU	BBT 45HU
   13mm BBT 25HU 16mm BBT 45HU	Danfoss 47-573.10 1 x 1.5 ... 16 mm ² 1 x 1.5 ... 25 mm ² No. 14 ... 4 AWG 1 x 1.5 ... 25 mm ² No. 14 ... 4 AWG	 1 x 4 ... 50 mm ² No. 12 ... 1/O AWG 1 x 4 ... 50 mm ² No. 12 ... 1/O AWG
	3 ... 3.5 Nm 27 ... 31 lb-in	5 ... 6 Nm 45 ... 54 lb-in