

NF9FX Standard Compressor R134a 115-127V 60Hz



General

Code number	105G5920
Approvals	UL984
Compressors on pallet	80

Application

Application	LBP/MBP			
	Hz	50	60	
Frequency	Hz	50	60	
Evaporating temperature	°F	-	-20 to 45	
Voltage range	V	-	95 - 135	
Max. condensing temperature continuous (short)	°F	-	140 (158)	
Max. winding temperature continuous (short)	°F	-	257 (275)	

Cooling requirements

Frequency	Hz	50			60		
		LBP	MBP	HBP	LBP	MBP	HBP
90°F		-	-	-	F ₂	F ₁	-
100°F		-	-	-	F ₂	F ₁	-
110°F		-	-	-	F ₂	F ₁	-
Remarks on application:							

Motor

Motor type	CSIR		
LRA (rated after 4 sec. UL984), HST LST	A	28.0	-
Cut in Current, HST LST	A	28.0	-
Resistance, main start winding (77°F)	Ω	1.9	6.6

Design

Displacement	cu.in	0.51
Oil quantity (type)	fl.oz.	10.8 (polyolester)
Maximum refrigerant charge	oz.	17.5
Free gas volume in compressor	fl.oz.	79.7
Weight without electrical equipment	lbs.	22.0

Dimensions

Height	inch	A	7.76
		B	7.52
Suction connector	location, I.D. in. angle	C	0.320-0.327 15°
		material comment	Cu-plated steel Rubber plug
Process connector	location, I.D. in. angle	D	0.252-0.259 25°
		material comment	Cu-plated steel Rubber plug
Discharge connector	location, I.D. in. angle	E	0.252-0.259 35°
		material comment	Cu-plated steel Rubber plug
Oil cooler connector	location, I.D. in. angle	F	-
		material comment	-
Remarks:			

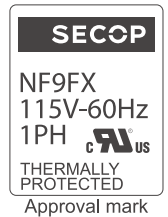
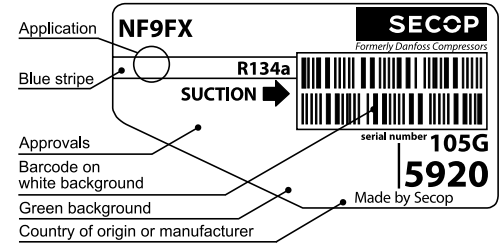

- S = Static cooling normally sufficient
- O = Oil cooling
- F₁ = Fan cooling 1.5 m/s (compressor compartment temperature equal to ambient temperature)
- F₂ = Fan cooling 3.0 m/s necessary
- SG = Suction gas cooling normally sufficient
- = not applicable in this area

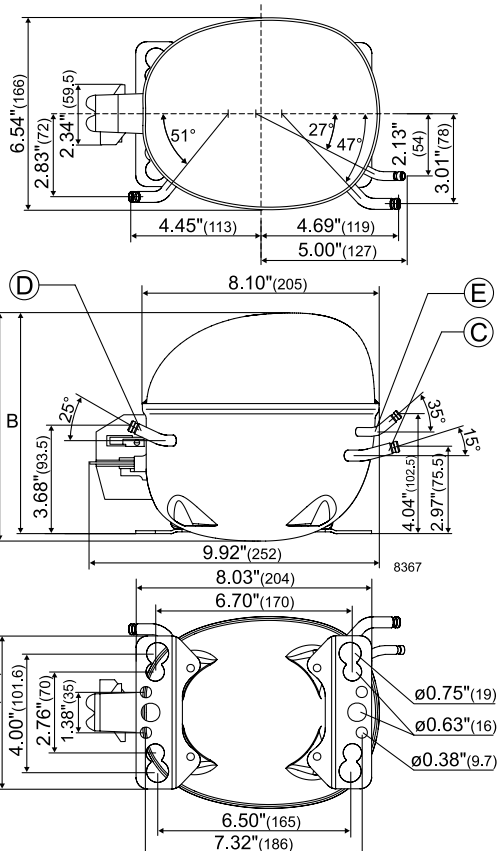

ASHRAE LBP

115V, 60Hz, fan cooling F₁

Evap. temp. in °F	-49	-40	-30	-20	-13	-10	0	10	14	20	30	32	40	45	50	59	68
Capacity in BTU/h				674	851	935	1261	1662	1852	2148	2731	2868	3420	3808			
Power cons. in W				213	235	245	277	311	325	347	386	394	429	452			
Current cons. in A				3.32	3.44	3.50	3.69	3.92	4.01	4.17	4.45	4.50	4.75	4.91			
EER in BTU/Wh				3.17	3.62	3.82	4.55	5.34	5.69	6.19	7.07	7.30	7.98	8.43			

ASHRAE MBP

115V, 60Hz, fan cooling F₁

Evap. temp. in °F	-49	-40	-30	-20	-13	-10	0	10	14	20	30	32	40	45	50	59	68
Capacity in BTU/h				599	756	831	1121	1476	1647	1907	2422	2547	3031	3374			
Power cons. in W				213	235	245	277	311	325	347	386	394	429	452			
Current cons. in A				3.32	3.44	3.50	3.69	3.92	4.01	4.17	4.45	4.50	4.75	4.91			
EER in BTU/Wh				2.82	3.22	3.40	4.04	4.75	5.08	5.49	6.28	6.48	7.07	7.47			

EN 12900 Household (CECOMAF)

115V, 60Hz, fan cooling F₁

Evap. temp. in °F	-49	-40	-30	-20	-13	-10	0	10	14	20	30	32	40	45	50	59	68
Capacity in W				160	202	222	299	394	437	509	646	677	809	900			
Power cons. in W				213	235	245	277	311	326	347	386	395	429	452			
Current cons. in A				3.32	3.44	3.50	3.69	3.92	4.02	4.17	4.45	4.51	4.75	4.91			
COP in W/W				0.75	0.86	0.91	1.08	1.26	1.34	1.46	1.67	1.71	1.88	1.99			

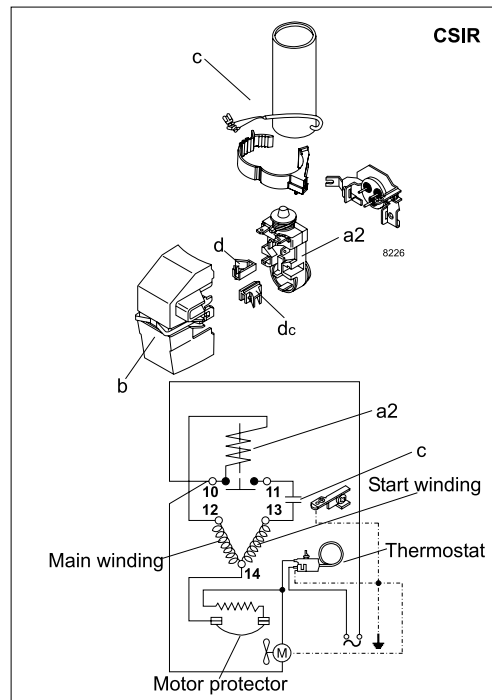

Accessories for	NF9FX	Figure	Code number
Starting relay	1/4 in. spade connect.	a2	117U4129
Protector 3/4 in.	Texas Instruments		MRT22AFZ-6
Start. capacitor 280 µF	1/4 in. spade connect.	c	117U5025
Cover		b	117U1021
Cord relief		d	117U0349
Cord relief for capacitor		dc	117U0349

Test conditions	ASHRAE LBP	ASHRAE MBP	EN 12900/CECOMAF
Condensing temp.	130°F	130°F	131°F
Ambient temp.	90°F	95°F	90°F
Suction gas temp.	90°F	95°F	90°F
Liquid temperature	90°F	115°F	131°F

Mounting accessories		Code number
Bolt joint for one comp.	Ø: 5/8 in.	118-1917
Bolt joint in quantities	Ø: 5/8 in.	118-1918
Snap-on in quantities	Ø: 5/8 in.	118-1919

Danfoss can accept no responsibility for possible errors in catalogues, brochures and other printed material. Danfoss reserves the right to alter its products without notice. This also applies to products already on order provided that such alterations can be made without subsequential changes being necessary in specifications already agreed. All trademarks in this material are property of the respective companies. Danfoss and the Danfoss logotype are trademarks of Danfoss A/S. All rights reserved.