

SC15CNX LBP/MBP Compressor R290 220-240V 50Hz

General

Code number	104H8565
Approvals	EN 60335-2-34
Compressors on pallet	80

Application

Application	LBP/MBP		
Frequency	Hz	50	60
Evaporating temperature	°C	-40 to 5	-
Voltage range	V	198 - 254	-
Max. condensing temperature continuous (short)	°C	55 (65)	-
Max. winding temperature continuous (short)	°C	125 (135)	-

Cooling requirements

Frequency	Hz	50			60		
Application		LBP	MBP	HBP	LBP	MBP	HBP
32°C		F ₂	F ₂	-	-	-	-
38°C		F ₂	F ₂	-	-	-	-
43°C		F ₂	F ₂	-	-	-	-
Remarks on application:							

Motor

Motor type	CSR		
LRA (rated after 4 sec. UL984), HST LST	A	14.8	-
Cut in Current, HST LST	A	14.8	-
Resistance, main start winding (25°C)	Ω	5.0	13.7

Design

Displacement	cm ³	15.28
Oil quantity (type)	cm ³	600 (polyolester)
Maximum refrigerant charge	g	150
Free gas volume in compressor	cm ³	1410
Weight without electrical equipment	kg	13.1

Dimensions

Height	mm	A	209
		B	203
		B1	183
		B2	100
Suction connector	location/I.D. mm angle	C	8.2 37°
	material comment		Cu-plated steel Al cap
Process connector	location/I.D. mm angle	D	6.2 37°
	material comment		Cu-plated steel Al cap
Discharge connector	location/I.D. mm angle	E	6.2 37°
	material comment		Cu-plated steel Al cap
Oil cooler connector	location/I.D. mm angle	F	-
	material comment		-
Connector tolerance	I.D. mm		±0.09
Remarks:			

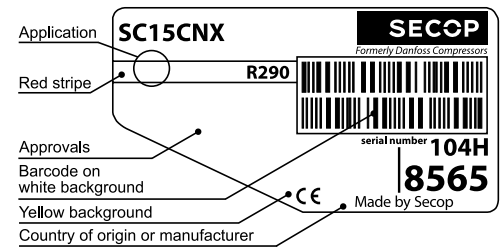

- S = Static cooling normally sufficient
- O = Oil cooling
- F₁ = Fan cooling 1.5 m/s (compressor compartment temperature equal to ambient temperature)
- F₂ = Fan cooling 3.0 m/s necessary
- SG = Suction gas cooling normally sufficient
- = not applicable in this area

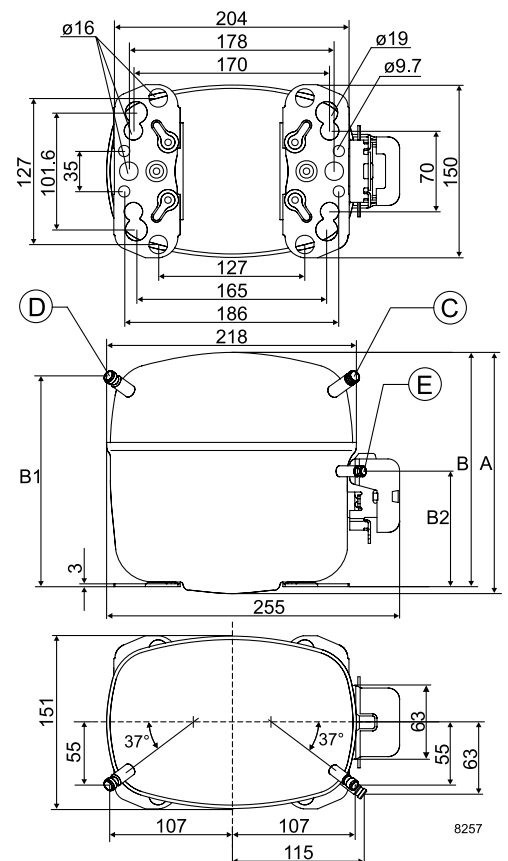

EN 12900 Household (CECOMAF)* 220V, 50Hz, fan cooling F₂

Evap. temp. in °C	-45	-40	-35	-30	-25	-23.3	-20	-15	-10	-6.7	-5	0	5	7.2	10	15	20
Capacity in W		195	297	415	550	601	707	887	1093	1245	1328	1594	1894				
Power cons. in W		256	315	370	420	436	467	514	560	592	608	659	715				
Current cons. in A		1.28	1.55	1.82	2.08	2.17	2.33	2.58	2.82	2.97	3.05	3.27	3.49				
COP in W/W		0.76	0.94	1.12	1.31	1.38	1.51	1.73	1.95	2.10	2.18	2.42	2.65				

ASHRAE LBP* 220V, 50Hz, fan cooling F₂

Evap. temp. in °C	-45	-40	-35	-30	-25	-23.3	-20	-15	-10	-6.7	-5	0	5	7.2	10	15	20
Capacity in W		217	331	462	614	671	789	991	1221	1391	1485	1784	2122				
Power cons. in W		256	315	370	420	436	467	514	560	592	608	659	715				
Current cons. in A		1.28	1.55	1.82	2.08	2.17	2.33	2.58	2.82	2.97	3.05	3.27	3.49				
COP in W/W		0.85	1.05	1.25	1.46	1.54	1.69	1.93	2.18	2.35	2.44	2.71	2.97				

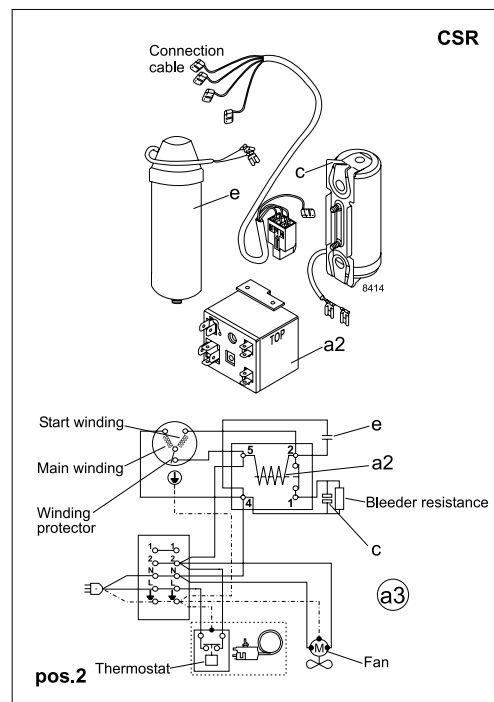
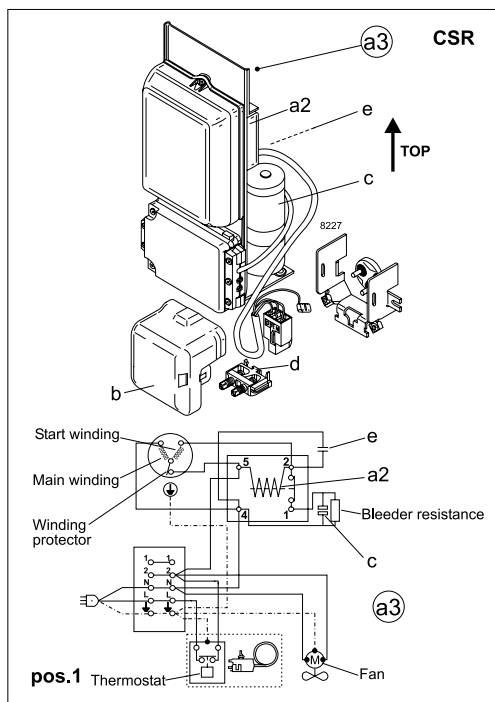

Accessories for	SC15CNX	Figure	Code number
Starting device	470 mm cable length	a3 (pos.1)	117-7051
Starting device (kit)	1020 mm cable length	(pos.2)	117-9711
Starting relay		a2	Components of starting device
Start. capacitor		c	
Run capacitor		e	
Cover		b	103N2009
Cord relief		d	103N1004

Test conditions	EN 12900/CECOMAF*	ASHRAE LBP*
Condensing temperature	45°C	45°C
Ambient temperature	32°C	32°C
Suction gas temperature	32°C	32°C
Liquid temperature	no subcooling	32°C

Mounting accessories	Code number	
Bolt joint for one comp.	Ø: 16 mm	118-1917
Bolt joint in quantities	Ø: 16 mm	118-1918
Snap-on in quantities	Ø: 16 mm	118-1919

Danfoss can accept no responsibility for possible errors in catalogues, brochures and other printed material. Danfoss reserves the right to alter its products without notice. This also applies to products already on order provided that such alterations can be made without subsequential changes being necessary in specifications already agreed. All trademarks in this material are property of the respective companies. Danfoss and the Danfoss logotype are trademarks of Danfoss A/S. All rights reserved.