

Datasheets

DLE7.5CN Energy-optimized LBP/MBP R290 220-240V 50Hz

General

Code number	102H4853
Approvals	EN 60335-2-34 w. Annex AA
Compressors on pallet	100

Application

Application	LBP/MBP		
	Hz	50	60
Frequency	Hz	50	60
Evaporating temperature	°C	-35 to 7.2	-
Voltage range	V	198 to 254	-
Max. condensing temperature continuous (short)	°C	55 (65)	-
Max. winding temperature continuous (short)	°C	125 (135)	-

Cooling requirements

Frequency	Hz	50			60		
		LBP	MBP	HBP	LBP	MBP	HBP
32°C		F ₂	F ₂	-	-	-	-
38°C		F ₂	F ₂	-	-	-	-
43°C		F ₂	F ₂	-	-	-	-

Remarks on application:
For evaporation temperatures higher than 0 °C do not run compressor at condensing temperatures higher 50 °C in steady state operation.

Motor

Motor type	CSIR/RSIR/RSCR		
LRA (rated after 4 sec. UL984), HST LST	A	9.3	9.2
Cut in Current, HST LST	A	9.3	14.5
Resistance, main start winding (25°C)	Ω	10.9	8.3

Design

Displacement	cm ³	7.48
Oil quantity (type)	cm ³	230 (polyolester)
Maximum refrigerant charge	g	150
Free gas volume in compressor	cm ³	1465
Weight without electrical equipment	kg	8.0

Dimensions

Height	mm	A	175
		B	169
		B1	-
		B2	-
Suction connector	location/I.D. mm angle	C	8.2 18°
	material comment		Copper Rubber plug
Process connector	location/I.D. mm angle	D	6.2 60°
	material comment		Copper Rubber plug
Discharge connector	location/I.D. mm angle	E	6.2 25°
	material comment		Copper Rubber plug
Oil cooler connector	location/I.D. mm angle	F	-
	material comment		-
Connector tolerance	I.D. mm		±0.09
Remarks:			

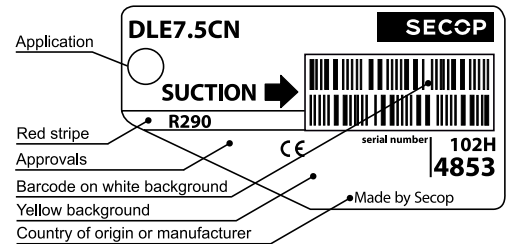

- S = Static cooling normally sufficient
- O = Oil cooling
- F₁ = Fan cooling 1.5 m/s (compressor compartment temperature equal to ambient temperature)
- F₂ = Fan cooling 3.0 m/s necessary
- SG = Suction gas cooling normally sufficient
- = not applicable in this area

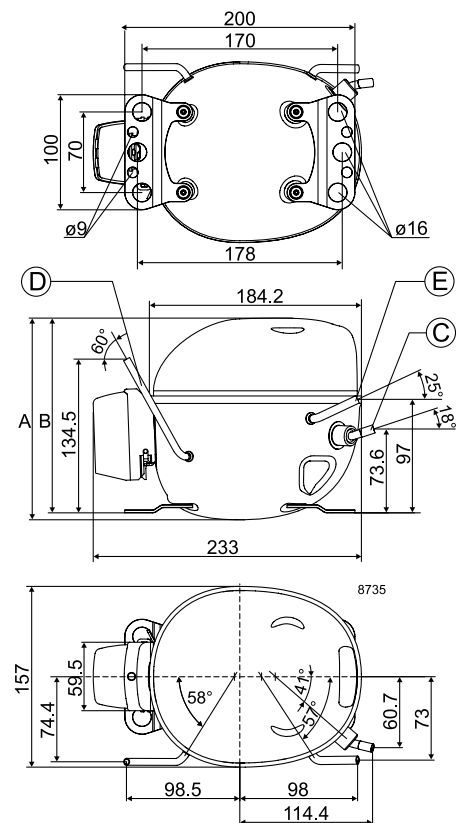

EN 12900 LBP 220V, 50Hz, CSIR/RSIR, fan cooling F₂

Evap. temp. in °C	-45	-40	-35	-30	-25	-23.3	-20	-15	-10	-6.7	-5	0	5	7.2	10	15	20
Capacity in W			212	268	336	362	417	512	623	706	752	900	1070	1151			
Power cons. in W			187	206	226	233	247	267	288	302	309	331	353	363			
Current cons. in A			1.40	1.45	1.50	1.52	1.55	1.62	1.68	1.73	1.76	1.83	1.91	1.95			
COP in W/W			1.13	1.30	1.49	1.55	1.69	1.92	2.16	2.34	2.43	2.72	3.03	3.17			

EN 12900 MBP 220V, 50Hz, CSIR/RSIR, fan cooling F₂

Evap. temp. in °C	-45	-40	-35	-30	-25	-23.3	-20	-15	-10	-6.7	-5	0	5	7.2	10	15	20
Capacity in W			198	251	315	339	390	479	583	660	703	841	1000	1076			
Power cons. in W			193	214	236	243	258	280	302	317	325	349	373	383			
Current cons. in A			1.41	1.46	1.52	1.54	1.58	1.65	1.73	1.78	1.81	1.89	1.98	2.02			
COP in W/W			1.03	1.17	1.33	1.39	1.51	1.71	1.93	2.08	2.16	2.41	2.68	2.81			

ASHRAE LBP 220V, 50Hz, CSIR/RSIR, fan cooling F₂

Evap. temp. in °C	-45	-40	-35	-30	-25	-23.3	-20	-15	-10	-6.7	-5	0	5	7.2	10	15	20
Capacity in W			209	269	339	366	422	519	633	718	765	918	1094	1179			
Power cons. in W			188	214	240	249	266	292	319	336	345	372	399	411			
Current cons. in A			1.41	1.48	1.56	1.59	1.65	1.74	1.84	1.91	1.95	2.06	2.18	2.23			
COP in W/W			1.11	1.26	1.41	1.47	1.59	1.78	1.99	2.14	2.22	2.47	2.74	2.87			

ASHRAE MBP/HBP 220V, 50Hz, CSIR/RSIR, fan cooling F₂

Evap. temp. in °C	-45	-40	-35	-30	-25	-23.3	-20	-15	-10	-6.7	-5	0	5	7.2	10	15	20
Capacity in W			187	240	303	327	377	463	564	640	682	817	973	1048			
Power cons. in W			186	212	237	246	263	289	315	332	341	368	394	406			
Current cons. in A			1.41	1.48	1.56	1.59	1.65	1.74	1.84	1.91	1.95	2.06	2.18	2.23			
COP in W/W			1.00	1.14	1.28	1.33	1.43	1.60	1.79	1.93	2.00	2.22	2.47	2.58			

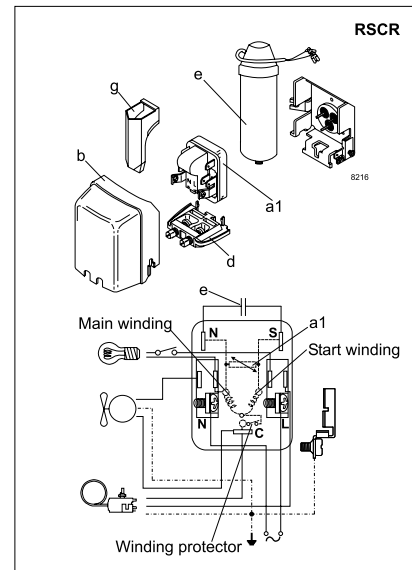
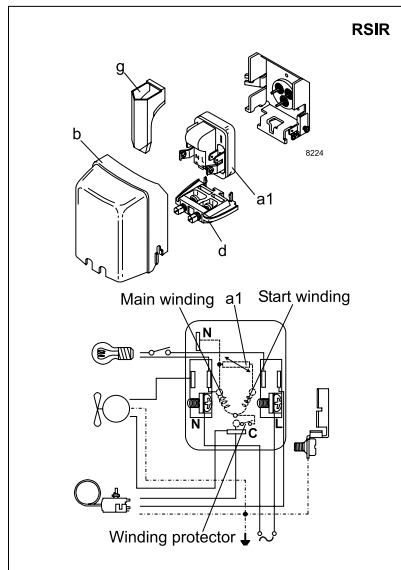
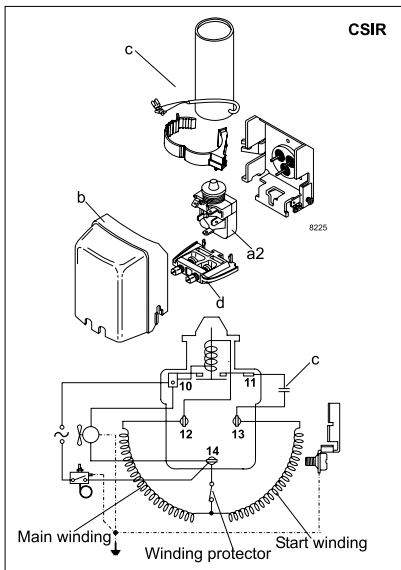

Accessories for	DLE7.5CN	Figure	Code number
PTC starting device	6.3 mm spade connectors	a1	-
	4.8 mm spade connectors		-
ePTC starting device	4.8 mm spade connectors		103N0050
Starting relay	6.3 mm spade connectors	a2	117U7002
Start. capacitor 80 µF	6.3 mm spade connectors	c	117U5015
Cover		b	103N0491
Run capacitor 5 µF (optional)	6.3 mm spade connectors	e	-
	4.8 mm spade connectors		117-7129
Cord relief		d	103N1010
Protection screen for PTC		g	-

Test conditions	EN 12900		ASHRAE	
	LBP	MBP	LBP	MBP
Condensing temperature	40°C	45°C	54.4°C	54.4°C
Ambient temperature	32°C	32°C	32.2°C	35°C
Suction gas temperature	20°C	20°C	32.2°C	35°C
Liquid temperature	no subcooling		32.2°C	46.1°C

Mounting accessories	Code number	
Bolt joint for one comp.	Ø: 16 mm	118-1917
Bolt joint in quantities	Ø: 16 mm	118-1918
Snap-on in quantities	Ø: 16 mm	118-1919

Danfoss can accept no responsibility for possible errors in catalogues, brochures and other printed material. Danfoss reserves the right to alter its products without notice. This also applies to products already on order provided that such alterations can be made without subsequent changes being necessary in specifications already agreed. All trademarks in this material are property of the respective companies. Danfoss and the Danfoss logotype are trademarks of Danfoss A/S. All rights reserved.