

VACON 100
AC DRIVES

N2 OPEN SYSTEM PROTOCOL

**INSTALLATION AND
USER'S MANUAL**

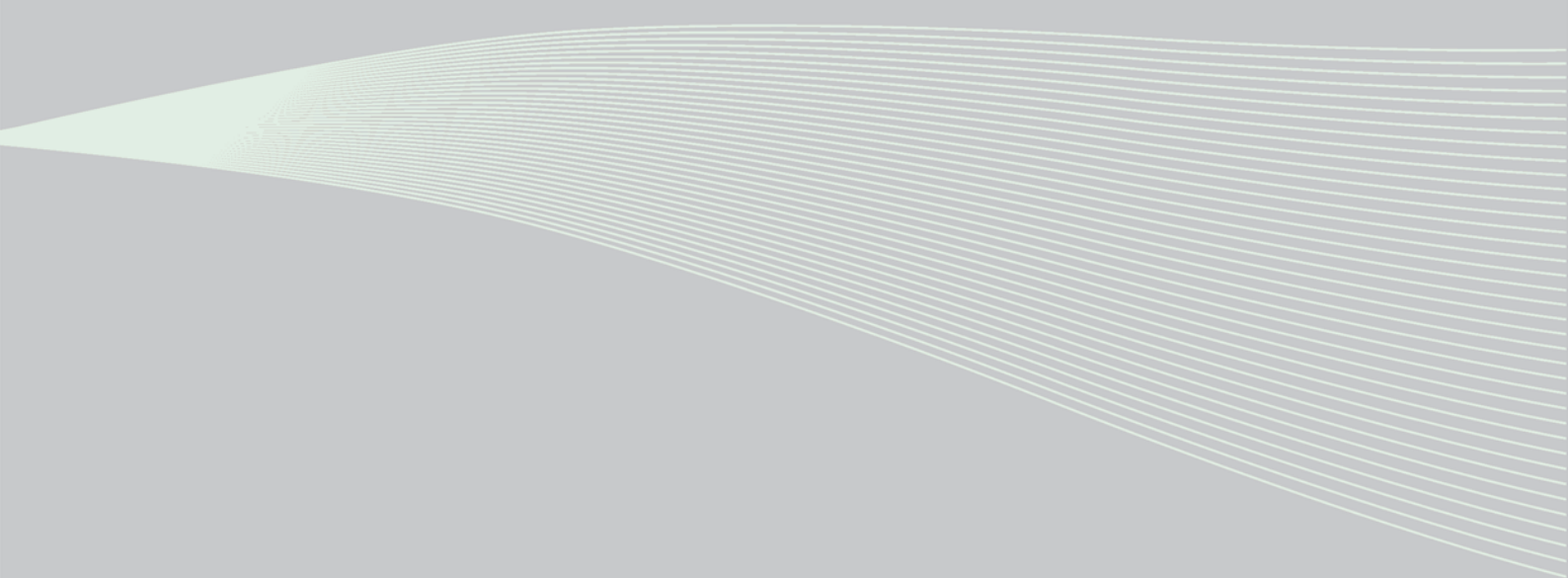

INDEX

Document: DPD00386A
Version release date: 24.9.10

1. Safety	2
1.1 Danger	2
1.2 Warnings	3
1.3 Earthing and earth fault protection	4
2. Metasys N2 - general info	5
3. N2 technical data	6
3.1 N2 protocol	6
4. N2 installation	7
4.1 Prepare for use	8
5. Programming	12
5.1 N2 parameters and monitoring values (M5.7.3)	12
5.2 N2 parameter descriptions	14
5.2.1 N2 parameters	14
5.2.2 N2 monitoring values	14
6. Communications	16
6.1 Metasys N2 interface	16
6.1.1 Analogue Input (AI)	16
6.1.2 Binary Input (BI)	17
6.1.3 Analogue Output (AO)	17
6.1.4 Binary Output (BO)	17
6.1.5 Internal Integer (ADI)	17
6.2 N2 point map	18
6.2.1 Analogue inputs (AI)	18
6.2.2 Binary Inputs (BI)	19
6.2.3 Analogue Outputs (AO)	19
6.2.4 Binary Outputs (BO)	20
6.2.5 Internal Integers (ADI)	20
7. Fault tracing	21
7.1 Typical fault conditions	21
7.2 RS-485 bus biasing	21
7.3 Other fault conditions	22
8. Quick setup	23
9. Annex	24

1. SAFETY

This manual contains clearly marked cautions and warnings which are intended for your personal safety and to avoid any unintentional damage to the product or connected appliances.

Please read the information included in cautions and warnings carefully.

The cautions and warnings are marked as follows:





	= DANGER! Dangerous voltage
	= WARNING or CAUTION

Table 1. Warning signs

1.1 DANGER

- 

The **components of the power unit of Vacon 100 are live** when the AC drive is connected to mains potential. Coming into contact with this voltage is **extremely dangerous** and may cause death or severe injury.
- 

The **motor terminals U, V, W and the brake resistor terminals are live** when Vacon 100 is connected to mains, even if the motor is not running.
- 

After disconnecting the AC drive from the mains, **wait** until the indicators on the keypad go out (if no keypad is attached see the indicators on the cover). Wait 5 more minutes before doing any work on the connections of Vacon100. Do not open the cover before this time has expired. After expiration of this time, use a measuring equipment to absolutely ensure that no voltage is present. **Always ensure absence of voltage before starting any electrical work!**
- 

The control I/O-terminals are isolated from the mains potential. However, the **relay outputs and other I/O-terminals may have a dangerous control voltage** present even when Vacon 100 is disconnected from mains.
- 

Before connecting the AC drive to mains make sure that the front and cable covers of Vacon 100 are closed.
- 

During a ramp stop (see the Application Manual), the motor is still generating voltage to the drive. Therefore, do not touch the components of the AC drive before the motor has completely stopped. Wait until the indicators on the keypad go out (if no keypad is attached see the indicators on the cover). Wait additional 5 minutes before starting any work on the drive.

1.2 WARNINGS



Vacon 100 AC drive is meant for **fixed installations only**.



Do not perform any measurements when the AC drive is connected to the mains.



The **earth leakage current** of Vacon 100 AC drives exceeds 3.5mA AC. According to standard EN61800-5-1, a **reinforced protective ground connection** must be ensured. See chapter 1.3.



If the AC drive is used as a part of a machine, the **machine manufacturer is responsible** for providing the machine with a **supply disconnecting device** (EN 60204-1).



Only **spare parts** delivered by Vacon can be used.



At power-up, power brake or fault reset **the motor will start immediately** if the start signal is active, unless the pulse control for Start/Stop logic has been selected. Furthermore, the I/O functionalities (including start inputs) may change if parameters, applications or software are changed. Disconnect, therefore, the motor if an unexpected start can cause danger.



The **motor starts automatically** after automatic fault reset if the auto restart function is activated. See the Application Manual for more detailed information.



Prior to measurements on the motor or the motor cable, disconnect the motor cable from the AC drive.



Do not touch the components on the circuit boards. Static voltage discharge may damage the components.



Check that the **EMC level** of the AC drive corresponds to the requirements of your supply network.

NOTE! You can download the English and French product manuals with applicable safety, warning and caution information from www.vacon.com/downloads.

REMARQUE Vous pouvez télécharger les versions anglaise et française des manuels produit contenant l'ensemble des informations de sécurité, avertissements et mises en garde applicables sur le site www.vacon.com/downloads.

1.3 EARTHING AND EARTH FAULT PROTECTION



CAUTION!

The Vacon 100 AC drive must always be earthed with an earthing conductor connected to the earthing terminal marked with

The touch current of Vacon 100 exceeds 3.5mA AC. According to EN61800-5-1, one or more of the following conditions for the associated protective circuit shall be satisfied:

A fixed connection and:

- a) the protective earthing conductor shall have a cross-sectional area of at least 10 mm² Cu or 16 mm² Al.

or

- b) an automatic disconnection of the supply in case of discontinuity of the protective earthing conductor.

or

- c) provision of an additional terminal for a second protective earthing conductor of the same cross-sectional area as the original protective earthing conductor.

Cross-sectional area of phase conductors [mm ²]	Minimum cross-sectional area of the corresponding protective earthing conductor [mm ²]
$S \leq 16$	S
$16 < S \leq 35$	16
$35 < S$	$S/2$

The values above are valid only if the protective earthing conductor is made of the same metal as the phase conductors. If this is not so, the cross-sectional area of the protective earthing conductor shall be determined in a manner which produces a conductance equivalent to that which results from the application of this table.

Table 2. Protective earthing conductor cross-section

The cross-sectional area of every protective earthing conductor which does not form a part of the supply cable or cable enclosure shall, in any case, be not less than:

- 5mm² if mechanical protection is provided or
- 4mm² if mechanical protection is not provided. For cord-connected equipment, provisions shall be made so that the protective earthing conductor in the cord shall, in the case of failure of the strain-relief mechanism, be the last conductor to be interrupted.

However, always follow the local regulations for the minimum size of the protective earthing conductor.

NOTE: Due to the high capacitive currents present in the AC drive, fault current protective switches may not function properly.



Do not perform any voltage withstand tests on any part of Vacon 100. There is a certain procedure according to which the tests shall be performed. Ignoring this procedure may result in damaged product.

2. METASYS N2 - GENERAL INFO

The N2 communications protocol is used by Johnson Controls and others to connect terminal unit controllers to supervisory controllers. It is open to any manufacturer and based upon a simple ASCII protocol widely used in the process control industry.

The physical characteristics of the N2 bus are three wire RS-485 with a maximum of 100 devices over a 4,000 foot distance running at 9,600 bps. Logically, the N2 is a master-slave protocol, the supervisory controller normally being the master. Data is partitioned into common HVAC control objects, such as analogue input, analogue output, binary input and binary output. N2 messaging supports the reading, writing and overriding of these points. Additionally, there are messages defined to perform uploads and downloads of devices as well as direct memory reads and writes.

3. N2 TECHNICAL DATA

3.1 N2 PROTOCOL

Connections and communications	Interface	RS-485
	Data transfer method	RS-485 MS/TP, half-duplex
	Transfer cable	STP (Shielded Twisted Pair), type Belden 9841 or similar
	Connector	2.5 mm ²
	Electrical isolation	Functional
	Metasys N2	As described in "Metasys N2 Open System Protocol Specification"
	Baud rate	9600 baud
	Addresses	1 to 255

Table 3.

4. N2 INSTALLATION

1

Open the cover of the AC drive.



The relay outputs and other I/O-terminals may have a dangerous control voltage present even when Vacon 100 is disconnected from mains.

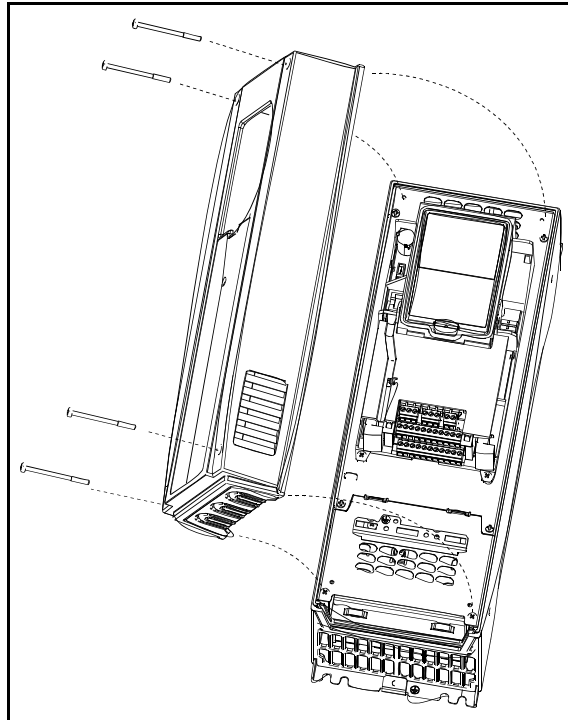

Figure 1.

2

Locate the components that you will need on the AC drive to connect and run the N2 cables.

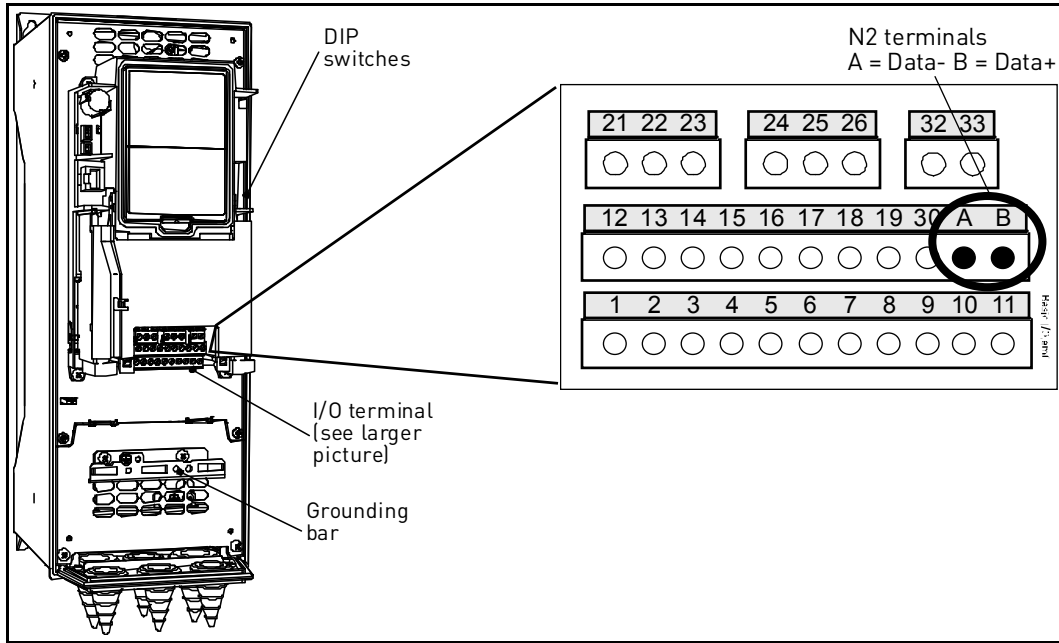

Figure 2.

4.1 PREPARE FOR USE

3

Strip about 15 mm of the N2 cable (see specification on page 6) and cut off the grey cable shield. Remember to do this for both bus cables (except for the last device).

Leave no more than 10 mm of the cable outside the terminal block and strip the cables at about 5 mm to fit in the terminals. See picture below.

Also strip the cable now at such a distance from the terminal that you can fix it to the frame with the grounding clamp. Strip the cable at a maximum length of 15 mm. **Do not strip the aluminum cable shield!**

4 Then connect the cable to its appropriate terminals on Vacon 100 AC drive standard terminal block, terminals **A and B** (A = negative, B = positive). See Figure 3.

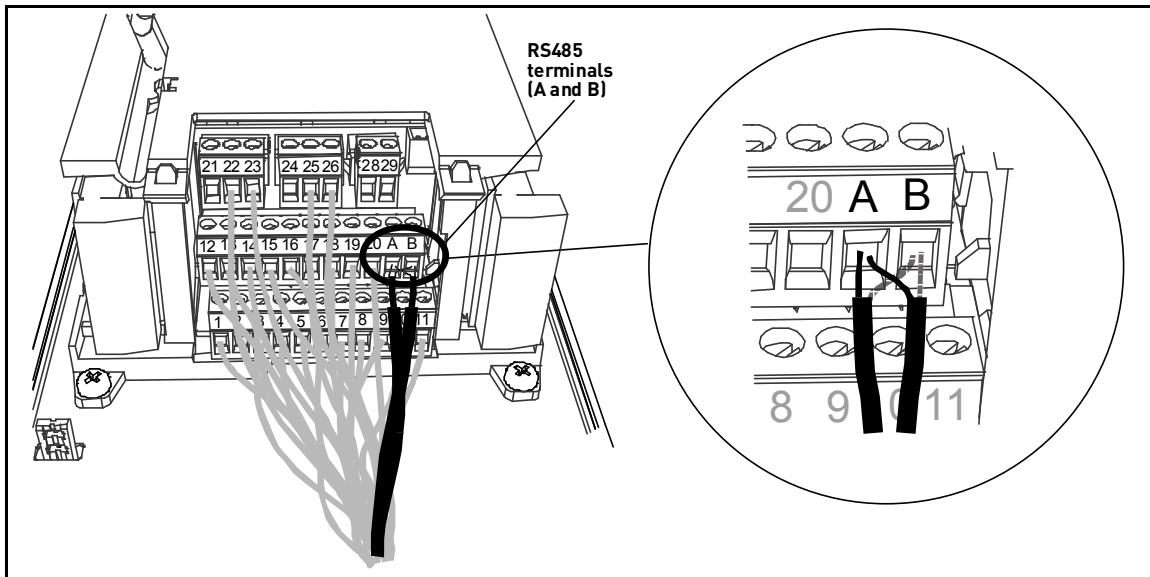
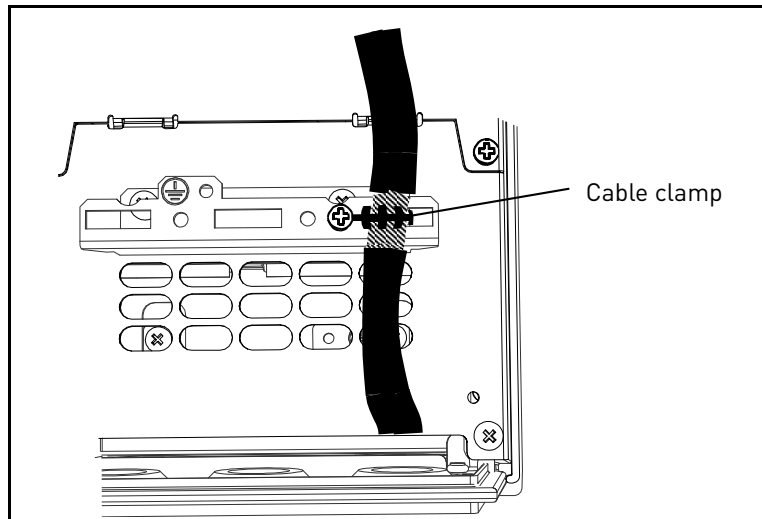
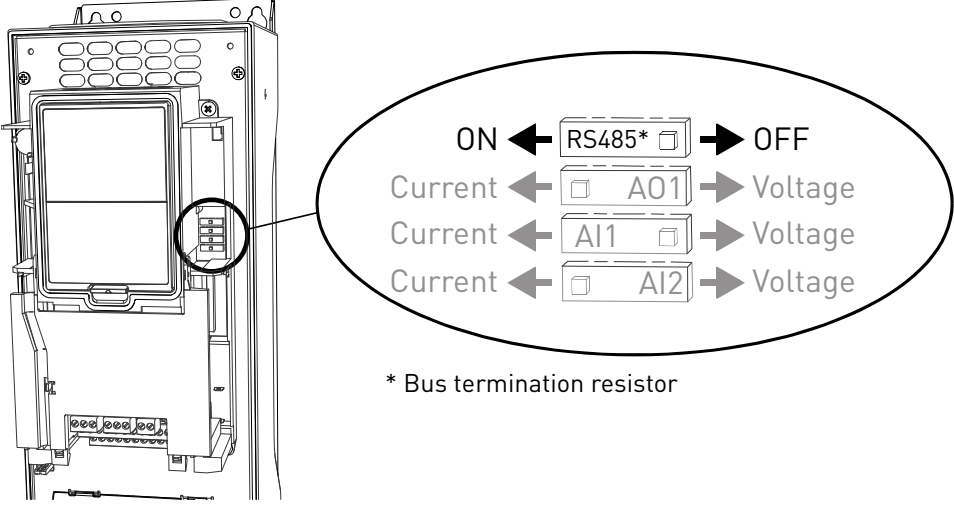
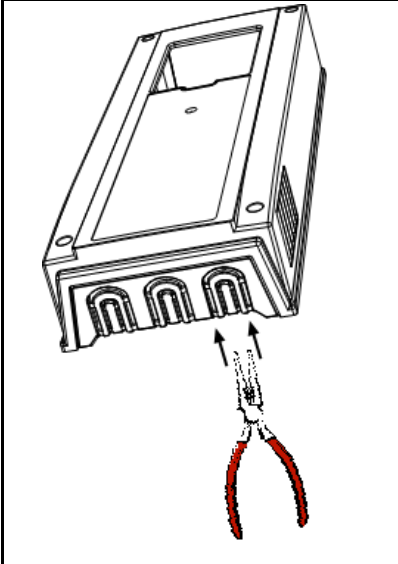
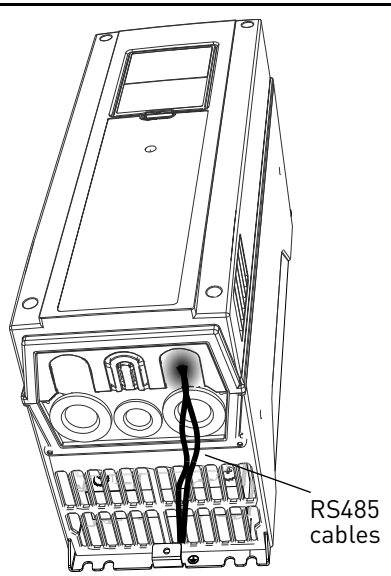
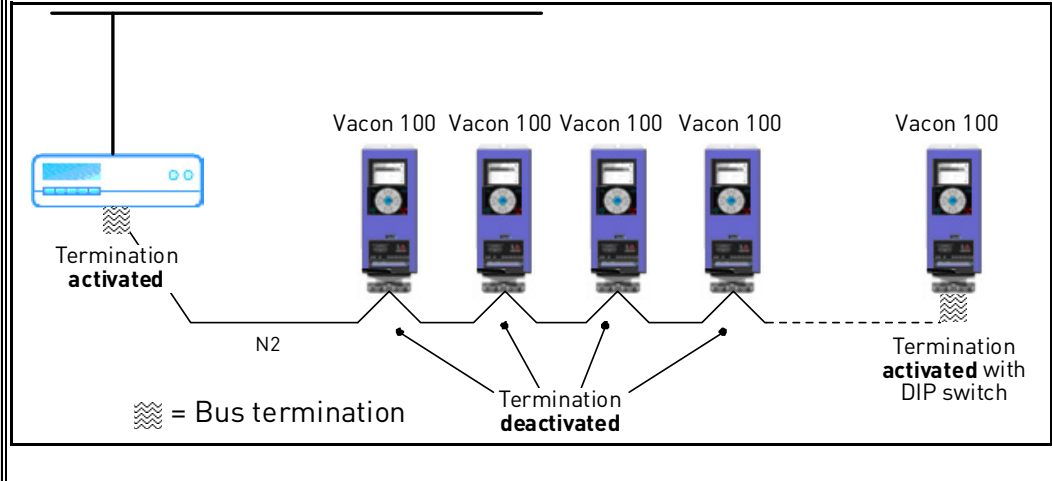

Figure 3.

5 Using the cable clamp included in the delivery of the drive, ground the shield of the RS485 cable to the frame of the AC drive.



<p>6</p>	<p>If Vacon 100 is the last device on the bus, the bus termination must be set. Locate the DIP switches to the right of the control keypad of the drive and turn the switch for the RS485 bus termination resistor to position ON. Biasing is built in the termination resistor. See also step 9 on page 11.</p>  <p style="text-align: center;">* Bus termination resistor</p>
<p>7</p>	<p>Unless already done for the other control cables, cut free the opening on the AC drive cover for the RS485 cable (protection class IP21).</p> 

8	<p>Remount the AC drive cover and run the RS485 cables as shown in picture.</p> <p>NOTE: When planning the cable runs, remember to keep the distance between the fieldbus cable and the motor cable at a minimum of 30 cm.</p>	 <p style="text-align: right;">RS485 cables</p>
9	<p>The bus termination must be set for the first and the last device of the fieldbus line. See picture below. See also step 6 on page 10. We recommend that the first device on the bus and, thus, terminated was the Master device.</p>  <p style="text-align: center;">Vacon 100 Vacon 100 Vacon 100 Vacon 100 Vacon 100</p> <p style="text-align: center;">Termination activated N2 Termination deactivated Termination activated with DIP switch</p> <p style="text-align: center;">⊘ = Bus termination</p>	

5. PROGRAMMING

Basic information on how to use the control keypad you will find in the Vacon HVAC Drive Application Manual.

The navigation path to the fieldbus parameters may differ from application to application. The exemplary paths below apply to the Vacon 100 HVAC drive.

1. First ensure that the right fieldbus protocol is selected.

Navigate: Main Menu > I/O and Hardware (M5) > RS-485 (M5.7) > Common settings (M5.7.1) > Protocol (P5.7.1.1) > Edit > (Choose protocol)

2. Select 'Fieldbus control' as the Remote Control Place.

Navigate: Main Menu > Quick Setup (M1) > Rem. Ctrl. Place (P1.15)

OR

Navigate: Main Menu > Parameters (M3) > Start/Stop Setup (M3.2) > Rem. Ctrl. Place (P3.2.1)

3. Choose source of reference.

Navigate: Main Menu > Parameters (M3) > References (M3.3)

4. Set fieldbus parameters in menu M5.7. See below.

5.1 N2 PARAMETERS AND MONITORING VALUES (M5.7.3)

Code	Parameter	Min	Max	Unit	Default	ID	Description
PARAMETERS							
P5.7.3.1.1	Slave address	1	255		1		Unique slave device address.
P5.7.3.1.2	Communication time-out	0	255	s	10		0 = Not used

Table 4. Parameters related to N2

Code	Parameter	Min	Max	Unit	Default	ID	Description
MONITORING VALUES							
P5.7.3.2.1	Fieldbus protocol status	1	3		1		0 = Init 1 = Stopped 2 = Operational 3 = Faulted
P5.7.3.2.2	Communication status	0.0	99.999		0.0		0-99 Number of messages with errors 0-999 Number of messages without communication errors
P5.7.3.2.3	Invalid data	0					
P5.7.3.2.4	Invalid commands	0					
P5.7.3.2.5	Command not accepted	0					
P5.7.3.2.6	Control word			hex			See page 15.
P5.7.3.2.7	Status word			hex			See page 15.

Table 5. Monitoring values related to N2

5.2 N2 PARAMETER DESCRIPTIONS

5.2.1 N2 PARAMETERS

P5.7.3.1.1 SLAVE ADDRESS

Each slave must have a unique address (from 1 to 255) so that it can be addressed independently from other nodes.

P5.7.3.1.2 COMMUNICATION TIME-OUT

N2 board initiates a communication error for a time defined with this parameter. '0' means that no fault is generated.

5.2.2 N2 MONITORING VALUES

P5.7.3.2.1 FIELDBUS PROTOCOL STATUS

Fieldbus Protocol Status tells the status of the protocol.

INITIALIZING	Protocol is starting up
STOPPED	Protocol is timeouted or not used
OPERATIONAL	Protocol is running
FAULTED	Major fault in protocol, requires restarting. If fault remains contact fieldbus@vacon.com

Table 6. FB protocol statuses

P5.7.3.2.2 COMMUNICATION STATUS

The *Communication status* shows how many error and how many good messages the frequency converter has received. The Communication status includes a common error counter that counts CRC and parity errors and a counter for good messages.

Only messages to the current slave in use are counted in the good messages.

Good messages	
0...999	Number of messages received without errors
Bad Frames	
0...99	Number of messages received with errors

Table 7.

P5.7.3.2.3 INVALID DATA

One of the fields contains a value that is out of the expected range.

P5.7.3.2.4 INVALID COMMANDS

Command not appropriate for this field or record.

P5.7.3.2.5 COMMAND NOT ACCEPTED

Due to problems with the device, the command is ignored.

P5.7.3.2.6 CONTROL WORD

Shows the *Control Word* received from the bus.

P5.7.3.2.7 STATUS WORD

Shows the current *Status Word* that is sent to the bus.

6. COMMUNICATIONS

Features of the N2-Vacon interface:

- Direct control of Vacon drive (e.g. Run, Stop, Direction, Speed reference, Fault reset)
- Full access to all Vacon parameters
- Monitor Vacon status (e.g. Output frequency, Output current, Fault code)

6.1 METASYS N2 INTERFACE

Features of the N2 Interface:

- Direct control of drive (e.g. Run, Stop, Direction, Speed reference, Fault reset)
- Full access to necessary parameters
- Monitor drive status (e.g. Output frequency, Output current, Fault code)
- In standalone operation, or should the polling stop, the overridden values are released after a specified period (about 10 minutes).

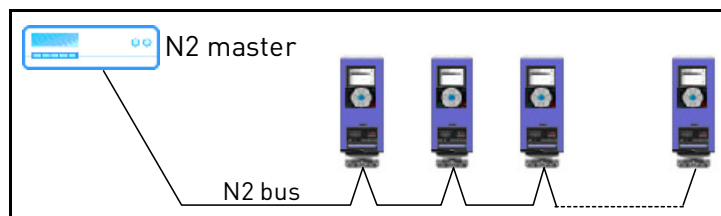

Figure 4. Principal example diagram of Metasys N2

6.1.1 ANALOGUE INPUT (AI)

All Analogue Input (AI) points have the following features:

- Support Change of State (COS) reporting based on high and low warning limits.
- Support Change of State (COS) reporting based on high and low alarm limits.
- Support Change of State (COS) reporting based on override status.
- Always considered reliable and never out of range.
- Writing of alarm and warning limit values beyond the range that can be held by the drive's internal variable will result in having that limit replaced by the "Invalid Float" value even though the message is acknowledged. The net result will be the inactivation of the alarm or warning (the same as if the original out of range value was used).
- Overriding is supported from the standpoint that the "Override Active" bit will be set and the value reported to the N2 network will be the overridden value. However, the value in the drive remains unchanged. Therefore, the N2 system should be set up to disallow overriding AI points or have an alarm condition activated when an AI point is overridden.
- Overriding an AI point with a value beyond the limit allowed by the drive's internal variable will result in an "Invalid Data" error response and the override status and value will remain unchanged.

6.1.2 BINARY INPUT (BI)

All Binary Input (BI) points have the following features:

- Support Change of State (COS) reporting based on current state.
- Support Change of State (COS) reporting based on alarm condition.
- Support Change of State (COS) reporting based on override status.
- Always considered reliable.

Overriding is supported from the standpoint that the "Override Active" bit will be set and the value reported to the N2 network will be the overridden value. However, the value in the drive remains unchanged. Therefore, the N2 system should be set up to disallow overriding BI points or have an alarm condition activated when a BI point is overridden.

6.1.3 ANALOGUE OUTPUT (AO)

All Analogue Output (AO) points have the following features:

- Support Change of State (COS) reporting based on override status.
- Always considered reliable.
- Overriding of the AO points is the method used to change a value. Overriding an AO point with a value beyond the limit allowed by the drive's internal variable will result in an "Invalid Data" error response and the override status and value will remain unchanged. If the overridden value is beyond the drive's parameter limit but within the range that will fit in the variable, an acknowledge response is given and the value will be internally clamped to its limit.
- An AO point override copies the override value to the corresponding drive parameter. This is the same as changing the value on the keypad. The value is non-volatile and will remain in effect when the drive is turned off and back on. It also remains at this value when the N2 network "releases" the point. The N2 system always reads the current parameter value.

NOTE:

On some N2 systems, the system will not poll the AO point when it is being overridden. In this case, the N2 system will not notice a change in value if the change is made with the keypad. To avoid this, set the point up as a "local control" type and release it once it has been overridden. In this way, the N2 system will monitor the value when not being overridden.

6.1.4 BINARY OUTPUT (BO)

All Binary Output (BO) points have the following features:

- Support Change of State (COS) reporting based on override status.
- Always considered reliable.
- Overriding BO points control the drive. These points are input commands to the drive. When released, the drive's internal value remains at its last overridden value.

6.1.5 INTERNAL INTEGER (ADI)

All Internal Integer (ADI) points have the following features:

- Do not support Change of State (COS) reporting.
- Can be overridden and the "Override Active" bit will be set. However, the Internal value is unchanged (Read Only).

6.2 N2 POINT MAP

6.2.1 ANALOGUE INPUTS (AI)

NPT	NPA	Description	Units	Note
AI	1	Speed Setpoint	Hz	2 decimals
AI	2	Output Frequency	Hz	2 decimals
AI	3	Motor Speed	Rpm	0 decimals
AI	4	Load (power)	%	1 decimal
AI	5	Megawatt Hours	MWh	Total Counter
AI	6	Motor Current	A	2 decimals
AI	7	Bus Voltage	V	0 decimals
AI	8	Motor Volts	V	1 decimal
AI	9	Heatsink Temperature	° C	0 decimals
AI	10	Motor Torque	%	1 decimal
AI	11	Operating Days (trip)	Day	0 decimals
AI	12	Operating Hours (trip)	Hour	0 decimals
AI	13	Kilowatt Hours (trip)	kWh	Trip Counter
AI	14	Torque Reference	%	1 decimal
AI	15	Motor Temperature Rise	%	1 decimal
AI	16	FBProcessDataOut1 ¹⁾	-32768 to +32767	0 decimals
AI	17	FBProcessDataOut2 ¹⁾	-32768 to +32767	0 decimals
AI	18	FBProcessDataOut3 ¹⁾	-32768 to +32767	0 decimals
AI	19	FBProcessDataOut4 ¹⁾	-32768 to +32767	0 decimals
AI	20	FBProcessDataOut5 ¹⁾	-32768 to +32767	0 decimals
AI	21	FBProcessDataOut6 ¹⁾	-32768 to +32767	0 decimals
AI	22	FBProcessDataOut7 ¹⁾	-32768 to +32767	0 decimals
AI	23	FBProcessDataOut8 ¹⁾	-32768 to +32767	0 decimals

¹⁾ These analogue inputs are application specific.

Table 8.

6.2.2 BINARY INPUTS (BI)

NPT	NPA	Description	0 =	1 =
BI	1	Ready	Not Ready	Ready
BI	2	Run	Stop	Run
BI	3	Direction	Clockwise	Counterclockwise
BI	4	Faulted	Not Faulted	Faulted
BI	5	Alarm	Not Alarm	Alarm
BI	6	Ref. Frequency reached	False	True
BI	7	Motor running zero speed	False	True
BI	8	Flux ready	Not ready	Ready

Table 9.

6.2.3 ANALOGUE OUTPUTS (AO)

NPT	NPA	Description	Units	Note
AO	1	Comms Speed	%	2 decimals
AO	2	Current Limit	A	2 decimals
AO	3	Minimum Speed	Hz	2 decimals
AO	4	Maximum Speed	Hz	2 decimals
AO	5	Accel Time	s	1 decimal
AO	6	Decel Time	s	1 decimal
AO	7	FBProcessDataIN 1 ¹⁾	-32768 to +32767	2 decimals
AO	8	FBProcessDataIN 2 ¹⁾	-32768 to +32767	2 decimals
AO	9	FBProcessDataIN 3 ¹⁾	-32768 to +32767	2 decimals
AO	10	FBProcessDataIN 4 ¹⁾	-32768 to +32767	2 decimals
AO	11	FBProcessDataIN 5 ¹⁾	-32768 to +32767	2 decimals
AO	12	FBProcessDataIN 6 ¹⁾	-32768 to +32767	2 decimals
AO	13	FBProcessDataIN 7 ¹⁾	-32768 to +32767	2 decimals
AO	14	FBProcessDataIN 8 ¹⁾	-32768 to +32767	2 decimals
AO	15	Any parameter Read/Write	-	Depends on parameter

¹⁾ These Analogue Outputs are application specific.

Table 10.

6.2.4 BINARY OUTPUTS (BO)

NPT	NPA	Description	0 =	1 =
BO	1	Comms Start/Stop	Stop	Start
BO	2	Comms Forward/Reverse	Forward	Reverse
BO	3	Reset Fault	N/A	Reset
BO	4	Stop mode information 1	-	-
BO	5	Stop mode information 2	-	-
BO	6	Force ramp to zero	-	-
BO	7	Freeze ramp	-	-
BO	8	Reference to zero	-	-
BO	9	BusCtrl	-	-
BO	10	BusRef	-	-

Table 11.

6.2.5 INTERNAL INTEGERS (ADI)

NPT	NPA	Description	Units
ADI	1	Active Fault Code	-
ADI	2	Control Word	-
ADI	3	Status Word	-
ADI	4	Any parameter ID	-

Table 12.

7. FAULT TRACING

When an unusual operating condition is detected by the AC drive control diagnostics, the drive initiates a notification visible, for example, on the keypad. The keypad will show the ordinal number of the fault, the fault code and a short fault description.

The fault can be reset with the Reset button on the control keypad or via the I/O terminal. The faults are stored in the Fault history menu which can be browsed. The different fault codes you will find in the table below. This fault table presents only the faults related to the fieldbus in use.

NOTE: When contacting distributor or factory because of a fault condition, always write down all texts and codes on the keypad display and send a description of the problem together with the *Drive Info File* to fieldbus@vacon.com.

7.1 TYPICAL FAULT CONDITIONS

Fault condition	Possible cause	Remedy
Termination resistor	Missing or excessive termination resistor.	Install termination resistors at both ends of the fieldbus line.
Cabling	<ul style="list-style-type: none"> Supply or motor cables are located too close to the fieldbus cable Wrong type of fieldbus cable Too long cabling 	
Grounding	Inadequate grounding.	Ensure grounding in all points on the net
Connections	Faulty connections. <ul style="list-style-type: none"> Excessive stripping of cables Conductors in wrong terminals Too loose connections of conductors 	
Parameter	<ul style="list-style-type: none"> Faulty address Overlapping slave addresses Wrong baud rate Wrong control place selected 	

Table 13. Typical fault conditions

7.2 RS-485 BUS BIASING

When none of the devices on the RS-485 bus is sending data all devices are in idle status. This being the case, the bus voltage is in indefinite state, usually near 0 V due to the termination resistors. This may cause problems in character reception because the single characters in serial communication begin with start bit referring to bus status '0' with voltage of less than -200mV whereas the bus status '1' corresponds to bus voltage of more than +200mV. The RS-485 standard considers the voltage interval -200mV...+200mV as undefined state. Bus biasing is therefore needed to maintain the voltage in status '1' (above +200mV) also between the messages.

To bias the bus you will have to add a separate active termination resistor specifically designed for the RS-485 bus (e.g. Siemens active RS 485 terminating element (6ES7972-0DA00-0AA0)).

7.3 OTHER FAULT CONDITIONS

The following fault tracing diagram will help you to locate and fix some of the most usual problems. If the problem persists contact your local distributor.

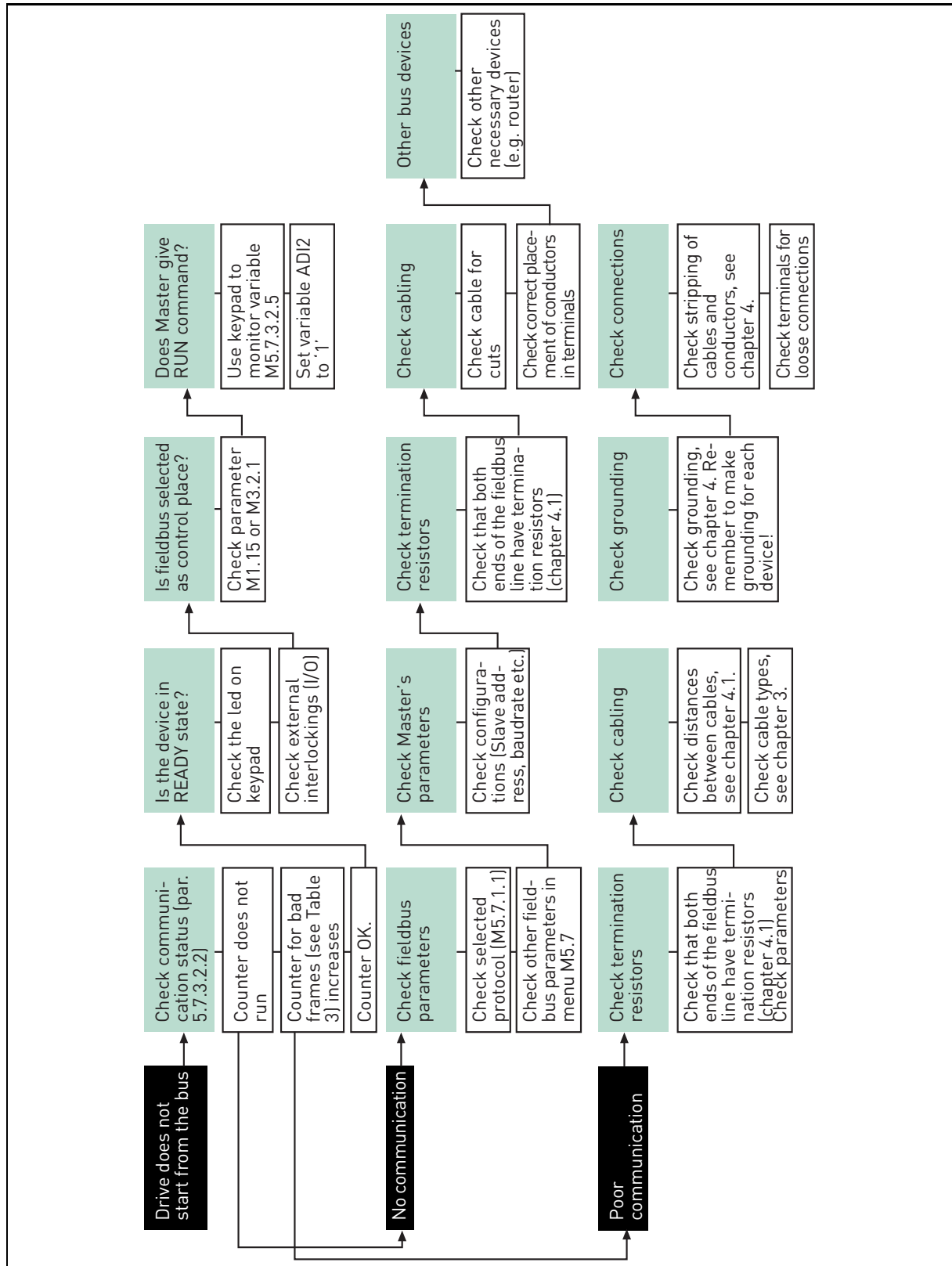

Figure 5. Fault tracing diagram for N2

8. QUICK SETUP

Following these instructions, you can easily and fast set up your N2 bus for use:

1	<p>Choose control place.</p> <ul style="list-style-type: none">A. Press LOC/REM button on keypad to select <i>Remote Control Place</i>B. Select <i>Fieldbus</i> as remote control place: <i>Main Menu > Quick Setup (M1) > Rem. Ctrl. Place (P1.15) > FieldbusCTRL</i>
2	<p>Make these settings in the master software</p> <ul style="list-style-type: none">C. Set <i>Control Word</i> to '0' (ADI2)D. Set <i>Control Word</i> to '1' (ADI2)E. Frequency converter status is RUNF. Set Reference value to '50.00%' (A01).G. <i>Output Frequency</i> (AI2) is 25.00Hz if MinFreq is 0.00 Hz and MaxFreq is 50.00 HzH. Set <i>Control Word</i> to '0' (ADI2)I. Frequency converter status is STOP.

9. ANNEX

Process Data IN (Master to Slave)

Use of Process Data In variables depends on the used application. The configuration of the data is free.

Process Data OUT (Slave to Master)

Use of Process Data Out variables depends on the used application.

The Fieldbus Master can read the frequency converter's actual values using process data variables. Control applications use process data as follows:

ID	Data	Value	Unit	Scale
2104	Process data OUT 1	Output Frequency	Hz	0,01 Hz
2105	Process data OUT 2	Motor Speed	rpm	1 rpm
2106	Process data OUT 3	Motor Current	A	0,1 A
2107	Process data OUT 4	Motor Torque	%	0,1 %
2108	Process data OUT 5	Motor Power	%	0,1 %
2109	Process data OUT 6	Motor Voltage	V	0,1 V
2110	Process data OUT 7	DC link voltage	V	1 V
2111	Process data OUT 8	Active Fault Code	-	-

Table 14. Process Data OUT variables

VACON

DRIVEN BY DRIVES

Find your nearest Vacon office
on the Internet at:

www.vacon.com

