

WIRE COLOR SCHEME	
BLACK	- LINE VOLTAGE
RED	- AC CONTROL
WHITE	- AC GROUNDED
	- CIRCUIT CONDUCTOR
BLUE	- DC CONTROL
WHT/BLU	- DC CONTROL COMMON
GREEN	- CHASSIS GROUND

* ALL CONTROL WIRES ARE BLUE EXCEPT WHERE NOTED.

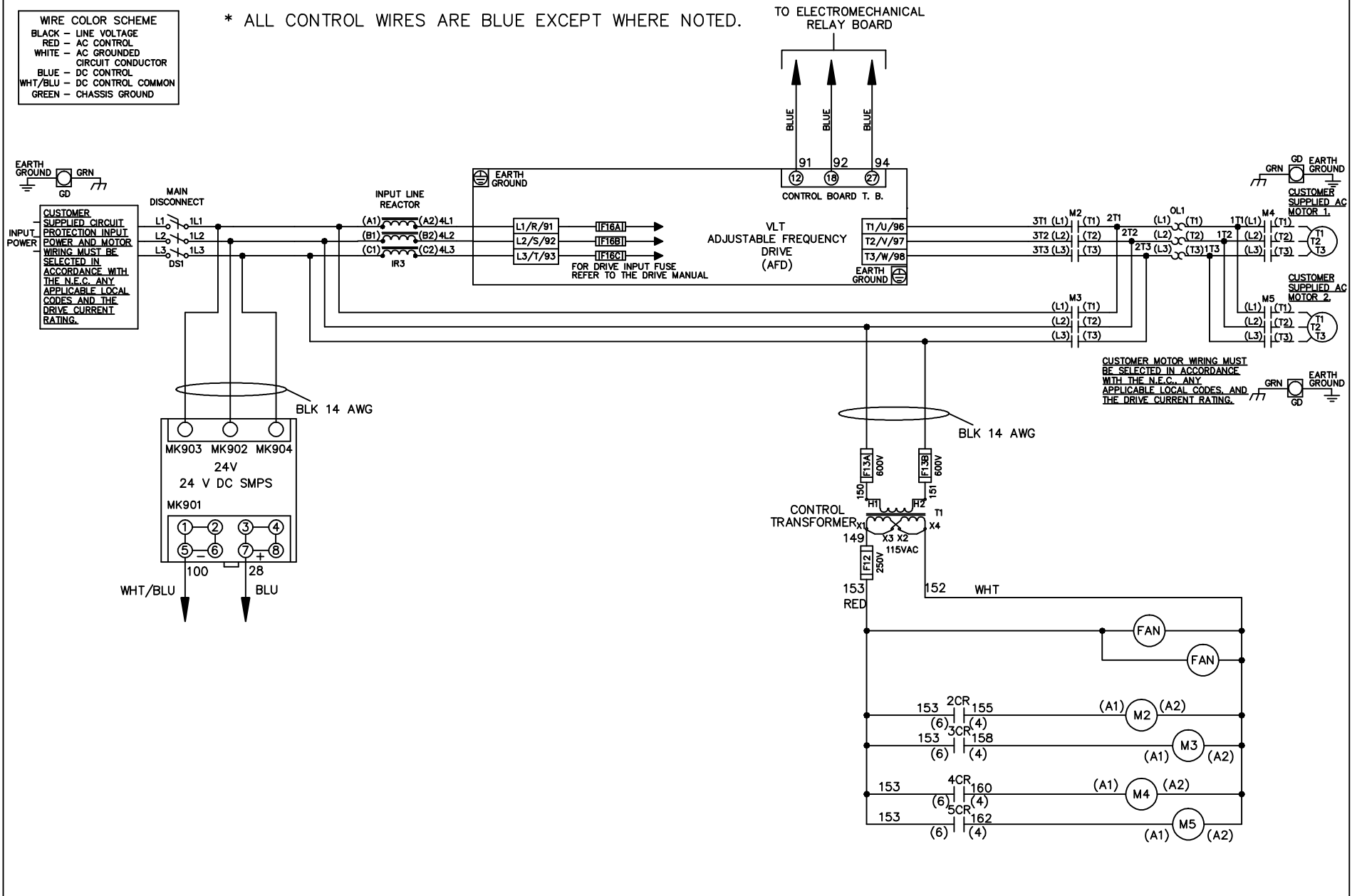

			- NOTICE -		DRN JNW 2/14/07		NAME600 VOLT,2C,MAIN DISC ,DRIVE FUSE,EMB1,FRAME D1-D2 ,REACTOR,CMS		<i>Danfoss</i>	
A	SP08061	10/08	THIS DOCUMENT CONTAINS PROPRIETARY INFORMATION OF DANFOSS DRIVES. IT IS LOANED BY DANFOSS DRIVES SUBJECT TO THE CONDITIONS THAT IT AND THE INFORMATION EMBODIED THEREIN SHALL BE USED ONLY FOR RECORD AND REFERENCE PURPOSES. SHALL NOT BE USED OR CAUSED TO BE USED IN ANY WAY PREJUDICIAL TO THE INTERESTS OF DANFOSS DRIVES, SHALL NOT BE REPRODUCED OR COPIED IN WHOLE OR IN PART, OR DISCLOSED TO ANYONE WITHOUT THE DIRECT WRITTEN PERMISSION OF DANFOSS DRIVES AND SHALL BE RETURNED UPON REQUEST.			APR	MODEL	PAGE 1 OF 2	SIZE A	DWG NO. 174U3210
REV	ECN	DATE								

REV	ECN	DATE
A	SP08066	10/08

NOTICE
 THIS DOCUMENT CONTAINS PROPRIETARY INFORMATION OF DANFOSS DRIVES. IT IS LOANED BY DANFOSS DRIVES SUBJECT TO THE CONDITIONS THAT IT AND THE INFORMATION EMBODIED THEREIN SHALL BE USED ONLY FOR RECORD AND REFERENCE PURPOSES. SHALL NOT BE USED OR CAUSED TO BE USED IN ANY WAY PREJUDICIAL TO THE INTERESTS OF DANFOSS DRIVES. SHALL NOT BE REPRODUCED OR COPIED IN WHOLE OR IN PART, OR DISCLOSED TO ANYONE WITHOUT THE DIRECT WRITTEN PERMISSION OF DANFOSS DRIVES AND SHALL BE RETURNED UPON REQUEST.

DRN JNW
 2/14/07
 APR

NAME 600 VOLT, 2C, MAIN DISC
 DRIVE FUSE, EMB1, FRAME D1-D2
 REACTOR, CMS

MODEL
 PAGE 2 OF 2
 SIZE A
 DWG NO. 174U3210

CONTACT SEQUENCE CHART FOR S1
 X INDICATES CONTACT CLOSED

POSITION	CONTACT	DRIVE	OFF	BYPASS
13-14				X
23-24		X		

CONTACT SEQUENCE CHART FOR S2
 X INDICATES CONTACT CLOSED

POSITION	CONTACT	MOTOR 1	AUTO	MOTOR 2
11-12		X	X	
13-14				X
21-22			X	X
23-24		X		



FACTORY SETTING



CUSTOMER CONNECTIONS X55, X56
 CLASS 2 POWER SOURCE
 REQUIRED FOR FIELD CONNECTION
 USE CLASS 1 CONDUCTORS
 CONDUCTOR SIZE 28-14 AWG

