

WIRE COLOR SCHEME
 BLACK - LINE VOLTAGE
 RED - AC CONTROL
 WHITE - AC GROUNDED
 WHITE - CIRCUIT CONDUCTOR
 BLUE - DC CONTROL
 WHT/BLU - DC CONTROL COMMON
 GREEN - CHASSIS GROUND

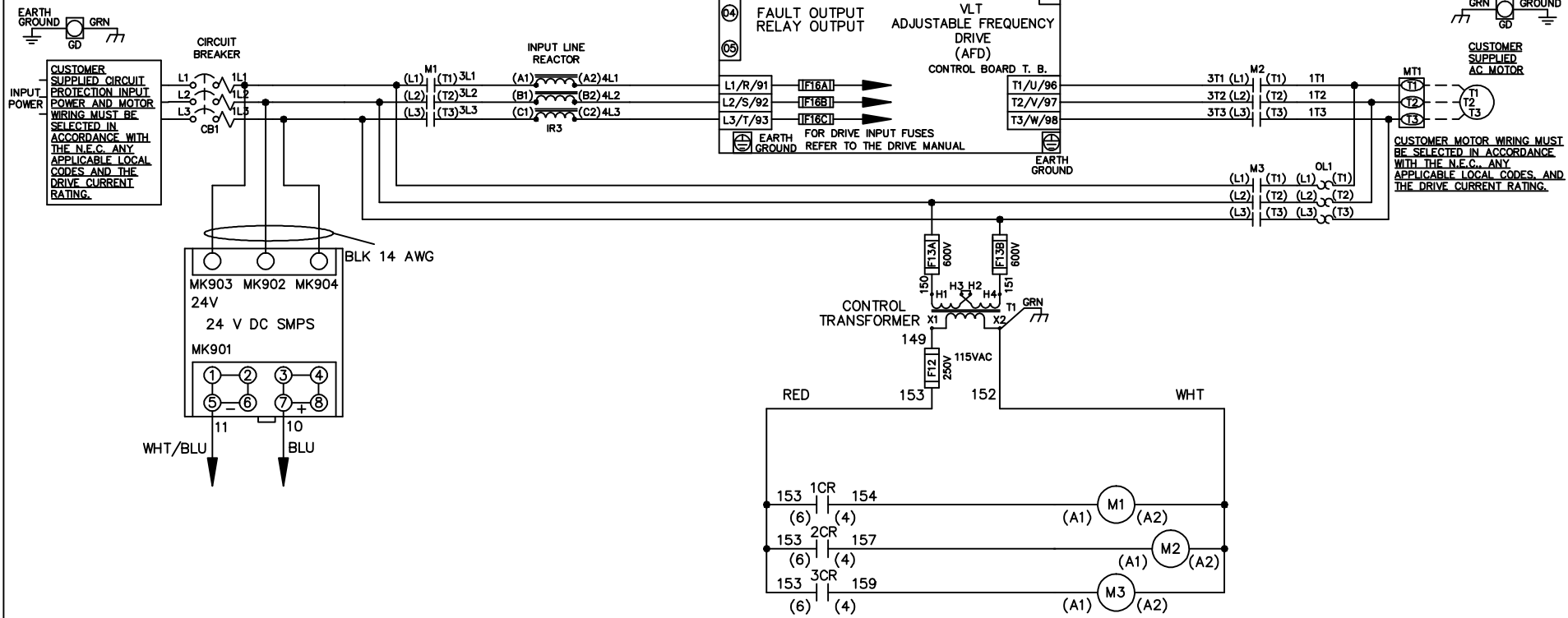

			- NOTICE -		DRN JNW 2/14/07		NAME 460 VOLT,3C,CB ,DRIVE FUSE,ECB,FRAME C2N1_ ,REACTOR,SINGLE MTR		<i>Danfoss</i>	
A	SP08061	10/08	THIS DOCUMENT CONTAINS PROPRIETARY INFORMATION OF DANFOSS DRIVES. IT IS LOANED BY DANFOSS DRIVES SUBJECT TO THE CONDITIONS THAT IT AND THE INFORMATION EMBODIED THEREIN SHALL BE USED ONLY FOR RECORD AND REFERENCE PURPOSES, SHALL NOT BE USED OR CAUSED TO BE USED IN ANY WAY PREJUDICIAL TO THE INTERESTS OF DANFOSS DRIVES, SHALL NOT BE REPRODUCED OR COPIED IN WHOLE OR IN PART, OR DISCLOSED TO ANYONE WITHOUT THE DIRECT WRITTEN PERMISSION OF DANFOSS DRIVES AND SHALL BE RETURNED UPON REQUEST.			APR	MODEL	PAGE 1 OF 2	SIZE A	DWG NO. 174U3774
REV	ECN	DATE								

REV	A	SP08066	10/08
ECN			
DATE			

NOTICE
 THIS DOCUMENT CONTAINS PROPRIETARY INFORMATION OF DANFOSS DRIVES. IT IS LOANED BY DANFOSS DRIVES SUBJECT TO THE CONDITIONS THAT IT AND THE INFORMATION EMBODIED THEREIN SHALL BE USED ONLY FOR RECORD AND REFERENCE PURPOSES. SHALL NOT BE USED OR CAUSED TO BE USED IN ANY WAY PREJUDICIAL TO THE INTERESTS OF DANFOSS DRIVES. SHALL NOT BE REPRODUCED OR COPIED IN WHOLE OR IN PART, OR DISCLOSED TO ANYONE WITHOUT THE DIRECT WRITTEN PERMISSION OF DANFOSS DRIVES AND SHALL BE RETURNED UPON REQUEST.

DRN JNW
 2/14/07
 APR

NAME460 VOLT,3C,CB
 ,DRIVE FUSE,ECB,FRAME C2N1
 ,REACTOR,SINGLE MTR

MODEL

PAGE 2 OF 2

SIZE A

DWG NO. 174U3774



CUSTOMER CONNECTIONS X56,X57,X59
 CLASS 2 POWER SOURCE
 REQUIRED FOR FIELD CONNECTION
 USE CLASS 1 CONDUCTORS
 CONDUCTOR SIZE 28-14 AWG

