

* ALL CONTROL WIRES ARE BLUE EXCEPT WHERE NOTED.

WIRE COLOR SCHEME	
BLACK	- LINE VOLTAGE
RED	- AC CONTROL
WHITE	- AC GROUNDED CIRCUIT CONDUCTOR
BLUE	- DC CONTROL
WHT/BLU	- DC CONTROL COMMON
GREEN	- CHASSIS GROUND

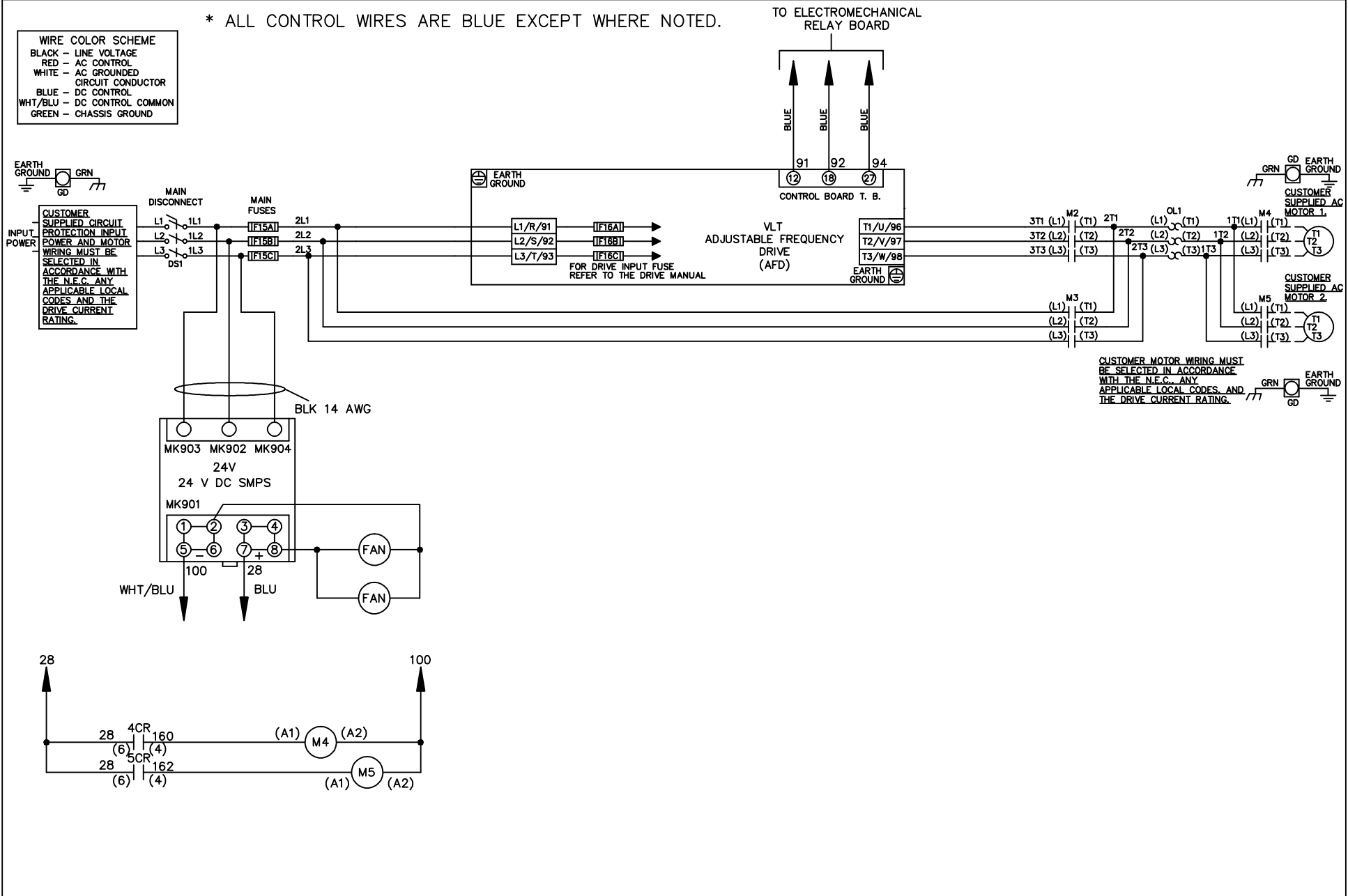

CUSTOMER MOTOR WIRING MUST BE SELECTED IN ACCORDANCE WITH THE N.E.C. ANY APPLICABLE LOCAL CODES AND THE DRIVE CURRENT RATING.

			-NOTICE-		DRN JNW 2/14/07		NAME 208-600VOLT, 2C, MAIN DISC , MAIN FUSE, EMB1, FRAME C1N12 , NO REACTOR & DVDT, CMS		THE TRANE COMPANY A DIVISION OF AMERICAN STANDARD INC.		
A	SP08061	10/08	THIS DRAWING IS PROPRIETARY AND SHALL NOT BE COPIED OR ITS CONTENTS DISCLOSED TO OUTSIDE PARTIES WITHOUT THE WRITTEN CONSENT OF THE TRANE COMPANY			APR	MODEL	PAGE 1 OF 2	SIZE A	DWG NO.	174U5337
REV	ECN	DATE									

REV	ECN	DATE
A	SP08066	10/08

THIS DRAWING IS PROPRIETARY AND SHALL NOT BE COPIED OR ITS CONTENTS DISCLOSED TO OUTSIDE PARTIES WITHOUT THE WRITTEN CONSENT OF THE TRANE COMPANY

DRN JNW
2/14/07
APR

NAME 208-600VOLT, 2C, MAIN DISC
, MAIN FUSE, EMB1, FRAME C1N12
, NO REACTOR & DVDT, CMS

MODEL
PAGE 2 OF 2
SIZE A

DWG NO. 174U5337
THE TRANE COMPANY
A DIVISION OF
AMERICAN STANDARD INC.

CONTACT SEQUENCE CHART FOR S1
X INDICATES CONTACT CLOSED

POSITION	DRIVE	OFF	BYPASS
13-14			X
23-24	X		

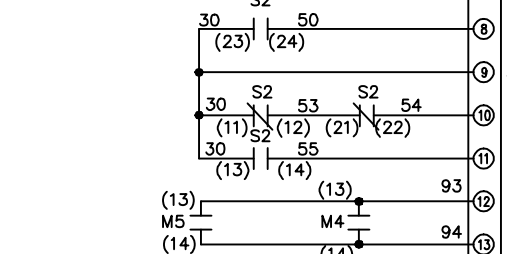
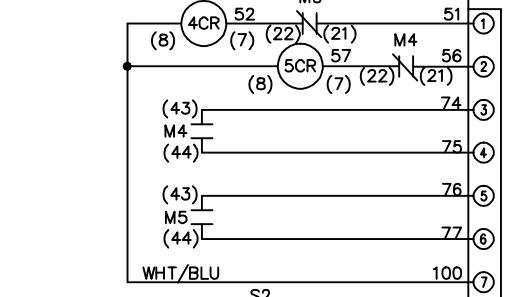
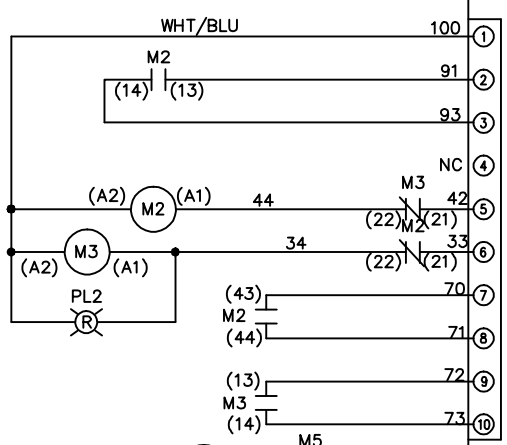
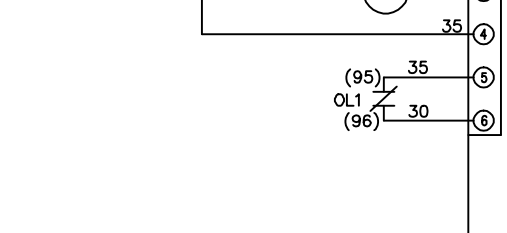

CONTACT SEQUENCE CHART FOR S2
X INDICATES CONTACT CLOSED

POSITION	MOTOR 1	AUTO	MOTOR 2
11-12		X	
13-14			X
21-22			X
23-24	X		

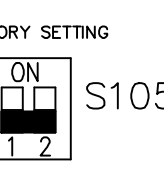
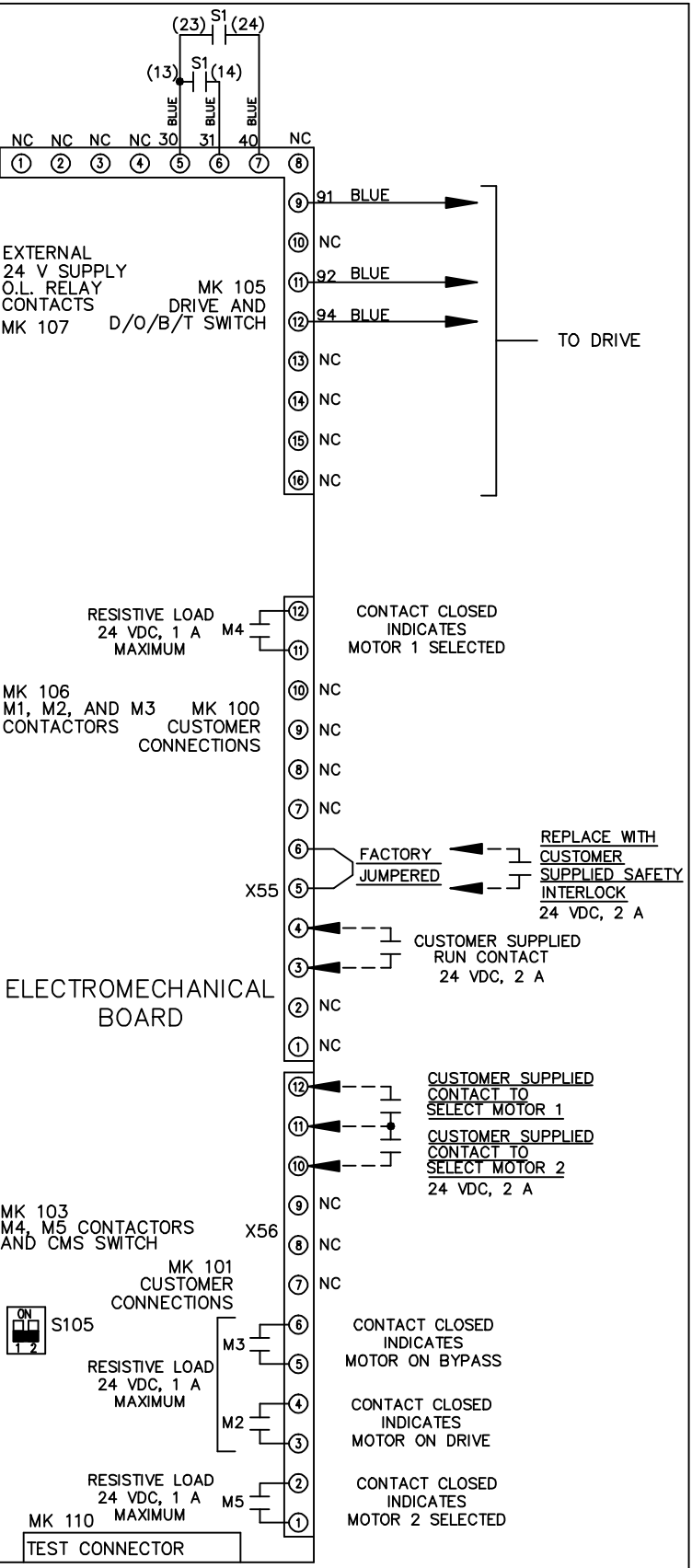

CUSTOMER CONNECTIONS X55, X56
CLASS 2 POWER SOURCE
REQUIRED FOR FIELD CONNECTION
USE CLASS 1 CONDUCTORS
CONDUCTOR SIZE 28-14 AWG