

WIRE COLOR SCHEME
 BLACK - LINE VOLTAGE
 RED - AC CONTROL
 WHITE - AC GROUNDED
 BLUE - CIRCUIT CONDUCTOR
 BLUE - DC CONTROL
 WHT/BLU - DC CONTROL COMMON
 GREEN - CHASSIS GROUND

* ALL CONTROL WIRES ARE BLUE EXCEPT WHERE NOTED. TO ELECTROMECHANICAL RELAY BOARD

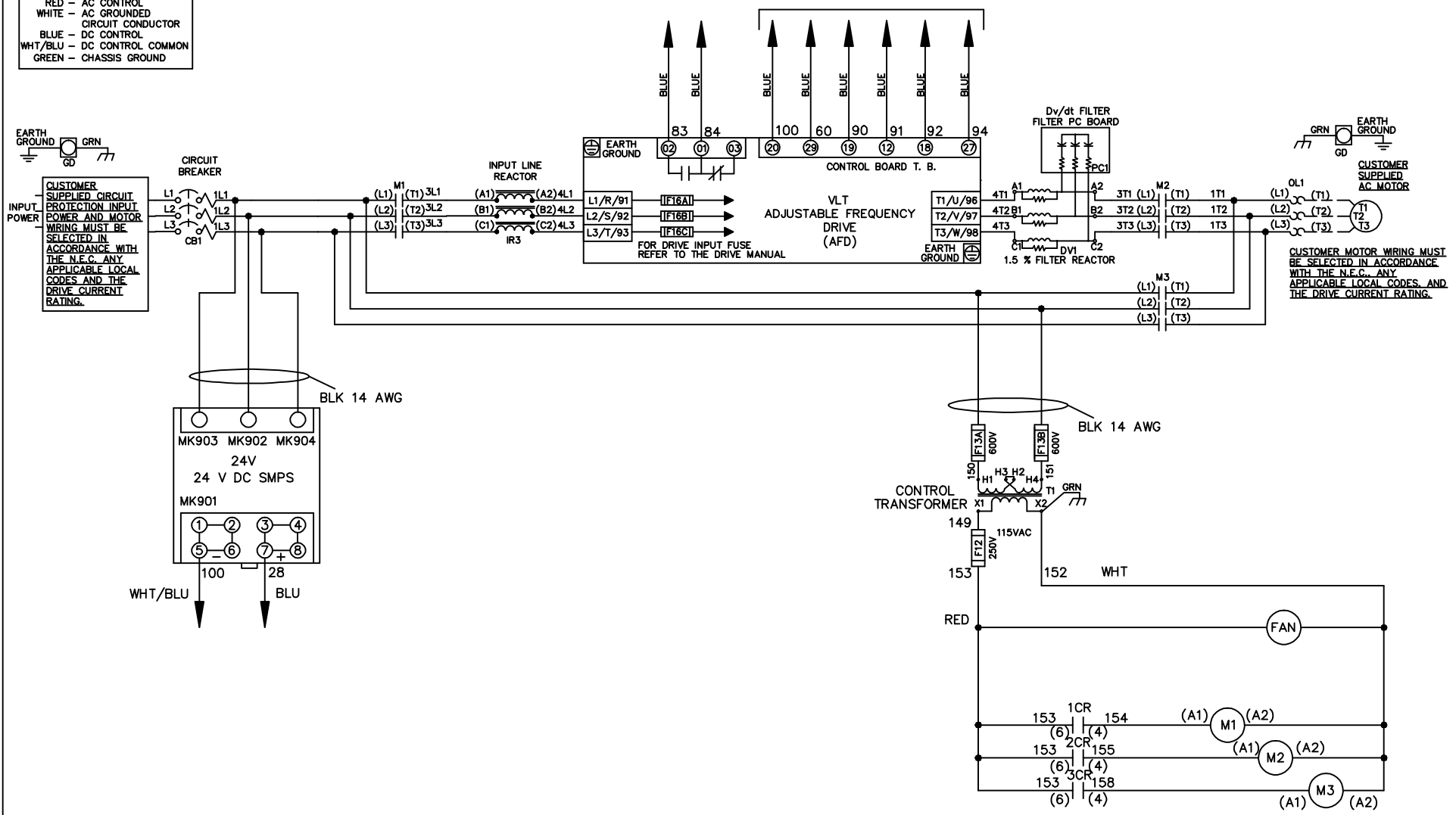

			-NOTICE-		DRN JNW 2/14/07		NAME 460 VOLT, 3C, CB , DRIVE FUSE, EMB2, FRAME D1-D2 , REACTOR & DVDT, SINGLE MTR		THE TRANE COMPANY A DIVISION OF AMERICAN STANDARD INC.	
A	SP08061	10/08	THIS DRAWING IS PROPRIETARY AND SHALL NOT BE COPIED OR ITS CONTENTS DISCLOSED TO OUTSIDE PARTIES WITHOUT THE WRITTEN CONSENT OF THE TRANE COMPANY			APR	MODEL	PAGE 1 OF 2	SIZE A	DWG NO. 174U8763
REV	ECN	DATE								

REV	ECN	DATE
A	SP08066	10/08

CONTACT	POSITION	DRIVE	OFF	BYPASS	TEST
1-2		X			X
3-4				X	X
5-6		X			
7-8					X

CONTACT SEQUENCE CHART FOR S1
X INDICATES CONTACT CLOSED

-NOTICE-
 THIS DRAWING IS PROPRIETARY AND SHALL NOT BE COPIED OR ITS CONTENTS DISCLOSED TO OUTSIDE PARTIES WITHOUT THE WRITTEN CONSENT OF THE TRANE COMPANY

DRN JNW
2/14/07
APR

NAME 460 VOLT, 3C, CB
DRIVE FUSE, EMB2, FRAME D1-D2
REACTOR & DVDI, SINGLE MTR

THE TRANE COMPANY
A DIVISION OF
AMERICAN STANDARD INC.



CUSTOMER CONNECTIONS X55, X56, X58
CLASS 2 POWER SOURCE
REQUIRED FOR FIELD CONNECTION
USE CLASS 1 CONDUCTORS
CONDUCTOR SIZE 28-14 AWG

ELECTROMECHANICAL BOARD

