

additional informations:

Inductance : 0,32mH
 Rated current : 25,0A
 Rated voltage : 3x 500V
 Ambient temperature : max. 45°C

label:



earth screw M5x10
 (with lockwasher and washer)

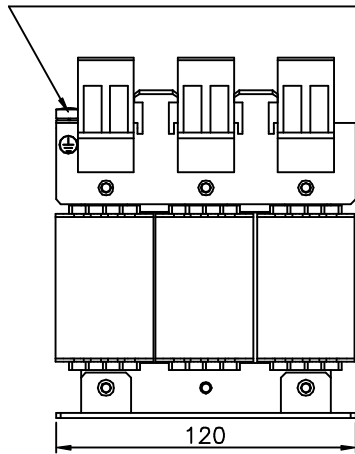

16mm² terminal

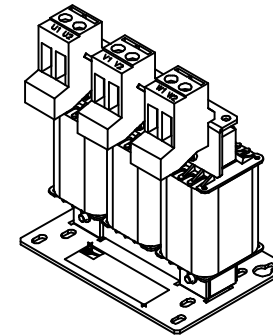
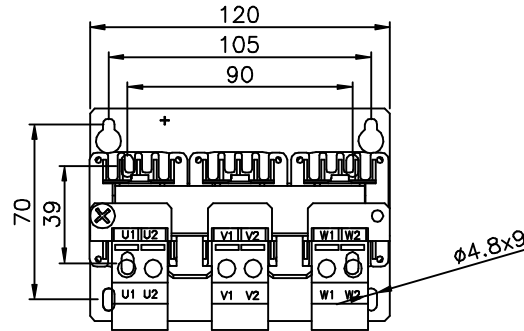
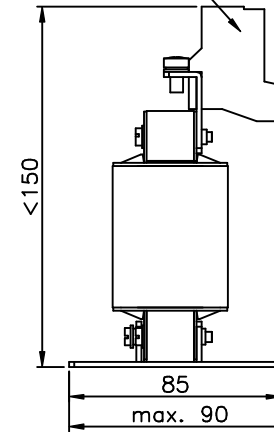

c	23.06.14	Schr./Fle.	Terminalmarking corrected
b	29.01.14	Fle./ Kor.	order number changed
a	14.02.13	Schr./ Kor.	label updated, Terminalmarking included
	date	name	amendment

Dimensions toleranced according to ISO 2768-m

Tolerance class	0,5 to 3	from 3 to 6	from 6 to 30	from 30 to 120	from 120 to 400	from 400 to 1000
m (middle)	±0.1	±0.1	±0.2	±0.3	±0.5	±0.8

drawn	18.10.12	Kornau	Kornau	scale 1:3
checked	18.10.12	Lauer	Lauer	format A4
	date	name	signature	
				DIN ISO 5456
				all dimensions mm

Dimensions B 1101139
 Line Reactor LR3/x 25,0A – IP00

order number	drawing number	modi.	sheet
175U0308	Z791210010	c	1/1

Please observe protection clause to ISO 16016