

WARNING!
 THE FOLLOWING TABLE LISTS THE PARAMETERS THAT ARE SET DIFFERENT FROM THE DRIVE DEFAULT SETTINGS. ADDITIONAL PARAMETER SETTINGS MAY BE REQUIRED FOR YOUR APPLICATION.

DRIVE PARAMETER SETTINGS

PARAMETER #	NAME	SETTING	VALUE
0-02	MOTOR SPEED UNIT	1	HZ
0-03	REGIONAL SETTINGS	1	NORTH AMERICA
1-03	TORQUE CHAR.	3	AUTO ENERGY OPTIM VT
5-02	TERMINAL 29 TYPE	1	OUTPUT
5-31	TERMINAL 29	5	RUNNING
14-20	RESET MODE	13	INFINITE AUTO REST

NOTES:

- * INDICATES COMPONENTS NOT SUPPLIED BY MANUFACTURER.
- REFER TO THE INSTALLATION AND OPERATION MANUAL FOR DRIVE FUNCTIONS AND PARAMETER SETTINGS.
- FEEDER CIRCUIT PROTECTION, INPUT POWER AND MOTOR WIRING MUST BE SELECTED IN ACCORDANCE WITH THE N.E.C., ANY APPLICATION LOCAL CODES AND THE LOAD CURRENT RATING.
- REPLACE JUMPER 'J1' WITH NORMALLY CLOSED SAFETY INTERLOCK CONTACT AS NECESSARY. CONTACT MUST BE RATED 1/4 HP @ 120VAC MINIMUM.
- PANEL MAY REQUIRE DERATING, CONSULT DRIVE MANUAL OR FACTORY FOR FOLLOWING CONDITIONS:
 - HIGHER SWITCHING FREQUENCY THAN DRIVE DEFAULT
 - HIGHER THAN PANEL LISTED AMBIENT TEMPERATURES
 - ELEVATION ABOVE 3300 FEET (1000 METERS)
 - LONG MOTOR LEAD LENGTHS

B			- NOTICE -		DRN	NAME			
A	SP10119	11/10	THIS DOCUMENT CONTAINS PROPRIETARY INFORMATION OF DANFOSS DRIVES. IT IS LOANED BY DANFOSS DRIVES SUBJECT TO THE CONDITIONS THAT IT AND THE INFORMATION EMBODIED THEREIN SHALL BE USED ONLY FOR RECORD AND REFERENCE PURPOSES, SHALL NOT BE USED OR CAUSED TO BE USED IN ANY WAY PREJUDICIAL TO THE INTERESTS OF DANFOSS DRIVES, SHALL NOT BE REPRODUCED OR COPIED IN WHOLE OR IN PART, OR DISCLOSED TO ANYONE WITHOUT THE DIRECT WRITTEN PERMISSION OF DANFOSS DRIVES AND SHALL BE RETURNED UPON REQUEST.		DTM	NEMA 3R,208V,2C , MAIN DISC, MAIN & DRIVE FUSE ,3MB1,CONTACT MOTOR SELECT,1 FAN			
DR	SP10076	09/10			APR	DTM	MODEL	VLT	PAGE 1 OF 2
REV	ECN	DATE							

WIRE COLOR SCHEME
 BLACK - LINE VOLTAGE
 RED - AC CONTROL
 WHITE - AC GROUNDED
 CIRCUIT CONDUCTOR
 BLUE - DC CONTROL
 GREEN - CHASSIS GROUND

TERMINAL IDENTIFICATION

(X) - DRIVE TERMINAL
 (X) - CUSTOMER TERMINAL

CUSTOMER DRY CONTACT RATINGS

RELAY	CONTACT RATING
CR1, CR6	5A @ 120VAC 1/10 HP @ 120VAC
M2, M3, M4, M5	10A @ 120/240VAC

CONTACT SEQUENCE CHART FOR S1
 X INDICATES CONTACT CLOSED

CONTACT \ POSITION	DRIVE	OFF	BYPASS
13-14			X
23-24	X		

CONTACT SEQUENCE CHART FOR S2
 X INDICATES CONTACT CLOSED

CONTACT \ POSITION	MOTOR 1	AUTO	MOTOR 2
11-12	X	X	
13-14			X
21-22		X	X
23-24	X		

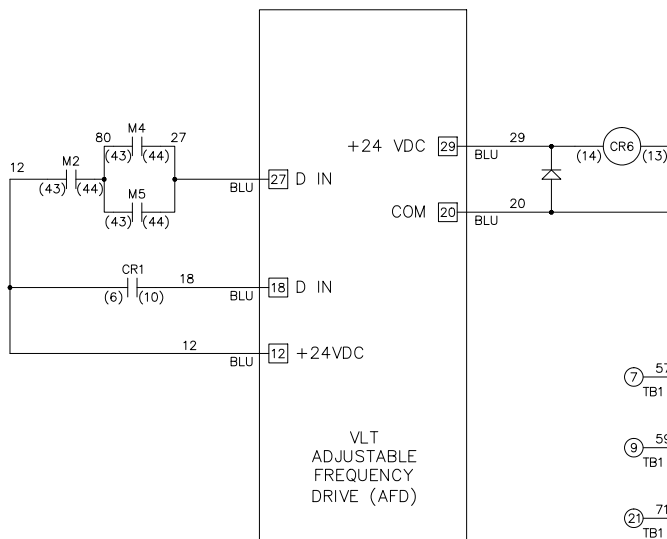

B		
A	SP10119	11/10
DR	SP10076	09/10
REV	ECN	DATE

THIS DOCUMENT CONTAINS PROPRIETARY INFORMATION OF DANFOSS DRIVES. IT IS LOANED BY DANFOSS DRIVES SUBJECT TO THE CONDITIONS THAT IT AND THE INFORMATION EMBODIED THEREIN SHALL BE USED ONLY FOR RECORD AND REFERENCE PURPOSES, SHALL NOT BE USED OR CAUSED TO BE USED IN ANY WAY PREJUDICIAL TO THE INTERESTS OF DANFOSS DRIVES, SHALL NOT BE REPRODUCED OR COPIED IN WHOLE OR IN PART, OR DISCLOSED TO ANYONE WITHOUT THE DIRECT WRITTEN PERMISSION OF DANFOSS DRIVES AND SHALL BE RETURNED UPON REQUEST.

DRN DTM
 APR DTM

NAME NEMA 3R,208V,2C
 , MAIN DISC, MAIN & DRIVE FUSE
 ,3MB1,CONTACT MOTOR SELECT,1 FAN
 MODEL VLT
 PAGE 2 OF 2
 SIZE A
 DWG NO. 185B0044

