

WARNING!
 THE FOLLOWING TABLE LISTS THE PARAMETERS THAT ARE SET DIFFERENT FROM THE DRIVE DEFAULT SETTINGS. ADDITIONAL PARAMETER SETTINGS MAY BE REQUIRED FOR YOUR APPLICATION.

DRIVE PARAMETER SETTINGS

PARAMETER #	NAME	SETTING	VALUE
0-02	MOTOR SPEED UNIT	1	HZ
0-03	REGIONAL SETTINGS	1	NORTH AMERICA
1-03	TORQUE CHAR.	3	AUTO ENERGY OPTIM VT
5-02	TERMINAL 29 TYPE	1	OUTPUT
5-11	TERMINAL 19	52	RUN PERMISSIVE
5-31	TERMINAL 29	5	RUNNING
5-40[0]	RELAY 1	160	NO ALARM
5-40[1]	RELAY 2	167	START COMMAND
14-20	RESET MODE	13	INFINITE AUTO REST

NOTES:

- * INDICATES COMPONENTS NOT SUPPLIED BY MANUFACTURER.
- REFER TO THE INSTALLATION AND OPERATION MANUAL FOR DRIVE FUNCTIONS AND PARAMETER SETTINGS.
- BRANCHCIRCUIT PROTECTION, INPUT POWER AND MOTOR WIRING MUST BE SELECTED IN ACCORDANCE WITH THE N.E.C., ANY APPLICATION LOCAL CODES AND THE LOAD CURRENT RATING.
- REPLACE JUMPER 'J1' WITH NORMALLY CLOSED SAFETY INTERLOCK CONTACT AS NECESSARY. CONTACT MUST BE RATED 1/4 HP @ 120VAC MINIMUM.
- PANEL MAY REQUIRE DERATING, CONSULT DRIVE MANUAL OR FACTORY FOR FOLLOWING CONDITIONS:
 - HIGHER SWITCHING FREQUENCY THAN DRIVE DEFAULT
 - HIGHER THAN PANEL LISTED AMBIENT TEMPERATURES
 - ELEVATION ABOVE 3300 FEET (1000 METERS)
 - LONG MOTOR LEAD LENGTHS

B			-NOTICE- THIS DRAWING IS PROPRIETARY AND SHALL NOT BE COPIED OR ITS CONTENTS DISCLOSED TO OUTSIDE PARTIES WITHOUT THE WRITTEN CONSENT OF THE TRANE COMPANY	DRN	NAME NEMA 3R,208V,2C				THE TRANE COMPANY A DIVISION OF AMERICAN STANDARD INC.	
A	SP10119	11/10		DTM	,MAIN & DRIVE DISC, DRIVE FUSE ,3MB2,IR,CONTACT MOTOR SELECT,1 FAN					
DR	SP10076	09/10		APR	MODEL	TR200	PAGE	1 OF 2	SIZE	A
REV	ECN	DATE		DTM			DWG NO.	185B2417		

WIRE COLOR SCHEME	
BLACK	- LINE VOLTAGE
RED	- AC CONTROL
WHITE	- AC GROUNDED
BLUE	- DC CONTROL
GREEN	- CHASSIS GROUND

TERMINAL IDENTIFICATION	
X	- DRIVE TERMINAL
⊗	- CUSTOMER TERMINAL

CUSTOMER DRY CONTACT RATINGS	
RELAY	CONTACT RATING
CR1, CR2, CR6, CR8, CR9	5A @ 120VAC 1/10 HP @ 120VAC
M2, M3, M4, M5	10A @ 120/240VAC
UV	8A @ 120VAC 1/3 HP @ 120VAC
TD1	4A @ 250VAC
DRIVE RELAY 1 & 2	2A @ 240VAC

CONTACT SEQUENCE CHART FOR S1 X INDICATES CONTACT CLOSED			
POSITION	DRIVE	OFF	BYPASS
13-14			X
23-24	X		

CONTACT SEQUENCE CHART FOR S2 X INDICATES CONTACT CLOSED			
POSITION	MOTOR 1	AUTO	MOTOR 2
11-12	X	X	
13-14			X
21-22		X	X
23-24	X		

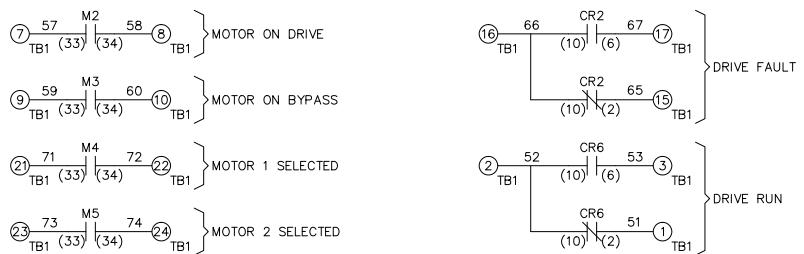
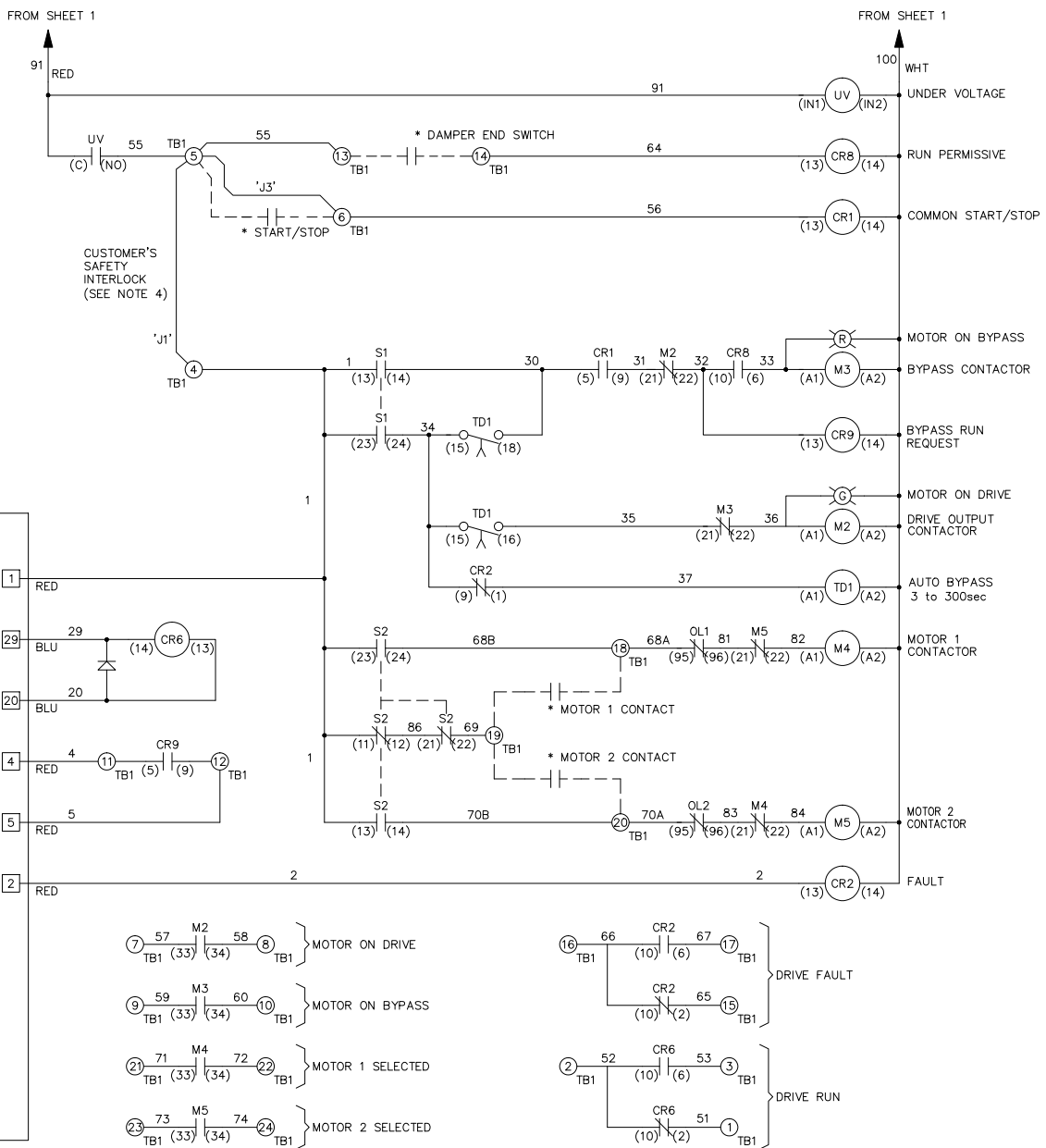
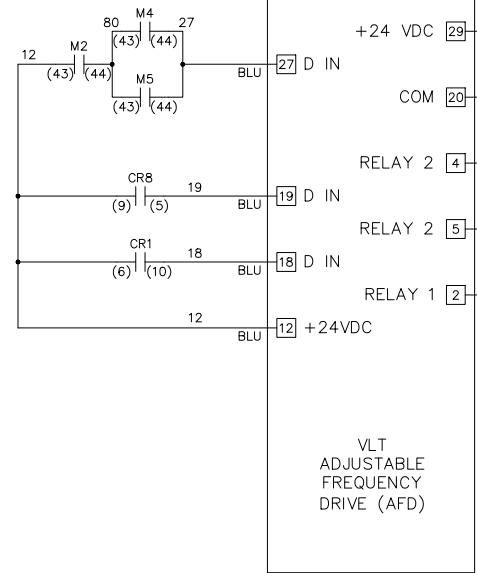

B		
A	SP10119	11/10
DR	SP10076	09/10
REV	ECN	DATE

-NOTICE-
THIS DRAWING IS PROPRIETARY AND SHALL NOT BE COPIED OR ITS CONTENTS DISCLOSED TO OUTSIDE PARTIES WITHOUT THE WRITTEN CONSENT OF THE TRANE COMPANY

DRN
DTM
APR
DTM

NAME
NEMA 3R, 208V, 2C
, MAIN & DRIVE DISC, DRIVE FUSE
, 3MB2, IR, CONTACT MOTOR SELECT, 1 FAN
MODEL TR200

THE TRANE COMPANY
A DIVISION OF
AMERICAN STANDARD INC.
PAGE 2 OF 2
SIZE A
DWG NO. 185B2417