

WIRE COLOR SCHEME	
BLACK	- LINE VOLTAGE
RED	- AC CONTROL
WHITE	- AC GROUNDED CIRCUIT CONDUCTOR
BLUE	- DC CONTROL
GREEN	- CHASSIS GROUND

TERMINAL IDENTIFICATION	
X	- DRIVE TERMINAL
X	- CUSTOMER TERMINAL

CUSTOMER DRY CONTACT RATINGS

RELAY	CONTACT RATING
CR1, CR2, CR6, CR8, CR9	5A @ 120VAC 1/10 HP @ 120VAC
M2, M3	10A @ 120/240VAC
UV	8A @ 120VAC 1/3 HP @ 120VAC
TD1	4A @ 250VAC
DRIVE RELAY 1 & 2	2A @ 240VAC

CONTACT SEQUENCE CHART FOR S1 X INDICATES CONTACT CLOSED				
CONTACT	POSITION	DRIVE	OFF	BYPASS
13-14				X
23-24		X		

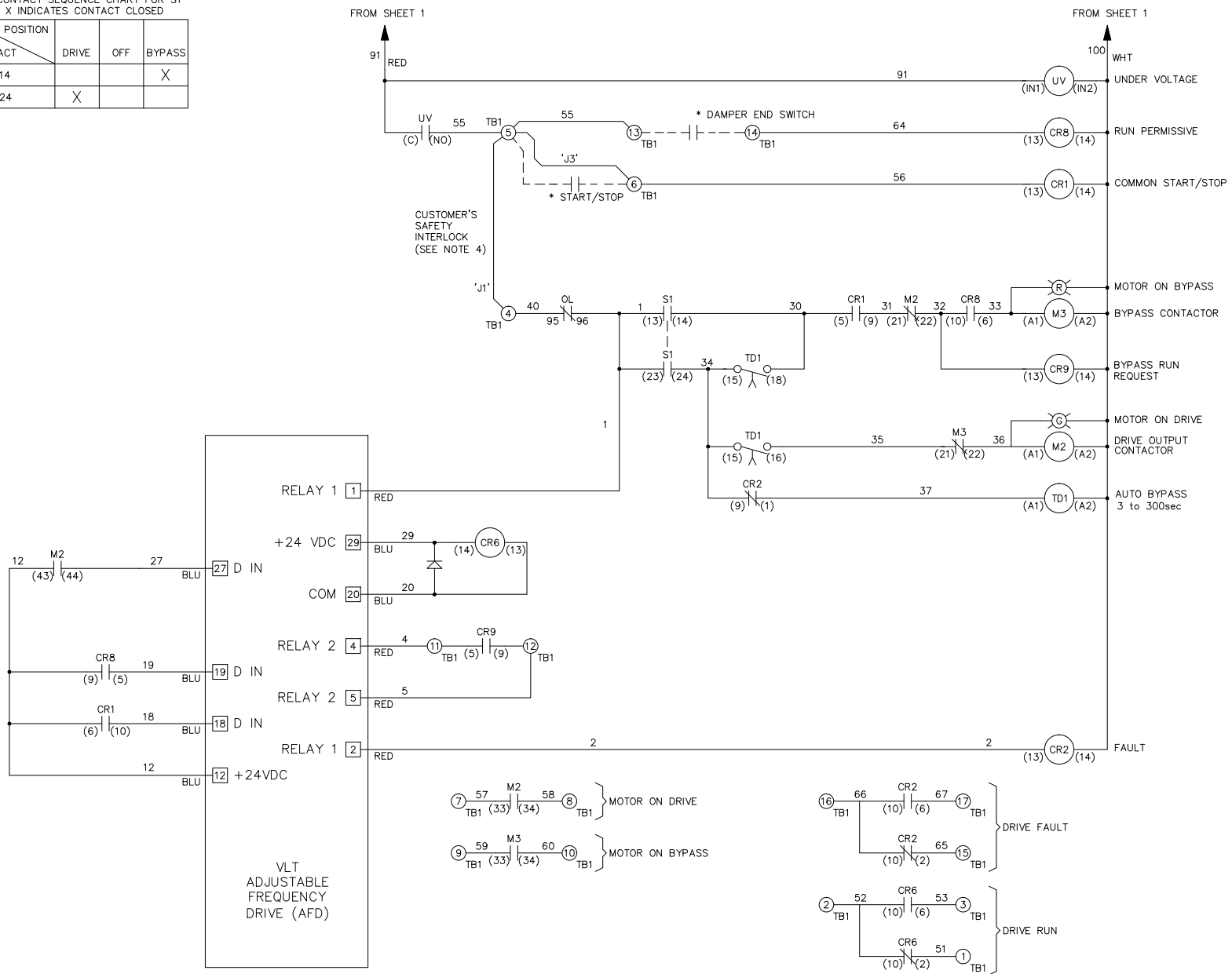

B		
A	SP10119	11/10
DR	SP10076	09/10
REV	ECN	DATE

-NOTICE-

THIS DRAWING IS PROPRIETARY AND SHALL NOT BE COPIED OR ITS CONTENTS DISCLOSED TO OUTSIDE PARTIES WITHOUT THE WRITTEN CONSENT OF THE TRANE COMPANY

DRN
DTM

APR
DTM

NAME
NEMA 3R,208V,2C
,MAIN & DRIVE DISC, MAIN & DRIVE FUSE
,3MB2,SINGLE MOTOR,1 FAN

MODEL
TR200

PAGE 2 OF 2

SIZE
A

THE TRANE COMPANY
A DIVISION OF
AMERICAN STANDARD INC.

DWG NO. 185B2448