



WIRE COLOR SCHEME  
 BLACK - LINE VOLTAGE  
 RED - AC CONTROL  
 WHITE - AC GROUNDED  
 CIRCUIT CONDUCTOR  
 BLUE - DC CONTROL  
 GREEN - CHASSIS GROUND

TERMINAL IDENTIFICATION  
 [X] - DRIVE TERMINAL  
 (X) - CUSTOMER TERMINAL

CUSTOMER DRY CONTACT RATINGS

RELAY	CONTACT RATING
CR6	5A @ 120VAC 1/10 HP @ 120VAC
M2, M3	10A @ 120/240VAC

CONTACT SEQUENCE CHART FOR S1  
 X INDICATES CONTACT CLOSED

POSITION	DRIVE	OFF	BYPASS
13-14			X
23-24	X		

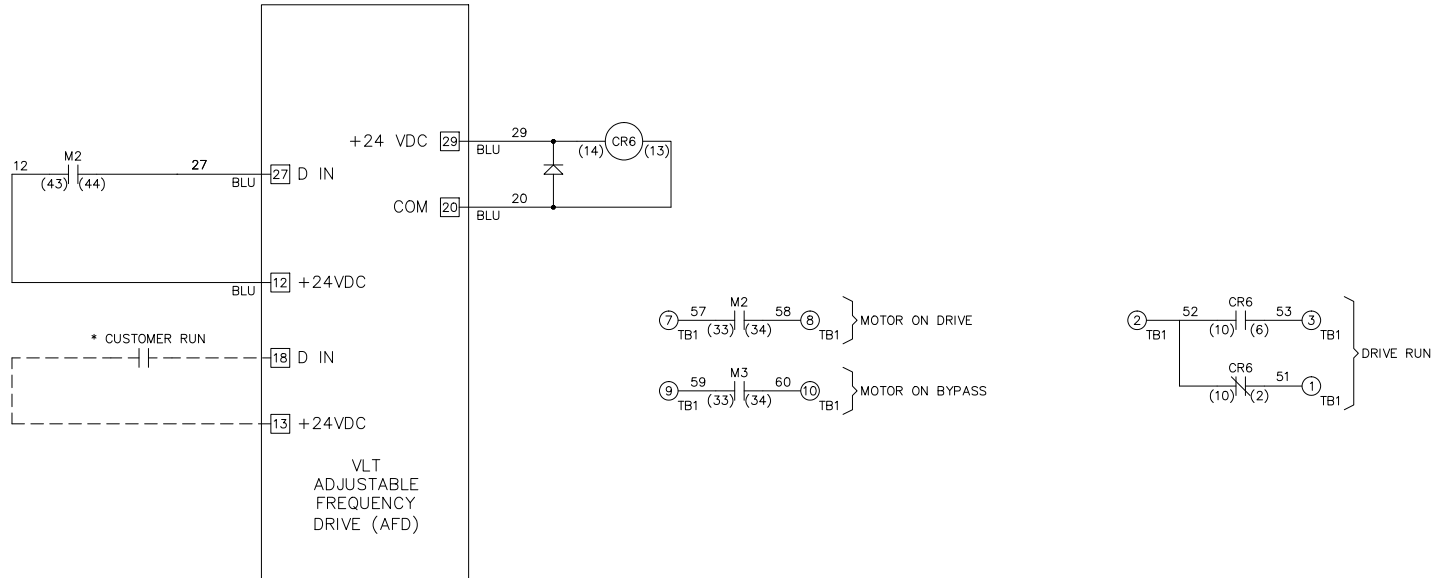

B			<p align="center">-NOTICE-</p> <p>THIS DRAWING IS PROPRIETARY AND SHALL NOT BE COPIED OR ITS CONTENTS DISCLOSED TO OUTSIDE PARTIES WITHOUT THE WRITTEN CONSENT OF THE TRANE COMPANY</p>	DRN <i>DTM</i>	NAME NEMA 3R,208V,2C ,MAIN CB ,DRIVE FUSE ,3MB,DUAL MOTOR,4 FAN		THE TRANE COMPANY A DIVISION OF AMERICAN STANDARD INC.	
A	SP10119	11/10		APR <i>DTM</i>	MODEL TR200	PAGE 2 OF 2	SIZE A	DWG NO. 185B3973
DR	SP10076	09/10						
REV	ECN	DATE						