

SCALE 1:5

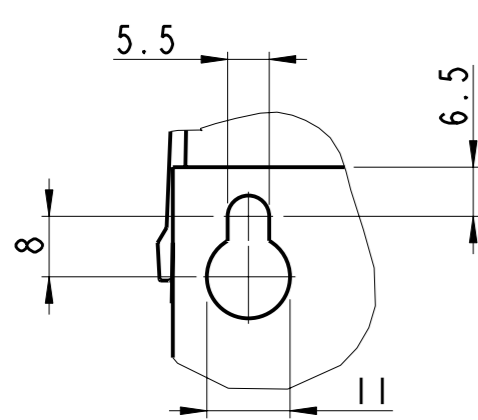

DETAIL A
SCALE 1:1

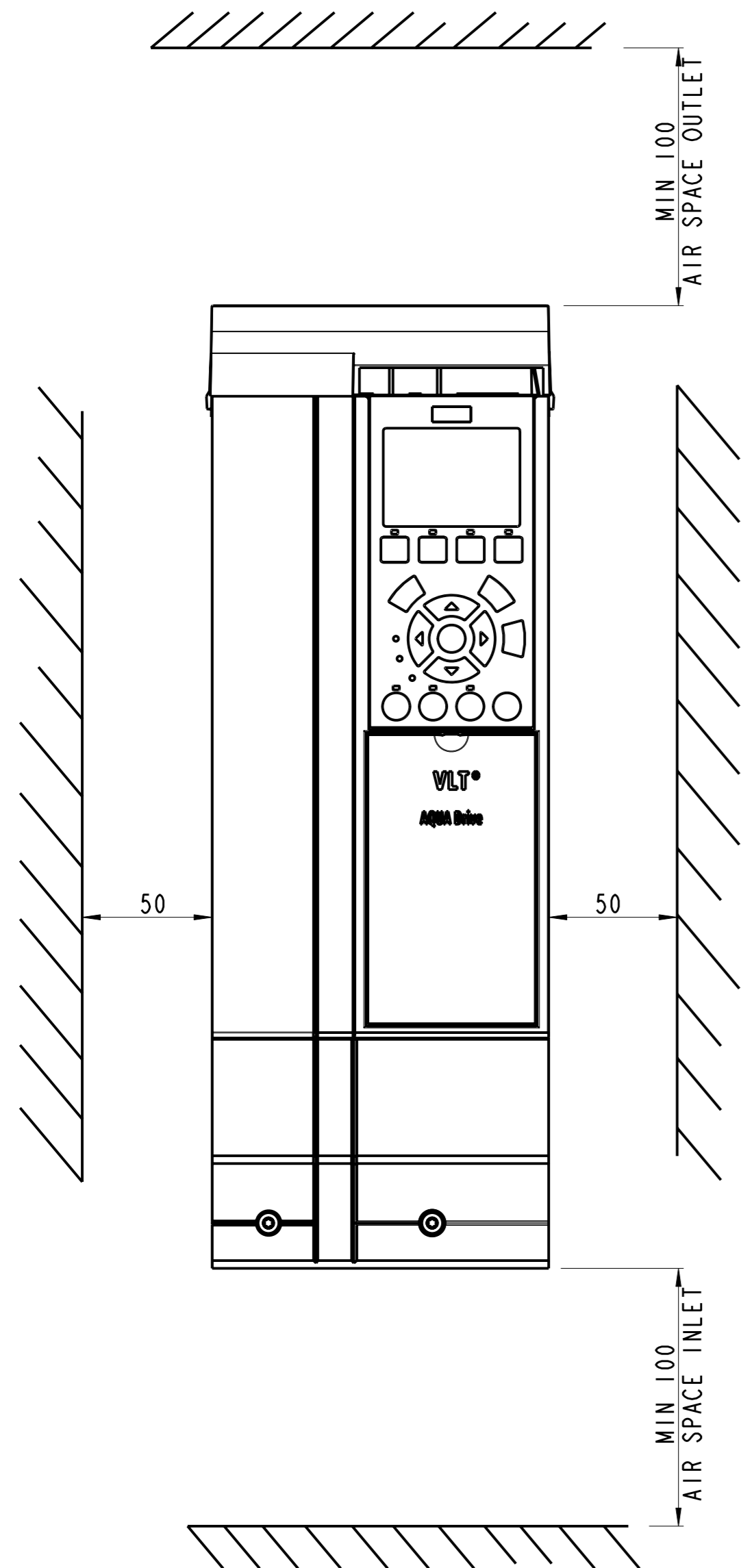
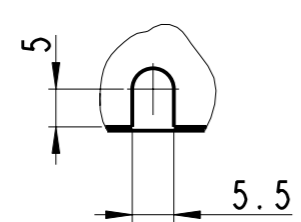

DETAIL B
SCALE 1:1

Projection 	Scale / Paper size 1:2 / A1	Mater. / Spec. -----
		Danfoss standard -----
Last revised by JHK	Date 2007.03.07	Designation ENCLOSURE-A3-1P21
<small>Confidential: Property of Danfoss Drives A/S. Not to be handed over to, copied or used by third party. Two- or three dimensional reproduction of contents to be authorized by Danfoss Drives A/S.</small>		Part no. DANFOSS-FC200-A3-1P21-055 1 of 1
<small>PDM controlled drawing. - Hard copy not valid without frozen date in ID stamp.</small>		Rev. 001

Model: DANFOSS-FC200-A3-1P21-055-PART