

SCALE 1:10

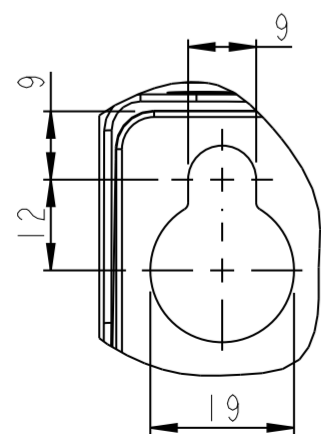

DETAIL A
SCALE 1:1

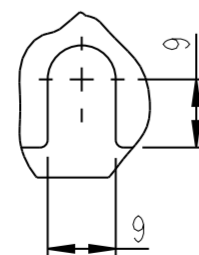

DETAIL B
SCALE 1:1

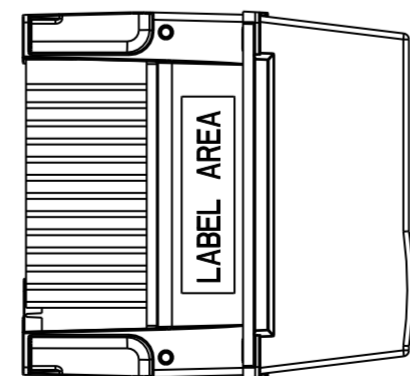

Projection 	Scale / Paper size 1:5 / A2		Matr. /Spec. ---
Last revised by -			Date 2008.07.07
Confidential: Property of Danfoss Drives A/S. Not to be handed over to, copied or used by third party. Two- or three dimensional reproduction of contents to be authorized by Danfoss Drives A/S.			Designation ENCLOSURE-B2-1P21
PDM controlled drawing. - Hard copy not valid without frozen date in ID stamp.			Part no. DANFOSS-FC200-B2-1P21-165 1 of 1 Rev. 001