

KIT INTERSTAGE PIPE

100703-1



Installation and servicing of Danfoss Turbocor® compressors by qualified and product trained personnel only. Follow these instructions and sound refrigeration/electrical/servicing practices relating to installation, commissioning, maintenance and service.

<p>Consult the appropriate Danfoss Turbocor Compressors Inc. (DTC) Service Manual on www.turbocoroem.com for detailed service instructions.</p>	<p>Never power compressor without covers in place and secured.</p> <p>Removing the mains input cover will expose you to a voltage hazard of up to 575V. Ensure the mains input power is off and locked out before removing cover.</p> <p>Before removing top cover, wait at least 20 minutes after isolating AC power to allow the high voltage capacitors to discharge.</p>	<p>Always wear appropriately rated safety equipment when working around equipment and/or components energized with high voltage.</p> <p>This equipment contains hazardous voltages that can cause serious injury or death.</p>	<p>Recover all refrigerant from compressor in accordance with local codes and ensure pressure is fully vented before the removal of refrigerant containing components.</p>
--	---	---	---

1 - Introduction:

INTERSTAGE PIPE Removal and installation.

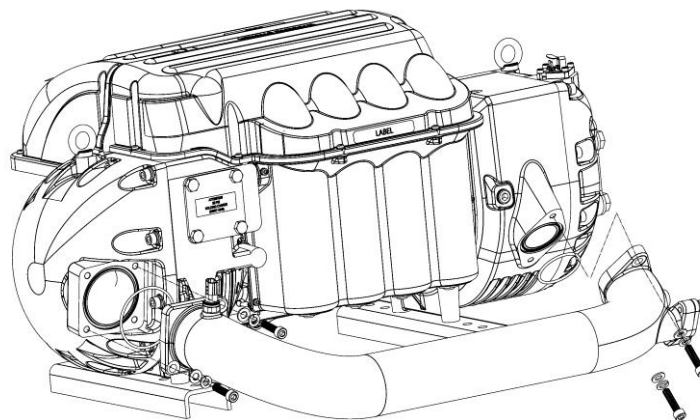

This kit contains the Interstage Pipe as well as the required O-rings and fasteners. Please refer to our Service Manual for details regarding the replacement of the Interstage Pipe.

We have made the **TTS/TGS/TTH/TGH Service Manual** available to anyone. To access the manual, you may scan the applicable QR code below or you may go to our DTC website at www.turbocoroem.com. At the top of the page there is a pull-down menu called "Quick Links." Click this menu and select the appropriate service manual.

Refer to the applicable QR code below to download the TTS/TGS/TTH/TGH Service Manual.

English



Chinese







2 - INTERSTAGE PIPE Removal Instructions:

1. Isolate compressor power.
2. Isolate the compressor and recover the refrigerant according to industry standards.
3. Remove the Interstage Pipe.
4. Discard the old O-rings and fasteners.

3 - INTERSTAGE PIPE Installation Instructions:

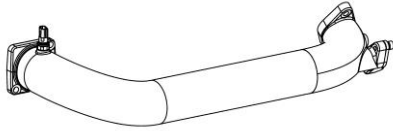
1. Install the Interstage Pipe with the new O-rings and fasteners.
2. Install the new P/T sensor included with the kit.
3. Leak test and evacuate compressor in accordance with standard industry practices.
4. Return the compressor to normal operation.

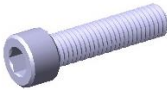
4 - Kit Contents:

QTY	Part(s) Description	Picture(s)
1	INTERSTAGE PIPE ASSEMBLY	
1	SENSOR ASSEMBLY-PRESS/TEMP-M12X1.25, WITH O-RING	
4	SCREW M10X40, SOCKET HEAD CAP	
2	SCREW M10X30 SOCKET HEAD CAP	
6	WASHER M10 SPLIT LOCK	

6	WASHER M10 FLAT	
1	O-RING - E0740-75 2-229	
1	O-RING, INTERSTAGE - E0740-75 2-237	
1	O-RING - E0740 2-220	
1	LUBRICATION-SUPER-O-LUBE-2G	

Danfoss can accept no responsibility for possible errors in catalogues, brochures and other printed material. Danfoss reserves the right to alter its products without notice. This also applies to products already on order provided that such alterations can be made without subsequential changes being necessary in specifications already agreed. All trademarks in this material are property of the respective companies. Danfoss and the Danfoss logotype are trademarks of Danfoss A/S. All rights reserved.