

ECONOMIZER FLANGE

100400 & 100450-1.

 <p>Installation and servicing of Danfoss Turbocor® compressors by qualified and product trained personnel only. Follow these instructions and sound refrigeration/electrical/servicing practices relating to installation, commissioning, maintenance, and service.</p>			
<p>Consult the appropriate Danfoss LLC Service Manual on turbocoroem.com for detailed service instructions.</p>	<p>Never power compressor without covers in place and secured.</p> <p>Removing the mains input cover will expose you to a voltage hazard of up to 853VDC. Ensure the mains input power is off and locked out before removing cover.</p> <p>Before removing top cover, wait at least 20 minutes after isolating AC power to allow the high voltage capacitors to discharge.</p>	<p>Always wear appropriately rated safety equipment when working around equipment and/or components energized with high voltage.</p> <p>This equipment contains hazardous voltages that can cause serious injury or death.</p>	<p>Recover all refrigerant from compressor in accordance with local codes and ensure pressure is fully vented before the removal of refrigerant containing components.</p>

1 - Introduction

ECONOMIZER FLANGE Removal and Installation Instructions.

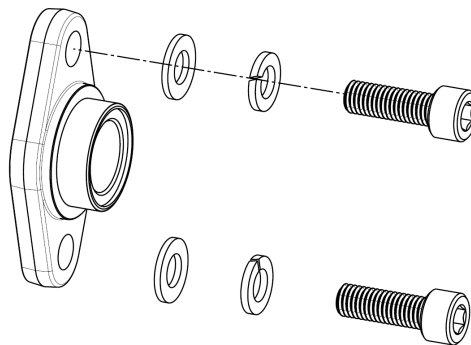

Figure 1 – Economizer Flange (TTS300 shown)

This kit contains the Economizer Flange, O-ring, and associated hardware.

We have made the **TT Series Service Manual** available to anyone. To access the manual, you may scan the applicable QR code below or you may go to our DTC website at <http://www.turbocoroem.com>. At the bottom of the page there is a Section named “Categories” that includes various menus including one for Manuals.

Refer to the applicable QR code below to download the TT Series Service Manual.

English



Chinese



2 - Installation Instructions

1. Isolate compressor power.
2. Isolate the compressor and recover the refrigerant according to industry standards.
1. Remove Cover Plate and align economizer pipe and flange.
2. Complete the flange welding or brazing process.
3. Clean, lubricate, and install the O-ring into the groove in the compressor housing.
4. Assemble the two (2) M10x30 fasteners and the four (4) M10 washers.
5. Align the economizer valve/flange with the compressor economizer port (refer to Figure 1) and insert the two (2) fasteners.
6. Finger-tighten the fasteners and then torque them to 32 Nm (24 ft.lb.).
7. Leak test and evacuate compressor in accordance with standard industry practices.
8. Return the compressor to normal operation.

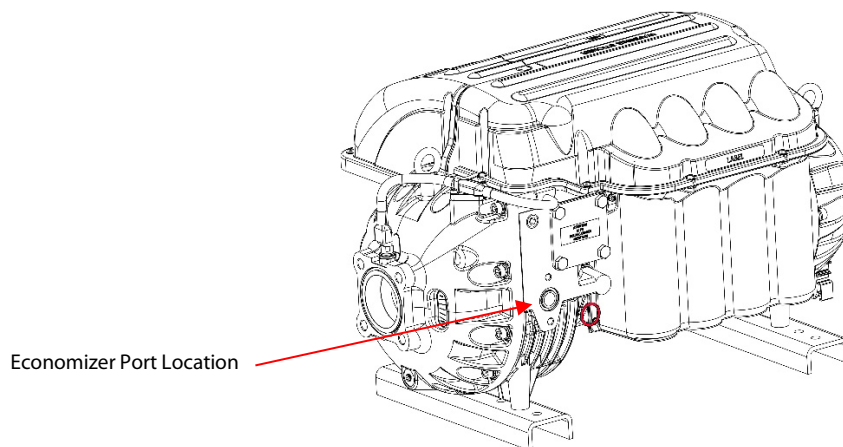

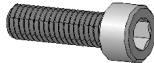



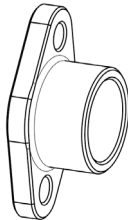

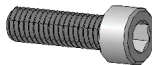





Figure 2 – Economizer Port Location

3 - Kit Contents

Note: Any part numbers included in the kit contents are internal part numbers only. Please refer to our Spare Parts Manuals for any kit part numbers.

KIT	100400	
QTY	Part(s) Description	Picture(s)
1	FLANGE SWEAT (ECONOMIZER)	
2	WASHER, M10 SPLIT – 902839	
2	SCREW, M10X30, SOCKET HEAD CAP – 902846	
2	WASHER, M10 FLAT – 902836	
1	O-RING, FLANGE – 901851	
1	LUBRICATION-SUPER O-LUBE-2G	

KIT	100450-1	
QTY	Part(s) Description	Picture(s)
1	FLANGE SWEAT (ECONOMIZER)	
2	WASHER, M10 SPLIT – 902839	
2	SCREW, M10X30, SOCKET HEAD CAP – 902846	
2	WASHER, M10 FLAT – 902836	
1	O-RING, FLANGE – 901852	
1	LUBRICATION-SUPER O-LUBE-2G	



4 - List of Changes

Revision	Date	Description of Change
N	8/2/2023	Complete update Removed the obsolete kit - 100450

Danfoss LLC can accept no responsibility for possible errors in catalogues, brochures, and other printed material. Danfoss LLC reserves the right to alter its products without notice. This also applies to products already on order provided that such alterations can be made without subsequential changes being necessary in specifications already agreed. All trademarks in this material are property of the respective companies. Danfoss and the Danfoss logotype are trademarks of Danfoss A/S. All rights reserved.