

KIT CABLE HARNESS FOR SOFT START AC/DC (TT300/TG230)

100380.



Installation and servicing of Danfoss Turbocor® compressors by qualified and product trained personnel only. Follow these instructions and sound refrigeration/electrical/servicing practices relating to installation, commissioning, maintenance and service.

<p>Consult the appropriate Danfoss Turbocor Compressors Inc. (DTC) Service Manual on turbocoroem.com for detailed service instructions.</p>	<p>Never power compressor without covers in place and secured.</p> <p>Removing the mains input cover will expose you to a voltage hazard of up to 575V. Ensure the mains input power is off and locked out before removing cover.</p> <p>Before removing top cover, wait at least 20 minutes after isolating AC power to allow the high voltage capacitors to discharge.</p>	<p>Always wear appropriately rated safety equipment when working around equipment and/or components energized with high voltage.</p> <p>This equipment contains hazardous voltages that can cause serious injury or death.</p>	<p>Recover all refrigerant from compressor in accordance with local codes and ensure pressure is fully vented before the removal of refrigerant containing components.</p>
---	---	---	---

1 - Introduction

CABLE HARNESS FOR SOFT START AC/DC Removal and Installation Instructions.

There are two (2) variants of the DC-DC Converter mentioned in these instructions. There is a potted style and an open-frame style DC-DC Converter. The open-frame style utilizes three (3) connectors whereas the potted style uses four (4). The open-frame design no longer uses the 15VAC trigger signal from the Soft Start, thus eliminating the need for J4. Refer to the following two figures for proper identification of the two (2) DC-DC Converter styles.

Figure 1 – Open Frame DC-DC Converter

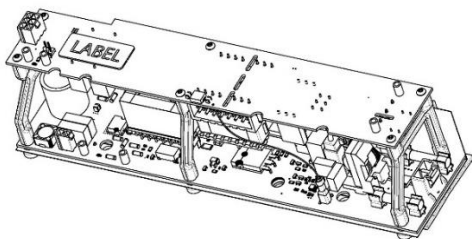
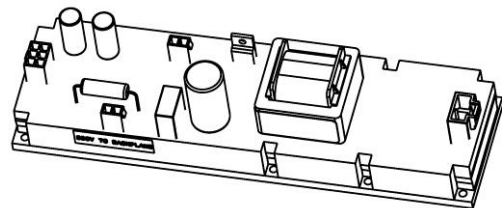

Figure 2 – Potted DC-DC Converter



This kit includes two (2) cables in order to accommodate either DC-DC Converter style.

2 - SOFT START CABLE HARNESS Removal Instructions:

1. Isolate compressor power as described in the Electrical Isolation of the Compressor section of the Service Manual (M-SV-001).
2. Remove the Mains Input Cover by releasing the fasteners that secure the Mains input cover and remove the cover.
3. Release the fasteners that secure the Top Cover and remove the cover.
4. Release the fasteners that secure the Service Cover and remove the cover.

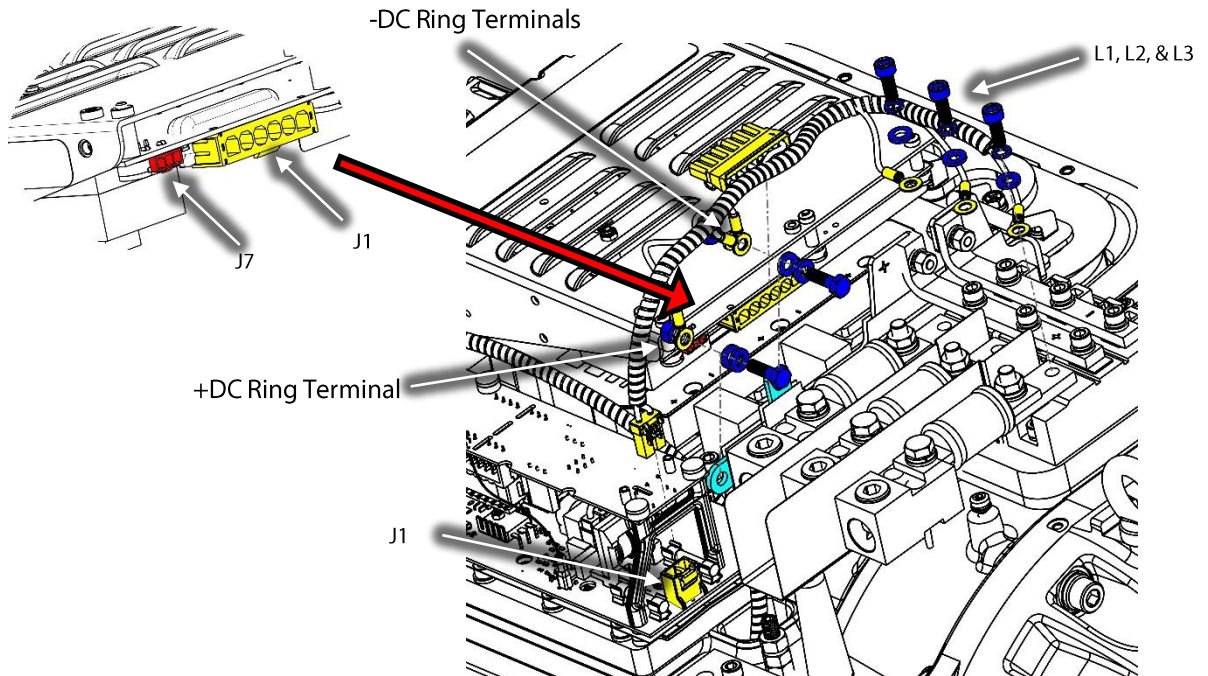

Figure 3 – Soft Start AC-DC Harness Removal

5. Disconnect the three (3) ring terminals labeled L1, L2, and L3 from the AC bus bars. Refer to Figure 3 (Soft Start AC-DC Harness Removal) for this and the next three (3) steps.
6. Disconnect the two (2) -DC ring terminals from the -DC bus bar by removing the attaching hardware.
7. Disconnect the +DC ring terminal from the +DC bus bar by removing the attaching hardware.
8. Remove the J1 DC-DC connector from the DC-DC Converter. Refer to Figure 3 (Soft Start AC-DC Harness Removal) if this compressor contains the Open Frame DC-DC Converter, or to Figure 4 (Potted DC-DC Converter J1 and J4 Locations) if this is a Potted DC-DC Converter.
9. If the DC-DC Converter is the potted style, remove the J4 connector from the DC-DC Converter. Refer to Figure 4 (Potted DC-DC Converter J1 and J4 Locations).

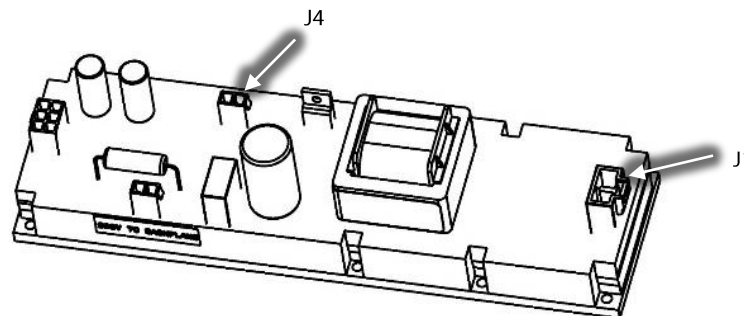

Figure 4 – Potted DC-DC Converter J1 and J4 Locations

10. If the DC-DC Converter is the potted style, remove the J7 connector from the Soft Start. Refer to Figure 3 (Soft Start AC-DC Harness Removal) for this and the following step.
11. Remove the "J1: High Voltage AC/DC" Soft Start connector.
12. Remove the harness.

3 - SOFT START CABLE HARNESS Installation Instruction:

Note: Use harness **720358** for the potted DC-DC Converter and **701567** for the open frame DC-DC Converter.

1. Place the wiring harness on top of the compressor. Refer to Figure 3 (Soft Start AC-DC Harness Removal) for this and the next five (5) steps.
2. Install the "J1: High Voltage AC/DC" Soft Start connector.
3. Connect the +DC ring terminal to the +DC bus bar with the attaching hardware.
4. Connect the two (2) -DC ring terminals to the -DC bus bar with the attaching hardware. Torque the fasteners to 10 Nm (89 in.lb.).
5. Connect the three (3) ring terminals labeled L1, L2, and L3 from the AC bus bars. Torque the M6x16 fasteners to 5 Nm (44 in.lb.).
6. If the DC-DC Converter is the potted style, install the J7 Soft Start connector.
7. Install the J1 DC-DC connector to the DC-DC Converter. Refer to Figure 3 (Soft Start AC-DC Harness Removal) if this compressor contains the Open Frame DC-DC Converter, or to Figure 4 (Potted DC-DC Converter J1 and J4 Locations) if this is a Potted DC-DC Converter.
8. If the DC-DC Converter is the potted style, install the J4 connector to the DC-DC Converter. Refer to Figure 4 (Potted DC-DC Converter J1 and J4 Locations).
9. Install Covers. Refer to the Cover section below.
10. Reconnect power.

Cover Installation

1. Ensure that no dirt/debris is on the contact surfaces of Top Cover and casting sides.
2. Place the Top Cover and secure it with the fasteners according to the following sequence. Follow the sequence twice. The first time, only thread the fasteners half way down to allow for adjustments. Torque to 13 in.lb. on the second pass. Refer to Figure 5 (Top Cover Install).

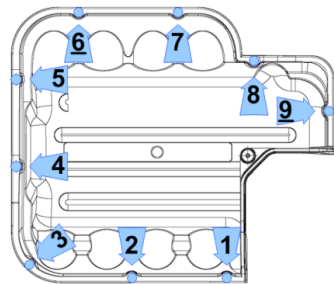

Figure 5 – Top Cover Install

3. Ensure that no dirt/debris is on the contact surfaces of the Mains Input Cover and casting sides.
4. Place the New Mains Input Cover and secure it with the fasteners. Tighten according to the following sequence. Refer to Figure 6 (Mains Input Cover Install).

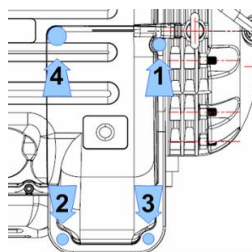

Figure 6 – Mains Input Cover Install







5. Follow the sequence twice. The first time, only thread the fasteners to half way down to allow for adjustment. Torque to 13 in.lb. on the second pass. Fasten the # 4 fastener only once and use caution as to not overtighten this fastener.

4 - Fastener Torque

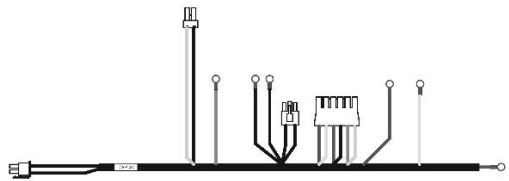
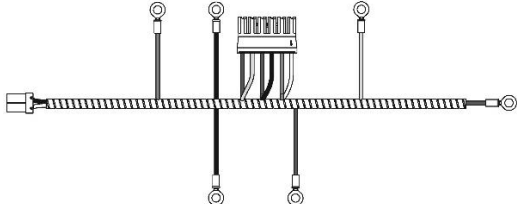
Fastener Description	Nm	Ft.Lb.	In.Lb.
Soft Start DC+ & DC- to DC Bus Bolt/nut	10	7	89
AC Bus Bar to SCR Fastener, M6x16	5	-	44
Cover Fastener, M5x15	-	-	13

5 - Kit Contents

Kit numbers	Compressor models
100380	TT300 / TG230

QTY	Part(s) Description	Picture(s)
1	KIT-CABLE HARNESS SOFT START AC/DC (720358 – for potted DC-DC Converter)	
1	KIT-CABLE HARNESS SOFT START AC/DC (701567 – for open frame DC-DC Converter)	
3	SCREW, M6x16 SOCKET HEAD CAP	
5	WASHER, M6 SPLIT LOCK	
7	WASHER, M6 FLAT	
2	SCREW, M6x20 HEX HEAD CAP	
2	NUT M6 HEX	

Danfoss can accept no responsibility for possible errors in catalogues, brochures and other printed material. Danfoss reserves the right to alter its products without notice. This also applies to products already on order provided that such alterations can be made without subsequential changes being necessary in specifications already agreed. All trademarks in this material are property of the respective companies. Danfoss and the Danfoss logotype are trademarks of Danfoss A/S. All rights reserved.