

ENGINEERING
TOMORROW



Application Guide

iC7 Series Industry

OPEN UP A NEW DIMENSION OF INTELLIGENCE

PROGRAMMABLE
PREDICTIVE MAINTENANCE
DATA SECURITY
CONNECTIVITY
APPLICATION PERFORMANCE
EFFICIENCY



Scan for more
documentation

www.danfoss.com

iC7

Contents

1 Introduction to the Application Guide

1.1 Version History	11
1.2 Purpose of this Application Guide	11
1.3 Additional Resources	11
1.4 Safety Symbols	11

2 Industry Application Software Overview

2.1 Industry Application Overview	13
2.2 Basic Functions	13
2.2.1 I/O Control and Readouts	13
2.2.2 Reference Handling	13
2.2.3 Ramps	13
2.2.4 Quick Stop	13
2.2.5 Limit Rotation Direction	13
2.2.6 Inching with Jogging Modes	13
2.2.7 Speed Bypass	13
2.2.8 Flying Start	14
2.2.9 Mains Dropout	14
2.2.10 Kinetic Backup	14
2.2.11 Resonance Damping	14
2.2.12 Motor Preheating	14
2.2.13 Mechanical Brake Control	14
2.2.14 Load Drooping	14
2.3 Controllers	14
2.3.1 Speed Controller	14
2.3.2 Torque Controller	14
2.3.3 Process Control	15
2.4 Motor Control Features	15
2.4.1 Motor Types	15
2.4.2 Torque Characteristics	15
2.4.3 Motor Control Principles	15
2.4.4 Motor Nameplate Data	15
2.4.5 Automatic Motor Adaptation (AMA)	15
2.4.6 Automation Energy Optimization (AEO)	15

2.5 Braking of Load	15
2.5.1 Overview of Braking of Load	15
2.5.2 Resistor Braking	16
2.5.3 Overvoltage Control (OVC)	16
2.5.4 DC Brake	16
2.5.5 AC Brake	16
2.5.6 DC Hold	16
2.5.7 Load Sharing	16
2.6 Protection Features	16
2.6.1 Grid Protection	16
2.6.2 Drive Protection Features	16
2.6.3 Motor Protection Features	17
2.6.4 Protection of External Filters or Brake Resistors	17
2.6.5 Automatic Derating	17
2.7 Monitoring, Logging, and History Log	17
2.7.1 Monitoring Features	17
2.7.2 Event Log	17
2.7.3 Logging and Storage of Data	18
2.8 Functional Safety	18
2.9 Software Tools	18
2.9.1 Overview of Software Tools	18
2.9.2 MyDrive® Select	18
2.9.3 MyDrive® Harmonics	18
2.9.4 MyDrive® ecoSmart™	18
2.9.5 MyDrive® Insight	19
2.10 Security Features	19
2.11 Motor Control Features for FVC+ and VVC+ Control	19
2.11.1 Compatibility of Motor Control Features for FVC+ and VVC+ Control	19
2.11.2 High Frequency Voltage Injection	21
2.12 PROFIdrive - Standard Telegram 1	22
2.12.1 Overview of PROFIdrive - Standard Telegram 1	22
2.12.2 Control Word (CTW) in PROFIdrive Standard Telegram 1	23
2.12.3 Status Word (STW) in PROFIdrive Standard Telegram 1	24
2.12.4 PROFIdrive State Machine	25
2.13 iC Speed Profile	26
2.13.1 Overview of iC Speed Profile	26

2.13.2 Control Word (CTW) in iC Speed Profile	26
2.13.3 Status Word (STW) in iC Speed Profile	28

3 User Interfaces

3.1 Overview of User Interfaces	30
3.2 Control Panel	30
3.2.1 iC7 Control Panel Options	30
3.2.2 Control Panel Elements	31
3.2.3 Control Panel Basic Configurations	33
3.2.4 Starting the Drive and Control Panel Display	33
3.2.5 Understanding Readout Screens	33
3.2.6 Adjusting Display Backlight and Contrast	35
3.2.7 Changing the Content of the Readout Screens	35
3.2.8 Parameter Group Screen and Overall Navigation	36
3.2.9 Changing the Selections of a Parameter	37
3.2.10 Changing a Parameter Value	38
3.2.11 Locking the Control Panel Display	38
3.2.12 Control Panel Shortcuts	39
3.3 MyDrive® Insight	39
3.3.1 Introduction to MyDrive® Insight	39
3.3.2 Getting Started with MyDrive Insight	40
3.3.3 Accessing Parameters and Understanding Parameter Screens in MyDrive® Insight	41
3.3.4 Viewing and Changing Parameter Settings	43
3.3.5 PC Control: Operating the Drive Using MyDrive® Insight	45
3.3.6 Datalogger	46
3.3.6.1 Introduction to Datalogger	46
3.3.6.2 Configuring Datalogger	47
3.3.7 Backup and Restore	52
3.3.7.1 MyDrive® Insight Backup	52
3.3.7.2 Backing up the Drive	53
3.3.7.3 Restoring the Data to the Drive	54

4 Application Software Structure and Overview

4.1 Understanding Application Software Structure Principles	57
4.2 Parameter Groups and their Content	57

5 Configuration Set-up Examples

5.1 Configuration Prerequisites	60
5.2 Basic Setup of a Drive	61
5.3 Configuring the Motor, Motor Control, and Motor Thermal Protection	62
5.4 Configuring Speed Control	64
5.5 Configuring Torque Control	67
5.6 Configuring Process Control	70

6 Parameter Descriptions

6.1 Introduction to Parameter Descriptions	74
6.1.1 Reading the Parameter Table	74
6.1.2 Understanding Data Types	74
6.1.3 Understanding Parameter Types	75
6.1.4 Understanding Access Types	75
6.2 Grid (Menu Index 1)	75
6.2.1 Grid Overview	75
6.2.2 Grid Status (Menu Index 1.1)	75
6.2.3 Grid Settings (Menu Index 1.2)	77
6.2.4 Grid Protection (Menu Index 1.3)	78
6.3 Power Conversion & DC Link (Menu Index 2)	79
6.3.1 Power Conversion & DC-Link Overview	79
6.3.2 Power Conversion & DC Link Status (Menu Index 2.1)	79
6.3.3 Power Unit Settings (Menu Index 2.2)	81
6.3.3.1 General Settings (Menu Index 2.2.1)	81
6.3.3.2 Additional Information for Power Unit General Settings	85
6.3.3.3 Cooling Fan Control (Menu Index 2.2.2)	87
6.3.4 Protection (Menu Index 2.3)	88
6.3.4.1 Settings (Menu Index 2.3.1)	88
6.3.4.2 Additional Information for Power Unit Protection Settings	91
6.3.4.3 Overvoltage Protection (Menu Index 2.3.2)	92
6.3.4.4 Additional Information for Overvoltage Protection	93
6.3.4.5 Power Loss (Menu Index 2.3.3)	93
6.3.4.6 Additional Information for Power Loss	95
6.3.5 Modulation (Menu Index 2.4)	96
6.4 Filters & Brake Chopper (Menu Index 3)	97
6.4.1 Filters & Brake Chopper Overview	97

6.4.2	Filters & Brake Chopper Status (Menu Index 3.1)	97
6.4.3	Brake Chopper (Menu Index 3.2)	97
6.4.4	Brake Resistor (Menu Index 3.3)	98
6.4.5	Additional Information for Brake Resistor	99
6.4.6	Advanced Harmonic Filter (Menu Index 3.4)	99
6.4.7	Output Filter (Menu Index 3.5)	100
6.4.8	Additional Information for Output Filter	101
6.5	Motor (Menu Index 4)	101
6.5.1	Motor Overview	101
6.5.2	Motor Status (Menu Index 4.1)	101
6.5.3	Motor Data (Menu Index 4.2)	105
6.5.3.1	General Settings (Menu Index 4.2.1)	105
6.5.3.2	Additional Information for Motor Data General Settings	107
6.5.3.3	Overview of Motor Nameplate Data	109
6.5.3.4	Motor Nameplate Data (Menu Index 4.2.2)	109
6.5.3.5	Induction Motor (Menu Index 4.2.3)	110
6.5.3.6	Additional Information for Induction Motor	111
6.5.3.7	Permanent Magnet Motor (Menu Index 4.2.4)	111
6.5.4	Motor Control (Menu Index 4.3)	113
6.5.4.1	General Settings (Menu Index 4.3.1)	113
6.5.4.2	Running a Motor Feedback Test	114
6.5.4.3	Overview of U/f Settings	115
6.5.4.4	U/f Settings (Menu Index 4.3.2)	115
6.5.4.5	FVC+ Settings (Menu Index 4.3.3)	117
6.5.4.6	VVC+ & U/f Settings (Menu Index 4.3.4)	120
6.5.4.7	Additional Information for VVC+ & U/f Settings	123
6.5.5	Protection (Menu Index 4.5)	123
6.6	Application (Menu Index 5)	126
6.6.1	Application Overview	126
6.6.2	Application Status (Menu Index 5.1)	126
6.6.3	Application Status Word Descriptions	127
6.6.4	Protection (Menu Index 5.2)	130
6.6.4.1	Cooling Monitor (Menu Index 5.2.1)	130
6.6.4.2	External Event (Menu Index 5.2.2)	131
6.6.4.3	Additional Information for External Event	133
6.6.4.4	Measured Temp. Protection (Menu Index 5.2.3)	133
6.6.4.5	Blocked Rotor Detection	139

6.6.4.6	Blocked Rotor Detection (Menu Index 5.2.6)	139
6.6.4.7	Lost Load Detection (Menu Index 5.2.7)	140
6.6.4.8	HMI Connection Loss (Menu Index 5.2.9)	140
6.6.4.9	Live Zero (Menu Index 5.2.15)	141
6.6.4.10	Feedback Handling (Menu Index 5.2.16)	141
6.6.5	Load (Menu Index 5.3)	142
6.6.5.1	Load Status (Menu Index 5.3.1)	142
6.6.5.2	Inertia (Menu Index 5.3.2)	142
6.6.5.3	Torque & AEO (Menu Index 5.3.3)	143
6.6.6	Operation Mode (Menu Index 5.4)	144
6.6.6.1	Settings (Menu Index 5.4.2)	144
6.6.7	Control Places (Menu Index 5.5)	145
6.6.7.1	Control Places Overview	145
6.6.7.2	Control Places Status (Menu Index 5.5.1)	146
6.6.7.3	Control Place Settings (Menu Index 5.5.2)	147
6.6.7.4	Local Control (Menu Index 5.5.3)	148
6.6.7.5	Fieldbus control (Menu Index 5.5.4)	151
6.6.7.6	I/O Control (Menu Index 5.5.5)	154
6.6.7.7	Advanced control (Menu Index 5.5.6)	159
6.6.8	Start Settings (Menu Index 5.6)	166
6.6.8.1	Start Settings Overview	166
6.6.8.2	General Settings (Menu Index 5.6.1)	168
6.6.8.3	Additional Information on General Start Settings	169
6.6.8.4	DC Start (Menu Index 5.6.2)	170
6.6.8.5	Synchronous Motor Start (Menu Index 5.6.3)	170
6.6.9	Stop Settings (Menu Index 5.7)	171
6.6.9.1	Stop Settings Overview	171
6.6.9.2	Settings (Menu Index 5.7.1)	173
6.6.9.3	DC Injection (Menu Index 5.7.2)	173
6.6.9.4	Quick Stop (Menu Index 5.7.3)	174
6.6.9.5	AC Brake (Menu Index 5.7.4)	174
6.6.10	Speed Control (Menu Index 5.8)	175
6.6.10.1	Speed Control Overview	175
6.6.10.2	Speed Control Status (Menu Index 5.8.1)	177
6.6.10.3	Additional Information on Speed Control Status	179
6.6.10.4	Speed Controller (Menu Index 5.8.2)	179
6.6.10.5	Speed Limits and Monitor (Menu Index 5.8.3)	182
6.6.10.6	Speed Reference (Menu Index 5.8.4)	184

6.6.10.7	Reference Freeze Overview	187
6.6.10.8	Reference Freeze (Menu Index 5.8.5)	188
6.6.10.9	Speed Ramps (Menu Index 5.8.6)	190
6.6.10.10	Speed Feedback (Menu Index 5.8.7)	197
6.6.10.11	Speed Bypass Overview	198
6.6.10.12	Speed Bypass (Menu Index 5.8.8)	198
6.6.10.13	Load Drooping (Menu Index 5.8.9)	199
6.6.10.14	Auto Tuning (Menu Index 5.8.11)	201
6.6.11	Torque control (Menu Index 5.9)	203
6.6.11.1	Torque Control Overview	203
6.6.11.2	Torque Control Status (Menu Index 5.9.1)	205
6.6.11.3	Limits (Menu Index 5.9.2)	207
6.6.11.4	Torque Reference (Menu Index 5.9.3)	210
6.6.11.5	Additional Information on Torque Reference	213
6.6.12	Process Control (Menu Index 5.10)	213
6.6.12.1	Process Control Overview	213
6.6.12.2	Process Control Status (Menu Index 5.10.1)	214
6.6.12.3	General Settings (Menu Index 5.10.2)	215
6.6.12.4	Process Reference (Menu Index 5.10.3)	217
6.6.12.5	Additional Information on Process Reference	221
6.6.12.6	Feedback (Menu Index 5.10.4)	221
6.6.12.7	PID Controller (Menu Index 5.10.5)	224
6.6.12.8	Feedforward Controller (Menu Index 5.10.6)	226
6.6.12.9	Additional Information on Feedforward Controller	227
6.6.12.10	Auto Tuning (Menu Index 5.10.7)	227
6.6.13	Inching (Menu Index 5.11)	228
6.6.14	Mechanical Brake Control (Menu Index 5.12)	229
6.6.14.1	Mechanical Brake Control Overview	229
6.6.14.2	Mechanical Brake Control Status (Menu Index 5.12.1)	231
6.6.14.3	Mechanical Brake Control Status Word Descriptions	232
6.6.14.4	Brake Settings (Menu Index 5.12.2)	232
6.6.14.5	Additional Information on Brake Settings	235
6.6.15	Additional Status Outputs (Menu Index 5.26)	236
6.6.15.1	General Digital Outputs (Menu Index 5.26.1)	236
6.6.16	Fieldbus Process Data (Menu Index 5.27)	237
6.6.16.1	Fieldbus Process Data Status (Menu Index 5.27.1)	237
6.6.16.2	Additional Information on Fieldbus Process Data Status	239
6.6.17	Auxiliary Device Control (Menu Index 5.33)	239

6.7 Maintenance & Service (Menu Index 6)	239
6.7.1 Maintenance & Service Overview	239
6.7.2 Status (Menu Index 6.1)	240
6.7.2.1 Grid Status (Menu Index 1.1)	240
6.7.2.2 Power Conversion & DC Link Status (Menu Index 2.1)	241
6.7.2.3 Filters & Brake Chopper Status (Menu Index 3.1)	243
6.7.2.4 Motor Status (Menu Index 4.1)	243
6.7.2.5 Application Status (Menu Index 5.1)	247
6.7.2.6 Application Status Word Descriptions	248
6.7.2.7 Measured Temp. Protection Status (Menu Index 5.2.3.1)	251
6.7.2.8 Load Status (Menu Index 5.3.1)	252
6.7.2.9 Control Places Status (Menu Index 5.5.1)	252
6.7.2.10 Speed Control Status (Menu Index 5.8.1)	253
6.7.2.11 Additional Information on Speed Control Status	256
6.7.2.12 Torque Control Status (Menu Index 5.9.1)	256
6.7.2.13 Process Control Status (Menu Index 5.10.1)	257
6.7.2.14 Mechanical Brake Control Status (Menu Index 5.12.1)	258
6.7.2.15 Mechanical Brake Control Status Word Descriptions	259
6.7.2.16 Maintenance & Service (Menu Index 6.1.1)	259
6.7.3 Software Information (Menu Index 6.2)	260
6.7.4 Events (Menu Index 6.4)	260
6.7.4.1 Event Simulation (Menu Index 6.4.3)	260
6.7.4.2 Automatic Reset Function	262
6.7.4.3 Auto Reset (Menu Index 6.4.4)	262
6.7.5 Operational Counters (Menu Index 6.5)	263
6.8 Functional Safety (Menu Index 7)	265
6.8.1 Functional Safety Overview	265
6.8.2 Status (Menu Index 7.1)	265
6.8.3 Basic Settings	265
6.8.4 Safe Torque Off (STO)	265
6.8.5 STO (Menu Index 7.3)	266
6.8.6 Terminating STO and Resuming Normal Operation	266
6.8.7 SS1 SS2 (Menu Index 7.4)	266
6.9 Customization (Menu Index 8)	267
6.9.1 Customization Overview	267
6.9.2 Basic Settings (Menu Index 8.2)	267
6.9.3 Control Panel (Menu Index 8.3)	268

6.9.3.1	Readout Screen 1 (Menu Index 8.3.1)	268
6.9.3.2	Readout Screen 2 (Menu Index 8.3.2)	274
6.10	I/O (Menu Index 9)	280
6.10.1	I/O Overview	280
6.10.2	Basic I/O	280
6.10.2.1	I/O Status (Menu Index 9.3)	280
6.10.2.2	I/O Status Bits	281
6.10.2.3	Digital Inputs/Outputs (Menu Index 9.4)	282
6.10.2.4	Analog Inputs/Outputs (Menu Index 9.5)	296
6.11	Connectivity (Menu Index 10)	301
6.11.1	Connectivity Overview	301
6.11.2	Communication interfaces (Menu Index 10.2)	302
6.11.2.1	Host Settings (Menu Index 10.2.1)	302
6.11.2.2	Ethernet Interface X0 (Menu Index 10.2.2)	302
6.11.2.3	Ethernet Interface X1/X2 Settings (Menu Index 10.2.3)	303
6.11.2.4	Ethernet port X0 (Menu Index 10.2.4)	303
6.11.2.5	Ethernet port X1 (Menu Index 10.2.5)	304
6.11.2.6	Ethernet port X2 (Menu Index 10.2.6)	304
6.11.3	Protocols (Menu Index 10.3)	305
6.11.3.1	General Settings (Menu Index 10.3.1)	305
6.11.3.2	PROFINET (Menu Index 10.3.2)	307
6.11.3.3	Modbus TCP (Menu Index 10.3.3)	308

7 Troubleshooting

7.1	Viewing Warnings	310
7.2	Viewing and Resetting Faults	310
7.3	Reading the Event Summary Table	311
7.4	Events Summary for Industry Application Software	311

1 Introduction to the Application Guide

1.1 Version History

This guide is regularly reviewed and updated. All suggestions for improvement are welcome.

The original language of this guide is in English.

Version	Remarks	Software Version
M00104, document version 05	General Release 2	4.0.4

1.2 Purpose of this Application Guide

This application guide is intended for qualified personnel such as:

- Automation engineers
- Commissioning engineers who have experience operating with parameters and basic knowledge of AC drives

The application guide provides information on the initial configuration of the drive. The purpose of the guide is to provide information on parameters for configuring and controlling the drive, an overview and procedures of the various user interfaces in iC7, typical application examples, and troubleshooting of events in the drive.

1.3 Additional Resources

Additional resources are available with related information.



iC7-Automation Frequency Converters Design Guide provides information about the capability and functionality to design motor control systems for Danfoss iC7 series.

iC7 Series Frequency Converters Installation Safety Guide provides important safety information related to iC7 drives.



iC7-Automation Frequency Converters Installation Guides cover the mechanical and electrical installation of drives.

1.4 Safety Symbols

The following symbols are used in Danfoss documentation.

 DANGER
Indicates a hazardous situation which, if not avoided, will result in death or serious injury.
 WARNING
Indicates a hazardous situation which, if not avoided, could result in death or serious injury.
 CAUTION
Indicates a hazardous situation which, if not avoided, could result in minor or moderate injury.
NOTICE
Indicates information considered important, but not hazard-related (for example, messages relating to property damage).

The guide also includes ISO warning symbols related to hot surfaces and burn hazard, high voltage and electrical shock, and referring to the instructions.

	ISO warning symbol for hot surfaces and burn hazard
	ISO warning symbol for high voltage and electrical shock
	ISO action symbol for referring to the instructions

2 Industry Application Software Overview

2.1 Industry Application Overview

The iC7-Automation is delivered with the Industry application software as standard. The Industry application software offers a wide range of features supporting a large selection of generic applications. The features are briefly described in the following sections.

2.2 Basic Functions

2.2.1 I/O Control and Readouts

Depending on the hardware configuration of the drive, digital and analog inputs as well as digital, analog, and relay outputs are available. The I/Os can be configured and used to control the application from the drive.

If functional extension options are installed in the drive, the relevant parameters and I/O selections are automatically visible in the parameter structure.

2.2.2 Reference Handling

References from multiple sources can be defined, depending on the needs of the application.

Reference sources are:

- Analog inputs
- Digital inputs either as pulse input or digital potentiometer
- Reference from a fieldbus
- Up to 8 preset references (selectable by parameter, fieldbus, or digital inputs)
- Local reference from control panel

Reference signals can be added, subtracted, and multiplied, generating the reference to the drive. The final reference is scaled from -100% to 100%.

2.2.3 Ramps

Linear and S-ramps are supported. Linear ramps provide a constant acceleration and deceleration. S-ramps provide a non-linear acceleration and deceleration, with a soft transition at the start and end of the acceleration and deceleration process.

2.2.4 Quick Stop

In some situations, it may be required to stop the application quickly. For this purpose, the drive supports a specific deceleration ramp time from the synchronous motor speed to 0 RPM.

2.2.5 Limit Rotation Direction

The motor can be preset to run in one rotational direction only (positive or negative), avoiding unintended rotation direction.

2.2.6 Inching with Jogging Modes

Predefined speed settings are available for use during commissioning, maintenance, or service. The settings include Slow Down mode (operating at decreased speed), Jogging mode (operating at a preset speed), and Override mode (this mode overrides any reference settings).

2.2.7 Speed Bypass

Specific motor speeds can be bypassed during operation. The feature helps to minimize or avoid mechanical resonance of the machine, limiting the vibration and noise of the system.

2.2.8 Flying Start

Flying start enables the drive to synchronize to a freely spinning motor, before taking control of the motor. Taking over control of the motor at the actual speed minimizes mechanical stress to the system. This feature is relevant in fan and centrifuge applications, for example.

2.2.9 Mains Dropout

If there is a mains dropout and the drive cannot continue operation, it is possible to select predefined corrective actions. These actions include a trip, coasting, or performing a controlled ramp down.

2.2.10 Kinetic Backup

Kinetic backup enables the drive to remain in control if there is sufficient energy in the system, as inertia or when lowering a load, for example. The function allows a controlled stop of the machine.

2.2.11 Resonance Damping

High-frequency motor resonance noise can be eliminated by using resonance damping. Both automatic and manually selected frequency damping is available.

2.2.12 Motor Preheating

In cold and damp environments, the motor must be preheated to avoid condensation and cold starts. The feature DC Start generates a small DC current through the motor windings, keeping the temperature above the surrounding temperature.

2.2.13 Mechanical Brake Control

In applications like cranes, lifts and hoists, or downhill conveyors, a mechanical brake is used to keep the load at standstill when the motor is not controlled by the drive or when power is turned off.

The mechanical brake control feature ensures a smooth transition between the mechanical brake and the motor holding the load, by controlling the activation and deactivation of the mechanical brake.

2.2.14 Load Drooping

The load drooping function ensures that multiple motors, each controlled by a drive and connected to a common mechanical shaft, share the load. The function is typically used in cranes, winches, or larger conveyor systems controlled by 2 or more motors.

2.3 Controllers

2.3.1 Speed Controller

A built-in speed PID controller provides accurate control of the rotational speed of the motor. The controller offers control in both open and closed-loop configuration.

Open-loop mode does not require an external sensor for measuring the feedback signal. This allows easy installation and commissioning and eliminates the risk of defective sensors.

In closed-loop mode, a speed sensor is added, offering highly accurate control.

The parameters of the speed controller can be optimized by the built-in **auto tuning** function.

2.3.2 Torque Controller

A built-in torque controller provides optimized control of torque. Typical use cases are in tension control for winches or extruders. The drive offers both open-loop control where the current sensors provide the feedback and a closed-loop control with feedback provided by an external torque sensor.

2.3.3 Process Control

The process controller can control a process in a system where a constant pressure, flow, or temperature is needed, for example. Feedback from the application is connected to the drive, providing the actual process value. By controlling the motor speed, the controller ensures that the output matches the reference provided. The reference source and the feedback signals are converted and scaled to the actual values controlled. The controller provides full PID control, which includes PID parameter configuration, and is optimized by the built-in auto-tuning function.

2.4 Motor Control Features

2.4.1 Motor Types

The drive supports standard available motors, such as:

- Asynchronous motors
- Permanent magnet motors

2.4.2 Torque Characteristics

Different load characteristics are supported to match the actual application needs:

- **Variable torque:** Typical load characteristic of fans and centrifugal pumps, where the load is proportional to the square of the speed.
- **Constant torque:** Load characteristic used in machinery where torque is needed across the full speed range. Typical applications are conveyors, extruders, decanters, compressors, and winches.

2.4.3 Motor Control Principles

Different control principles can be selected to control the motor, matching the needs of the application:

- U/f control for simple open-loop operation.
- VVC+ (Voltage Vector Control) in both open and closed loop, for general-purpose application needs.
- FVC+ (Flux Vector Control) in both open and closed loop, for demanding application needs.

2.4.4 Motor Nameplate Data

Typical motor data for the drive are preset at the factory. The preset data allow operation of most motors. During commissioning, actual motor data are entered in the settings of the drive to optimize motor control.

2.4.5 Automatic Motor Adaptation (AMA)

Automatic Motor Adaptation (AMA) optimizes motor parameters for improved shaft performance. Based on motor product label data and measurements of the motor at standstill, key motor parameters are recalculated, and used to fine-tune the motor control algorithm.

2.4.6 Automation Energy Optimization (AEO)

The Automatic Energy Optimization (AEO) feature optimizes control with focus on lowering energy consumption at the actual load point.

2.5 Braking of Load

2.5.1 Overview of Braking of Load

For controlled load braking performed by the drive, various functions can be used. The specific function is selected based on the application and how fast the load has to be stopped.

2.5.2 Resistor Braking

In applications that require fast or continuous braking, a drive fitted with a brake chopper is typically used. Excess energy, generated by the motor during the braking of the application, is dissipated in a connected brake resistor. Braking performance depends on the specific drive rating and the selected brake resistor.

2.5.3 Overvoltage Control (OVC)

If braking time is not critical or the load is varying, the overvoltage control (OVC) feature can be used to control the stopping of the application. The drive extends the ramp-down time when it is not possible to brake within the defined ramp-down period. This feature must not be used in hoisting applications, high inertia systems, or applications where continuous braking is required.

2.5.4 DC Brake

When braking at low speed, the braking of the motor can be improved by using the DC brake feature. The software offers configurable DC-braking for induction motor control. It injects a user-defined DC current.

2.5.5 AC Brake

In applications where the operation of the motor is non-cyclic, AC braking can be used to shorten the braking time. Excess energy is dissipated by increasing losses in the motor during braking. Performance is motor type dependent and offers best performance on asynchronous motors.

2.5.6 DC Hold

The software offers the possibility to configure the feature DC Start for DC holding before entering normal motor control.

2.5.7 Load Sharing

In some applications, 2 or more drives control the application at the same time. If 1 of the drives is braking a motor, the excess energy can be fed to the DC link of a drive driving a motor, which results in a reduction of the total energy consumption. This feature is typically useful in, for example, decanters and carding machines, where smaller power-sized drives operate in generator mode.

2.6 Protection Features

2.6.1 Grid Protection

The drive protects against conditions in the power grid that can affect proper operation. The grid is monitored for phase imbalance and phase loss. When the imbalance exceeds specified limits, the drive issues a configurable response and corrective actions can be taken.

The supply frequency is also monitored, and when the drive is outside acceptable limits, it reacts in the configured way. Furthermore, the software of the drive offers optional protection against undervoltage and a configurable response to grid spikes.

2.6.2 Drive Protection Features

The drive is monitored and protected during operation.

Inbuilt temperature sensors measure the actual temperature and provide relevant information to protect the drive. If the temperature exceeds its nominal temperature conditions, derating of operational parameters is applied. If the temperature is outside the allowed operating range, the drive stops operation.

The motor current is continuously monitored on all 3 phases. If there is a short circuit between 2 phases, or a fault to ground, the drive detects the short circuit and immediately turns off. If the output current is exceeding its nominal values during operation for longer periods than allowed, the overload capability is reduced until the conditions are restored.

The DC-link voltage of the drive is monitored. If it exceeds critical levels, the drive issues a warning. If the situation is not resolved, the drive stops operation.

2.6.3 Motor Protection Features

The drive provides various features to protect the motor and the application.

The output current measurement provides information to protect the motor. Overcurrent, short circuit, ground faults, and lost motor phase connections can be detected and relevant protections initiated.

Monitoring of speed, current, and torque limits provides an extra protection of the motor and the application. Under extreme load conditions, it also provides motor stall protection.

Locked-rotor protection secures that the drive is not starting with a blocked rotor of the motor.

Motor thermal protection is provided either as a calculation of the motor temperature based on the actual load, or by external temperature sensors connected to Temperature Measurement OC7T0. Supported sensor types are Pt100, Pt1000, Ni1000, KTY84, and KTY81.

2.6.4 Protection of External Filters or Brake Resistors

Brake resistors are monitored for thermal overload (by calculated thermal load or an external sensor), short circuit, and missing connections.

The drive can also monitor the temperature of externally connected filters.

2.6.5 Automatic Derating

Automatic derating of the drive allows continued operation even if the nominal operation conditions are exceeded. Typical factors affecting operation are temperature, high DC-link voltage, high motor load, or operation close to 0 Hz. Derating is typically applied as a reduction in switching frequency or change in switching pattern, resulting in lower thermal losses.

2.7 Monitoring, Logging, and History Log

2.7.1 Monitoring Features

The drive offers a wide range of monitoring features that provide information of actual operating conditions. Some examples are:

Speed monitoring

The motor speed can be monitored during operation. If the speed exceeds minimum or maximum limits, the user is notified and can initiate appropriate actions.

Temperature monitoring

Temperatures of the drive and external connected sensors can be monitored. This way you can monitor the operational conditions of the drive and the related application.

Grid monitoring

During operation, the drive is able to monitor the grid conditions. It measures the grid voltage for each supply phase and the grid frequency, and calculates the grid voltage imbalance and total harmonic distortion (THDv).

2.7.2 Event Log

An event log provides access to the latest registered warnings and faults, providing relevant information for analysis of the events that occur in the drive.

2.7.3 Logging and Storage of Data

Logging of operational data from the drive and the related process is possible during running. Logging can be continuous or triggered by specific events. Data is stored to the microSD card placed in the drive, or transferred directly to MyDrive Insight. This feature provides the opportunity to collect data for a detailed analysis of operation and the events happening during operation.

2.8 Functional Safety

A Safe Torque Off function with dual input is available as standard in the drive. An additional Safe Torque Off feedback signal indicates the status of the drive.

More functional safety features are available as optional selections. The set of features covers a wide range of functional safety functions that can operate in both sensorless and closed-loop setup. A safe fieldbus is also supported as option.

2.9 Software Tools

2.9.1 Overview of Software Tools

Danfoss offers a suite of desktop software tools which have been designed to provide easy operation and the highest level of customization of AC drives.

APIs and the Danfoss Device Interface make it possible to integrate the tools into proprietary systems and business processes. The MyDrive® tools support the entire life cycle of the drive, from system design to service. Some of the tools are available free of charge, and some require a subscription.

For more information about the MyDrive® tools, see MyDrive documentation.

2.9.2 MyDrive® Select

MyDrive® Select performs frequency converter sizing based on calculated motor load currents, ambient temperature, and current limitations. The sizing results are available in graphical and numerical format, and include calculations of efficiency, power losses, and inverter load currents. The resulting documentation is available in .pdf or .xls format, and can be imported to MyDrive® Harmonics for evaluation of the harmonic distortion, or validation of compliance towards most recognized harmonic norms and recommendations.

MyDrive® Select is available as a web-based tool at select.mydrive.danfoss.com and as a mobile device app that can be downloaded from app stores.

2.9.3 MyDrive® Harmonics

MyDrive® Harmonics estimates the benefits of adding harmonic mitigation solutions to an installation and calculates system harmonic distortion. The evaluation can be done both for new installations and when extending an existing installation.

The free version provides a fast overview of the expected general performance of the system. The expert version of MyDrive® Harmonics requires a subscription, which opens up more features, including the possibility to save and share harmonic projects, import projects from MyDrive® Select, and the possibility to add Danfoss harmonic mitigation products.

2.9.4 MyDrive® ecoSmart™

MyDrive® ecoSmart™ determines the energy efficiency of the drive being used and the system efficiency class according to IEC 61800-9.

MyDrive® ecoSmart™ uses information about the selected motor, load points, and AC drive to calculate the efficiency class and part load efficiency for a Danfoss AC drive, either for a free-standing drive (CDM), or a drive with a motor (PDS).

MyDrive® ecoSmart™ is available as a web-based tool at ecosmart.mydrive.danfoss.com and as a mobile device app that can be downloaded from app stores.

2.9.5 MyDrive® Insight

MyDrive® Insight is a software tool for commissioning, engineering, and monitoring drives. MyDrive® Insight can be used to configure parameters, upgrade software, and set up functional safety features and condition-based monitoring.

Making backups, restoring the system from a backup, and data logging within MyDrive® Insight support the use of a microSD card as storage device.

2.10 Security Features

NOTICE

Do not connect the drive directly to the internet, as end-to-end connectivity is not secured via Danfoss software tools. It is recommended that drives are installed by authorized and educated personnel, who are aware of the security risks in networks and can mitigate threats in the network. Typically, the drive can be accessed and configured by anyone with physical access.

The drive provides the following cybersecurity features:

- Secure boot chain
- Signed and encrypted firmware and application software
- Secure software updates
- License verification
- Secure connectivity for all communication interfaces

2.11 Motor Control Features for FVC+ and VVC+ Control

2.11.1 Compatibility of Motor Control Features for FVC+ and VVC+ Control

The following table outlines the compatibility of motor types and motor control related features with motor control principles.

Table 1: Motor Control Features and Motor Types

Motor type/Feature		Induction motors		Synchronous motors	
		FVC+	VVC+	FVC+	VVC+
Motor type	Induction motor (IM)	X	X	-	-
	Surface permanent magnet motor (SPM)	-	-	X	X
	Interior permanent magnet motor (IPM)	-	-	X	X
Speed feedback	Open loop	X	X	X	X
	Closed loop (with Encoder Resolver)	X	X	X	-

Table 1: Motor Control Features and Motor Types (continued)

Motor type/Feature		Induction motors		Synchronous motors	
		FVC+	VVC+	FVC+	VVC+
Reference handling	Speed control	X	X	X	X
	Torque control	X	-	X	-
	Linear ramp	X	X	X	X
	S-ramp	X	X	X	X
	Load drooping	X	X	X	X
	Windowing in torque control	X	-	X	-
Limit handling	Speed limit	X	X	X	X
	Torque limit	X	X	X	X
	Current limit	X	X	X	X
	Power limit	X	X	X	X
	Overvoltage control	X	X	X	X
	Undervoltage control	X	X	X	X
Auxiliary functions	Flying start	X	X	X	X
	Automatic energy optimization (AEO)	X	X	X	X
	Power loss action	X	X	X	X
	AC brake (Flux brake)	X	X	-	-
	Start magnetization	X	X	-	-
	DC brake	X	X	X	X
	DC-injection in stop	X	X	X	X
	Stop state magnetization	X	X	-	-
	Initial position detection	-	-	X	X
	Rotor parking	-	-	X	X

Table 1: Motor Control Features and Motor Types (continued)

Motor type/Feature		Induction motors		Synchronous motors	
		FVC+	VVC+	FVC+	VVC+
Commissioning functions	AMA standstill	X	X	X	X
	Inertia measurement	X	-	X	-
	Speed control auto-tuning	X	-	X	-
Filters	Sine filter	X	X	-	X
	Advanced harmonic filter	X	X	X	X
Process functionality and protections	Mechanical brake control in closed loop	X	-	X	-
	Missing motor phase	X	X	X	X
	Motor thermal protection	X	X	X	X
	Electronic thermal relay (ETR)	X	X	X	X

2.11.2 High Frequency Voltage Injection

For salient pole synchronous motors under FVC+, High Frequency Voltage Injection (HFVI) is an encoder/resolver alternative for rotor position detection at low speeds. If the motor has sufficient saliency (typically larger than 1.1), HFVI allows applications to run open loop with performance like closed loop.

In a salient pole motor, the magnetic material of the rotor is not rotationally symmetric, as opposed to a non-salient pole motor where it is. That means that the magnetic path through different diameters of the rotor varies. This variation results in different values of L_q and L_d inductances, which can be used to determine the orientation of the rotor. The saliency ratio is the ratio between L_q and L_d .

Commissioning HFVI

A typical HFVI commissioning workflow is:

1. Set **4.3.1.1 Motor Control Principle** to FVC+.
2. Enter the product label data to **4.2.4 Permanent Magnet Motor** and set **4.2.1.1 Motor Type**.
3. Run full AMA: Set **4.2.1.4 Ama Mode** to Motor Data and start the drive.
4. Enable HFVI by setting **4.3.3.4 Low Speed Mode**.

While HFVI is enabled, the saliency ratio is validated.

Table 2: Saliency ratios

Saliency ratio (Lq/Ld)	Drive response
SR ≤ 1.1	Motor start prevented.
1.1 < SR < 1.5	Warning issued in the event log. Tracking capabilities are possibly reduced.

HFVI parameters

The setup parameters are all located under **4.3.3 FVC+ Settings** in the **4.3 Motor Control** menu. HFVI is enabled by setting **4.3.3.4 Low Speed Mode** (1 in the following picture) to HF Injection.

①	4.3.3.4	Low Speed Mode	Normal Motor Control	Normal Motor Control	0	3	
	4.3.3.5	I/f Control Current %	100	100	0	500	%
	4.3.3.6	I/f Control Threshold Speed	10	300	1	50	rpm
	4.3.3.7	Low Speed Minimum Current	50	50	0	100	%
	4.3.3.8	Minimum Current Threshold Speed	10	10	1	50	Hz
	4.3.3.9	Motor Feedback Mode	Open Loop	Open Loop	0	1	
②	4.3.3.10	HF Inject Voltage Gain %	100	100	5	2000	%
③	4.3.3.11	HF Inject Bandwidth %	100	100	1	1000	%
④	4.3.3.12	HF Inject Angle Comp Gain	0	0	-35	35	°
⑤	4.3.3.13	HF Inject Angle Comp Offset	0	0	-25	25	°
⑥	4.3.3.14	HF Inject Frequency	0	0	0	3.4028234663852886e+38	Hz
⑦	4.3.3.15	Idlq Reference Ratio Pct	0	0	-100	100	%

Figure 1: HFVI parameters

The basic settings are done with the following 3 parameters:

- **4.3.3.10 HF Inject Voltage Gain % (2):** Set the magnitude of the injected voltage as a percentage of the recommended injected voltage.
- **4.3.3.11 HF Inject Bandwidth % (3):** Set the bandwidth of the position estimation as a percentage of the recommended bandwidth.
- **4.3.3.14 HF Inject Frequency (6):** This is an optional parameter to force the injection frequency to a specific value. If set to 0, the recommended injection frequency is used.

The recommended injected voltage and frequency are calculated based on motor data.

To ensure sufficient saliency levels under all load conditions, more advanced settings can be set with these 3 parameters:

- **4.3.3.12 HF Inject Angle Comp Gain (4):** Load-dependent offset to the estimated rotor angle.
- **4.3.3.13 HF Inject Angle Comp Offset (5):** Offset to the estimated rotor angle.
- **4.3.3.15 Idlq Reference Ratio Pct (7):** Disables the existing magnetization current controlling scheme, like MTPA, and introduces a magnetization current as a percentage of the torque current. This parameter can be used to force the motor to run with elevated magnetization current levels, if it is required to ensure sufficient saliency levels.

These 3 parameters require detailed information about the motor flux at various operating conditions.

2.12 PROFIdrive - Standard Telegram 1

2.12.1 Overview of PROFIdrive - Standard Telegram 1

Standard telegram 1 is implemented according to PROFIdrive Application Class 1 profile as defined in the PROFIdrive standard and state machine diagram.

2.12.2 Control Word (CTW) in PROFIdrive Standard Telegram 1

Table 3: Control Word Bits in PROFIdrive Standard Telegram 1

Bit number	Name	Description
0	On-Off	1 = On. 0 = Off.
1	Coast stop	1 = No coast stop. 0 = Coast stop.
2	Quick stop	1 = No quick stop. 0 = Quick stop.
3	Operation	1 = Enable operation. 0 = Disable operation.
4	Ramp generator	1 = Enable ramp generator (RFG). 0 = Reset ramp generator. Output of the RFG is set to 0. The drive decelerates along the current limit or along the voltage limit of the DC link.
5	Freeze	1 = Unfreeze ramp generator. 0 = Freeze ramp generator. Freezes the present output frequency (in Hz).
6	Enable setpoint	1 = Enable setpoint. 0 = Disable setpoint.
7	Fault acknowledge	0 ⇒ 1 = Acknowledge faults. Acknowledging is edge triggered, when changing from logic 0 to logic 1. 0 = No function.
8	Jog 1	1 = Jog 1 on. 0 = Jog 1 off. Operation is enabled, drive is at standstill, and STW1 bit 4, 5, 6 = 0. The drive runs up along the ramp to jogging setpoint 1.
9	Jog 2	1 = Jog 2 on. 0 = Jog 2 off. Operation is enabled, drive is at standstill, and STW1 bit 4, 5, 6 = 0. The drive runs up along the ramp to jogging setpoint 2.
10	Control by PLC	1 = Uses process data (control by PLC). 0 = Ignores the current process data. This is linked to a submodule where the CTW is present. If signals are to be covered, the CTW/STW profile (for example, the iC Speed Profile) must be part of the signals list.

Table 3: Control Word Bits in PROFIdrive Standard Telegram 1 (continued)

Bit number	Name	Description
11	Reserved	Reserved for future use.
12	User defined	These bits enable the mapping of application functionality of the drive to the control word. Mapping is done through parameters. For more information, refer to the Parameter Descriptions chapter in the application guide.
13	User defined	
14	User defined	
15	User defined	

2.12.3 Status Word (STW) in PROFIdrive Standard Telegram 1

Table 4: Status Word Bits in PROFIdrive Standard Telegram 1

Bit number	Name	Description
0	Ready to switch on	1 = Ready to switch on. 0 = Not ready to switch on.
1	Ready to operate	1 = Ready to operate. 0 = Not ready to operate.
2	Operation enabled	1 = Operation enabled. 0 = Operation disabled.
3	Operation fault	1 = Fault present. 0 = No fault.
4	Coast stop	1 = Coast stop not activated (No OFF2). 0 = Coast stop activated (OFF2).
5	Quick stop	1 = Quick stop not activated (No OFF3). 0 = Quick stop activated (OFF3).
6	Switching on inhibited	1 = Switching on inhibited. 0 = Switching on not inhibited.
7	Warning	0 = A warning has occurred. 0 = There are no warnings.
8	Speed=reference/Speed<>reference	1 = The current motor speed matches the current speed reference within a given tolerance. The tolerance is product specific. The motor runs, but the current speed is different from the current speed reference. This can happen, for example, when the speed ramps up or down during start or stop.

Table 4: Status Word Bits in PROFIdrive Standard Telegram 1 (continued)

Bit number	Name	Description
9	Bus control/Local operation	1 = The device is controlled and reacting to I/O and process data. 0 = The device does not react on commands from fieldbus, because of one of the following reasons: <ul style="list-style-type: none"> • CTW bit 10 = 0. • HMI is in local mode. • MyDrive® Insight has taken control. • Control places do not include fieldbus.
10	Frequency limit ok/Out of frequency limit	1 = The output frequency is within the defined motor limits. 0 = The output frequency has exceeded the defined motor limits given by parameters. The speed limits are set by these parameters: <ul style="list-style-type: none"> • P 5.8.3.4 High Speed Warning • P 5.8.3.9 Low Speed Monitor Limit
11	User defined	These bits enable the mapping of application functionality of the drive to the status word. Mapping is done through parameters. For more information, refer to the Parameter Descriptions chapter in the application guide.
12	User defined	
13	User defined	
14	User defined	
15	User defined	

2.12.4 PROFIdrive State Machine

In the PROFIdrive control profile, the control bits perform different functions:

- 0–3 perform the basic startup and power-down functions.
- 4–10 perform application-oriented control.
- 12–15 can be configured for different purposes.

See [Figure 2](#) for the basic state transition diagram, where control bits 0–3 control the transitions and the corresponding status bit indicates the actual state. The black dots indicate the priority of the control signals. Fewer dots indicate lower priority, and more dots indicate higher priority.

The general state diagram is defined in the PROFIdrive standard.

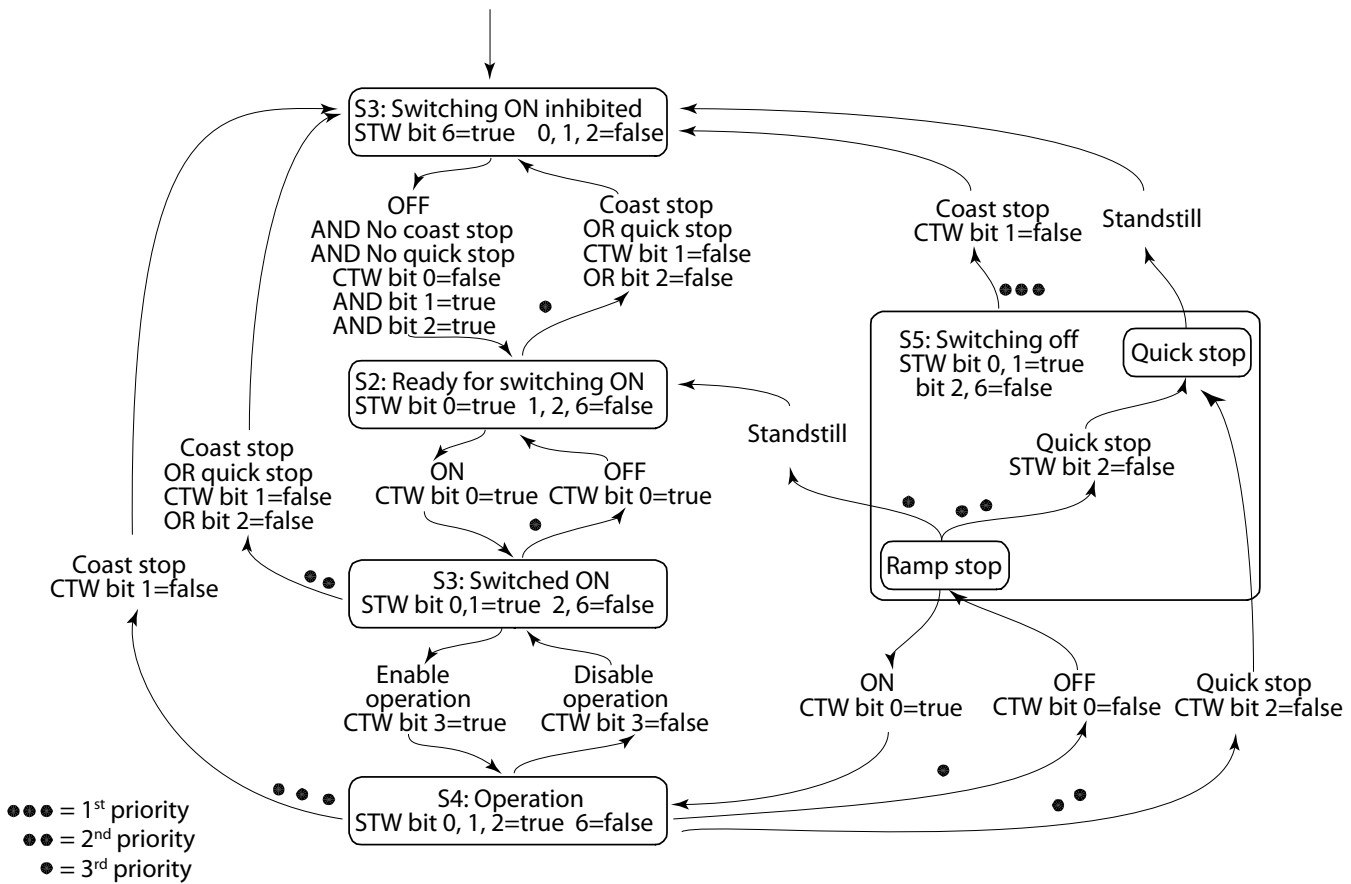

Figure 2: General State Diagram

2.13 iC Speed Profile

2.13.1 Overview of iC Speed Profile

The iC speed profile is used with the iC7 series. The iC speed profile differs from the PROFIdrive profile, because it does not have a State Machine. It is only controlled by the actual state 1/0 of the control bits, not the sequence in which they are manipulated.

2.13.2 Control Word (CTW) in iC Speed Profile

Table 5: iC Speed Profile Control Word Bits

Bit number	Name	Description
0+1	Preset reference selector	00 = Preset reference 1 01 = Preset reference 2 10 = Preset reference 3 11 = Preset reference 4
2	Reserved	Reserved for future use. Any control words sent to the device should keep this bit at 0 to ensure compatibility with future extensions of the control word.
3	Coast	1 = No function. 0 = Cause the frequency converter to immediately coast the motor.

Table 5: iC Speed Profile Control Word Bits (continued)

Bit number	Name	Description
4	Quick Stop	1 = No function. 0 = Quick stop the frequency converter and ramp down the motor speed to stop as defined with the quick stop ramp parameter.
5	Hold output frequency.	1 = No function. 0 = Hold the present output frequency (in Hz).
6	Start	1 = If the other starting conditions are fulfilled, this selection allows the frequency converter to start the motor. 0 = Stop the frequency converter and ramps down the motor speed as defined with the ramp down parameter.
7	Fault acknowledge	0 ⇒ 1 = Acknowledge faults. Acknowledge is edge-triggered, when the logic is changed from 0 to 1. Faults can only be acknowledged is the triggering condition has been removed and any required acknowledgment has been done. 0 = No function.
8	Jog	1 = Set the output frequency to the jog speed defined with the jog speed parameter. 0 = No function.
9	Ramp select	1 = Ramp 2 is active. 0 = Ramp 1 is active.
10	Data valid	1 = Use process data (control by PLC). 0 = Ignore the current process data. This is linked to the submodule where the CTW is present. If signals are to be covered, the CTW/STW profile (the iC Speed Profile for example) must be part of the signals list. Use the previously processed data when the data valid bit was true (no control by PLC).
11	Reserved	Reserved for future use.
12	User defined	These bits are reserved for application-specific advanced control. For more information, refer to the Parameter Descriptions chapter in the application guide.
13	User defined	
14	User defined	
15	User defined	

2.13.3 Status Word (STW) in iC Speed Profile

Table 6: iC Speed Profile Status Word Bits

Bit number	Name	Description
0	Control ready	1 = The device controls are ready and react to process data. 0 = The device controls are not ready and do not react to process data.
1	Frequency converter ready	1 = The frequency converter is ready for operation. 0 = The frequency converter is not ready for operation. This status does not involve faults and warnings as they are indicated in their respective bits elsewhere.
2	Coast	1 = There are no active coast signals, and the motor can start when a start signal is given. 0 = The frequency converter has an active coast signal and has released the motor.
3	Fault	1 = A fault has occurred, and an acknowledge signal is required to re-establish operation. 0 = There are no faults.
4	Reserved	Reserved.
5	Reserved	Reserved.
6	Reserved	Reserved.
7	Warning	1 = A warning is active. 0 = There are no warnings.
8	Speed=reference	1 = The current motor speed matches the current speed reference within a given tolerance. The tolerance is product specific. 0 = The motor runs, but the current speed is different from the current speed reference, for example while the speed ramps up or down during start or stop.
9	Bus control/Local operation	1 = The device is controlled and reacting to I/O and process data. 0 = The device does not react on commands from the fieldbus, for 1 of the following reasons: <ul style="list-style-type: none"> • CTW bit 10 = 0. • HMI is in local mode. • MyDrive® Insight has taken control. • Control places do not include fieldbus.
10	Frequency limit	1 = The output frequency is within the defined motor limits. 0 = The output frequency has exceeded the defined motor limits. The speed limits are set with the parameters: <ul style="list-style-type: none"> • P 5.8.3.1 Positive Speed Limit • P 5.8.3.2 Negative Speed Limit • P 5.8.3.3 Minimum Speed Limit

Table 6: iC Speed Profile Status Word Bits (*continued*)

Bit number	Name	Description
11	Operation	1 = The process is running, and the motor can be running or start at any time. 0 = There are no active start requests, and the process does not run. The motor is coasted and is not started.
12	Reserved	Reserved.
13	Reserved	Reserved.
14	User defined	These bits are reserved for application-specific advanced control. For more information, refer to the Parameter Descriptions chapter in the application guide.
15	User defined	

3 User Interfaces

3.1 Overview of User Interfaces

To interact with a Danfoss iC7 Series drive, use either the control panel as a simple and direct interface, or the software tool MyDrive® Insight for more advanced interaction with the drive. The control panel can be mounted directly on the drive, or close to the drive by using a control panel mounting kit.

With MyDrive® Insight the drive can be accessed from a remote place, if the infrastructure is in place and the network provides the required access rights.

3.2 Control Panel

3.2.1 iC7 Control Panel Options

The iC7 series offers a broad range of interfaces which suit different connectivity requirements to support wireless regulations.

The iC7 Series offers the following 2 different control panel options. Refer to the relevant Design Guide for information on which control panels are available to your product.

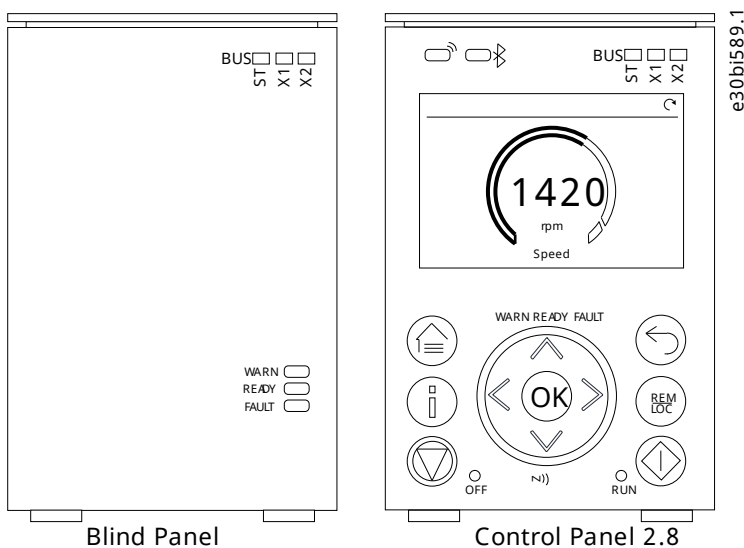

Figure 3: Control Panel Options

- **Blind Panel OPX00:** This panel shows the basic status of the drive and fieldbus indicators. The panel is typically used when only limited interaction with the drive is required after installation and commissioning, or when the drives are controlled by fieldbus.
- **Control Panel 2.8 OPX20:** This panel is the standard user interface, and used when frequent interaction with the drive is required. The panel enables easy setup of the drive via parameters, monitoring the drive status, and also shows event notifications.

Control Panel 2.8 OPX20 has the following features:

- 2.8" monochromatic user interface with a display resolution of 240 x 160 pixels.
- Visual LEDs to illustrate drive status and fieldbus communication.
- Halo indicator with 3 colors to illustrate drive status at a glance.
- A display which can be customized to show required or essential information.
- Buttons to control the drive locally, including a toggle button to easily switch between local and remote control.
- Parameter widgets which support alphanumeric and special characters, integers, floating points, date time formats, choice lists, and commands to configure application data.
- Help texts to support operation.

3.2.2 Control Panel Elements

The control panel provides an interface for configuring and controlling the converter easily. The section describes the elements for all control panel options.

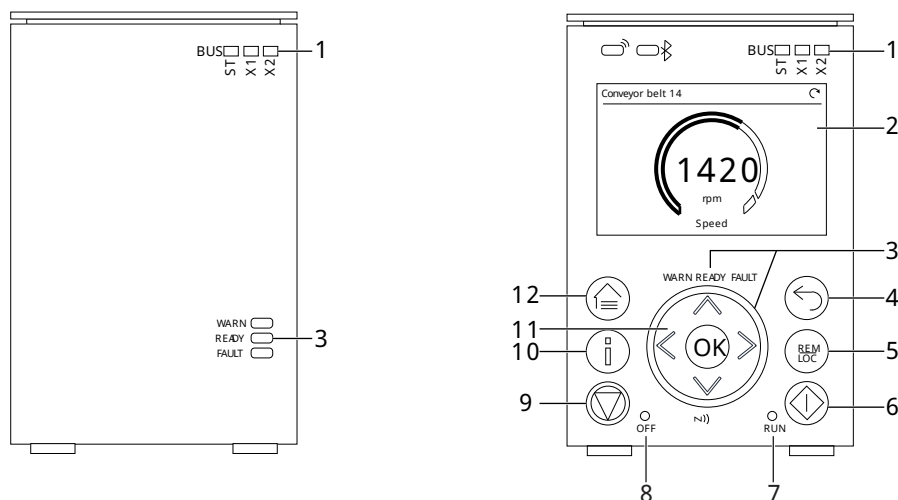

e30bj769.1:

Figure 4: Control Panel Elements

The following table describes the control panel elements:

Table 7: Control Panel Elements Description

Legend	Name of Element	Description
1	Fieldbus Indicators	<p>The LEDs indicate the status of the communication interface X1 and X2.</p> <ul style="list-style-type: none"> • [ST] <ul style="list-style-type: none"> - Green blinking LED indicates that the communication interfaces are in normal operating state. - Red blinking LED indicates that an error has occurred and communication is not possible. • [X1] <ul style="list-style-type: none"> - Green blinking LED indicates data exchange on communication interface X1. - Red blinking LED indicates an error during data exchange on communication interface X1. • [X2] <ul style="list-style-type: none"> - Green blinking LED indicates data exchange on communication interface X2. - Red blinking LED indicates an error during data exchange on communication interface X2.
2	Display	<p>Enables access to content and settings. The display provides detailed information about the status of the converter.</p>

Table 7: Control Panel Elements Description (continued)

Legend	Name of Element	Description
3	Converter Status Indicators	<p>The LEDs indicate the status of the converter.</p> <ul style="list-style-type: none"> • [WARN] <ul style="list-style-type: none"> - When this text is lit in yellow, it indicates a warning-level event. • [READY] <ul style="list-style-type: none"> - When this text is lit in white, it indicates that the converter is ready for operation. - When this text is blinking white (1 Hz), it indicates that the converter is powered on but is not ready. • [FAULT] <ul style="list-style-type: none"> - When this text is lit in red, it indicates a fault. <p>The status of the converter is also indicated by the Halo, which has the same color indicators as the converter status texts on the control panel.</p>
4	Back button	Navigates to the previously viewed screen or a menu level above the current menu.
5	REM/LOC	Toggles the converter between remote and local operation.
6	Run button	Starts the operation of the converter.
7	RUN LED	<p>The indicator has the following states:</p> <ul style="list-style-type: none"> • On: Start command is applied and the converter is modulating. • Off: The converter has stopped and the start command is not applied.
8	OFF LED	<p>The indicator has the following states:</p> <ul style="list-style-type: none"> • Steadily on: The indicator is in this state because of either of the following 2 reasons: <ul style="list-style-type: none"> - The converter is not modulating and is coasted. - The stop signal is applied, output is active, and the converter is ramping down until coast or restart. Ramp times, protections, and stopping functions prolong this state. • Flashes for 3 seconds: Indicates that the start command is initiated, but the converter is not able to start. • Off: The converter is in operation, a start signal is applied, and the output is active. This also includes ramping, running on reference, and AMA. <p>Note: When a fault has occurred in the converter, the LED is on though the start command is available. If there is a fault event, and the start command is disabled and reinitiated again, the Off LED blinks.</p>
9	Stop button	Stops the operation of the converter.
10	Info button	Provides more detailed information about an event that has occurred in the converter. Pressing Info also shows a context sensitive help for parameters.
11	Arrow buttons	<ul style="list-style-type: none"> • Arrow buttons: Used to navigate within the different screens and menus. • [OK]: Primarily used to confirm selections and data in the control panel display.
12	Home/Menu button	Toggles between Home screen and the current parameter menu, to allow quick access to key status information during parameter setup.

3.2.3 Control Panel Basic Configurations

The basic configurations of the control panel include:

- A readout of the status of the motor and the drive, including warnings and faults.
- Navigable menus, where the parameter settings of the drive can be viewed and changed.

3.2.4 Starting the Drive and Control Panel Display

While the drive is powering up until it is ready to operate, the control panel display shows the following:

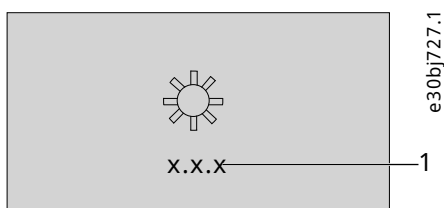

Figure 5: Control Panel Display on Startup

- 1 The software version

NOTICE

When the drive is started, it takes 25–30 s for the drive to be in ready state and for the control panel display to change to the Home screen (default).

3.2.5 Understanding Readout Screens

When the drive is in ready state, the control panel display shows the *Home* screen. By default, the *Homescreen* is shown as follows.

The *Home* screen can be customized.

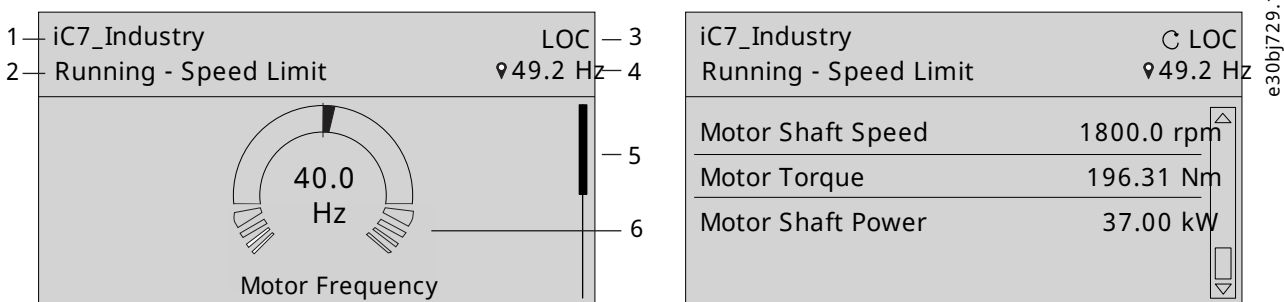

Figure 6: Home Screen (Donut View vs. Line View)

1	The name of the application software.	2	The status of the drive (see the following table).
3	The current control of the drive. REM indicates remote control and LOC indicates local control. The arrow shows the direction of the motor.	4	The setpoint of the selected operation mode. The local setpoint can only be changed when the drive is in local control.
5	The scroll bar. The scroll bar indicates whether the screen is in the upper <i>Readout Screen 1</i> or lower <i>Readout Screen 2</i> position, when in the menu structure or parameters.	6	The readout value as a donut infographic view. It is possible to show only a single readout in a donut view. When more than 1 readout is configured, the screen changes to a line view. A minimum of 2 and a maximum of 5 readouts are shown in the line view.

The status line of the control panel shows the status of the drive. The status line texts are dynamically generated, based on the configuration of the system. The following are some examples of basic operation:

Table 8: Drive Status Texts

Drive status in the panel	Description
Drive Ready	The drive is powered and ready to start.
Running at Reference	The drive is running at the selected reference.
Running at Standstill	The drive is running with 0 reference.
Stopping	The drive is running towards stop.
Stopped	The drive is stopped due to an active stop command.
Coasted	The drive is coasting due to an active coast command.
Quick Stop	The drive is stopped due to an active quick stop command.
Start Interlock	The drive is stopped with an active start command. To restart, the start command must be removed and given again.
Start Inhibited	The drive is in a state that is preventing start. All start commands are ignored.
Safe Torque Off (STO)	The drive is coasting due to an active STO command.
Inching	The drive is inching or jogging.
Running/Stopping/Inching with: <ul style="list-style-type: none"> • Power Limit • Undervoltage Limit • Overvoltage Limit • Torque Limit • Current Limit • Speed Limit 	The drive is running, stopping, or inching, and has exceeded the limit that is shown. For example, <i>Running - Power Limit</i> . Some possible limits are listed in the cell on the left. See also the preceding image.
AMA Ready	Advanced Motor Adaptation is activated and is waiting for the start command.
AMA in Progress	Advanced Motor Adaptation is running, measuring motor data.
AMA Finished	Advanced Motor Adaptation is finished. To restart the drive, remove and then reapply the start command.

Press the down arrow on the control panel when in *Readout Screen 1*, and the control panel screen navigates to *Readout Screen 2*. As a factory default setting, the control panel shows 3 readout values, as shown in the preceding image.

3.2.6 Adjusting Display Backlight and Contrast

When in *Readout Screen 1* or *Readout Screen 2*, it is possible to adjust the backlight intensity and contrast of the display.

To adjust the display backlight and contrast settings, press the Info button and any of the arrow buttons of the control panel. The settings are shown on the screen:

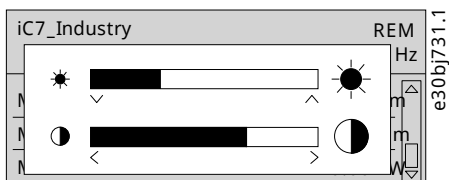

Figure 7: Intensity Change in Backlight and Contrast

- To change the intensity of the backlight, keep pressing the Info button along with either the up and down arrow buttons of the control panel.
- To change the contrast, keep pressing the Info button along with either the left and right arrow buttons of the control panel.

3.2.7 Changing the Content of the Readout Screens

This chapter outlines an example procedure for changing or customizing the content of *Readout Screen 1*. The same procedure is applicable for *Readout Screen 2*.

1. To start the screen content editing mode, press OK for a minimum of 5 seconds. The screen changes as shown in the following image.

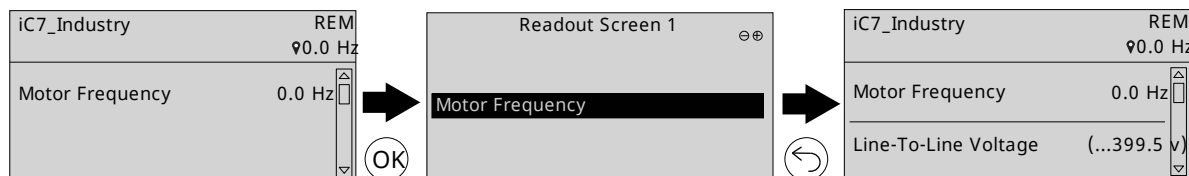

Figure 8: Typical Readout Screen

2. Remove an existing readout by pressing the up arrow button on the control panel and navigating to the *Remove readout* button on the UI and pressing it.

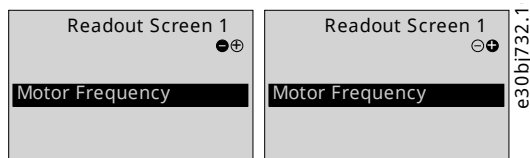

Figure 9: Add Readout and Remove Readout Buttons

NOTICE

When the remove readout button is pressed, the last readout on the list is removed.

3. Add a readout to the screen by navigating to the *Add readout* button on the UI and pressing it. You can move between the *Add readout* and *Remove readout* buttons by pressing the left and right arrow buttons on the control panel.
4. After pressing the *Add readout* button, select the readout to be added.

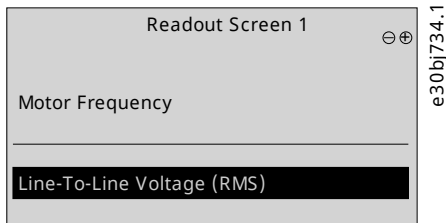

Figure 10: Readout Screen Update

5. Add more readouts by pressing the *Add readout* button and selecting a readout.
6. After selecting the readouts to be added or removed from the list, press *OK*.
7. To exit the screen content editing mode, press the *Home* or *Back* button.

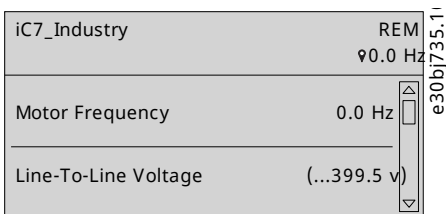

Figure 11: Updated Readout Screen

NOTICE

The readout screens can also be adjusted using *parameter group 8.3 Control Panel*. For more information, see Customization (Menu Index 8).

3.2.8 Parameter Group Screen and Overall Navigation

Pressing the Home/Menu button toggles between the readout screens and the parameter group screen. The content of the parameter group screen can vary depending on the current level of the parameter group. A typical parameter group screen is shown in the following image.

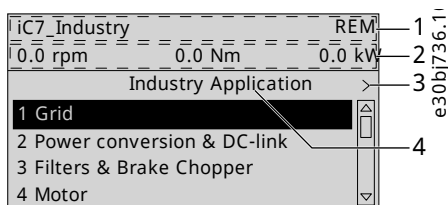

Figure 12: Parameter Group Screen

1	Name and control state of the drive.	2	The menu readout header. It shows the first 3 signals selected in <i>Readout Screen 2</i> . Editing this line also affects <i>Readout Screen 2</i> .
3	Previous and Next arrow icons. Press the icons to navigate 1 level above or below in the parameter group structure. When the Previous or Next arrow is not shown, it indicates that the view is at the top or bottom of the menu structure, respectively.	4	Name of the application software that is active in the drive.

Basic navigation techniques

To navigate through and within the different parameter groups, use the navigation buttons of the control panel.

- To navigate to different parameter groups, press the up or down arrows of the control panel.
- To navigate to parameter subgroups or parameters within a parameter group, press the left or right arrows of the control panel.
- To navigate to a higher level in the parameter/parameter group screens press the *Back* button, and to navigate to a lower level press the *OK* button.

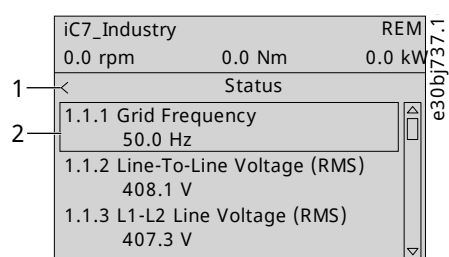

Figure 13: Parameter Navigation

1	Previous button when in a parameter group.	2	When parameters are defined as readout only, the current value is shown below the parameter name. A black outline around the parameter indicates that the value of the parameter cannot be changed.
---	--	---	---

3.2.9 Changing the Selections of a Parameter

When a parameter has selections, the parameter index and name are highlighted in black. The example parameter in this procedure is **P 5.8.6.2.1 Ramp 1 Type**.

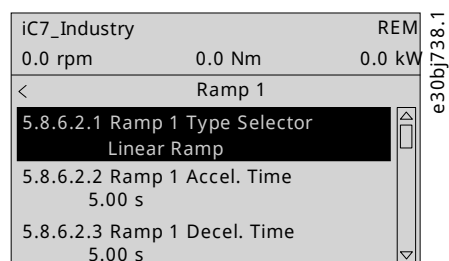

Figure 14: A Parameter with Selections

1. To view the selections of the parameter, press the right arrow button or *OK* on the control panel. The selections available for the parameter are shown on the screen.

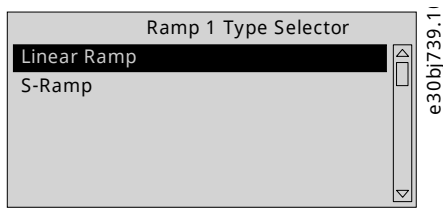

Figure 15: The Selections of a Parameter

2. To browse through the selections, press the up or down arrow buttons.
3. To select a selection, press *OK*.

3.2.10 Changing a Parameter Value

The example parameter in this procedure is *P 5.8.6.2.2 Ramp 1 Accel. Time*.

1. Go to *parameter 5.8.6.2.2 Ramp 1 Accel. Time* and press *OK*.

➡ The range of the parameter (minimum to maximum values) is shown at the bottom of the control panel display.

2. To go to the values before or after the decimals, use the left and right arrow buttons. A black highlight on the digit indicates the location where the cursor is active.
3. To increase or decrease the value, press the up and down arrow buttons.
4. Confirm the changes by pressing *OK*.

The following illustration shows the process of changing the value of a parameter.

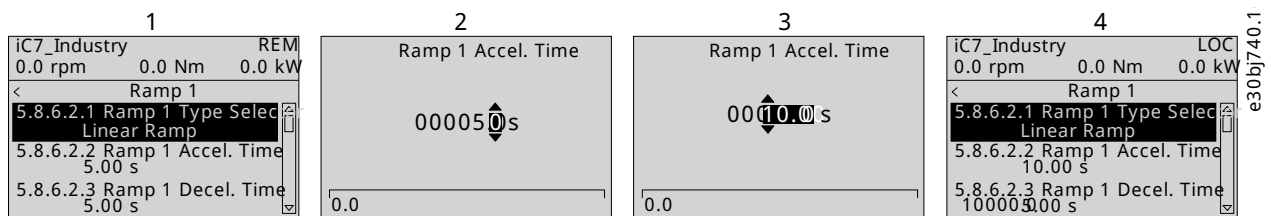

Figure 16: Changing the Value of a Parameter

3.2.11 Locking the Control Panel Display

To avoid unintended interaction via the control panel, the control panel display can be locked.

To lock the control panel, press the *Back* button for 3 seconds. After 3 seconds, the following screen is shown.

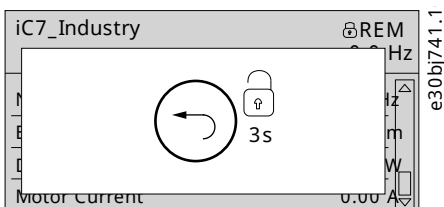

Figure 17: Control Panel Lock Screen

When the control panel is locked, pressing the control panel buttons has no effect.

To unlock the control panel, press the *Back* button for 3 seconds.

3.2.12 Control Panel Shortcuts

The following table lists shortcuts in navigating in the control panel.

Table 9: Control Panel Shortcuts

Action	Precondition	Buttons	Activation time
Fast scroll	When in a menu or list of choices	Up and down arrows	1 s to activate
Factory reset		<i>Home</i> + <i>Back</i> + down arrow	3 s to activate
Keypad lock		Back	3 s to activate or deactivate
Reference set point editing	<ul style="list-style-type: none"> • <i>Home</i> screen is active • LOC mode is active • Control is allowed 	[OK]	Single press
Editing <i>Home</i> screen readouts	<i>Home</i> screen active	[OK]	5 s to activate
Editing the Menu Readout header	Any menu is active	[OK]	5 s to activate
Show active events	<i>Home</i> screen is active	<i>Info</i>	Single press
Adjusting screen contrast and brightness	<i>Home</i> screen is active	<i>Info</i> + arrows	Continuous simultaneous press

3.3 MyDrive® Insight

3.3.1 Introduction to MyDrive® Insight

MyDrive® Insight is a platform-independent software tool that supports the commissioning, engineering, and monitoring of the iC7 series. Some of the key features include:

- Fast and easy configuration and commissioning
- Monitoring the drives as part of daily operations
- Collecting data and information for troubleshooting, maintenance, and service
- Discovering and accessing multiple drives in a network
- Intuitive user interface with notifications and visualizations on real time converter information and events
- PC control to perform operations such as starting or stopping the drive, set references, set direction, reset, and coast of the drive
- Performing updates on single or multiple drives
- Backing up and restoring parameter settings
- Data logging and analyzing for troubleshooting



Note: The section is documented for MyDrive® Insight version 2.11.2 or above. To utilize the latest MyDrive® Insight functions, make sure to uninstall lower versions of MyDrive® Insight from the workstation.



Note: The section MyDrive® Insight in the application guide covers basic information such as getting started with MyDrive® Insight, accessing and viewing or changing the parameters, and PC control to operate the drive using MyDrive® Insight. For further information on the different MyDrive screens, integrated help within MyDrive® Insight will be available in future releases.

3.3.2 Getting Started with MyDrive Insight

As a prerequisite, ensure that MyDrive® Insight is installed on the device (PC or laptop). MyDrive® Insight can be downloaded and installed from MyDrive® Suite, available here: <https://suite.mydrive.danfoss.com/>

1. To establish a point-to-point connection between the drive and the device, use the communication interface X0 and the RJ45 Ethernet port on the device by using a standard Ethernet cable.

If the device does not have an RJ45 Ethernet port or it is already in use, then a conventional adapter from USB-C to RJ45 can be used. To connect several drives at the same time, use an Ethernet switch between the PC and the control unit.

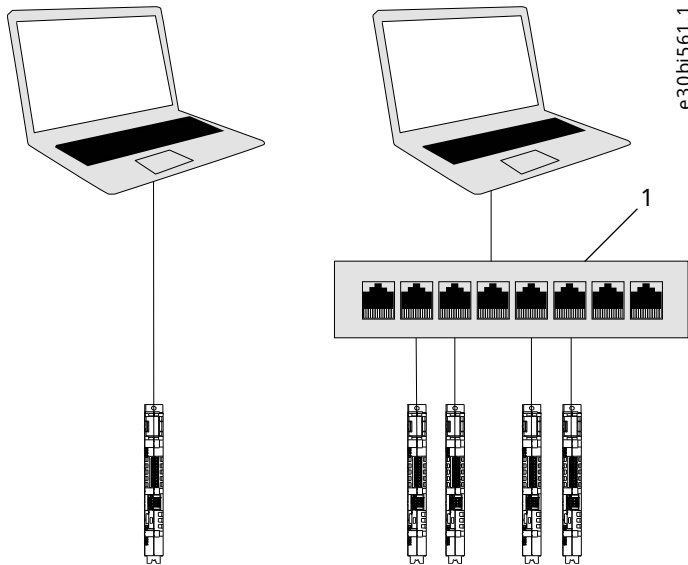

Figure 18: Connection to the PC

1 Ethernet switch

2. When the drive is powered up and in *Ready* state, open MyDrive® Insight on the device and the drive is recognized.
3. To establish or confirm the connection, click the arrow button.

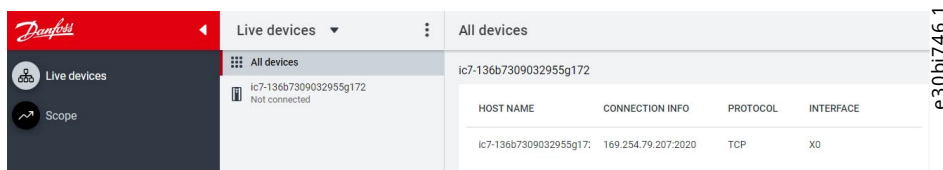

Figure 19: Confirm Connection

Once the connection is established, the drive is marked with a green connection symbol in MyDrive® Insight.

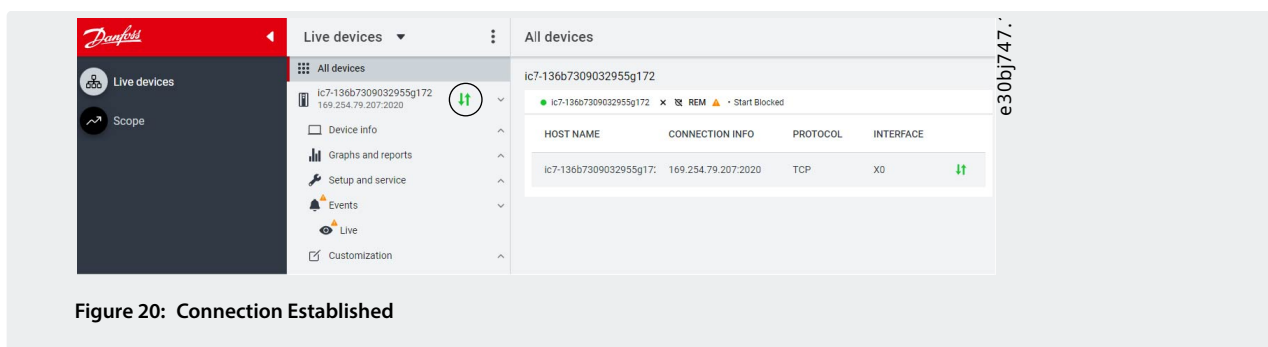

Figure 20: Connection Established

4. To interact with the drive, navigate to the required screen in MyDrive® Insight. The example picture shows the Device Info screen.

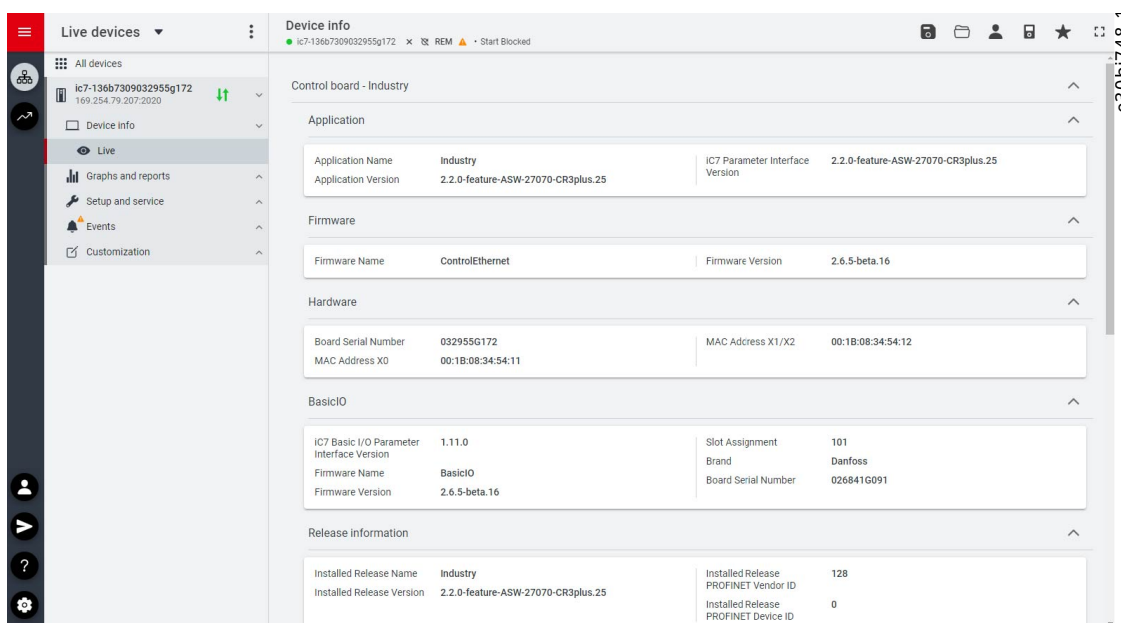

Figure 21: Device Info

Note: The application guide covers basic information such as accessing parameters and using MyDrive® Insight as the PC control place.

3.3.3 Accessing Parameters and Understanding Parameter Screens in MyDrive® Insight

1. To access the parameters of the connected drive, click Setup and Service.
2. Click *Parameters* > *Live*.

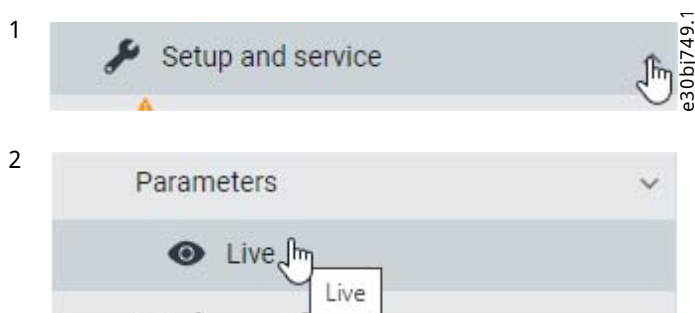

Figure 22: Setup and Service

➔ The Parameters (Live) screen opens.

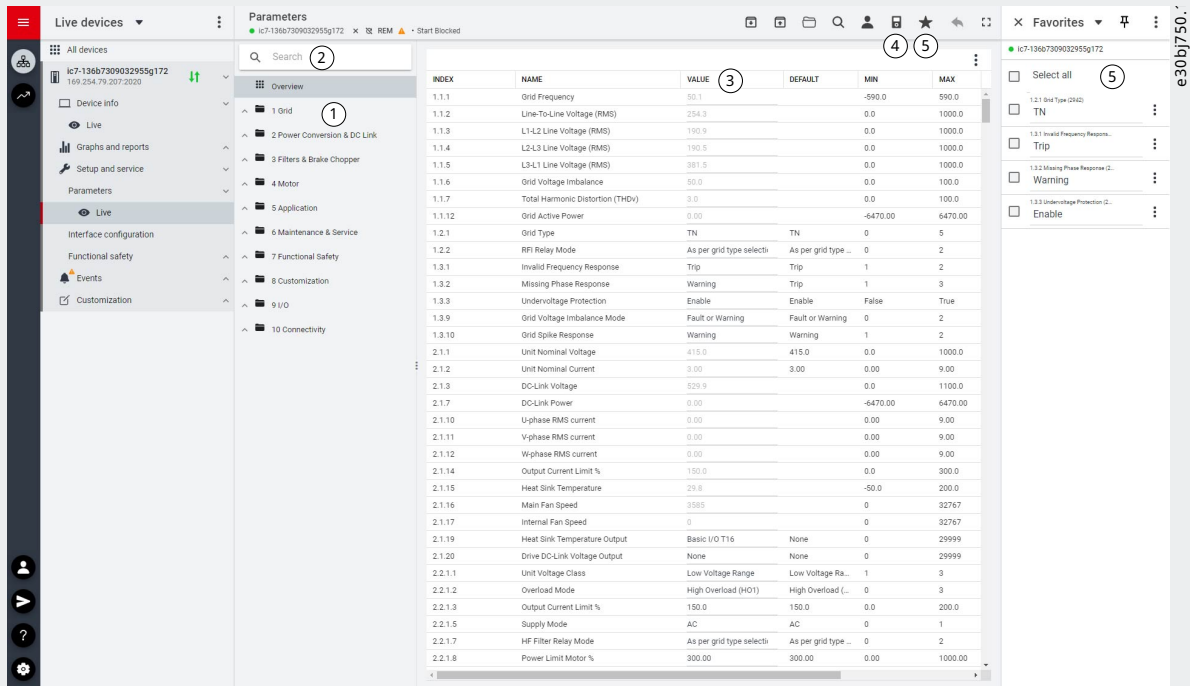

Figure 23: Parameters (Live)

- | | |
|---|---|
| <p>1 Parameter group: Navigate through the different parameter groups in the drive.</p> <p>3 Value field: View and change a parameter value or selection. All the parameters for the drive are shown on the Live screen.</p> <p>5 Favorites: Select a parameter as a favorite by clicking the star in its row. Open the favorites panel on the right side of the screen by clicking the star at the top of the page.</p> | <p>2 Search field: Use the search function to find a specific parameter.</p> <p>4 <i>PC Control</i> button: Switch to PC control to start or stop the drive using MyDrive® Insight.</p> |
|---|---|

3. Navigate through the parameter groups.

- a. Click the parameter group (1) from the Live pane.
- b. Click the parameter subgroup (2).
- c. Repeat step 2 until the right level of parameter sub group (3) is reached to find the specific parameters (4).

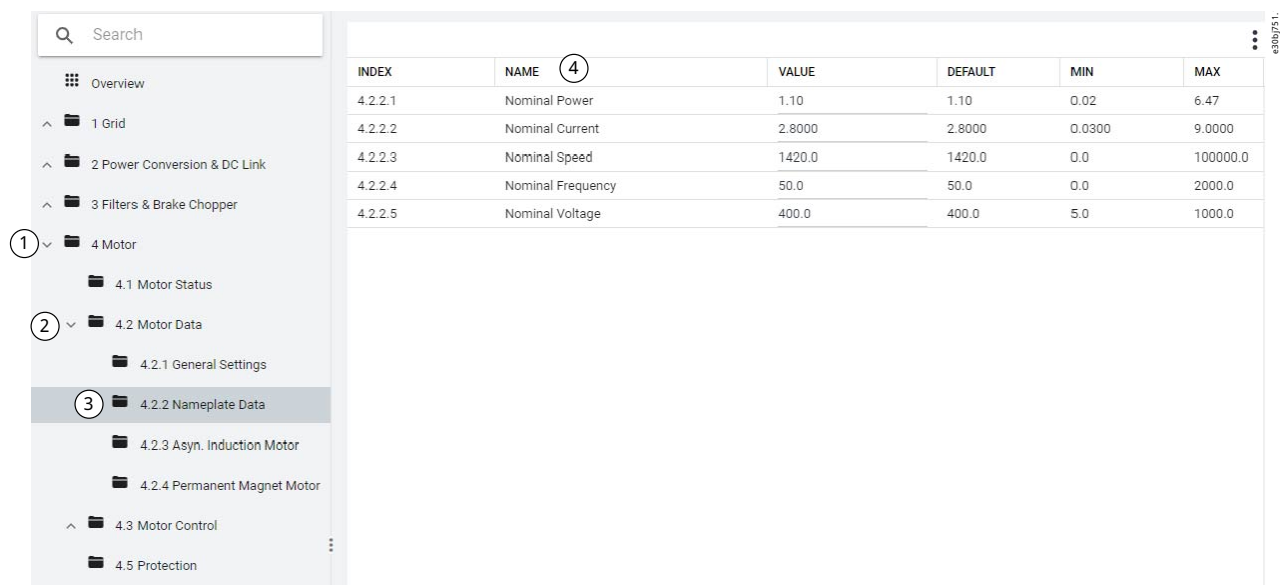

Figure 24: Navigating the Parameter Groups

Note: When in a specific parameter subgroup, only parameters in that parameter subgroup can be accessed.

Searching for a specific parameter

Type the search term in the *Search* field. The search returns all parameters that have the search term in the name.

In the following example, all parameters with *DC-Link* in the name are listed in the search results.

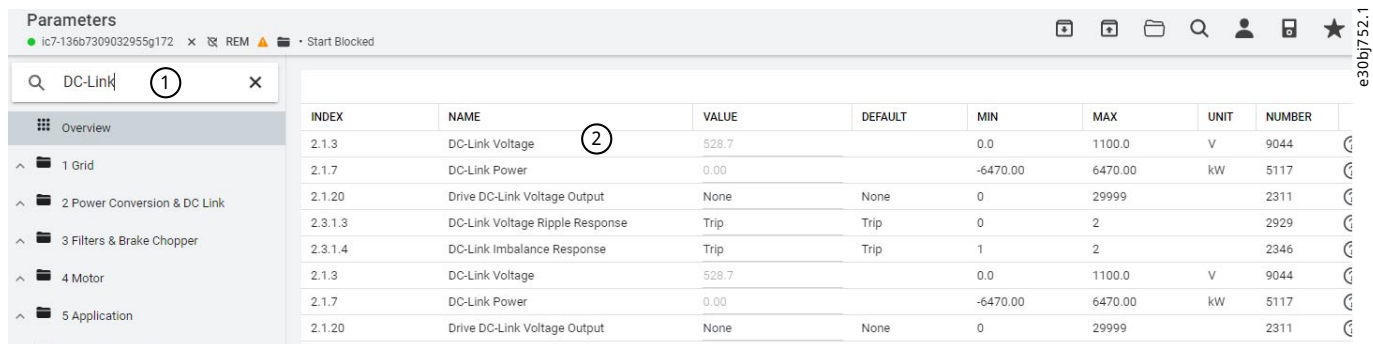

Figure 25: Search Function

1	Search term	2	Search results
---	-------------	---	----------------

3.3.4 Viewing and Changing Parameter Settings

When in a specific parameter group, all parameters related to the parameter group are shown. Depending on the access type of the parameter, there is a possibility to view the parameter setting or change the current selection or value of the parameter.

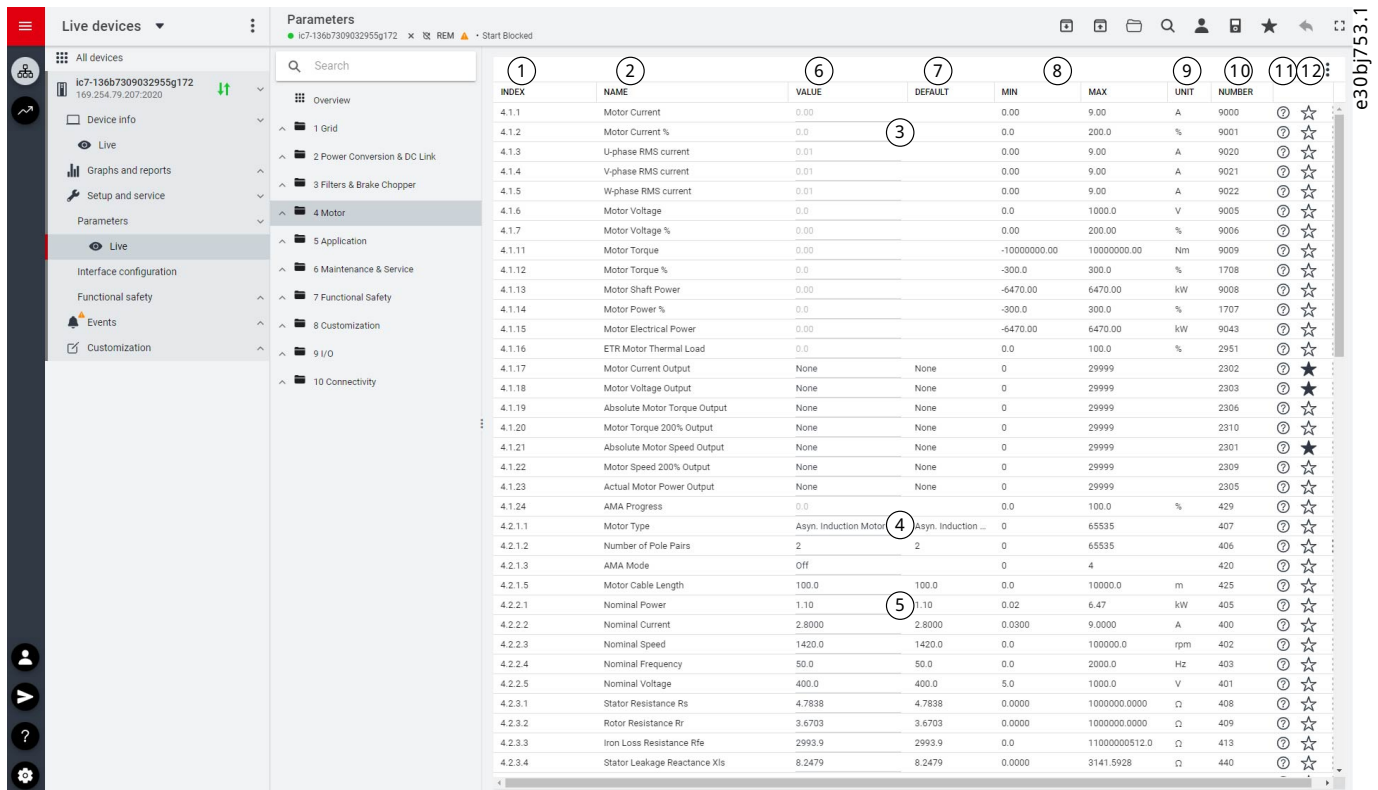

Figure 26: Parameter Overview

Table 10: Legend Table

Legend	Description	Further information
1	Index	Based on the parameter group structure, the index defines the location of the parameter. The index is not used as a unique identifier of a parameter.
2	Name	Name of the parameter.
3	Status parameters	The current status or value of a parameter. The parameter value is shown in a light gray color and cannot be changed.
4	Selection parameters	To see all selections available for the parameter, click the value in the Value field.
5	Range parameters	The parameter value can be modified based on the defined range (maximum and minimum values).
6	Value	The current value of the parameter.
7	Default	The factory setting (default value) of the parameter.
8	Min and Max	When applicable, the minimum and maximum values of the parameter are shown in the Min and

Table 10: Legend Table (continued)

Legend	Description	Further information
9	Unit	When applicable, the unit of the parameter is shown in the Unit field.
10	Number	The unique identifier for each parameter. The identifier is independent and decoupled from the parameter index values.
11	Help	Click the ? button to see a description about the parameter. For more detailed descriptions, see 6 Parameter Descriptions.
12	Favorites (star)	Clicking the Favorites icon adds the parameter to Favorites.

3.3.5 PC Control: Operating the Drive Using MyDrive® Insight

To operate the drive using PC control, click the Control Panel button in MyDrive® Insight. The following illustration shows the required steps to operate the drive via MyDrive® Insight.

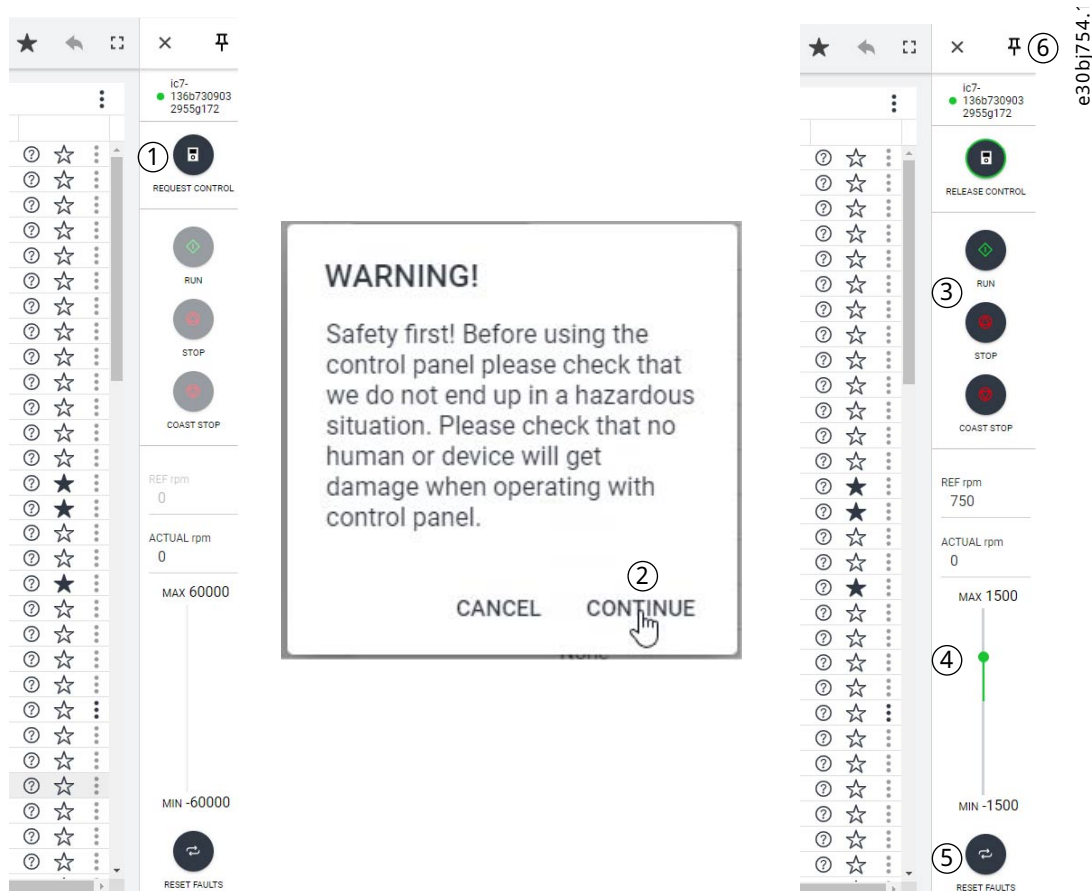

Figure 27: Operate the Drive Using MyDrive® Insight

1. Click the *REQUEST CONTROL* button (1).
2. To confirm secure operational conditions while controlling the drive using MyDrive® Insight, click *Continue* (2).

3. Use the *START*, *STOP*, and *STOP COAST* buttons (3) to perform drive operations. Use the sliders (4) to increase or decrease the reference speed.
4. To reset the drive in case of a fault, click *RESET FAULTS* (5).
5. For ease of access, click the Pin button (6) to make the control panel be constantly visible on the screen.

3.3.6 Datalogger

3.3.6.1 Introduction to Datalogger

The Datalogger in MyDrive Insight enables the monitoring of signals and related information for the selected signals.

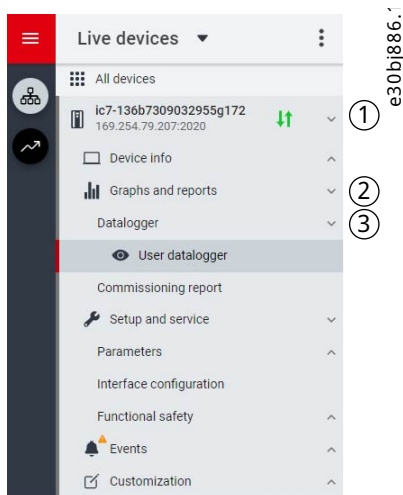

Figure 28: Navigating to Datalogger

To access the Datalogger feature, select the drive (1), then go to *Graphs and Reports* (2) > *Datalogger* (3)

The following image shows the Datalogger main controls:

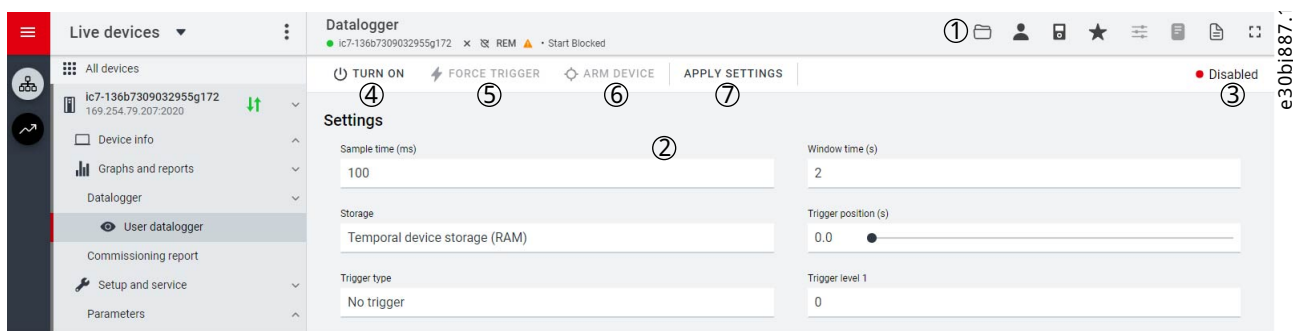

Figure 29: Datalogger Screen

- | | |
|---|---|
| <ol style="list-style-type: none"> 1 Open the window to select available Datalogger files for viewing. 3 Datalogger status. | <ol style="list-style-type: none"> 2 The list of Datalogger settings. 4 Enable or disable Datalogger. When disabled, all Datalogger configuration settings are inactive. When enabled, Datalogger is active and operates based on the configuration settings. |
|---|---|

- 5 Activate the force trigger. The 0–1 transition (rising edge) triggers Datalogger manually. This function is typically used with automatic triggers.
- 6 Arm Datalogger. The 0–1 transition (rising edge) readies Datalogger for triggering.
- 7 Apply any changed settings.

3.3.6.2 Configuring Datalogger

There are 2 main steps to configuring Datalogger:

- Configure the signals to be recorded using Datalogger.
- Configure the Datalogger settings.
 1. Open Datalogger
The *Settings* view opens.
 2. Enter the required and desired settings.

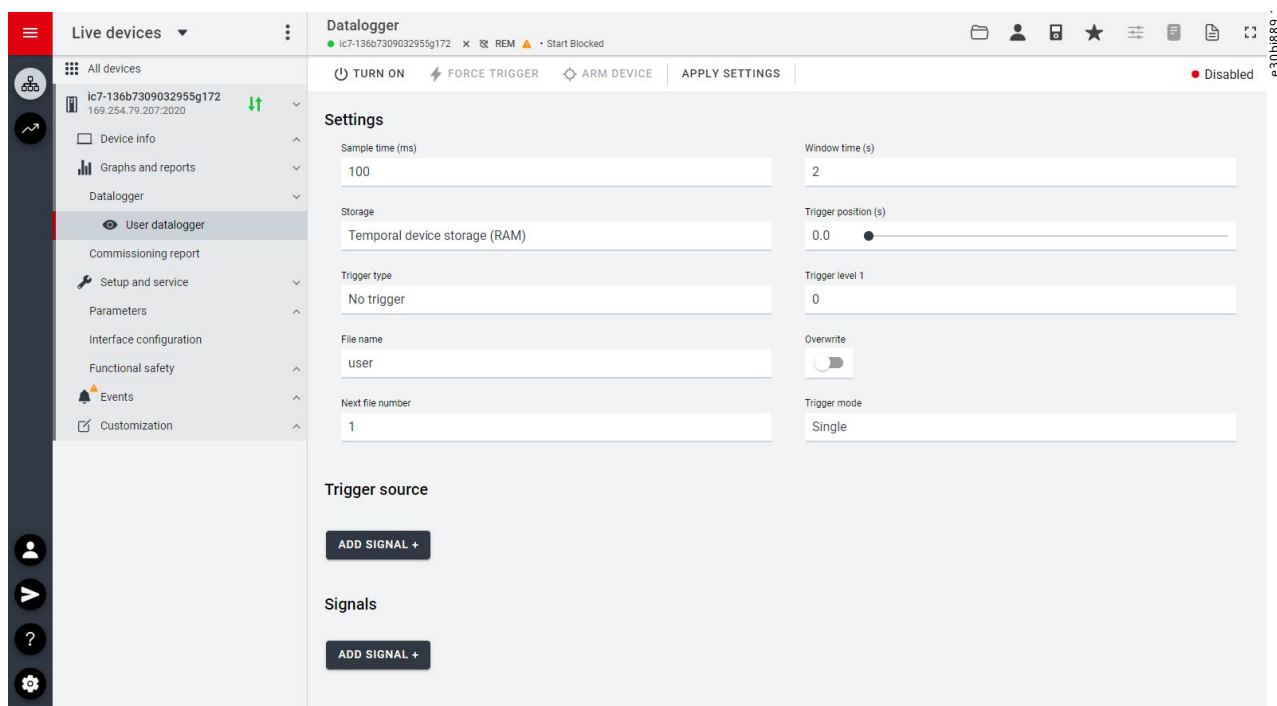

Figure 30: Datalogger settings

The following table describes the user interface elements:

Table 11: Datalogger Settings Fields

Field name	Field description
Sample time (ms)	Enter a sample time in ms. The actual sample time depends on the switching frequency. Fast sample rate settings result in data changing slowly in the resulting log.
Window time (s)	Defines the size of the capture window. Enter the window time in seconds. High sample rates and large capture times that result in large capture files may be rejected when the configuration is applied.
Storage	Select the location to which datalogger files are stored. Available selections are: <ul style="list-style-type: none"> • RAM: Settings are stored to the RAM of the drive. • Flash: Settings are stored to the flash of the drive. • SD card: Data is stored on the (optional) microSD card. The microSD cards supported are: SD, SDHC, or SDXC which must be formatted for the FAT32 file system. SDHC is the recommended type, as they are delivered preformatted to FAT32.
Trigger position (s)	Adjust the slider to position the trigger. Setting the trigger position to 0 indicates the datalogger recording starts at the time of the trigger. Setting a negative value indicates that the datalogger recording starts after the trigger has occurred. Setting a positive value indicates that the datalogger recording starts before the trigger has occurred.

Table 11: Datalogger Settings Fields (continued)

Field name	Field description
Trigger type	<p>Following are the trigger types:</p> <ul style="list-style-type: none"> • No trigger(manual trigger only). • Equaltriggers when the value of the trigger source variable is equal to trigger level 1. • Not equaltriggers when the value of the trigger source variable is not equal to trigger level 1. • Greater thantriggers when the value of the trigger source variable is greater than trigger level 1. • Greater than or equal to triggers when the value of the trigger source variable is greater than or equal to trigger level 1. • Less thantriggers when the value of the trigger source variable is less than trigger level 1. • Less than or equal to triggers when the value of the trigger source variable is less than or equal to trigger level 1. • Rising edgetriggers when the value of the trigger source variable rises above trigger level 1. If the trigger source is already above trigger level 1, the trigger must first drop below the trigger level. • Falling edgetriggers when the value of the trigger source variable falls below trigger level 1. If the trigger source is already below trigger level 1, the trigger must first rise above the trigger level.
Trigger level 1	<p>Defines the trigger level associated with the defined trigger type. This level is used for all single-level trigger types. The entry in the field defines the lower trigger level for window trigger types, such as bounds and out of bounds.</p>
File name	<p>Name of the file for datalogger recording.</p>
Overwrite	<p>To turn the overwrite function on or off, click the <i>Overwrite</i>-toggle button.</p> <ul style="list-style-type: none"> • On: Overwrite is enabled. A file number is not appended to the data log file. The datalogger overwrites a previous datalog file. • Off: Overwrite is disabled. A file number is appended to the log file. For each datalog, the datalog file is incremented and the previous datalog file is not overwritten.
Next file number	<p>The number entered in this field is appended to the initial datalog file. Entry in the field is useful when datalogs are previously available in the drive. The number is auto-incremented with each datalog recording when the entry in <i>Next file number</i> is enabled.</p>

Table 11: Datalogger Settings Fields (*continued*)

Field name	Field description
Trigger mode	Select 1 of the following trigger modes: <ul style="list-style-type: none"><li data-bbox="820 405 1382 501">• Single trigger mode: After a datalog recording, the datalogger must be rearmed before another trigger is allowed.<li data-bbox="820 517 1382 613">• Auto trigger mode: After a datalog recording, the datalogger automatically rearms and starts to accept triggers.

Table 11: Datalogger Settings Fields (continued)

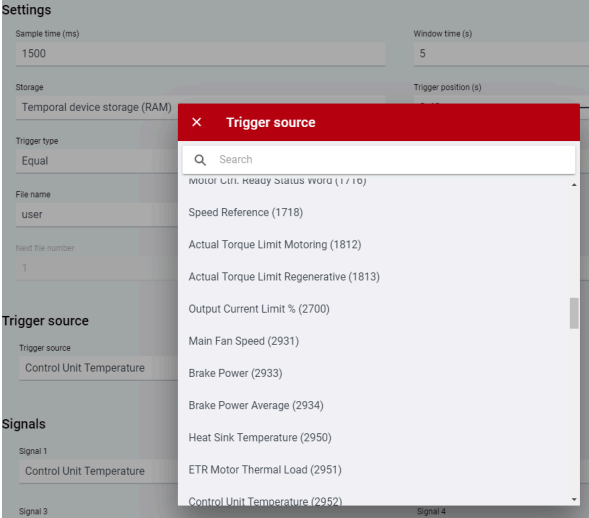
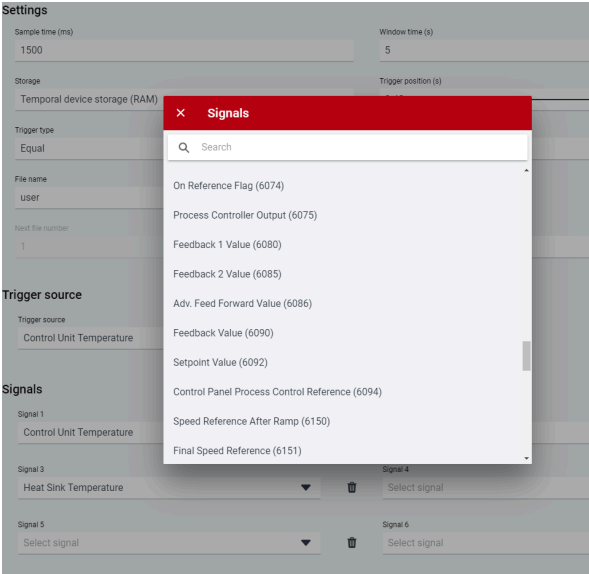
Field name	Field description
<p>Trigger source</p>	<p>Click the <i>Add signal</i> button under the <i>Trigger source</i> heading. A <i>Trigger source</i> field appears. Click the <i>Trigger source</i> field to select the signal source which is used for triggering the datalogger recording. The trigger source list opens in a new window:</p>  <p>Figure 31: Trigger source list</p>
<p>Signals</p>	<p>Click the <i>Add signal</i> button under the <i>Signals</i> heading. A <i>Signal</i> field appears. Click the <i>Signal</i> field to select the signals that are logged. The signal list opens in a new window:</p>  <p>Figure 32: Signals list</p>

3. Click *Apply settings*.

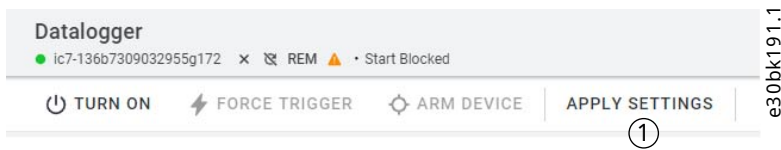

Figure 33: Apply settings

After the signal selection and the datalogger settings, the datalogger is ready to record the logs. To view a recorded datalog file, click the icon shown in the following figure.

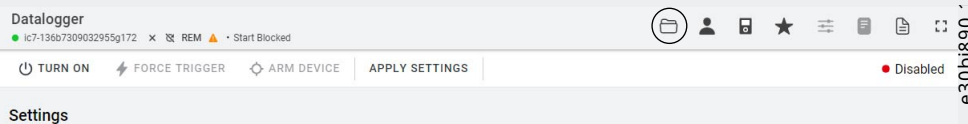

Figure 34: Datalogger view icon

3.3.7 Backup and Restore

3.3.7.1 MyDrive® Insight Backup

The Backup feature in MyDrive® Insight allows storing the parameter settings of the drive into a new or existing project file, RAM, or Flash memory of the drive, or to an optional microSD card.

To use the microSD card as a storage device, the microSD card must be inserted in the slot on the interface module located behind the control panel, as shown in the following image.

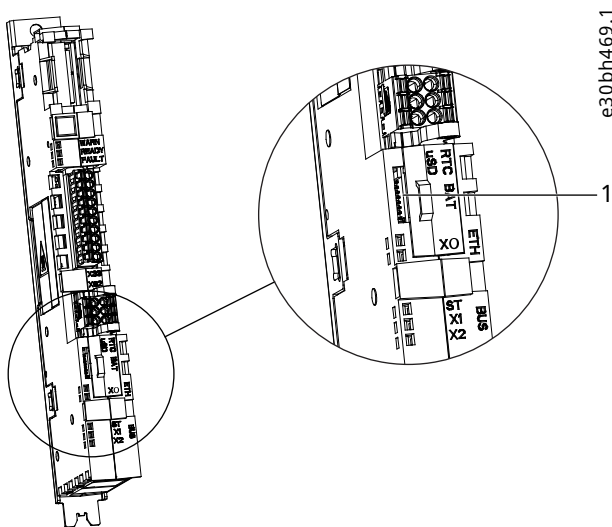

Figure 35: MicroSD Card Slot

- 1 The microSD card slot

The following are the types of microSD card supported by the interface module. The card must be formatted for the file system FAT32.

- Secure Digital (SD) card
- Secure Digital High Capacity (SDHC)
- Secure Digital Extended Capacity (SDXC)

Note: It is recommended to use SDHC cards as they are delivered preformatted to FAT32.

3.3.7.2 Backing up the Drive

1. To back up the drive, select a drive, go to *Setup & Services > Parameters*.
2. Click the backup destination icon shown in the following figure.

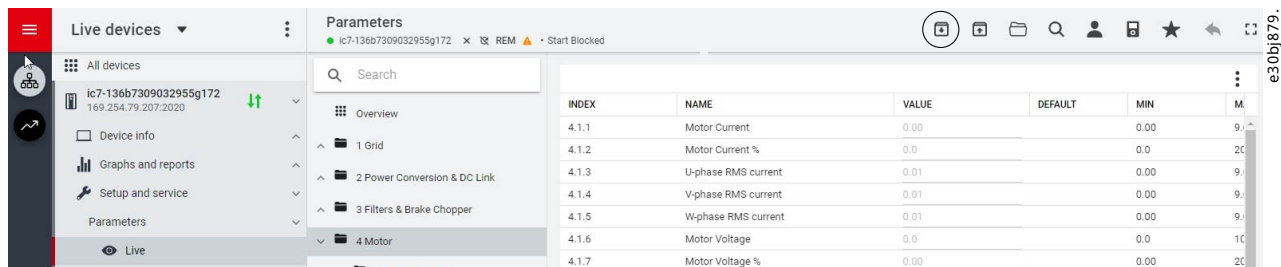

Figure 36: Backup Destination icon



A screen to select the backup destination opens. The destinations to back up are:

- o **Project:** The user can back up an existing project or a new project.
 - o **Device file system:** The user can back up to 1 of the available memory devices of the drive.
3. Click *Next*.
 4. This step depends on the backup destination selection:
 - a. If *Project* was selected, give the backup file a name and description.
 - b. If *Device file system* was selected, select where to save the backup. The selections are flash, RAM, or an (optional) microSD card. It is possible to specify a name for the backup file as well.
 5. Click *Backup* to begin backup.



Once backup is completed, a notification screen about it appears. If a *Project* backup was created, the backup is shown in the device menu under *Parameters*.

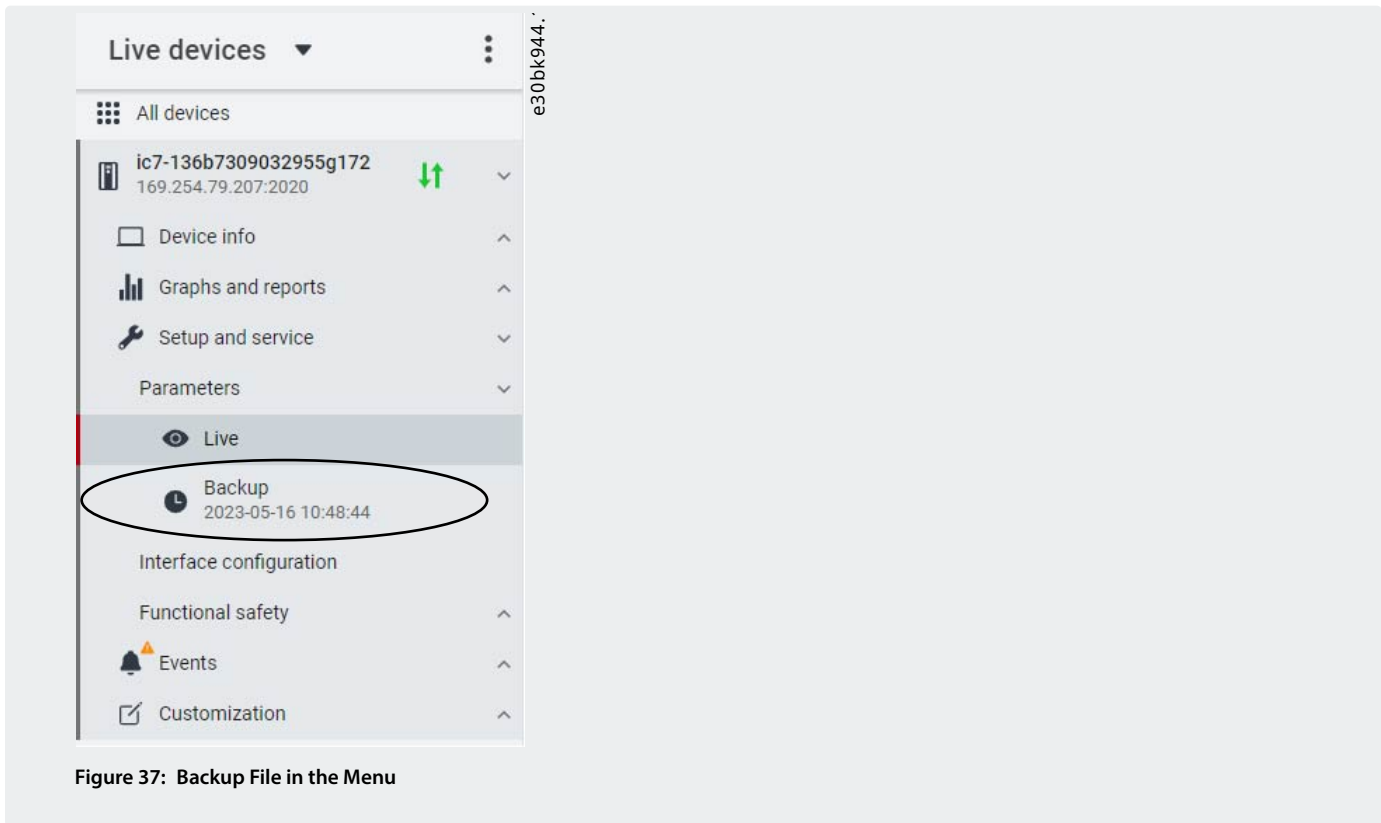

Figure 37: Backup File in the Menu

3.3.7.3 Restoring the Data to the Drive

1. To restore data to the drive, select a drive, and go to *Setup & Service > Parameters*.
2. Click the *Restore Data* icon shown in the following image.

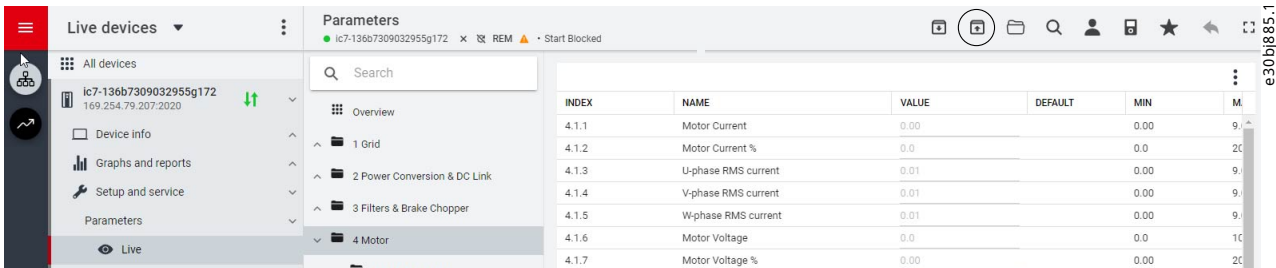

Figure 38: Restore Data Icon

3. Select the source of the data which is to be restored to the drive.

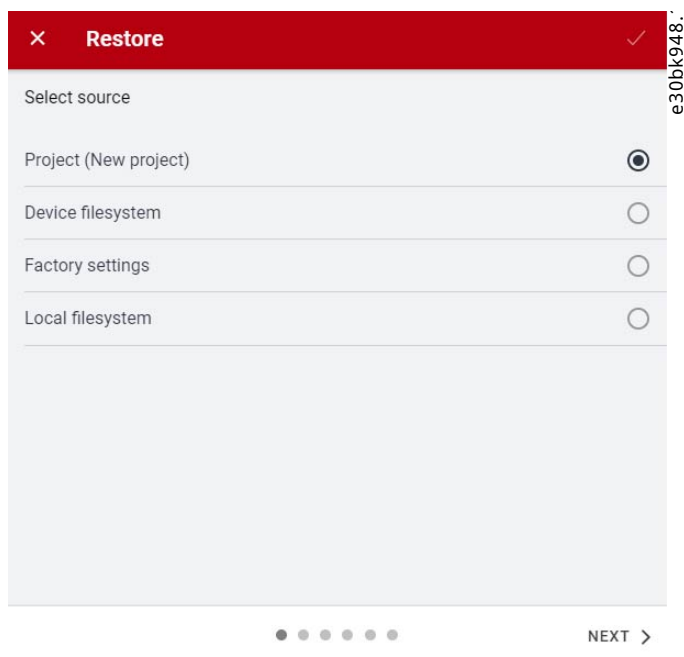

Figure 39: Source of Data to Restore

4. Click *Next* to select the backup source device and view the available backup files.
5. If *Project* is the restore source, select the correct backup to restore. Click *Next*.

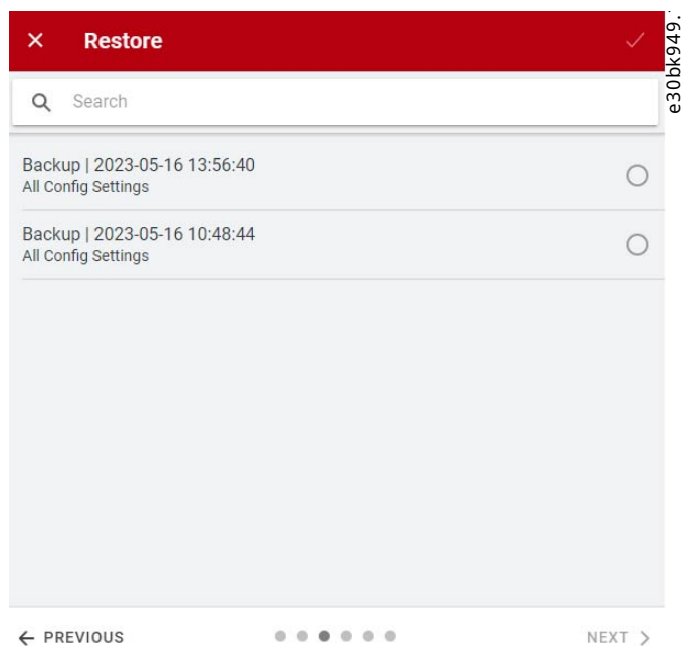



Figure 40: Select the Backup

6. Select the files for restoring data into the drive, as shown in the following image, and click *Next*.

 **Note:** It is possible to exclude Ethernet port settings when restoring the data.

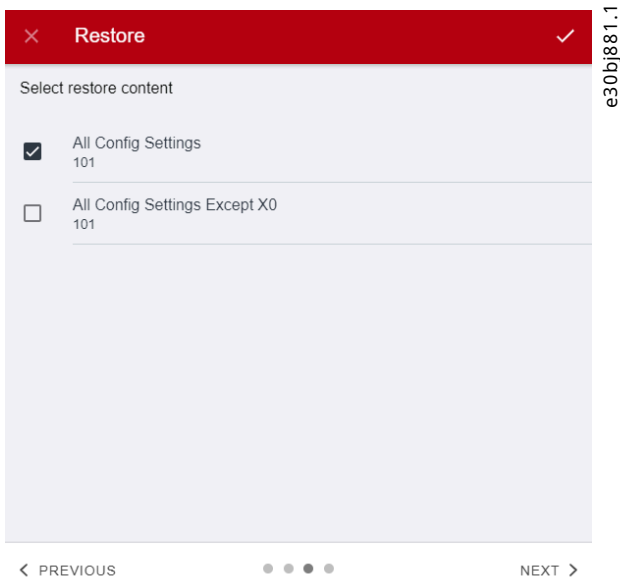

Figure 41: Restore Data

7. The system asks you to confirm the restore action. Click *Restore*.

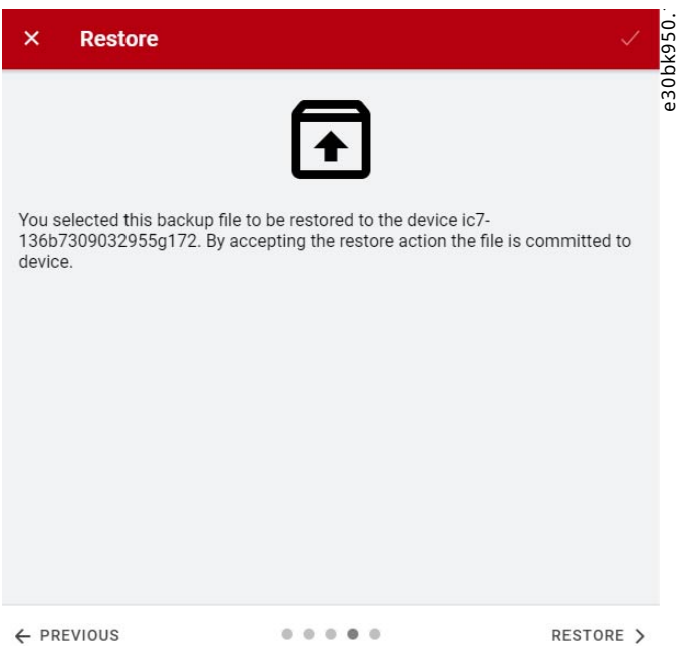

Figure 42: Confirm the Restore

If the data restore is successful, a message is shown.

4 Application Software Structure and Overview

4.1 Understanding Application Software Structure Principles

The basic design principle of the application software structure and the related hierarchy refers to the setup of a typical iC7 drive.

The same application software structure is reused across all products within the iC7 series. This means that some of the parameter groups or dedicated parameters may not be visible for all applications. Therefore, the indexes of parameters may not be sequential. This design principle is followed to maintain consistency across all the different application software in the iC7 series. The application software is designed in this manner to have the same look and feel across different iC7 series products, and enable easier and faster troubleshooting.

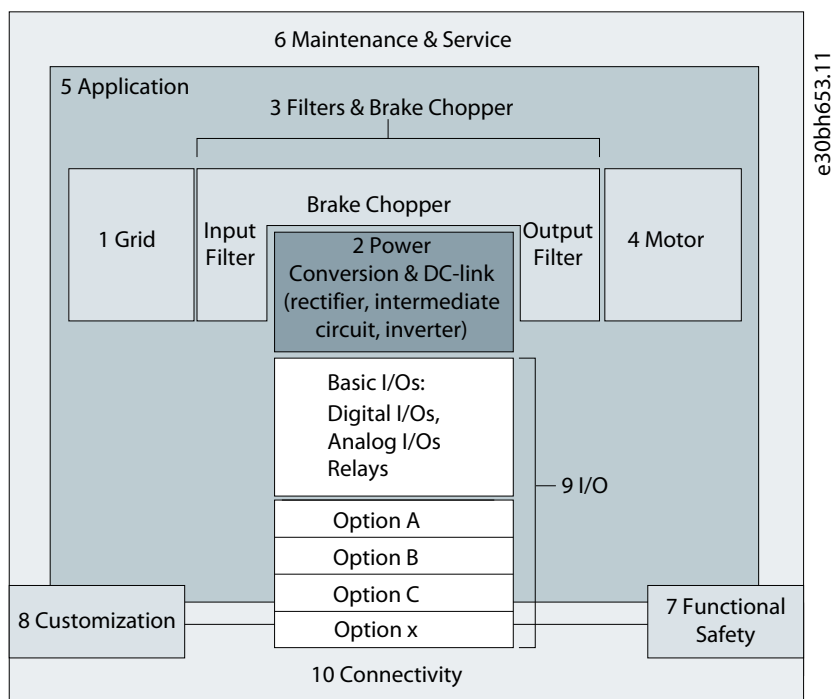

Figure 43: Application Software Structure Overview

4.2 Parameter Groups and their Content

The detailed structure and hierarchy within the parameter groups can vary, depending on the purpose of the parameter group and the total number of parameters. However, the design principle of the structure is to keep the overall sequence while commissioning or setting up the drive, within a logical structure. One example is the Status parameter group which is embedded into each main group (if applicable) to provide quick and easy access to view real time status information of relevant data of parameters within this group.

- All generic settings such as Grid, Power Conversion and DC Link, Filters and Brake Chopper, and Motor are accessed via parameter groups 1–4.
- Most of the application-specific parameters and the configuration of external control signals are accessed via parameter group 5 Application.
- Features and functions such as Maintenance and Service, Functional Safety, and Customization are accessed via parameter groups 6, 7, and 8.
- The hardware setup for the I/O interface, Options, and communication interfaces is done via parameter groups 9 and 10.
- The features and related parameters are grouped in individual parameter groups. Each feature has a parameter group of its own.
- Status information for each parameter group is available separately for easy access.
- The visibility of some parameters and parameter groups depends on the hardware used in the drive.

The following table provides information about the parameter groups.

Table 12: Parameter Groups

Index	Parameter group name	Description
1	Grid	Contains parameters for configuring and monitoring the energy source of the drive system. Typically, the energy source is the grid. The menu also lets you configure grid protection settings and view the condition of the grid.
2	Power Conversion and DC Link	Contains parameters to configure, monitor, and control the power conversion of the drive. The menu lets you configure protection settings of the power unit and settings for the rectifier, DC link, and inverter.
3	Filters and Brake Chopper	Contains parameters to configure, monitor, and control the input filters, output filters, brake chopper, and brake resistors.
4	Motor	Contains parameters to configure motor, motor control, and motor protection.
5	Application	Contains parameters for application specific features such as process control, speed control, torque control, mechanical brake control, and many more.
6	Maintenance and Service	Contains parameters exclusively related to status, events, and back up and restore.
7	Functional Safety	Contains non-safety-related parameters for configuring Safe Torque Off and other safety features.
8	Customization	Contains parameters to customize and adapt the behavior of the drive and user interface design.
9	I/O	Contains hardware-related parameters to configure I/Os and their options.
10	Connectivity	Contains parameters to configure the built-in and optional communications of the drive system.

Parameter group 1st level	Parameter group 2nd level	Parameter group 1st level	Parameter group 2nd level	Parameter group 1st level	Parameter group 2nd level
1 Grid	1.1 Grid Status 1.2 Grid Settings 1.3 Grid Protection	5 Application	5.1 Application Status 5.2 Protection 5.3 Load	6 Maintenance & Service	6.1 Status 6.2 Software Information 6.4 Events
2 Power Conversion & DC-link	2.1 Status 2.2 Power Unit Settings 2.3 Protection 2.4 Modulation		5.4 Operation Mode 5.5 Control Places 5.6 Start Settings 5.7 Stop Settings		6.5 Operational Counters 6.7 Backup & Restore 7.1 Status 7.2 STO
3 Filters & Brake Chopper	3.1 Filters & Brake Chopper Status 3.2 Brake Chopper 3.3 Brake Resistor 3.4 Advanced Harmonic Filter		5.8 Speed Control 5.9 Torque Control 5.10 Process Control 5.11 Inching	7 Functional Safety	8 Customization 8.2 Basic Settings 8.3 Control Panel
4 Motor	3.5 Output Filter 4.1 Motor Status 4.2 Motor Data 4.3 Motor Control 4.5 Protection		5.12 Mechanical Brake Control 5.26 Additional Status Outputs 5.27 Fieldbus Process Data	9 I/O	9.3 I/O Status 9.4 Digital Inputs/Outputs 9.5 Analog Inputs/Outputs
				10 Connectivity	10.2 Communication Interfaces 10.3 Protocols

e30bk019.12

Figure 44: Parameter Groups

5 Configuration Set-up Examples

5.1 Configuration Prerequisites

The section covers the basic configuration steps of a drive. It is possible that the application requires more steps such as protection settings. Use the following topics as reference during the drive configuration/commissioning process:

- For control panel related configurations, see [3.2.3 Control Panel Basic Configurations](#).
- For information on using MyDrive Insight, see [3.3.2 Getting Started with MyDrive Insight](#).
- For detailed information about the parameters, see *Parameter Descriptions*.

NOTICE

Ensure that the drive is mounted safely according to the installation and safety instructions shipped with the drive.

See also the following schematic for the correct wiring:

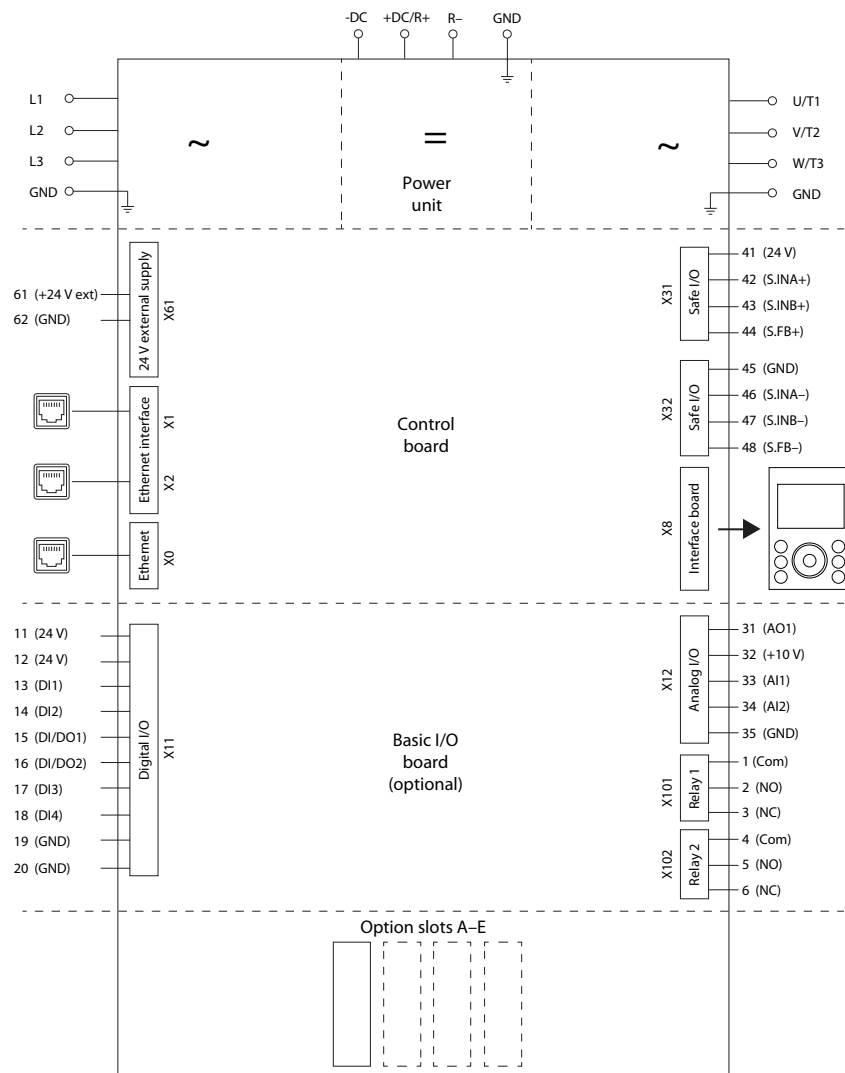

e30b/387.11

Figure 45: Wiring Diagram



Note: Selection lists with inputs and/or outputs consist of the name of the hardware option and the numbers of the terminals. For example, terminal number 13 of the Basic I/O is called Basic I/O T13 in the selection list.

5.2 Basic Setup of a Drive

The basic setup of the drive consists of the following configuration steps.

1. Configure the grid settings.

Index	Parameter name	Example setting	Parameter number
1.2.1	Grid Type	TN	2942

2. Configure the power unit settings.

Index	Parameter name	Example setting	Parameter number
2.2.1.1	Unit Voltage Class	Low-voltage range	2832
2.2.1.2	Overload Mode	High overload (HO1)	2833

3. Configure the operating mode.

Index	Parameter name	Example setting	Parameter number
5.4.2.16	Operation Mode	Speed control	2500
5.4.2.19	Motor Feedback Mode	Open loop	2502

4. Configure the control place settings.

Index	Parameter name	Example setting	Parameter number
5.5.2.1	Control Place Selection	Advanced control	114
5.5.3.1.2	Local Control Mode	Allow local control	107
5.5.6.1.1	Advanced Start Input	Fieldbus start, Basic I/O T13	4722
5.5.6.1.2	Advanced Start Logic	Source 1	1933
5.5.6.1.7	Advanced Coast Inverse Input	Fieldbus coast, Basic I/O T16	4724
5.5.6.1.8	Advanced Coast Inverse Logic	Source 1	1936

5. Configure the fieldbus communications (if available). See the relevant fieldbus guide.

6. Configure the readouts in the control panel. See Understanding Readout Screens.

5.3 Configuring the Motor, Motor Control, and Motor Thermal Protection

The required configuration steps depend on the motor type selected in parameter **4.2.1.1 Motor Type**.

NOTICE

The parameters specified in motor configuration cannot be adjusted when the motor is running.

1. Configure basic motor data. Go to **Parameter group 4** and specify the following:

Index	Parameter name	Parameter setting	Parameter number
4.2.1.1	Motor Type	Induction motor or Permanent magnet motor	407
4.2.2.1	Nominal Power	As on motor product label.	405
4.2.2.2	Nominal Current	As on motor product label.	400
4.2.2.3	Nominal Speed	As on motor product label.	402
4.2.2.4	Nominal Frequency	As on motor product label.	403
4.2.2.5	Nominal Voltage	As on motor product label.	401



Note: Changing the product label data causes a reset of the advanced motor data to default values, and the loss of AMA results.

2. Perform Automatic Motor Adaptation (AMA).

The advanced motor data, which are needed for optimal motor control performance and which are described in step 3, can be entered manually or measured and calculated based on AMA. The data measurement must be conducted in standstill with the following parameter:

Index	Parameter name	Parameter setting	Parameter number
4.2.1.3	AMA Mode	Motor data	420



Note: AMA requires an active start signal for execution. After AMA is performed, the setting of AMA Mode automatically switches to Off, and a notification must be confirmed. A new start signal is required for starting the motor. This is to avoid an unintended start caused by the active start signal. Consult the iC7 Series Frequency Converters Installation Safety Guide for safety information on unintended start.

3. Configure the advanced motor data if AMA is not performed. Setting these parameters are recommended for optimal motor control performance.

Table 13: Asynchronous Induction Motors

Index	Parameter name	Parameter setting	Parameter number
4.2.3.1	Stator Resistance Rs	Result of AMA or as on motor data sheet.	408
4.2.3.2	Rotor Resistance Rr	Result of AMA or as on motor data sheet.	409
4.2.3.3	Iron Loss Resistance Rfe	Result of AMA or as on motor data sheet.	413
4.2.3.4	Stator Leakage Reactance Xls	Result of AMA or as on motor data sheet.	440
4.2.3.5	Rotor Leakage Resistance Xlr	Result of AMA or as on motor data sheet.	441
4.2.3.6	Magnetizing Reactance Xm	Result of AMA or as on motor data sheet.	442

Table 14: Permanent Magnet Motors

Index	Parameter name	Parameter setting	Parameter number
4.2.4.2	Stator Resistance Rs	Result of AMA or as on motor product label.	408
4.2.4.3	d-axis Inductance Ld	Result of AMA or as on motor product label.	417
4.2.4.4	d-axis Inductance LdSat	Result of AMA or as on motor product label.	418
4.2.4.5	Ld Saturation Point	Result of AMA or as on motor product label.	426
4.2.4.6	q-axis Inductance Lq	Result of AMA or as on motor product label.	427
4.2.4.7	q-axis Inductance LqSat	Result of AMA or as on motor product label.	422
4.2.4.8	Lq Saturation Point	Result of AMA or as on motor product label.	424
4.2.4.1	Back EMF	Only for Permanent Magnet Motors. as on motor data sheet, as specified at 1000 RPM.	415

4. Configure motor control.

Index	Parameter name	Parameter setting	Parameter number
4.3.1.1	Motor Control Principle	FVC+ Control	2503
4.3.3.1	Continuous Rs Estimation	Enabled	428

Note: For motor control principles VVC+ and U/f, the following applies:

- Configure compensations for slip and different application conditions in parameter group **4.3.4 VVC+ & U/f Settings**.
- Enable and configure Automatic Energy Optimization (AEO) in parameter group **5.3.3 Torque & AEO**.
- For U/f, define the voltage and frequency points in parameter group **4.3.2 U/f Settings** as required for the application.

5. Configure motor thermal protection.

The Electronic Thermal Relay (ETR) function protects the motor from thermal overload without connecting an external device, by estimating the motor temperature based on present load and time. The ETR function meets the relevant requirements of UL 61800-5-1, including the Thermal Memory Retention requirement, and ensures a class 20 protection level. ETR can be configured and the motor thermal load can be viewed using the following parameters:

Index	Parameter name	Parameter setting	Parameter number
4.5.4	ETR Overtemperature Response	Fault, ramp to coast	2825
4.1.16	Motor Thermal Load (ETR)	Varies (Readout)	2951

The fault **0x7120-4177 Motor Thermal Overload** is issued when the motor thermal load has reached 100%.

5.4 Configuring Speed Control

This section describes the basic configuration for speed control in open loop.

The following procedure describes the additional steps to control the speed according to the following wiring diagram.

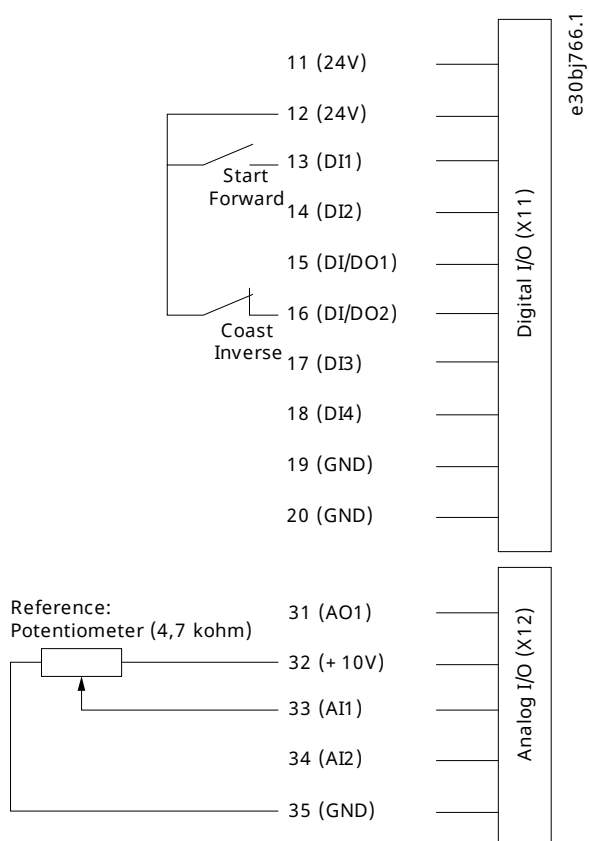

Figure 46: Wiring diagram example - Speed Control with Basic I/O

1. Perform the steps in [5.2 Basic Setup of a Drive](#).
2. Perform the steps in [5.3 Configuring the Motor, Motor Control, and Motor Thermal Protection](#).
3. Configure the operation mode for speed control.

Index	Parameter name	Example setting	Parameter number
5.4.2.16	Operation Mode	Speed control	2500
5.4.2.19	Motor Feedback Mode	Open loop	2502

4. Configure the type of speed reference used for the Advanced Control Place.

Index	Parameter name	Example setting	Parameter number
5.5.6.2.1	Adv. Speed Reference	Fieldbus reference, Reference 1 input	1915
5.5.6.2.2	Adv. Speed Reference Logic	Sum	1916

5. Configure speed limit settings.

Index	Parameter name	Example setting	Parameter number
5.8.3.1	Positive Speed Limit	1500 RPM	1729
5.8.3.2	Negative Speed Limit	-1500 RPM	1728
5.8.3.3	Minimum Speed Limit	0 RPM	1722

6. Configure the ramp.

Index	Parameter name	Example setting	Parameter number
5.8.6.1.1	Ramp Selector	Ramp 1	1100
5.8.6.2.1	Ramp 1 Type	Linear ramp	1125
5.8.6.2.2	Ramp 1 Accel. Time	5 s.	1101
5.8.6.2.3	Ramp 1 Decel. Time	5 s.	1105

7. Configure the reference and input settings according to the selected reference type.

Table 15: Reference Settings

Index	Parameter name	Example setting	Parameter number
5.8.4.1	Speed Reference 1 Input	Basic I/O T33	501
5.8.4.3	Speed Reference 1 Maximum	1500 RPM	1724
5.8.4.4	Speed Reference 1 Minimum	0 RPM	1725

Table 16: Basic I/O Settings

Index	Parameter name	Example setting	Parameter number
9.5.2.1	T33 Terminal Mode	Analog input	2020
9.5.2.2	T33 Terminal Type	Voltage	2273
9.5.2.3	T33 Minimum Value	0 V	2272
9.5.2.4	T33 Maximum Value	10 V	2271

8. Optional: Configure the settings for the Auto Tuning of the speed controller.

For achieving optimal motor control performance, perform an Inertia Estimation or, if the inertia is known, enter the inertia manually with parameter **5.3.2.3 System Inertia**.

Also perform an Auto Tuning of the speed controller settings. Auto tuning requires an inertia estimation value. Besides the settings already described, adjust the following:

Index	Parameter name	Example setting	Parameter number
5.8.11.1	Speed Controller Auto Tuning	Enabled	4546
5.3.2.1	Inertia Estimation Mode	Without load profile	668

 **Note:** The recommended setting for parameter **5.3.2.1 Inertia Estimation Mode** depends on the torque characteristic configured with parameter **5.3.3.1 Torque Characteristic**. Select **Without load profile** if there is a constant torque load, and **With profile** for a variable torque load.

- To start the tuning process, apply a start signal to terminal 13 of the Basic I/O .

5.5 Configuring Torque Control

While the drive is in torque control, the motor speed is monitored but not controlled. Therefore motor speed can reach the speed limits, when the load, application, or upper system are not within the speed limits. For this reason, it is important to set the limits of the output frequency as described in [5.4 Configuring Speed Control](#). Since speed ramps can also be used as limiting factor, check the ramp settings in step 6 of [5.4 Configuring Speed Control](#). Torque control is only available with the motor control principle FVC+.

The procedure is described according to the following wiring diagram.

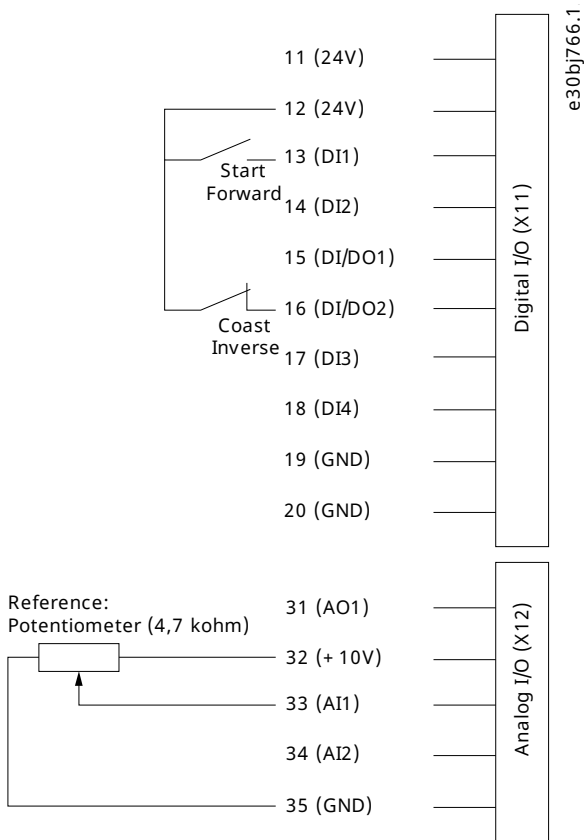

Figure 47: Wiring diagram example - Torque Control with Basic I/O

1. Perform the steps in 5.2 Basic setup of a Drive.
2. Perform the steps in 5.3 Configuring Motor, Motor Control, and Motor Thermal Protection.
3. Configure the operation mode for torque control.

Index	Parameter name	Example setting	Parameter number
5.4.2.16	Operation Mode	Torque control	2500

4. Configure the type of torque reference used for the Advanced Control Place.

Index	Parameter name	Example setting	Parameter number
5.5.6.2.4	Adv. Torque Reference	Fieldbus reference, Reference 1 input	1929
5.5.6.2.5	Adv. Torque Reference Logic	Sum	1919

5. Configure the torque limit settings.

Index	Parameter name	Example setting	Parameter number
5.9.2.1	Positive Torque Limit	150%	1810
5.9.2.2	Negative Torque Limit	-150%	1811
5.9.2.3	Motoring Torque Limit	100%	1321
5.9.2.4	Regenerative Torque Limit	100%	1323
5.9.2.5	Speed Limit Mode Torque Ctrl.	Pos./Neg. speed limit	2332

See more information about flexible limit modes in 6.6.9.3 Limits (Menu Index 5.9.2).

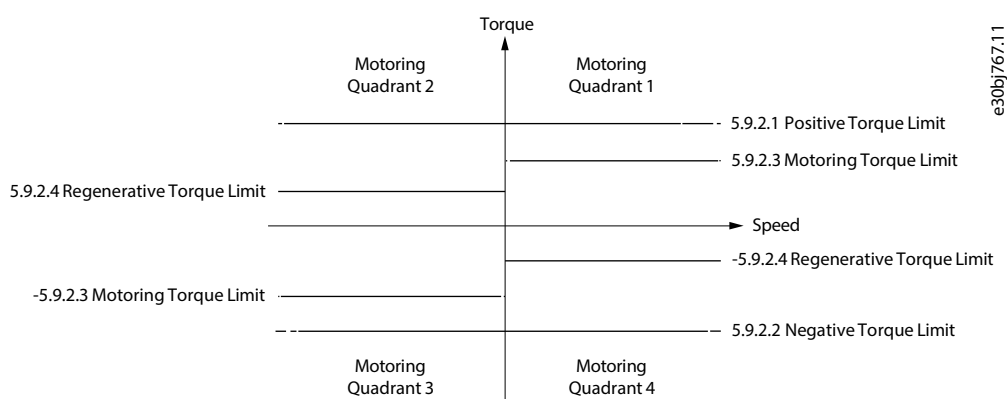

Figure 48: Torque Control Limits

6. Configure the reference settings and terminals used for the reference signal.

Table 17: Reference Settings

Index	Parameter name	Example setting	Parameter number
5.9.3.1	Torque Reference 1 Input	Basic I/O T33	4534
5.9.3.3	Torque Reference 1 Maximum	100%	4530
5.9.3.4	Torque Reference 1 Minimum	0%	4531
5.9.3.14	Torque Reference Ramp Time	10 s.	2330

Table 18: Basic I/O Settings

Index	Parameter name	Example setting	Parameter number
9.5.2.1	T33 Terminal Mode	Analog input	2020
9.5.2.2	T33 Terminal Type	Voltage	2273
9.5.2.3	T33 Minimum Value	0 V	2272
9.5.2.4	T33 Maximum Value	10 V	2271

5.6 Configuring Process Control

The built-in process controller is used to control processes based on the feedback sensor signal. Examples of controlled process variables are flow, pressure, and temperature. The process controller is used as a reference source for the speed controller. For this reason, a pre-condition of configuring the process control is to follow the instructions in the basic setup of a drive, configuring motor and motor control, and configuring speed control.

The auto-tuning simplifies the configuration and saves time during commissioning, while ensuring accurate PID control adjustment. In addition, the built-in controller supports inverse control for applications such as level control or the control of a vacuum pump. In such applications, increasing the drive speed decreases the feedback value.

This section describes the extra configurations required to set up a basic pressure control loop according to the following illustration and wiring diagram.

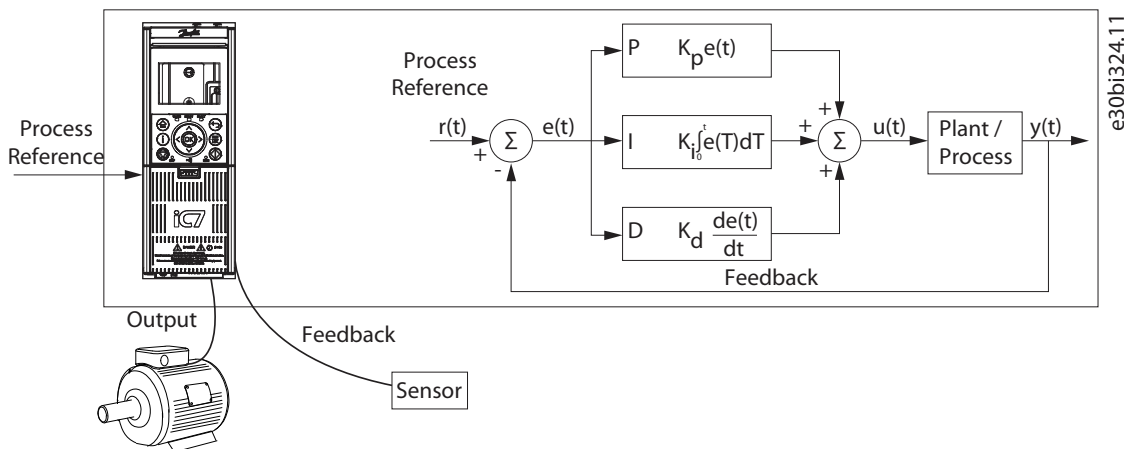

Figure 49: Process Controller

This configuration setup contains the following features:

- A pressure transducer to measure the pressure of the system. This data is used as feedback. The sensor is supplied power by the drive's 24 V supply.
- A potentiometer to adjust the setpoint, and a switch for the start signal which is connected to digital input 1 (terminal 13) on the Basic I/O. See the following wiring drawing example.

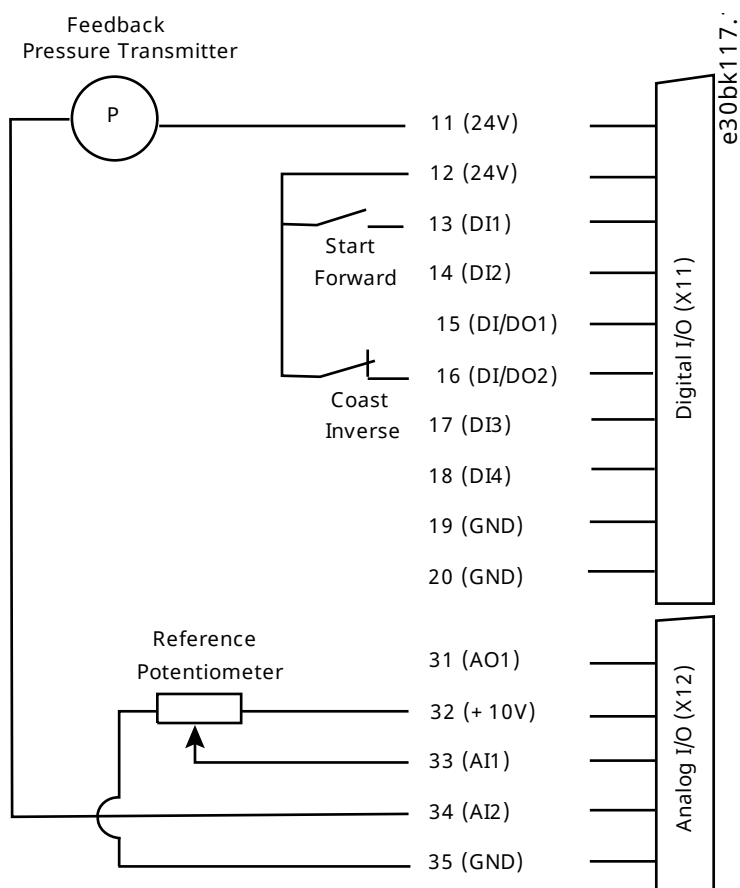

Figure 50: Wiring diagram example - Process Control with Basic I/O

1. Perform all the steps in [5.2 Basic Setup of a Drive](#).
2. Perform all the steps in [5.3 Configuring the Motor, Motor Control, and Motor Thermal Protection](#).
3. Perform all the steps in [5.4 Configuring Speed Control](#).
4. Select the process controller as reference in the settings for the control place.

Index	Parameter name	Recommended settings	Parameter number
5.5.6.2.6	Adv. Process Reference	Fieldbus reference/Reference 1 input	6054
5.5.6.2.7	Adv. Process Reference Logic	Source 1	6045

5. Adjust settings for the process reference and for the feedback according to the application. In this example, the operating range is 0–4 bar.

Index	Parameter name	Example setting	Parameter number
5.10.3.1	Process Reference Max.	4 bar	6013
5.10.3.2	Process Reference Min.	0 bar	6014

Index	Parameter name	Example setting	Parameter number
5.10.3.3	Process Reference 1 Input	Basic I/O T33	6025
5.10.4.1	Feedback Mode	Feedback 1	6008
5.10.4.2	Feedback 1 Type	Analog feedback terminal	6021
5.10.4.3	Feedback 1 Maximum Scaling	4 bar	6015
5.10.4.4	Feedback 1 Minimum Scaling	0 bar	6016
5.10.4.5	Analog Input Feedback 1	Basic I/O T34	6027

6. Configure the electrical characteristics of the analog input terminals 33 and 34 for reference and feedback.

Table 19: Terminal 33 Settings

Index	Parameter name	Example setting	Parameter number
9.5.2.2	T33 Terminal Type	Voltage	2273
9.5.2.3	T33 Minimum Value	0 V	2272
9.5.2.4	T33 Maximum Value	10 V	2271

Table 20: Terminal 34 Settings

Index	Parameter name	Example setting	Parameter number
9.5.3.2	T34 Terminal Type	Current	2279
9.5.3.3	T34 Minimum Value	4 mA	2278
9.5.3.4	T34 Maximum Value	20 mA	2277

7. To ensure optimum control performance for the system, perform auto-tuning of the process controller. The optimization of the settings is for the reference or a typical reference of the system.

Index	Parameter name	Example setting	Parameter number
5.10.7.1	Process Controller Auto Tuning	Enabled	6901
5.10.7.2	Auto Tuning Reference	2.3 bar	6902



Note: Default settings do not require modification before performing auto tuning.



Note: Parameter **5.10.7.1 Process Controller Auto Tuning** is disabled automatically after auto tuning is completed.

8. To start auto-tuning, apply a start signal to terminal 13 of the Basic I/O.

9. Enable the process controller.

Index	Parameter name	Example setting	Parameter number
5.10.1.10	Process Controller Enabled	Enabled	6053

10. In applications like pressure control with centrifugal pumps, additional energy savings can be achieved by using the Automatic Energy Optimization (AEO) function. To use this feature, configure the following parameters:

Index	Parameter name	Example setting	Parameter number
5.3.3.1	Torque Characteristic	Automatic Energy Optimization (AEO)	2809
5.3.3.2	AEO Minimum Speed	10 Hz	2810
5.3.3.3	AEO Minimum Magnetization	40%	2811



Note: To start the application a start signal is required, if the signal has been removed after completing auto-tuning.

6 Parameter Descriptions

6.1 Introduction to Parameter Descriptions

6.1.1 Reading the Parameter Table

The application guide includes parameter overview tables. The following descriptions explain how to read the parameters.

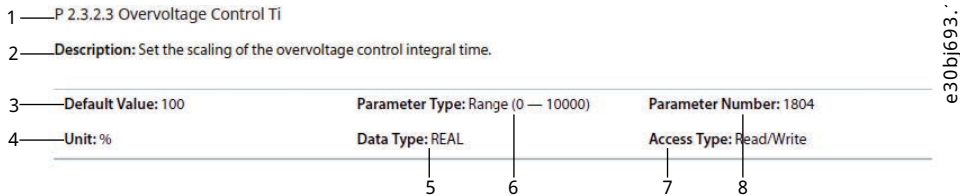

Figure 51: Reading the Parameter Table

1	The parameter index and name. Parameter indices start with a P.	2	The parameter help text which is visible in the control panel and MyDrive® Insight.
3	The default setting from the factory.	4	The unit of the parameter.
5	The data type of the parameter. See 6.1.2 Understanding Data Types .	6	The type of parameter. Parameters have either defined ranges of values or selections. See 6.1.3 Understanding Parameter Types .
7	The access type of the parameter. See 6.1.4 Understanding Access Types .	8	The unique parameter number, which is relevant for PLC programming.

6.1.2 Understanding Data Types

The following table is an overview of the data types used in the iC7 application software.

Table 21: Overview of data types

Data type	Description	Size (Bits)	Range
BOOL	Boolean	1	0–1
INT	Integer	16	-32,768 ... 32,767
DINT	Double integer	32	-2,147,483,648 ... 2,147,483,647
USINT	Unsigned short integer	8	0–255
UINT	Unsigned integer	16	0–65,535
UDINT	Unsigned double integer	32	0–4,294,967,295
REAL	Real numbers	32	-3.402823466 E+38 (approximately 7 digits) ... -1.175494351 E-38 (approximately 7 digits) and +1.175494351 E-38 (approximately 7 digits) ... +3.402823466 E+38 (approximately 7 digits)
WORD	Bit string of length 16	16	0–65,535 (16#00–16#FFFF)
STRING	Sequence of characters	N/A	1 byte per character

Table 21: Overview of data types (continued)

Data type	Description	Size (Bits)	Range
ULINT	Unsigned long integer	64	0–18446744073709551615
DATE_AND_TIME	Date and time information	64	N/A

6.1.3 Understanding Parameter Types

The following table lists the different types of parameters.

Table 22: Parameter Types and Descriptions

Parameter Type	Description
Selection	The parameter provides of a list of value selections.
Range (0–255)	The value of the parameter is within the specified range. In this example, the parameter can have any value between 0 and 255.
Range (*–*)	The value of the parameter can be set within the full range of the data type REAL. See 6.1.2 Understanding Data Types .
Range (0–*)	The value of the parameter can be set within the upper range of the data type REAL. See 6.1.2 Understanding Data Types .
Range (Unit dependent)	The range depends on the selected unit, and is visible in MyDrive Insight and the Control Panel.

6.1.4 Understanding Access Types

The following table lists the different parameter access types.

Table 23: Parameter Types and Descriptions

Access Type	Description
Read/Write	The parameter information can be read or changed.
Read only	The parameter information can only be read.
Read/Conditional Write	The parameter information can be read and changed. The parameter settings cannot be modified when the drive is running. The drive must be coasted to modify parameter values.

6.2 Grid (Menu Index 1)

6.2.1 Grid Overview

This parameter group contains parameters for configuring and monitoring the energy source of the drive system. Typically, the energy source is the grid. The menu also lets the user configure grid protection settings and view the condition of the grid.

6.2.2 Grid Status (Menu Index 1.1)

P 1.1.1 Grid Frequency

Description: Shows the actual grid frequency.

Default Value: NA	Parameter Type: Range (* — *)	Parameter Number: 9041
Unit: Hz	Data Type: REAL	Access Type: Read Only

P 1.1.2 Line-To-Line Voltage (RMS)

Description: Shows the average line-to-line voltage (RMS).

Default Value: NA	Parameter Type: Range (0 — *)	Parameter Number: 9040
Unit: V	Data Type: REAL	Access Type: Read Only

P 1.1.3 L1-L2 Line Voltage (RMS)

Description: Shows the L1-L2 line voltage (RMS).

Default Value: NA	Parameter Type: Range (0 — *)	Parameter Number: 9048
Unit: V	Data Type: REAL	Access Type: Read Only

P 1.1.4 L2-L3 Line Voltage (RMS)

Description: Shows the L2-L3 line voltage (RMS).

Default Value: NA	Parameter Type: Range (0 — *)	Parameter Number: 9049
Unit: V	Data Type: REAL	Access Type: Read Only

P 1.1.5 L3-L1 Line Voltage (RMS)

Description: Shows the L3-L1 line voltage (RMS).

Default Value: NA	Parameter Type: Range (0 — *)	Parameter Number: 9050
Unit: V	Data Type: REAL	Access Type: Read Only

P 1.1.6 Grid Voltage Imbalance

Description: Shows the grid voltage imbalance in %. A value greater than 3% may indicate grid problems.

Default Value: NA	Parameter Type: Range (0 — 100)	Parameter Number: 9047
Unit: %	Data Type: REAL	Access Type: Read Only

P 1.1.7 Total Harmonic Distortion (THDv)

Description: Shows the total harmonic distortion of the grid voltage (THDv) in %.

Default Value: NA	Parameter Type: Range (0 — 100)	Parameter Number: 9046
Unit: %	Data Type: REAL	Access Type: Read Only

P 1.1.12 Grid Active Power

Description: Shows the active power at the point of grid connection.

Default Value: NA	Parameter Type: Range (* — *)	Parameter Number: 9064
Unit: kW	Data Type: REAL	Access Type: Read Only

6.2.3 Grid Settings (Menu Index 1.2)

P 1.2.1 Grid Type

Description: Select the grid type of the supply system. The selection affects the setting of "1.2.2 RFI filter" and "2.2.1.7 HF DC-link Filter Mode" if set to "As grid type".

Default Value: 0 [TN]	Parameter Type: Selection	Parameter Number: 2942
Unit: -	Data Type: UINT	Access Type: Read/Conditional Write

The following are the selections for the parameter.

Selection Number	Selection Name	Selection Description
0	TN	Drive connected to a TN grid.
1	TT	Drive connected to a TT grid.
2	IT	Drive connected to a IT grid.
3	HRG	Drive connected to a High Resistance Grid (HRG).
4	Grounded Delta	Drive is connected to a grounded delta grid.

P 1.2.2 RFI Filter Mode

Description: Select the Radio Frequency Interference (RFI) filter mode.

Default Value: 2 [Filter matches grid type selection]	Parameter Type: Selection	Parameter Number: 2943
Unit: -	Data Type: UINT	Access Type: Read/Conditional Write

The following are the selections for the parameter.

Selection Number	Selection Name	Selection Description
0	Filter inactive	The filter is inactive.
1	Filter active	The filter is active.
2	Filter matches grid type selection	The filter is set according to the selected grid type.

6.2.4 Grid Protection (Menu Index 1.3)

P 1.3.1 Invalid Frequency Response

Description: Select the response after detection of invalid grid frequency.

Default Value: 1 [Fault]	Parameter Type: Selection	Parameter Number: 2337
Unit: -	Data Type: UINT	Access Type: Read/Write

The following are the selections for the parameter.

Selection Number	Selection Name	Selection Description
1	Fault	The drive issues a fault and stops.
2	Automatically derate	The drive continues operation with derated performance.

P 1.3.2 Missing Grid Phase Response

Description: Select the response after detection of a missing grid phase.

Default Value: 1 [Fault]	Parameter Type: Selection	Parameter Number: 2338
Unit: -	Data Type: UDINT	Access Type: Read/Write

The following are the selections for the parameter.

Selection Number	Selection Name	Selection Description
1	Fault	The drive issues a fault and stops.
2	Automatically derate	The drive continues operation with derated performance.
3	Warning	The drive issues a warning.

P 1.3.3 Undervoltage Protection

Description: Enables the undervoltage protection. The drive trips when the grid voltage is 20% below the selected voltage class level. The voltage class is defined in parameter "2.2.1.1 Unit Voltage Class".

Default Value: 1 [Enabled]	Parameter Type: Selection	Parameter Number: 2344
Unit: -	Data Type: BOOL	Access Type: Read/Write

The following are the selections for the parameter.

Selection Number	Selection Name	Selection Description
0	Disabled	Disables the function.
1	Enabled	Enables the function.

P 1.3.9 Grid Voltage Imbalance Response

Description: Select the mode of grid imbalance protection.

Default Value: 1 [Fault or Warning]	Parameter Type: Selection	Parameter Number: 9056
Unit: -	Data Type: UINT	Access Type: Read/Write

The following are the selections for the parameter.

Selection Number	Selection Name	Selection Description
0	Off	Disables the protection.
1	Fault or Warning	Issues a warning or fault if a grid voltage imbalance is detected.
2	Automatically derate	The drive continues operation with derated performance.

P 1.3.10 Grid Spike Response

Description: Select the response to grid voltage spike monitoring. If large spikes occur, it will protect the drive.

Default Value: 3 [Warning]	Parameter Type: Selection	Parameter Number: 2342
Unit: -	Data Type: UINT	Access Type: Read/Write

The following are the selections for the parameter.

Selection Number	Selection Name	Selection Description
3	Warning	The drive issues a warning.
9	Fault, ramp to coast	Issues a fault, ramps down, and coast.

6.3 Power Conversion & DC Link (Menu Index 2)

6.3.1 Power Conversion & DC-Link Overview

This parameter group contains parameters for configuring, monitoring, and controlling the power conversion of the drive. The group lets the user configure protection settings of the power unit and settings for the rectifier, DC link, and inverter.

6.3.2 Power Conversion & DC Link Status (Menu Index 2.1)

P 2.1.1 Unit Nominal Voltage

Description: Shows the nominal voltage setting as a result of the setting of parameter "2.2.1.1 Unit Voltage Class".

Default Value: 400	Parameter Type: Range (0 — *)	Parameter Number: 2830
Unit: V	Data Type: REAL	Access Type: Read Only

P 2.1.2 Unit Nominal Current

Description: Shows the nominal current of the unit.

Default Value: 23	Parameter Type: Range (0 — *)	Parameter Number: 2831
Unit: A	Data Type: REAL	Access Type: Read Only

P 2.1.3 DC-link Voltage

Description: Shows the actual DC-link voltage.

Default Value: NA	Parameter Type: Range (0 — *)	Parameter Number: 9044
Unit: V	Data Type: REAL	Access Type: Read Only

P 2.1.7 DC-link Power

Description: Shows the actual DC-link power.

Default Value: NA	Parameter Type: Range (* — *)	Parameter Number: 5117
Unit: kW	Data Type: REAL	Access Type: Read Only

P 2.1.10 U-phase RMS Current

Description: Shows the U-phase RMS current.

Default Value: NA	Parameter Type: Range (0 — *)	Parameter Number: 9020
Unit: A	Data Type: REAL	Access Type: Read Only

P 2.1.11 V-phase RMS Current

Description: Shows the V-phase RMS current.

Default Value: NA	Parameter Type: Range (0 — *)	Parameter Number: 9021
Unit: A	Data Type: REAL	Access Type: Read Only

P 2.1.12 W-phase RMS Current

Description: Shows the W-phase RMS current.

Default Value: NA	Parameter Type: Range (0 — *)	Parameter Number: 9022
Unit: A	Data Type: REAL	Access Type: Read Only

P 2.1.14 Actual Relative Output Current Limit

Description: Shows the actual output current limit relative to the nominal motor current.

Default Value: NA	Parameter Type: Range (0 — 300)	Parameter Number: 2700
Unit: %	Data Type: REAL	Access Type: Read Only

P 2.1.15 Heat Sink Temperature

Description: Shows the temperature of the power unit heat sink.

Default Value: NA	Parameter Type: Range (-50 — 200)	Parameter Number: 2950
Unit: °C	Data Type: REAL	Access Type: Read Only

P 2.1.16 Main Fan Speed

Description: Shows the speed of the main cooling fan.

Default Value: NA	Parameter Type: Range (0 — 32767)	Parameter Number: 2931
Unit: rpm	Data Type: INT	Access Type: Read Only

P 2.1.17 Internal Fan Speed

Description: Shows the speed of the internal cooling fan.

Default Value: NA	Parameter Type: Range (0 — 32767)	Parameter Number: 2926
Unit: rpm	Data Type: INT	Access Type: Read Only

P 2.1.19 Heat Sink Temperature Output

Description: Select the output indicating if the heat sink temperature is within range.

Default Value:	Parameter Type: Selection	Parameter Number: 2312
Unit: -	Data Type: UINT	Access Type: Read/Write

P 2.1.20 Drive DC-link Voltage Output

Description: Select the output indicating if the DC-link voltage is within range.

Default Value:	Parameter Type: Selection	Parameter Number: 2311
Unit: -	Data Type: UINT	Access Type: Read/Write

6.3.3 Power Unit Settings (Menu Index 2.2)

6.3.3.1 General Settings (Menu Index 2.2.1)

P 2.2.1.1 Unit Voltage Class

Description: Select the unit voltage class to optimize the performance of the drive.

Default Value: *	Parameter Type: Selection	Parameter Number: 2832
Unit: -	Data Type: UINT	Access Type: Read/Conditional Write

The following are the selections for the parameter.

Selection Number	Selection Name	Selection Description
1	Low-voltage range	Class 1 - Low-voltage range.
2	Mid-voltage range	Class 2 - Mid-voltage range.
3	High-voltage range	Class 3 - High-voltage range.

P 2.2.1.2 Overload Mode

Description: Select the overload mode.

Default Value: *	Parameter Type: Selection	Parameter Number: 2833
Unit: -	Data Type: UINT	Access Type: Read/Conditional Write

The following are the selections for the parameter.

Selection Number	Selection Name	Selection Description
0	Automatic	Combination of high and low overload. Drive will start at high overload, but switches to low overload for a period at too high load.
1	Low overload (LO)	Low overload (LO) operation. Provides overload current up to 110%.
2	High overload (HO1)	High overload (HO1) operation. Provides higher overload current up to 160% for acceleration.
3	High overload increased duty (HO2)	High overload with increased duty (HO2) operation. Provides higher overload current with shorter cycle times.

P 2.2.1.3 Relative Output Current Limit

Description: Set the output current limit relative to the motor nominal current from the nameplate.

Default Value: 150	Parameter Type: Range (0 — 200)	Parameter Number: 1325
Unit: %	Data Type: REAL	Access Type: Read/Write

P 2.2.1.5 Supply Mode

Description: Select the supply mode.

Default Value: 0 [AC]	Parameter Type: Selection	Parameter Number: 1328
Unit: -	Data Type: UINT	Access Type: Read/Conditional Write

The following are the selections for the parameter.

Selection Number	Selection Name	Selection Description
0	AC	Drive is supplied from AC grid.
1	DC	Drive is supplied from DC terminals.

P 2.2.1.7 HF DC-link Filter Mode

Description: Select the mode of the high-frequency filter in the DC link.

Default Value: 2 [Filter matches grid type selection]	Parameter Type: Selection	Parameter Number: 2944
Unit: -	Data Type: UINT	Access Type: Read/Conditional Write

The following are the selections for the parameter.

Selection Number	Selection Name	Selection Description
0	Filter inactive	The filter is inactive.
1	Filter active	The filter is active.
2	Filter matches grid type selection	The filter is set according to the selected grid type.

P 2.2.1.8 Relative Power Limit Motor

Description: Set the power limit in motor mode in % of nominal motor power.

Default Value: 300	Parameter Type: Range (0 — 1000)	Parameter Number: 1814
Unit: %	Data Type: REAL	Access Type: Read/Write

P 2.2.1.9 Relative Power Limit Generator

Description: Set the power limit in generator mode in % of nominal motor power.

Default Value: 300	Parameter Type: Range (0 — 1000)	Parameter Number: 1815
Unit: %	Data Type: REAL	Access Type: Read/Write

P 2.2.1.12 Output Current Limit Scale Input

Description: Select the input for scaling the output current limit between 0% and 100% value as defined in the current limit. Off equals 100%.

Default Value:	Parameter Type: Selection	Parameter Number: 1322
Unit: -	Data Type: UINT	Access Type: Read/Write

P 2.2.1.13 Output Current Limit Response

Description: Select the desired response for running in current limit after the time delay set.

Default Value: 0 [No response]	Parameter Type: Selection	Parameter Number: 2359
Unit: -	Data Type: UINT	Access Type: Read/Write

The following are the selections for the parameter.

Selection Number	Selection Name	Selection Description
0	No response	The event is ignored.
1	Info	The event is logged in the event log.
10	Fault	The drive issues a fault and coasts the motor.

P 2.2.1.14 Output Current Limit Delay

Description: Set the delay before the selected response is triggered after the drive has reached the current limit.

Default Value:	Parameter Type: Range (0 — 65000)	Parameter Number: 2360
Unit: s	Data Type: REAL	Access Type: Read/Write

P 2.2.1.15 Power Limit Motor Response

Description: Select the response for running within power limit after the time delay set.

Default Value: 0 [No response]	Parameter Type: Selection	Parameter Number: 2366
Unit: -	Data Type: UINT	Access Type: Read/Write

The following are the selections for the parameter.

Selection Number	Selection Name	Selection Description
0	No response	The event is ignored.
1	Info	The event is logged in the event log.
10	Fault	The drive issues a fault and coasts the motor.

P 2.2.1.16 Power Limit Motor Delay

Description: Set the delay before the selected response is triggered after the drive has reached the power limit.

Default Value:	Parameter Type: Range (0 — 65000)	Parameter Number: 2364
Unit: s	Data Type: REAL	Access Type: Read/Write

P 2.2.1.17 Power Limit Generator Response

Description: Select the response for running within power limit after the time delay set.

Default Value: 0 [No response]	Parameter Type: Selection	Parameter Number: 2367
Unit: -	Data Type: UINT	Access Type: Read/Write

The following are the selections for the parameter.

Selection Number	Selection Name	Selection Description
0	No response	The event is ignored.
1	Info	The event is logged in the event log.
10	Fault	The drive issues a fault and coasts the motor.

P 2.2.1.18 Power Limit Generator Delay

Description: Set the delay before the selected response is triggered after the drive has reached the power limit.

Default Value:	Parameter Type: Range (0 — 65000)	Parameter Number: 2365
Unit: s	Data Type: REAL	Access Type: Read/Write

6.3.3.2 Additional Information for Power Unit General Settings

P 2.2.1.1 Unit Voltage Class

This parameter specifies a focused voltage range within the input voltage rating of the power unit, for optimized drive control. Each power unit is rated for a wide input voltage range within which the drive can operate. This parameter is used to specify a narrower range within the wide range of input voltage, to determine optimized values for the nominal voltage and current of the power unit. The following table describes the selections available for the parameter.

Table 24: Selection Descriptions

Selection Name	Selection Description
Low Voltage Range	Unit nominal voltage and current are configured according to the lowest voltage of the power unit's voltage range. For example: In 380–500 V (3N05) rated units, the range is 380–440 V AC.
Medium Voltage Range	Unit nominal voltage and current are configured according to the medium voltage level of the power unit's voltage range. For example: In 380–500 V (3N05) rated units, the range is 441–480 V AC.
High Voltage Range	Unit nominal voltage and current are configured according to the highest voltage level of the power unit's voltage range. For example: In 380–500 V (3N05) rated units, the range is 481–500 V AC.

P 2.2.1.2 Overload Mode

When configuring a drive, it is important to know the load characteristic and load cycle of the application, so that it is possible to get the most out of the drive. The available output current depends on the application load profile. In addition, derating of the output current may be needed, for example, if operational temperature is increased, or the drive is installed in an altitude above 1000 m (3300 ft).

iC7-Automation drives support 4 different overload modes:

- Low overload (LO): 110% load for a minimum of 1 minute every 10 minutes.
- High overload (HO1): Up to 160% load for 1 minute every 10 minutes, with a breakaway torque of up to 200%.
- High overload with increased duty (HO2): In drive parameters, this mode is called High overload (HO2). Up to 160% load for 1 minute every 5 minutes and with a breakaway torque of up to 200% in the start of the process.
- Automatic: In this mode, the drive automatically switches between LO and HO1 depending on the load conditions.

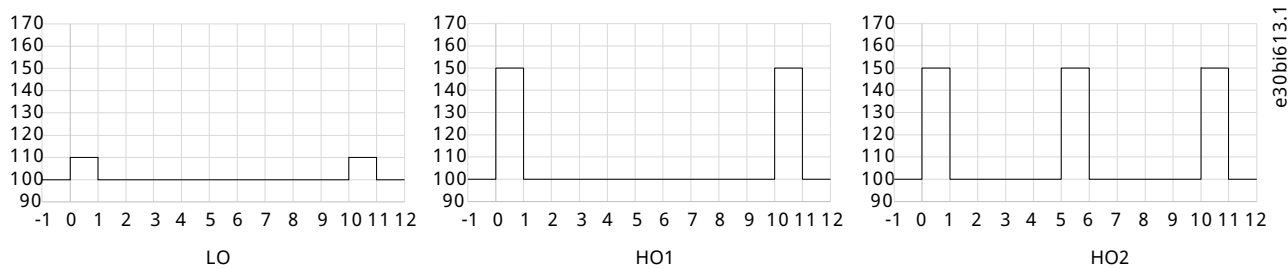

Figure 52: Overload Modes

Table 25: Selection Descriptions

Selection Name	Selection Description
Automatic Mode	Automatically switches between the modes Low Overload (LO) and High Overload (HO1).
Low Overload Mode (LO)	For applications running at a non-varying or slowly varying load, where a limited overload capability is required. This mode is typically used in applications with a variable torque load. The low overload profile allows the drive to run at 110% load for a minimum of 1 minute every 10 minutes. Typical applications where the low overload profile is used are: <ul style="list-style-type: none"> • Fans • Centrifugal pumps • Blowers and aerators • Screw compressors

Table 25: Selection Descriptions (continued)

Selection Name	Selection Description
High Overload Mode (HO1)	<p>For applications which require higher short-term overload and constant torque operations. Typical applications work with continuous motion. With high overload mode HO1, the drive can run with a load of up to 160% for 1 minute every 10 minutes, with a breakaway torque of up to 200%, depending on size. Typical applications where high overload HO1 is used are:</p> <ul style="list-style-type: none"> • Conveyors • Centrifuges • Decanters • Piston compressors • Piston pumps • Mixers • Stirrers • Escalators • Extruders (continuous running)
High Overload Mode (HO2)	<p>Used when the application has intermittent or continuous periodic duty. The resulting cyclic load requires more considerations on the use of the drive to ensure necessary performance and lifetime. Increased short-term starting torque is often also required. To benefit from the increased dynamic performance and not compromising lifetime, the output current is downrated by one motor size compared to HO1. With the high overload profile with increased duty, the drive can run with up to 160% load for 1 minute every 5 minutes, with a breakaway torque of up to 200%, depending on the current rating. Typical applications where the high overload profile with increased duty is used are:</p> <ul style="list-style-type: none"> • Extruders • Continuously accelerating conveyors • Lifts and hoists • Cranes • Positioning applications • Dosing pumps

6.3.3.3 Cooling Fan Control (Menu Index 2.2.2)

P 2.2.2.1 Main Fan Minimum Speed

Description: Set the minimum speed of the main cooling fan.

Default Value: 0	Parameter Type: Range (0 — 100)	Parameter Number: 2932
Unit: %	Data Type: REAL	Access Type: Read/Write

P 2.2.2.2 Internal Fan Minimum Speed

Description: Set the minimum speed of the internal cooling fan.

Default Value: 0	Parameter Type: Range (0 — 100)	Parameter Number: 2928
Unit: %	Data Type: REAL	Access Type: Read/Write

P 2.2.2.3 Main Fan Fail Response

Description: Select the drive response to a main fan fail.

Default Value: 3 [Warning]	Parameter Type: Selection	Parameter Number: 2939
Unit: -	Data Type: UINT	Access Type: Read/Write

The following are the selections for the parameter.

Selection Number	Selection Name	Selection Description
3	Warning	The drive issues a warning.
10	Fault	The drive issues a fault and coasts the motor.

P 2.2.2.4 Internal Fan Fail Response

Description: Select the drive response to an internal fan fail.

Default Value: 3 [Warning]	Parameter Type: Selection	Parameter Number: 2940
Unit: -	Data Type: UINT	Access Type: Read/Write

The following are the selections for the parameter.

Selection Number	Selection Name	Selection Description
3	Warning	The drive issues a warning.
10	Fault	The drive issues a fault and coasts the motor.

6.3.4 Protection (Menu Index 2.3)

6.3.4.1 Settings (Menu Index 2.3.1)

P 2.3.1.1 Retry after Fault

Description: Enables retry functionality (ride-through) after fault.

Default Value: 1 [Enabled]	Parameter Type: Selection	Parameter Number: 2927
Unit: -	Data Type: BOOL	Access Type: Read/Write

The following are the selections for the parameter.

Selection Number	Selection Name	Selection Description
0	Disabled	Disables the function.
1	Enabled	Enables the function.

P 2.3.1.2 Smart Derate Mode

Description: Select the level of derating if the drive's nominal operational limits have been exceeded.

Default Value: 0 [Maximum derating]	Parameter Type: Selection	Parameter Number: 2345
Unit: -	Data Type: UINT	Access Type: Read/Write

The following are the selections for the parameter.

Selection Number	Selection Name	Selection Description
0	Maximum derating	Drive derates as much as possible.
1	Minimum derating	Drive derates as little as possible.

P 2.3.1.3 DC-link Voltage Ripple Response

Description: Select the mode of excessive DC-link voltage ripple protection.

Default Value: 1 [Fault]	Parameter Type: Selection	Parameter Number: 2929
Unit: -	Data Type: UDINT	Access Type: Read/Write

The following are the selections for the parameter.

Selection Number	Selection Name	Selection Description
0	Disabled	Disables the protection.
1	Fault	The drive issues a fault if excessive DC-link voltage ripple is detected.

P 2.3.1.4 DC-link Imbalance Response

Description: Select a response to an imbalance across the DC-link capacitors' voltage.

Default Value: 10 [Fault]	Parameter Type: Selection	Parameter Number: 2346
Unit: -	Data Type: UINT	Access Type: Read/Write

The following are the selections for the parameter.

Selection Number	Selection Name	Selection Description
3	Warning	The drive issues a warning.
10	Fault	The drive issues a fault and coasts the motor.

P 2.3.1.5 Rectifier Thermal Overload Response

Description: Select the mode of rectifier thermal overload protection.

Default Value: 1 [Fault]	Parameter Type: Selection	Parameter Number: 2340
Unit: -	Data Type: UINT	Access Type: Read/Write

The following are the selections for the parameter.

Selection Number	Selection Name	Selection Description
1	Fault	The drive issues a fault and stops.
2	Automatically derate	The drive continues operation with derated performance.

P 2.3.1.6 Inverter Thermal Overload Response

Description: Select the mode of inverter thermal overload protection.

Default Value: 1 [Fault]	Parameter Type: Selection	Parameter Number: 2341
Unit: -	Data Type: UINT	Access Type: Read/Write

The following are the selections for the parameter.

Selection Number	Selection Name	Selection Description
1	Fault	The drive issues a fault and stops.
2	Automatically derate	The drive continues operation with derated performance.

P 2.3.1.7 Ground Fault 0 Response

Description: Select a response if a high-impedance ground fault occurs.

Default Value: 9 [Fault, ramp to coast]	Parameter Type: Selection	Parameter Number: 2347
Unit: -	Data Type: UINT	Access Type: Read/Write

The following are the selections for the parameter.

Selection Number	Selection Name	Selection Description
0	No response	The event is ignored.
9	Fault, ramp to coast	Issues a fault, ramps down, and coast.

P 2.3.1.8 Constant Loss Controller

Description: Enables the constant-loss controller. The function maintains a constant temperature in the drive at low-load conditions.

Default Value: 0	Parameter Type: Range (False — True)	Parameter Number: 2355
Unit: -	Data Type: BOOL	Access Type: Read/Write

6.3.4.2 Additional Information for Power Unit Protection Settings

P 2.3.1.1 Retry After Fault

This parameter enables the retry functionality (fault ride-through) after 1 of the common power conversion protections has activated. The number of retries or the retrying window depends on the power unit type and rating. The protections that can utilize retry are:

- Output current ground leakage fault
- Output overcurrent faults
- DC-link overvoltage and undervoltage faults
- Brake resistor or switching element short circuit faults

P 2.3.1.2 Smart Derate Mode

This parameter selects a level for the derating of the switching frequency whenever it is needed. The drive features multiple protection functions that can derate the switching frequency of the drive, to avoid operating conditions that are harmful for the drive. This parameter can be used to influence the degree of derating. Following are the descriptions of the selections for this parameter:

Table 26: Selection Descriptions

Selection Name	Selection Description
Maximum Derating Mode	When switching frequency derating is applied, the drive reduces the switching frequency to the maximum. This depends on the application scenario.
Minimum Derating Mode	When switching frequency derating is applied, the drive reduces the switching frequency to the minimum. This depends on the application scenario.

P 2.3.1.3 DC-link Voltage Ripple Response

This parameter selects a response for excessive DC-link voltage ripple protection. Excessive voltage ripples are detected when the peak-to-peak amplitude of the DC voltage exceeds the internal limit of the drive for a long period. Both the limit and time depend on the power unit type and rating. Following are the selection descriptions for the parameter:

Table 27: Selection Descriptions

Selection Name	Selection Description
Disabled	No action is undertaken when excessive rippling is detected.
Trip	After detecting excessive ripples for a long period, the drive issues a fault and performs stop modulation.

P 2.3.1.5 Rectifier Thermal Overload Response

This parameter selects a response to the reaction of the drive for rectifier thermal overload protection. Rectifier thermal overload is detected when the drive operates for a long period at a specified rectifier current level. Specific current levels and trip times depend on the power unit type and rating. Following are the descriptions for the selections available for the parameter:

Table 28: Selection Descriptions

Selection Name	Selection Description
Trip	The drive issues a fault and stops modulation.
Automatically derate	The drive derates the rectifier current (DC-link current) to mitigate the cause of rectifier thermal overload. When the drive exits from the overload operation window, derating is stopped.

P 2.3.1.6 Inverter Thermal Overload Response

This parameter selects a response to the reaction of the drive for Inverter Thermal Overload protection. Inverter thermal overload is detected when the drive operates for a long period at a specified output current level. Specific current levels and trip times depend on the power unit type and rating. Following are the descriptions for the selections available for the parameter:

Table 29: Selection Descriptions

Selection Name	Selection Description
Trip	The drive issues a fault and stops modulation.
Automatically derate	The drive derates the rectifier current (DC-link current) to mitigate the cause of rectifier thermal overload. When the drive exits from the overload operation window, derating is stopped.

6.3.4.3 Overvoltage Protection (Menu Index 2.3.2)

P 2.3.2.1 Overvoltage Control

Description: Enables the DC-link overvoltage controller. It is recommended to disable the overvoltage controller if brake is enabled, or the unit is supplied with a regulated DC.

Default Value: 1 [Enabled]	Parameter Type: Selection	Parameter Number: 1802
Unit: -	Data Type: BOOL	Access Type: Read/Write

The following are the selections for the parameter.

Selection Number	Selection Name	Selection Description
0	Disabled	Disables the function.
1	Enabled	Enables the function.

P 2.3.2.2 Overvoltage Control Kp

Description: Set the scaling of the overvoltage control proportional gain.

Default Value: 100	Parameter Type: Range (0 — 10000)	Parameter Number: 1803
Unit: %	Data Type: REAL	Access Type: Read/Write

P 2.3.2.3 Overvoltage Control Ti

Description: Set the scaling of the overvoltage control integral time.

Default Value: 100	Parameter Type: Range (0 — 10000)	Parameter Number: 1804
Unit: %	Data Type: REAL	Access Type: Read/Write

P 2.3.2.4 Overvoltage Control Td

Description: Set the scaling of the overvoltage control derivation time.

Default Value: 100	Parameter Type: Range (0 — 10000)	Parameter Number: 1805
Unit: %	Data Type: REAL	Access Type: Read/Write

P 2.3.2.5 Overvoltage Control Upper limit

Description: Set the upper limit for the overvoltage control. However, the voltage can be limited internally by the drive because of the available hardware, temperature, and time.

Default Value: 796.5	Parameter Type: Range (* — *)	Parameter Number: 1816
Unit: V	Data Type: REAL	Access Type: Read/Write

6.3.4.4 Additional Information for Overvoltage Protection

P 2.3.2.1 Overvoltage Control

Table 30: Selection Descriptions

Selection name	Selection description
Disable	<ul style="list-style-type: none"> The overvoltage controller does not affect motor speed in any manner. DC-link voltage is controlled with a brake chopper. <p> Note: A DC-link overvoltage fault is usually triggered when the DC-link voltage exceeds acceptable levels.</p>
Enable	When the DC-link voltage level exceeds the overvoltage level, motor speed or deceleration is limited by the controller.

6.3.4.5 Power Loss (Menu Index 2.3.3)

P 2.3.3.3 Power Loss Response

Description: Select the response to an insufficient supply voltage.

Default Value: 1 [Undervoltage control]	Parameter Type: Selection	Parameter Number: 1818
Unit: -	Data Type: UINT	Access Type: Read/Conditional Write

The following are the selections for the parameter.

Selection Number	Selection Name	Selection Description
0	None	The function is disabled.
1	Undervoltage control	Drive utilizes the kinetic energy in the system to maintain operation as long as possible.
2	Controlled ramp down	Drive utilizes the kinetic energy in the system to perform a controlled ramp down.
3	Coast	Drive coasts the motor.

P 2.3.3.4 Power Recovery Response

Description: Select the action to take when supply voltage returns after a power loss.

Default Value: 0 [Ramp to reference]	Parameter Type: Selection	Parameter Number: 1819
Unit: -	Data Type: UINT	Access Type: Read/Conditional Write

The following are the selections for the parameter.

Selection Number	Selection Name	Selection Description
0	Ramp to reference	Drive ramps to reference.
1	Ramp fast to reference	Drive ramps as fast as possible to reference.
2	Ramp to zero	Drive ramps down and coasts.

P 2.3.3.5 Undervoltage Control Kp

Description: Set the scaling of the undervoltage control proportional gain.

Default Value: 100	Parameter Type: Range (0.001 — 10000)	Parameter Number: 1806
Unit: %	Data Type: REAL	Access Type: Read/Write

P 2.3.3.6 Undervoltage Control Ti

Description: Set the scaling of the undervoltage control integral time.

Default Value: 100	Parameter Type: Range (0 — 10000)	Parameter Number: 1807
Unit: %	Data Type: REAL	Access Type: Read/Write

P 2.3.3.7 Undervoltage Control Td

Description: Set the scaling of the undervoltage control derivation time.

Default Value: 100	Parameter Type: Range (0 — 10000)	Parameter Number: 1808
Unit: %	Data Type: REAL	Access Type: Read/Write

P 2.3.3.8 Undervoltage Control Activation Level

Description: Set the level at which undervoltage control is activated.

Default Value: 100	Parameter Type: Range (* — *)	Parameter Number: 1817
Unit: V	Data Type: REAL	Access Type: Read/Write

P 2.3.3.12 Deceleration Time Power Loss

Description: Set the deceleration time from nominal speed to 0 when in power-loss mode.

Default Value: 0.5	Parameter Type: Range (0.02 — 10000)	Parameter Number: 1139
Unit: s	Data Type: REAL	Access Type: Read/Write

6.3.4.6 Additional Information for Power Loss

P 2.3.3.3 Power Loss Response

This parameter sets the reaction of the drive when the drive has insufficient supply voltage (DC-link voltage). Insufficient voltage is detected when the actual voltage falls below the undervoltage limit.

Table 31: Selection Descriptions

Selection name	Selection description
None	During a power loss scenario, the drive takes no action. The undervoltage controlled is disabled.
Undervoltage control	<ul style="list-style-type: none"> When the voltage falls below the undervoltage level, the undervoltage controller is activated. The controller decelerates the motor speed to regenerate energy to DC-link. Use this selection for system module drives.
Controlled Ramp Down	When the voltage falls below the undervoltage level, the drive stops by ramping the motor speed to zero before stopping modulation.
Coast	When the voltage falls below the undervoltage level, the drive immediately stops modulating.

P 2.3.3.4 Power Recovery Response

Sets the reaction of the drive when the supply voltage (DC-link voltage) returns after a power loss event. The reaction occurs when the actual voltage returns and exceeds the undervoltage limit.

Table 32: Selection Descriptions

Selection name	Selection description
Ramp to Reference	This is the recommended selection for a system drive. The drive ramps from the actual speed to the reference.
Ramp Fast to Reference	The drive bypasses ramping and operates directly with the reference.  Note: This selection is only available with the flux motor control principle.

6.3.5 Modulation (Menu Index 2.4)

P 2.4.1 Max. Switching Frequency

Description: Set the maximum switching frequency.

Default Value: 16.00	Parameter Type: Range (* — *)	Parameter Number: 2924
Unit: kHz	Data Type: REAL	Access Type: Read/Write

P 2.4.2 Min. Switching Frequency

Description: Set the minimum switching frequency.

Default Value: 1.00	Parameter Type: Range (* — *)	Parameter Number: 2925
Unit: kHz	Data Type: REAL	Access Type: Read/Write

P 2.4.3 Switching Frequency

Description: Set the switching frequency.

Default Value: 1.00	Parameter Type: Range (* — *)	Parameter Number: 2920
Unit: kHz	Data Type: REAL	Access Type: Read/Write

P 2.4.4 Control Frequency Request

Description: Set the requested control frequency. A constant control frequency is enabled by setting this value. If set to 0.0, constant control frequency is disabled.

Default Value: 0.00	Parameter Type: Range (0.00 — 16.00)	Parameter Number: 2921
Unit: kHz	Data Type: REAL	Access Type: Read/Conditional Write

P 2.4.6 Overmodulation

Description: Enables the modulation index to exceed 1.0.

Default Value: 1 [Enabled]	Parameter Type: Selection	Parameter Number: 5094
Unit: -	Data Type: BOOL	Access Type: Read/Write

The following are the selections for the parameter.

Selection Number	Selection Name	Selection Description
0	Disabled	Disables the function.
1	Enabled	Enables the function.

6.4 Filters & Brake Chopper (Menu Index 3)

6.4.1 Filters & Brake Chopper Overview

This parameter group contains parameters for configuring, monitoring, and controlling the input filters, output filters, brake chopper, and brake resistors.

6.4.2 Filters & Brake Chopper Status (Menu Index 3.1)

P 3.1.1 Brake Power

Description: Shows the power dissipated in the brake resistor.

Default Value: NA	Parameter Type: Range (0.00 — *)	Parameter Number: 2933
Unit: kW	Data Type: REAL	Access Type: Read Only

P 3.1.2 Average Brake Power

Description: Shows the average power dissipated in the brake resistor, calculated over 120 s.

Default Value: NA	Parameter Type: Range (0.00 — *)	Parameter Number: 2934
Unit: kW	Data Type: REAL	Access Type: Read Only

P 3.1.3 AHF Capacitor Connected

Description: Shows if the advanced harmonic filter (AHF) capacitor is connected.

Default Value: NA	Parameter Type: Range (0 — 1)	Parameter Number: 5410
Unit: -	Data Type: BOOL	Access Type: Read Only

6.4.3 Brake Chopper (Menu Index 3.2)

P 3.2.1 Brake Chopper

Description: Select the brake chopper operation mode.

Default Value: 0 [Disabled]	Parameter Type: Selection	Parameter Number: 2935
Unit: -	Data Type: UINT	Access Type: Read/Write

The following are the selections for the parameter.

Selection Number	Selection Name	Selection Description
0	Disabled	
1	Enabled in Run and Coast	Enables the brake chopper both while running and at coast.
2	Enabled in run only	Enables the brake chopper while running.

P 3.2.2 Brake Chopper Voltage Reduce

Description: Set the activation level of the brake chopper. If set to 0, the brake chopper is active if the voltage exceeds the overvoltage control activation level. The value set is subtracted from the overvoltage control activation level, lowering the brake chopper activation level, respectively.

Default Value: 0	Parameter Type: Range (0 — 50)	Parameter Number: 2938
Unit: V	Data Type: REAL	Access Type: Read/Write

6.4.4 Brake Resistor (Menu Index 3.3)

P 3.3.1 Brake Resistor Test

Description: Enables the brake resistor test. The drive conducts a test of brake resistor presence while the drive is coasted. Starting of the drive is prohibited until the test is completed.

Default Value: NA	Parameter Type: Selection	Parameter Number: 430
Unit: -	Data Type: UINT	Access Type: Read/Conditional Write

The following are the selections for the parameter.

Selection Number	Selection Name	Selection Description
0	Off	
1	Enable brake chopper test run	Executes a test of the brake chopper and brake resistor to check if they are operational.

P 3.3.2 Brake Resistor Resistance

Description: Set the resistance value of the brake resistor.

Default Value: 5	Parameter Type: Range (* — *)	Parameter Number: 2936
Unit: Ω	Data Type: REAL	Access Type: Read/Conditional Write

P 3.3.3 Brake Resistor Power Limit

Description: Set the power limit for resistor braking.

Default Value: 1	Parameter Type: Range (0 — *)	Parameter Number: 2937
Unit: kW	Data Type: REAL	Access Type: Read/Write

6.4.5 Additional Information for Brake Resistor

P 3.3.3 Brake Resistor Power Limit

The parameter must be configured to set the expected average power dissipated in the brake resistor over a period of 120 s. To calculate the brake resistor power limit, use the following formula.

$$P_{br, avg}(W) = \frac{U_{br}^2 \times t_{br}(s)}{R_{br}(\Omega) \times T_{br}(s)}$$

The following elements are used in the formula:

- $P_{br, avg}$ is the average power dissipated in the brake resistor.
- R_{br} is the resistance of the brake resistor.
- t_{br} is the active braking time within 120 s. (T_{br}).
- U_{br} is the DC link when the brake chopper is active. The correct value depends on the selection of parameter **2.2.1 Unit Voltage Class** using the following table.

Table 33: Power rating and voltage class setting

Voltage range	Unit voltage class 380–500 V AC (3N05)
Low voltage range	705
Medium voltage range	770
High voltage range (low brake level)	780
High voltage range (high brake level)	800

6.4.6 Advanced Harmonic Filter (Menu Index 3.4)

P 3.4.1 Advanced Harmonic Filter

Description: Select if the Advanced Harmonic Filter is connected to the drive.

Default Value: 0 [Disabled]	Parameter Type: Selection	Parameter Number: 3410
Unit: -	Data Type: BOOL	Access Type: Read/Write

The following are the selections for the parameter.

Selection Number	Selection Name	Selection Description
0	Disabled	Disables the function.
1	Enabled	Enables the function.

P 3.4.2 Capacitor Disconnect Output

Description: Select the output terminal for disconnecting the capacitor.

Default Value:	Parameter Type: Selection	Parameter Number: 3412
Unit: -	Data Type: UINT	Access Type: Read/Write

P 3.4.3 Thermal Switch Response

Description: Select which function is activated if the thermal input indicates too high a temperature.

Default Value: 1 [Fault, ramp to coast]	Parameter Type: Selection	Parameter Number: 3413
Unit: -	Data Type: UINT	Access Type: Read/Write

The following are the selections for the parameter.

Selection Number	Selection Name	Selection Description
1	Fault, ramp to coast	Issues a fault, ramps down, and coast.
2	Derate	The drive issues a fault, continues operation, and derates to protect the filter.

P 3.4.4 Thermal Switch Input

Description: Select the digital input terminal for the thermal switch.

Default Value:	Parameter Type: Selection	Parameter Number: 3414
Unit: -	Data Type: UINT	Access Type: Read/Write

P 3.4.5 Power Stabilizer Gain

Description: Set the controller gain for power stabilization. The power stabilizer dampens possible resonance with the grid. If set to -1 the value is selected automatically, if set to 0 the controller is disabled.

Default Value: -1	Parameter Type: Range (-1 — 500)	Parameter Number: 3415
Unit: %	Data Type: REAL	Access Type: Read/Write

P 3.4.6 Power Stabilizer Bandwidth

Description: Set the controller bandwidth for power stabilization.

Default Value: 100	Parameter Type: Range (1 — 10000)	Parameter Number: 3416
Unit: %	Data Type: REAL	Access Type: Read/Write

6.4.7 Output Filter (Menu Index 3.5)

P 3.5.1 Output Filter Type

Description: Select the output filter type.

Default Value: 0 [None]	Parameter Type: Selection	Parameter Number: 5501
Unit: -	Data Type: UINT	Access Type: Read/Conditional Write

The following are the selections for the parameter.

Selection Number	Selection Name	Selection Description
0	None	No output filter connected.
1	Sine-wave Filter	Sine-wave filter connected.

P 3.5.2 Filter Capacitance

Description: Set the capacitance of the output filter.

Default Value: *	Parameter Type: Range (0.00 — 1000000.00)	Parameter Number: 5502
Unit: µF	Data Type: REAL	Access Type: Read/Conditional Write

P 3.5.3 Filter Inductance

Description: Set the inductance of the output filter.

Default Value: *	Parameter Type: Range (0.00 — 1000.00)	Parameter Number: 5503
Unit: mH	Data Type: REAL	Access Type: Read/Conditional Write

6.4.8 Additional Information for Output Filter

P 3.5.2 Filter Capacitance

Set the C_y (capacitance) value of the output filter. See the filter product label for the capacitance value. The value is the equivalent star-connected capacitance of the filter. When the filters are installed in parallel, enter the combined capacitance value of the paralleled filter. The value is the equivalent star-connected capacitance (C_y) of the filter multiplied by the number of installed paralleled filters.

P 3.5.3 Filter Inductance

Set the inductance of the output filter. See the product label of the filter for the value of inductance. When filters are installed in parallel, enter the combined inductance value of the installed paralleled filters. The inductance value in the parameter is the inductance value of the filter divided by the number of paralleled filters.

6.5 Motor (Menu Index 4)

6.5.1 Motor Overview

This parameter group contains parameters for configuring the motor, motor control, and motor protection.

6.5.2 Motor Status (Menu Index 4.1)

P 4.1.1 Motor Current

Description: Shows the actual motor current.

Default Value: NA	Parameter Type: Range (0 — *)	Parameter Number: 9000
Unit: A	Data Type: REAL	Access Type: Read Only

P 4.1.2 Relative Motor Current

Description: Shows the actual motor current in % of the nominal motor current.

Default Value: NA	Parameter Type: Range (0 — 200)	Parameter Number: 9001
Unit: %	Data Type: REAL	Access Type: Read Only

P 4.1.3 U-phase RMS Current

Description: Shows the U-phase RMS current.

Default Value: NA	Parameter Type: Range (0 — *)	Parameter Number: 9020
Unit: A	Data Type: REAL	Access Type: Read Only

P 4.1.4 V-phase RMS Current

Description: Shows the V-phase RMS current.

Default Value: NA	Parameter Type: Range (0 — *)	Parameter Number: 9021
Unit: A	Data Type: REAL	Access Type: Read Only

P 4.1.5 W-phase RMS Current

Description: Shows the W-phase RMS current.

Default Value: NA	Parameter Type: Range (0 — *)	Parameter Number: 9022
Unit: A	Data Type: REAL	Access Type: Read Only

P 4.1.6 Motor Voltage

Description: Shows the actual motor voltage.

Default Value: NA	Parameter Type: Range (0 — *)	Parameter Number: 9005
Unit: V	Data Type: REAL	Access Type: Read Only

P 4.1.7 Relative Motor Voltage

Description: Shows the actual motor voltage in % of the nominal motor voltage.

Default Value: NA	Parameter Type: Range (0 — 200)	Parameter Number: 9006
Unit: %	Data Type: REAL	Access Type: Read Only

P 4.1.11 Motor Torque

Description: Shows the actual motor torque.

Default Value: NA	Parameter Type: Range (-10000000 — 10000000)	Parameter Number: 9009
Unit: Nm	Data Type: REAL	Access Type: Read Only

P 4.1.12 Relative Motor Torque

Description: Shows the motor torque in % of the nominal motor torque.

Default Value: NA	Parameter Type: Range (* — *)	Parameter Number: 1708
Unit: %	Data Type: REAL	Access Type: Read Only

P 4.1.13 Motor Shaft Power

Description: Shows the actual power at the motor shaft.

Default Value: NA	Parameter Type: Range (* — *)	Parameter Number: 9008
Unit: kW	Data Type: REAL	Access Type: Read Only

P 4.1.14 Relative Motor Shaft Power

Description: Shows the actual motor shaft power in % of the nominal motor shaft power.

Default Value: NA	Parameter Type: Range (-300 — 300)	Parameter Number: 1707
Unit: %	Data Type: REAL	Access Type: Read Only

P 4.1.15 Motor Electrical Power

Description: Shows the actual motor power.

Default Value: NA	Parameter Type: Range (* — *)	Parameter Number: 9043
Unit: kW	Data Type: REAL	Access Type: Read Only

P 4.1.16 Motor Thermal Load (ETR)

Description: Shows the estimated thermal load of the motor calculated by the ETR function.

Default Value: NA	Parameter Type: Range (0 — 100)	Parameter Number: 2951
Unit: %	Data Type: REAL	Access Type: Read Only

P 4.1.17 Motor Current Output

Description: Select an output for the motor current signal. The scale of the signal is 0–100% of the nominal current.

Default Value:	Parameter Type: Selection	Parameter Number: 2302
Unit: -	Data Type: UINT	Access Type: Read/Write

P 4.1.18 Motor Voltage Output

Description: Select an output for the motor voltage signal. The scale of the signal is 0–100% of the nominal voltage.

Default Value:	Parameter Type: Selection	Parameter Number: 2303
Unit: -	Data Type: UINT	Access Type: Read/Write

P 4.1.19 Absolute Motor Torque Output

Description: Select an output for the motor torque signal. The scale of the signal is 0–100% of the absolute value of the nominal torque.

Default Value:	Parameter Type: Selection	Parameter Number: 2306
Unit: -	Data Type: UINT	Access Type: Read/Write

P 4.1.20 Extended Motor Torque Output

Description: Select an output for the motor torque signal. The scale of the signal is -200...200% of the nominal torque.

Default Value:	Parameter Type: Selection	Parameter Number: 2310
Unit: -	Data Type: UINT	Access Type: Read/Write

P 4.1.21 Absolute Motor Speed Output

Description: Select an output for the motor speed signal. The scale of the signal is 0–100% of the absolute value of the nominal speed.

Default Value:	Parameter Type: Selection	Parameter Number: 2301
Unit: -	Data Type: UINT	Access Type: Read/Write

P 4.1.22 Extended Motor Speed Output

Description: Select an output for the motor speed signal. The scale of the signal is -200...200% of the nominal speed.

Default Value:	Parameter Type: Selection	Parameter Number: 2309
Unit: -	Data Type: UINT	Access Type: Read/Write

P 4.1.23 Motor Power Output

Description: Select an output for the motor power signal. The scale of the signal is 0–100% of the nominal power.

Default Value:	Parameter Type: Selection	Parameter Number: 2305
Unit: -	Data Type: UINT	Access Type: Read/Write

P 4.1.24 AMA Progress

Description: Shows the progress of the Automatic Motor Adaptation (AMA).

Default Value: NA	Parameter Type: Range (0 — 100)	Parameter Number: 429
Unit: %	Data Type: REAL	Access Type: Read Only

P 4.1.26 Motor Temperature

Description: The analog temperature sensor has exceeded the configured value.

Default Value: NA	Parameter Type: Range (-300 — 300)	Parameter Number: 1630
Unit: °C	Data Type: REAL	Access Type: Read Only

P 4.1.28 Rs Measured

Description: When a Rs measurement has been stored for use after drive power recycle, the value is shown here; otherwise it is zero.

Default Value:	Parameter Type: Range (0 — 1000000)	Parameter Number: 433
Unit: Ω	Data Type: REAL	Access Type: Read/Write

6.5.3 Motor Data (Menu Index 4.2)

6.5.3.1 General Settings (Menu Index 4.2.1)

P 4.2.1.1 Motor Type

Description: Select the motor type.

Default Value: 0 [Induction Motor]	Parameter Type: Selection	Parameter Number: 407
Unit: -	Data Type: UINT	Access Type: Read/Conditional Write

The following are the selections for the parameter.

Selection Number	Selection Name	Selection Description
0	Induction Motor	Asynchronous Induction Motor.
1	Permanent Magnet Motor	Permanent Magnet Motor.

P 4.2.1.2 Number of Pole Pairs

Description: Set the number of pole pairs. For example, a 4-pole motor is set as 2 pole pairs.

Default Value: 2	Parameter Type: Range (0 — 65535)	Parameter Number: 406
Unit: -	Data Type: UINT	Access Type: Read/Conditional Write

P 4.2.1.3 AMA Mode

Description: Select the Automatic Motor Adaptation (AMA) mode.

Default Value: 0 [Off]	Parameter Type: Selection	Parameter Number: 420
Unit: -	Data Type: UINT	Access Type: Read/Conditional Write

The following are the selections for the parameter.

Selection Number	Selection Name	Selection Description
0	Off	AMA is disabled for normal operation.
3	Motor Data	The next start command initiates measurement of the motor data.
4	Reduced Motor Data (Rs)	The next start command initiates measurement of the motor stator resistance - Rs.

P 4.2.1.4 Rs Measurement at start

Description: Determine when a Rs measurement is performed.

Default Value: 0 [Off]	Parameter Type: Selection	Parameter Number: 432
Unit: -	Data Type: UINT	Access Type: Read/Write

The following are the selections for the parameter.

Selection Number	Selection Name	Selection Description
0	Off	Select this setting to disable Rs measurement. To reset the triggering, this setting has to be selected in between the other methods.
1	First start after power on	Select performing a Rs measurement at the first start after the drive is powered on.
2	Every start	A Rs measurement is performed before every start.
3	First start with store	Enable performing a Rs measurement at the first start. The measurement is stored.

P 4.2.1.5 Motor Cable Length

Description: Set the motor cable length.

Default Value: 100	Parameter Type: Range (0 — 10000)	Parameter Number: 425
Unit: m	Data Type: REAL	Access Type: Read/Conditional Write

P 4.2.1.6 Output Phase Sequence

Description: Set the output phase sequence. This function virtually swaps the output phases, which can be used to change the direction of motor rotation without having to physically rewire motor cables.

Default Value: 0 [UVW]	Parameter Type: Selection	Parameter Number: 431
Unit: -	Data Type: UINT	Access Type: Read/Conditional Write

The following are the selections for the parameter.

Selection Number	Selection Name	Selection Description
0	UVW	Select the normal phase sequence.
1	WVU	Select the reverse phase sequence.

6.5.3.2 Additional Information for Motor Data General Settings

P 4.2.1.2 Number of Pole Pairs

The synchronous speed of a motor can be calculated when the supply frequency and number of pole pairs are known. The formula to calculate the synchronous speed of the motor (n_s) with supply frequency (f) and number of pole pairs (p) is as follows:

$$n_s = \frac{60 \times f}{p} \text{ [RPM]}$$

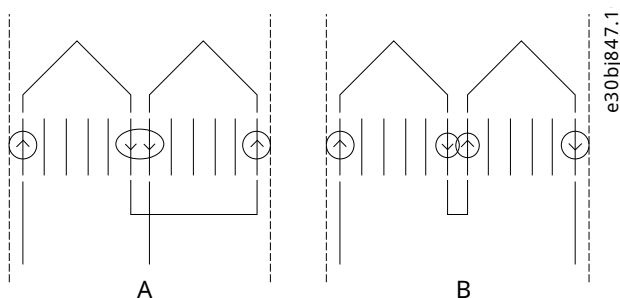

Figure 53: Two Inductors in 1 Phase Connected in Series to A) 2 Poles B) 4 Poles

While the frequency is determined by the grid or the AC drive, the number of poles is determined by the way the stator inductors are connected. Pole pairs (p) or pole number and synchronous motor speed lists the number of poles corresponding to synchronous speed (n_0) at 50 Hz and 60 Hz supply.

Table 34: Number of Pole Pairs (p) and Nominal Speed ($\sim nn$) for Motors @ 50 Hz and 60 Hz

Number of pole pairs (p)	$\sim nn$ @ 50 Hz	$\sim nn$ @ 60 Hz
1	2700–2880	3250–3460
2	1350–1450	1625–1730
3	700–960	840–1153

Table 35: Pole Pairs (p) or Pole Number and Synchronous Motor Speed

Number of pole pairs (p)	1	2	3	4	6
Number of poles	2	4	6	8	12
50 Hz supply	3000	1500	1000	750	500
60 Hz supply	3600	1800	1200	900	600

The dependency of the motor's synchronous speed n_s in RPM of the frequency f of the power supply in Hz (parameter **1.1.1 Grid Frequency**) and the number of pole pairs in parameter **4.2.1.2 Number of Pole Pairs** is provided by the earlier formula.

For example, for a motor with 2 pole pairs (4 poles) and a frequency of the power supply of 50 Hz, the synchronous speed of the motor is:

$$n_s = \frac{60 \times f}{p} [\text{RPM}] = 1500 \text{RPM}$$

P 4.2.1.3 AMA Mode

Automatic Motor Adaptation (AMA) is an automated test procedure providing an optimization of the motor parameters for improved shaft performance. The measurement is performed based on the motor product label data in parameter group **4.2.2 Motor Nameplate Data**. The motor-type-specific parameters in parameter group **4.2.3 Induction Motor** or parameter group **4.2.4 Permanent Magnet Motor** are recalculated and used to fine-tune the motor control algorithm. Running the AMA procedure also maximizes the automatic energy optimization (AEO) feature of the drive. AMA also allows the automatic detection of the motor type based on the product label data.

- The AMA must be run on a cold motor. Running the AMA multiple times also increases the motor temperature.
- The AMA must be conducted with the motor at standstill.
- Avoid generating external torque during AMA.
- The AMA cannot run with a sine-wave filter connected.
- Uncoupling the load from the motor is not needed.
- The duration of the AMA depends on the power rating of the motor.
- Changing the product label data in parameter group **4.2.2 Motor Nameplate Data** also modifies the data in the parameter group **4.2.3 Induction Motor** or **4.2.4 Permanent Magnet Motor**.



Note: The parameter automatically switches back to Off after the AMA has been performed.

4.2.1.4 Rs Measurement at Start

Use R_s measurement at start to measure the resistance of the stator (R_s) before motor start, for induction and permanent magnet motors running FVC+. For induction motors, the rotor resistance (R_r) is also provided.

Accurate motor parameters are important for optimum motor performance, and measuring resistances before starting the motor can help compensate for variation caused by changes in motor operating temperature.

It is important that the shaft is not rotating when the measurement is made. If it cannot be guaranteed, use DC hold to stop the shaft before start.

P 4.2.1.5 Motor Cable Length

In some products, depending on the EMC configuration, this parameter may adjust the allowable switching frequency automatically to achieve optimum performance of the drive system.

Depending on whether metric or imperial units are in use, give the value for the parameter in either meters (m) or feet (ft). The value range is different with the different units.

6.5.3.3 Overview of Motor Nameplate Data

These parameters allow the setting of motor nameplate data.

Often, permanent magnet motors have torque but not power given on the motor nameplate. For those motors, set the speed and torque product label settings, then the system calculates the power value. The system also calculates the torque value for asynchronous motors, when the power and speed values are set.

When a higher priority parameter is set, the value of the lower priority parameter is calculated by the system. The parameters have the following priority order:

1. Nominal Power
2. Nominal Speed
3. Nominal Torque

To calculate the nominal torque of the motor, first set nominal power and then nominal speed.

To calculate nominal power of the motor, first set nominal speed and then nominal torque.

6.5.3.4 Motor Nameplate Data (Menu Index 4.2.2)

P 4.2.2.1 Nominal Power

Description: Set the nominal motor shaft power.

Default Value: 5.50	Parameter Type: Range (* — *)	Parameter Number: 405
Unit: kW	Data Type: REAL	Access Type: Read/Conditional Write

P 4.2.2.2 Nominal Current

Description: Set the nominal motor current.

Default Value: 11.5	Parameter Type: Range (* — *)	Parameter Number: 400
Unit: A	Data Type: REAL	Access Type: Read/Conditional Write

P 4.2.2.3 Nominal Speed

Description: Set the nominal motor shaft speed.

Default Value: 1450	Parameter Type: Range (0 — 100000)	Parameter Number: 402
Unit: rpm	Data Type: REAL	Access Type: Read/Conditional Write

P 4.2.2.4 Nominal Frequency

Description: Set the nominal motor frequency.

Default Value: 50	Parameter Type: Range (0 — 2000)	Parameter Number: 403
Unit: Hz	Data Type: REAL	Access Type: Read/Conditional Write

P 4.2.2.5 Nominal Voltage

Description: Set the nominal motor voltage.

Default Value: 400	Parameter Type: Range (* — *)	Parameter Number: 401
Unit: V	Data Type: REAL	Access Type: Read/Conditional Write

P 4.2.2.6 Nominal Torque

Description: Set the nominal torque from the nameplate of the motor.

Default Value: 52521.13	Parameter Type: Range (* — *)	Parameter Number: 9951
Unit: NomTorqueSI	Data Type: REAL	Access Type: Read/Conditional Write

6.5.3.5 Induction Motor (Menu Index 4.2.3)

P 4.2.3.1 Stator Resistance Rs

Description: Set the motor stator resistance. Overwritten by AMA.

Default Value: 1.21	Parameter Type: Range (0 — 1000000)	Parameter Number: 408
Unit: Ω	Data Type: REAL	Access Type: Read/Conditional Write

P 4.2.3.2 Rotor Resistance Rr

Description: Set the motor rotor resistance. Overwritten by AMA.

Default Value: 0.79	Parameter Type: Range (0 — 1000000)	Parameter Number: 409
Unit: Ω	Data Type: REAL	Access Type: Read/Conditional Write

P 4.2.3.3 Iron Loss Resistance Rfe

Description: Set the motor iron-loss equivalent resistance.

Default Value: 874	Parameter Type: Range (0 — 11000000000)	Parameter Number: 413
Unit: Ω	Data Type: REAL	Access Type: Read/Conditional Write

P 4.2.3.4 Stator Leakage Reactance Xls

Description: Set the motor stator leakage reactance. Overwritten by AMA.

Default Value: 0.03	Parameter Type: Range (0.00 — 62.83)	Parameter Number: 440
Unit: Ω	Data Type: REAL	Access Type: Read/Conditional Write

P 4.2.3.5 Rotor Leakage Reactance Xlr

Description: Set the motor rotor leakage reactance. Overwritten by AMA.

Default Value: 0.03	Parameter Type: Range (0.00 — 62.83)	Parameter Number: 441
Unit: Ω	Data Type: REAL	Access Type: Read/Conditional Write

P 4.2.3.6 Magnetizing Reactance Xm

Description: Set the motor magnetizing reactance. Overwritten by AMA.

Default Value: 0.94	Parameter Type: Range (0.00 — 62.83)	Parameter Number: 442
Unit: Ω	Data Type: REAL	Access Type: Read/Conditional Write

6.5.3.6 Additional Information for Induction Motor

P 4.2.3.2 Rotor Resistance Rr

Use any of the following methods for setting Rr:

- Run an AMA on a cold motor. The drive measures the value from the motor. All compensations are reset to 100%.
- Enter the Rr value manually. Obtain the value from the motor supplier.
- Use the Rr default setting. The drive establishes the setting based on the motor nameplate data.

P 4.2.3.3 Iron Loss Resistance Rfe

The RFe value cannot be found by performing an AMA. The RFe value is especially important in torque control applications. If RFe is unknown, make sure to keep the default setting of the parameter.

P 4.2.3.4 Stator Leakage Reactance Xls

Use any of the following methods for setting Xls:

- Run an AMA on a cold motor. The drive measures the value from the motor.
- Enter the Xls value manually. Obtain the value from the motor supplier.
- Use the Xls default setting. The drive establishes the setting based on the motor nameplate data.

P 4.2.3.5 Rotor Leakage Reactance Xlr

Use any of the following methods to set Xlr:

- Run an AMA on a cold motor. The drive measures the value from the motor.
- Enter the Xlr value manually. Obtain the value from the motor supplier.
- Use the Xlr default setting. The drive establishes the setting based on the motor nameplate data.

6.5.3.7 Permanent Magnet Motor (Menu Index 4.2.4)

P 4.2.4.1 Back EMF

Description: Set the stator nominal induced voltage (back-EMF voltage) when running at 1000 RPM (line-to-line RMS). Overwritten by AMA.

Default Value: 190	Parameter Type: Range (0 — 10000)	Parameter Number: 415
Unit: V	Data Type: REAL	Access Type: Read/Conditional Write

P 4.2.4.2 Stator Resistance Rs

Description: Set the motor stator resistance. Overwritten by AMA.

Default Value: 1.21	Parameter Type: Range (0 — 1000000)	Parameter Number: 408
Unit: Ω	Data Type: REAL	Access Type: Read/Conditional Write

P 4.2.4.3 d-axis Inductance Ld

Description: Set the motor non-saturated d-axis inductance. Overwritten by AMA.

Default Value: 23.00	Parameter Type: Range (0.00 — 1000.00)	Parameter Number: 417
Unit: mH	Data Type: REAL	Access Type: Read/Conditional Write

P 4.2.4.4 d-axis Inductance LdSat

Description: Set the motor saturated d-axis inductance. Overwritten by AMA.

Default Value: 23.00	Parameter Type: Range (0.00 — 1000.00)	Parameter Number: 418
Unit: mH	Data Type: REAL	Access Type: Read/Conditional Write

P 4.2.4.5 Ld Saturation Point

Description: Set the point (in % of nominal motor current) at which the Ld inductance saturates (average of non-saturated and saturated). Overwritten by AMA.

Default Value: 100	Parameter Type: Range (0 — 300)	Parameter Number: 426
Unit: %	Data Type: REAL	Access Type: Read/Conditional Write

P 4.2.4.6 q-axis Inductance Lq

Description: Set the motor non-saturated q-axis inductance. Overwritten by AMA.

Default Value: 85.00	Parameter Type: Range (0.00 — 1000.00)	Parameter Number: 427
Unit: mH	Data Type: REAL	Access Type: Read/Conditional Write

P 4.2.4.7 q-axis Inductance LqSat

Description: Set the motor saturated q-axis inductance. Overwritten by AMA.

Default Value: 85.00	Parameter Type: Range (0.00 — 1000.00)	Parameter Number: 422
Unit: mH	Data Type: REAL	Access Type: Read/Conditional Write

P 4.2.4.8 Lq Saturation Point

Description: Set the point (in % of nominal motor current) at which the Lq inductance saturates (average of non-saturated and saturated). Overwritten by AMA.

Default Value: 100	Parameter Type: Range (0 — 300)	Parameter Number: 424
Unit: %	Data Type: REAL	Access Type: Read/Conditional Write

6.5.4 Motor Control (Menu Index 4.3)

6.5.4.1 General Settings (Menu Index 4.3.1)

P 4.3.1.1 Motor Control Principle

Description: Select the motor control principle.

Default Value: 1 [VVC+ Control]	Parameter Type: Selection	Parameter Number: 2503
Unit: -	Data Type: UINT	Access Type: Read/Conditional Write

The following are the selections for the parameter.

Selection Number	Selection Name	Selection Description
0	U/f Control	Selects U/f control as motor control.
1	VVC+ Control	Selects Voltage Vector Control (VVC+) as motor control.
2	FVC+ Control	Selects Flux Vector Control (FVC+) as motor control.

P 4.3.1.2 Breakaway Current Boost

Description: Enables the breakaway current boost, which temporarily allows a higher starting current.

Default Value: 0 [Disabled]	Parameter Type: Selection	Parameter Number: 2930
Unit: -	Data Type: BOOL	Access Type: Read/Write

The following are the selections for the parameter.

Selection Number	Selection Name	Selection Description
0	Disabled	Disables the function.
1	Enabled	Enables the function.

P 4.3.1.5 Motor Feedback Mode

Description: Select the feedback mode.

Default Value: 0 [Open loop]	Parameter Type: Selection	Parameter Number: 2502
Unit: -	Data Type: UINT	Access Type: Read/Write

The following are the selections for the parameter.

Selection Number	Selection Name	Selection Description
0	Open loop	The motor is operated without feedback. The motor control estimates the actual speed.
1	Closed loop with Feedback Device 1	The motor is operated with feedback, providing speed and position feedback for motor control from feedback device 1.
2	Closed loop with Feedback Device 2	The motor is operated with feedback, providing speed and position feedback for motor control from feedback device 2.

P 4.3.1.6 Motor Feedback Test Mode

Description: Select the motor feedback test mode.

Default Value: 0 [Off]	Parameter Type: Selection	Parameter Number: 421
Unit: -	Data Type: UINT	Access Type: Read/Conditional Write

The following are the selections for the parameter.

Selection Number	Selection Name	Selection Description
0	Off	Motor feedback test is not enabled.
1	Enable Motor Feedback Test	The next start command initiates test of motor feedback signal.

6.5.4.2 Running a Motor Feedback Test

The Motor Feedback Test optimizes closed-loop motor operation. During the test, the motor is rotated in open loop and feedback data is gathered. The feedback data is then utilized in closed-loop operation.

The Motor Feedback Test is executed during commissioning.

1. Set parameter 4.3.1.6 *Motor Feedback Test Mode* to *Enable Motor Feedback Test*.

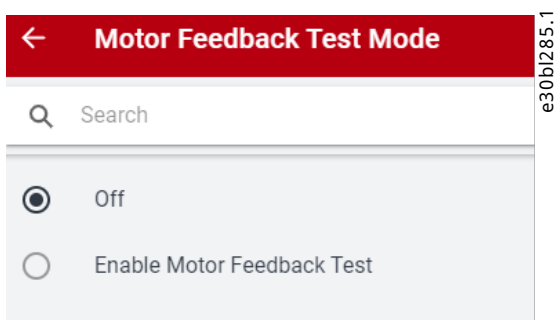

Figure 54: Motor Feedback Test Mode in MyDrive® Insight

➡ The warning *Feedback Test Active (5600)* is issued, and normal start is suppressed until the test is executed.

2. Give the start command.

➤ The motor accelerates to 60 RPM and runs for 1 second. The test samples the feedback signal. The motor stops after 1 second and the drive reports the test result. Parameter **4.3.1.6 Motor Feedback Test Mode** is set to **Off**.

➤ The outcome of the test can be:

- Success: The drive issues **Info 5601: Feedback Test Successful** and a pop-up dialog with the same message.
- Feedback signal was negative running whereas motor was positive: The drive issues **Fault 5604: Motor Feedback Inversed**.
- Feedback signal was 0 or very low: The drive issues **Fault 5605: No Motor Feedback**.
- Feedback signal was faster than expected: The drive issues **Fault 5603: Feedback Resolution/Poles Low**.
- Feedback signal was slower than expected: The drive issues **Fault 5602: Feedback Resolution/Poles High**.
- Feedback signal was inconsistent: Drive issues **Fault 5606: Feedback Unstable**.

6.5.4.3 Overview of U/f Settings

The parameters are used to set the U/f motor control curve manually. Make sure that the parameter **Motor Control Principle** is set to **U/f**.

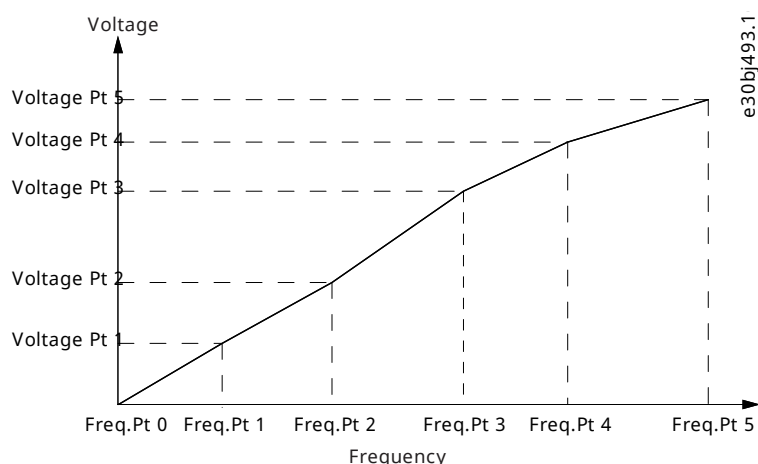

Figure 55: U/f Settings

6.5.4.4 U/f Settings (Menu Index 4.3.2)

P 4.3.2.1 Voltage Point 0

Description: Set the U/f curve voltage point 0.

Default Value: 8	Parameter Type: Range (0 — *)	Parameter Number: 2600
Unit: V	Data Type: REAL	Access Type: Read/Write

P 4.3.2.2 Voltage Point 1

Description: Set the U/f curve voltage point 1.

Default Value: 80	Parameter Type: Range (0 — *)	Parameter Number: 2601
Unit: V	Data Type: REAL	Access Type: Read/Write

P 4.3.2.3 Voltage Point 2

Description: Set the U/f curve voltage point 2.

Default Value: 160	Parameter Type: Range (0 — *)	Parameter Number: 2602
Unit: V	Data Type: REAL	Access Type: Read/Write

P 4.3.2.4 Voltage Point 3

Description: Set the U/f curve voltage point 3.

Default Value: 240	Parameter Type: Range (0 — *)	Parameter Number: 2603
Unit: V	Data Type: REAL	Access Type: Read/Write

P 4.3.2.5 Voltage Point 4

Description: Set the U/f curve voltage point 4.

Default Value: 320	Parameter Type: Range (0 — *)	Parameter Number: 2604
Unit: V	Data Type: REAL	Access Type: Read/Write

P 4.3.2.6 Voltage Point 5

Description: Set the U/f curve voltage point 5.

Default Value: 400	Parameter Type: Range (0 — *)	Parameter Number: 2605
Unit: V	Data Type: REAL	Access Type: Read/Write

P 4.3.2.7 Frequency Point 0

Description: Set the U/f curve frequency point 0.

Default Value: 0	Parameter Type: Range (0 — 2000)	Parameter Number: 2610
Unit: Hz	Data Type: REAL	Access Type: Read/Write

P 4.3.2.8 Frequency Point 1

Description: Set the U/f curve frequency point 1.

Default Value: 10	Parameter Type: Range (0 — 2000)	Parameter Number: 2611
Unit: Hz	Data Type: REAL	Access Type: Read/Write

P 4.3.2.9 Frequency Point 2

Description: Set the U/f curve frequency point 2.

Default Value: 20	Parameter Type: Range (0 — 2000)	Parameter Number: 2612
Unit: Hz	Data Type: REAL	Access Type: Read/Write

P 4.3.2.10 Frequency Point 3

Description: Set the U/f curve frequency point 3.

Default Value: 30	Parameter Type: Range (0 — 2000)	Parameter Number: 2613
Unit: Hz	Data Type: REAL	Access Type: Read/Write

P 4.3.2.11 Frequency Point 4

Description: Set the U/f curve frequency point 4.

Default Value: 40	Parameter Type: Range (0 — 2000)	Parameter Number: 2614
Unit: Hz	Data Type: REAL	Access Type: Read/Write

P 4.3.2.12 Frequency Point 5

Description: Set the U/f curve frequency point 5.

Default Value: 50	Parameter Type: Range (0 — 2000)	Parameter Number: 2615
Unit: Hz	Data Type: REAL	Access Type: Read/Write

6.5.4.5 FVC+ Settings (Menu Index 4.3.3)

P 4.3.3.1 Continuous Rs Estimation

Description: Enables Rs estimation while running, to compensate for changing operating conditions.

Default Value: 1 [Enabled]	Parameter Type: Selection	Parameter Number: 428
Unit: -	Data Type: BOOL	Access Type: Read/Write

The following are the selections for the parameter.

Selection Number	Selection Name	Selection Description
0	Disabled	Disables the function.
1	Enabled	Enables the function.

P 4.3.3.2 Current Controller Kp

Description: Set the scaling of the current controller nominal proportional gain.

Default Value: 100	Parameter Type: Range (0 — 100000)	Parameter Number: 8021
Unit: %	Data Type: REAL	Access Type: Read/Write

P 4.3.3.3 Current Controller Ti

Description: Set the scaling of the current controller nominal integral time.

Default Value: 100	Parameter Type: Range (0.1 — 100000)	Parameter Number: 8022
Unit: %	Data Type: REAL	Access Type: Read/Write

P 4.3.3.5 Low-speed Mode

Description: Select the motor control mode used at low speeds.

Default Value: 0 [Selected motor control]	Parameter Type: Selection	Parameter Number: 2816
Unit: -	Data Type: UINT	Access Type: Read/Write

The following are the selections for the parameter.

Selection Number	Selection Name	Selection Description
0	Selected motor control	Uses the selected motor control at low speed.
1	Forced current mode (I/f Control)	Selects robust I/f current control at low speed.
2	HF injection	Adds HF injection to improve speed estimation performance at low speed.
3	Low speed minimum current (only in FVC SM)	Ensures a minimum current in FVC+ speed mode at low speed.
4	Saliency Tracking	Adds saliency tracking at low speed.

P 4.3.3.6 I/f Control Current Reference

Description: Set the I/f control current reference in % of nominal motor current.

Default Value: 100	Parameter Type: Range (0 — 500)	Parameter Number: 2817
Unit: %	Data Type: REAL	Access Type: Read/Write

P 4.3.3.7 I/f Control Speed Threshold

Description: Set the speed below which the I/f control is used.

Default Value: 10	Parameter Type: Range (1 — *)	Parameter Number: 2818
Unit: Hz	Data Type: REAL	Access Type: Read/Write

P 4.3.3.8 Low Speed Minimum Current

Description: Set the low-speed minimum current reference in % of nominal motor current.

Default Value: 50	Parameter Type: Range (0 — 100)	Parameter Number: 2837
Unit: %	Data Type: REAL	Access Type: Read/Write

P 4.3.3.9 Minimum Current Speed Threshold

Description: Set the speed below which the minimum current control is used.

Default Value: 10	Parameter Type: Range (1 — *)	Parameter Number: 2838
Unit: Hz	Data Type: REAL	Access Type: Read/Write

P 4.3.3.11 Relative HF Injection Voltage Gain

Description: Set the voltage gain for HF injection relative to the recommended voltage.

Default Value: 100	Parameter Type: Range (5 — 2000)	Parameter Number: 2821
Unit: %	Data Type: REAL	Access Type: Read/Write

P 4.3.3.12 Relative HF Inject Bandwidth

Description: Set the bandwidth for HF injection relative to the recommended bandwidth.

Default Value: 100	Parameter Type: Range (1 — 1000)	Parameter Number: 2826
Unit: %	Data Type: REAL	Access Type: Read/Write

P 4.3.3.13 HF Injection Angle Comp. Gain

Description: Set the HF injection angle error compensation gain in degrees per nominal load torque.

Default Value: 0	Parameter Type: Range (-35 — 35)	Parameter Number: 2822
Unit: °	Data Type: REAL	Access Type: Read/Write

P 4.3.3.14 HF Injection Angle Comp. Offset

Description: Set the HF injection angle error compensation offset in degrees.

Default Value: 0	Parameter Type: Range (-25 — 25)	Parameter Number: 2824
Unit: °	Data Type: REAL	Access Type: Read/Write

P 4.3.3.15 HF Injection Frequency

Description: Set the HF injection frequency. Setting 0 is equal to automatic setting of injection frequency.

Default Value: 0	Parameter Type: Range (0 — *)	Parameter Number: 2823
Unit: Hz	Data Type: REAL	Access Type: Read/Write

P 4.3.3.16 IdIq Reference Ratio

Description: Set the synchronous motor Id/Iq current reference ratio in %. It is used instead of the default MTPA, if it is set to be different from 0.

Default Value: 0	Parameter Type: Range (-100 — 100)	Parameter Number: 1219
Unit: %	Data Type: REAL	Access Type: Read/Write

P 4.3.3.17 Maximum Motor Voltage

Description: Set the maximum output voltage applied to the motor. This can be used to avoid a field-weakening operation when running at speeds above the nominal motor speed, when the drive is supplied with a voltage higher than the nominal motor voltage.

Default Value: 400	Parameter Type: Range (* — *)	Parameter Number: 5433
Unit: V	Data Type: REAL	Access Type: Read/Write

P 4.3.3.18 Encoder Slip Adjustment

Description: Enables the encoder slip correction function for permanent magnet motors in closed loop FVC+ control.

Default Value: 0 [Disabled]	Parameter Type: Selection	Parameter Number: 4602
Unit: -	Data Type: BOOL	Access Type: Read/Write

The following are the selections for the parameter.

Selection Number	Selection Name	Selection Description
0	Disabled	Disables the function.
1	Enabled	Enables the function.

P 4.3.3.19 Torque Estimation Bandwidth

Description: Set scaling factor for torque estimation correction bandwidth. 100% = default tuning, 0% = disable. Applies only to permanent magnet motors.

Default Value: 100	Parameter Type: Range (0 — 1000)	Parameter Number: 4612
Unit: %	Data Type: REAL	Access Type: Read/Write

6.5.4.6 VVC+ & U/f Settings (Menu Index 4.3.4)

P 4.3.4.1 Slip Compensation

Description: Set the slip compensation in % of nominal motor slip.

Default Value: 100	Parameter Type: Range (0 — 1000)	Parameter Number: 2804
Unit: %	Data Type: REAL	Access Type: Read/Write

P 4.3.4.2 Slip Compensation Tc

Description: Set the slip compensation time constant.

Default Value: 50.00	Parameter Type: Range (0.00 — 100000.00)	Parameter Number: 2805
Unit: ms	Data Type: REAL	Access Type: Read/Write

P 4.3.4.3 High-speed Load Comp.

Description: Set the high-speed load compensation in % of the motor voltage drop.

Default Value: 100	Parameter Type: Range (0 — 1000)	Parameter Number: 2803
Unit: %	Data Type: REAL	Access Type: Read/Write

P 4.3.4.4 Low-speed Load Comp.

Description: Set the low-speed load compensation in % of the motor voltage drop.

Default Value: 100	Parameter Type: Range (0 — 1000)	Parameter Number: 2802
Unit: %	Data Type: REAL	Access Type: Read/Write

P 4.3.4.5 Res. Damp. Gain

Description: Set the resonance damping gain in % of nominal slip for induction motors, and 0.1 times the nominal frequency for permanent magnet motors.

Default Value: 100	Parameter Type: Range (0 — 50000)	Parameter Number: 2806
Unit: %	Data Type: REAL	Access Type: Read/Write

P 4.3.4.6 Res. Damp. High Pass Tc

Description: Set the resonance damping high-pass time constant.

Default Value: 50.00	Parameter Type: Range (0.00 — 100000.00)	Parameter Number: 2807
Unit: ms	Data Type: REAL	Access Type: Read/Write

P 4.3.4.7 Res. Damp Low Pass Tc

Description: Set the resonance damping low-pass time constant.

Default Value: 1.00	Parameter Type: Range (0.00 — 100000.00)	Parameter Number: 2808
Unit: ms	Data Type: REAL	Access Type: Read/Write

P 4.3.4.9 Res. Damp. High Pass Tc (SM)

Description: Set time constant of resonance damping for VVC+ control of synchronous motors (SM).

Default Value:	Parameter Type: Range (0 — 1)	Parameter Number: 2819
Unit: s	Data Type: REAL	Access Type: Read/Write

P 4.3.4.10 Motor Model Tc (SM)

Description: Set the time constant of the internal model used for VVC+ control of synchronous motors (SM). A lower value improves the dynamic control performance. A higher value improves the noise reduction.

Default Value:	Parameter Type: Range (0 — 1)	Parameter Number: 2820
Unit: s	Data Type: REAL	Access Type: Read/Write

P 4.3.4.11 Low Speed Minimum Current

Description: Set the low-speed minimum current reference in % of nominal motor current.

Default Value: 50	Parameter Type: Range (0 — 100)	Parameter Number: 2837
Unit: %	Data Type: REAL	Access Type: Read/Write

P 4.3.4.12 Nominal Magnetization Speed

Description: Set the minimum speed for nominal motor magnetization. Used by constant torque (CT).

Default Value: 0.5	Parameter Type: Range (0 — 1000)	Parameter Number: 2844
Unit: Hz	Data Type: REAL	Access Type: Read/Write

P 4.3.4.13 Zero Speed Magnetization

Description: Set the % of motor magnetization at 0 speed used by constant torque (CT). The selection of a low value reduces energy loss in the motor, but also reduces load capacity.

Default Value: 100	Parameter Type: Range (0 — 1000)	Parameter Number: 2845
Unit: %	Data Type: REAL	Access Type: Read/Write

P 4.3.4.14 Current Limiter Kp

Description: Set the proportional gain of the current limit controller.

Default Value: 100	Parameter Type: Range (0 — 500)	Parameter Number: 3193
Unit: %	Data Type: REAL	Access Type: Read/Write

P 4.3.4.15 Current Limiter Ti

Description: Set the integration time of the current limit controller. The value is scaled to % of the nominal setting.

Default Value: 100	Parameter Type: Range (0 — 500)	Parameter Number: 3194
Unit: %	Data Type: REAL	Access Type: Read/Write

6.5.4.7 Additional Information for VVC+ & U/f Settings

P 4.3.4.3 High-speed Load Comp. and P 4.3.4.4 Low Speed Load Comp.

The parameters **4.3.4.3 High-speed Load Comp.** and **4.3.4.4 Low Speed Load Comp.** are used to set the % value to compensate voltage in relation to load when the motor is running at high/low speed, and obtain the optimum U/f characteristics. The motor size determines the frequency range within which the parameters are active, as shown in the illustration.

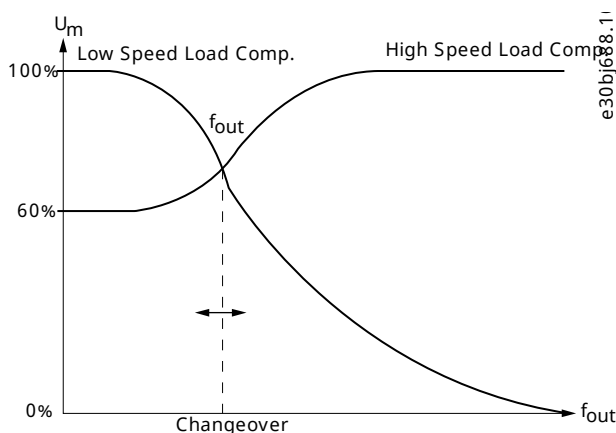

Figure 56: Changeover from Low Speed Load Compensation to High Speed Load Compensation

6.5.5 Protection (Menu Index 4.5)

P 4.5.1 Missing Phase Start-up Detection

Description: Enables detection of missing motor phase at start-up.

Default Value: 0 [Disabled]	Parameter Type: Selection	Parameter Number: 6070
Unit: -	Data Type: UINT	Access Type: Read/Write

The following are the selections for the parameter.

Selection Number	Selection Name	Selection Description
0	Disabled	Disables the function.
1	Enabled	Enables the function.

P 4.5.2 Missing Motor Phase Response

Description: Select the response to a missing motor phase.

Default Value: 1 [Fault]	Parameter Type: Selection	Parameter Number: 2348
Unit: -	Data Type: UINT	Access Type: Read/Write

The following are the selections for the parameter.

Selection Number	Selection Name	Selection Description
0	No response	The event is ignored.
2	Warning	The drive issues a warning.
1	Fault	The drive issues a fault and coasts the motor.

P 4.5.3 Disconnected Motor Response

Description: Select the response to a disconnected motor.

Default Value: 0 [No response]	Parameter Type: Selection	Parameter Number: 2349
Unit: -	Data Type: UINT	Access Type: Read/Write

The following are the selections for the parameter.

Selection Number	Selection Name	Selection Description
0	No response	The event is ignored.
2	Warning	The drive issues a warning.
1	Fault	The drive issues a fault and coasts the motor.
3	Motor Check	The drive checks if the motor is reconnected and resumes operation.

P 4.5.4 ETR Overtemperature Response

Description: Select the response to motor overtemperature indicated by the electronic thermal relay (ETR).

Default Value: 0 [No response]	Parameter Type: Selection	Parameter Number: 2825
Unit: -	Data Type: UINT	Access Type: Read/Write

The following are the selections for the parameter.

Selection Number	Selection Name	Selection Description
0	No response	The event is ignored.
1	Info	The event is logged in the event log.
3	Warning	The drive issues a warning.
9	Fault, ramp to coast	Issues a fault, ramps down, and coast.
10	Fault	The drive issues a fault and coasts the motor.

P 4.5.5 Motor Thermistor Input

Description: Select an input for the motor thermistor feedback.

Default Value:	Parameter Type: Selection	Parameter Number: 2839
Unit: -	Data Type: UINT	Access Type: Read/Write

P 4.5.6 Motor Thermistor Response

Description: Select the response to a motor thermistor event.

Default Value: 9 [Fault, ramp to coast]	Parameter Type: Selection	Parameter Number: 2846
Unit: -	Data Type: UINT	Access Type: Read/Write

The following are the selections for the parameter.

Selection Number	Selection Name	Selection Description
3	Warning	The drive issues a warning.
9	Fault, ramp to coast	Issues a fault, ramps down, and coast.
10	Fault	The drive issues a fault and coasts the motor.

P 4.5.7 Motor Temperature Input

Description: Select the input for the motor temperature sensor.

Default Value:	Parameter Type: Selection	Parameter Number: 2847
Unit: -	Data Type: UINT	Access Type: Read/Write

P 4.5.8 Motor Temperature Warning Level

Description: Set the temperature level for issuing a warning.

Default Value: 120	Parameter Type: Range (-300 — 300)	Parameter Number: 2848
Unit: °C	Data Type: REAL	Access Type: Read/Write

P 4.5.9 Motor Temperature Fault Level

Description: Set the temperature level for issuing a fault. The response will be ramp down and coast.

Default Value: 150	Parameter Type: Range (-300 — 300)	Parameter Number: 2919
Unit: °C	Data Type: REAL	Access Type: Read/Write

P 4.5.10 Motor Sync Loss

Description: Select the drive response if the synchronization between motor and drive is lost. This is only relevant when using a permanent magnet or synchronous reluctance motor.

Default Value: 3 [Warning]	Parameter Type: Selection	Parameter Number: 2922
Unit: -	Data Type: UINT	Access Type: Read/Write

The following are the selections for the parameter.

Selection Number	Selection Name	Selection Description
0	Disable	Synchronization loss detection is disabled.
1	Fault	The drive issues a fault if this event happens.
3	Warning	The drive will issue a warning if this event happens.

6.6 Application (Menu Index 5)

6.6.1 Application Overview

This parameter group contains parameters for application specific features such as process control, speed control, torque control, mechanical brake control, and many more.

6.6.2 Application Status (Menu Index 5.1)

P 5.1.1 Motor Ctrl. Status Word

Description: Shows the motor control status word.

Default Value: NA	Parameter Type: Range (* — *)	Parameter Number: 1714
Unit: -	Data Type: WORD	Access Type: Read Only

P 5.1.2 Motor Ctrl. Ready Status Word

Description: Shows the motor control ready status word. All status bits must be true before the drive is ready.

Default Value: NA	Parameter Type: Range (* — *)	Parameter Number: 1716
Unit: -	Data Type: WORD	Access Type: Read Only

P 5.1.3 Motor Regulator Status Word

Description: Shows the current state of the motor regulator status word. The status word indicates if a limit controller is active.

Default Value: NA	Parameter Type: Range (* — *)	Parameter Number: 1715
Unit: -	Data Type: WORD	Access Type: Read Only

P 5.1.5 Fault Status Word 1

Description: Shows the fault status word 1.

Default Value: -	Parameter Type:	Parameter Number: 6203
Unit:	Data Type: DWORD	Access Type: -

P 5.1.8 Warning Status Word 1

Description: Shows the warning status word 1.

Default Value: -	Parameter Type:	Parameter Number: 6205
Unit:	Data Type: DWORD	Access Type: -

P 5.1.13 Application Status Word

Description: Shows the application-specific status word.

Default Value: NA	Parameter Type: Range (0 — 65535)	Parameter Number: 1608
Unit: -	Data Type: WORD	Access Type: Read Only

6.6.3 Application Status Word Descriptions

P 5.1.1 Motor Ctrl. Status Word

Bit	Description
0	Ready
1	Run
2	Reverse
3	Fault
4	Reserved
5	At reference
6	Zero speed
7	Protection mode active

P 5.1.2 Motor Ctrl. Ready Status Word

Bit	Description
0	Run Enable high.
1	No fault active.
2	DC-link precharging done.

Bit	Description
3	DC Voltage within limits.
4	Power manager initialized.
5	Brake test not running.
6	System software is not blocking start.
7	Grid voltage within limits.
8	Temperature within limits.
9	Valid motor data.
10	Valid control configuration.

P 5.1.3 Motor Regulator Status Word

Bit	Description
0	Current limit control active (motoring side).
1	Current limit control active (generator side).
2	Torque limit control active (motoring side).
3	Torque limit control active (generator side).
4	Overvoltage control active.
5	Undervoltage control active.
6	Power limit control active (motoring side).
7	Power limit control active (generator side).
8	Speed limit control active.
9	AC-brake control active.

P 5.1.5 Fault Status Word 1

Bit	Description	Event number
0	Overcurrent	4384, 4373, 5170, 4368, 4369, 4375, 4377, 4380, 4097
1	Overvoltage	4164, 4162, 4144 4145
2	Undervoltage	4165, 4146
3	Unit temperature high	4117, 4118, 4119
4	Unit temperature low	4116
5	Control board overtemperature	4121, 4122, 4123, 4120
6	Input phase	4160, 4163
7	Output phase	4175, 4176

Bit	Description	Event number
8	Ground fault	4379, 4352, 4353, 4354, 4355
9	Fan failure	4128, 4129, 4133, 4130
10	Fieldbus communication	5162, 4256, 4257, 4258, 4260, 4261, 4263, 4265, 4266, 4267, 4268, 4269, 4280, 4281, 4270, 4271, 4272, 4273, 4282, 4274, 4275, 4276, 4277, 4283, 4278, 4279
11	HMI connection	5141, 5142
12	Feedback connection	4418
13	Thermistor input	5157
14	Auxiliary device (temperature)	4200, 4201, 4203, 4202
15	External temperature measurement	5132, 5133, 5134, 5135, 5136, 5137, 5158

P 5.1.8 Warning Status Word 1

Bit	Description	Event number
0	Overcurrent	4384, 4373, 5170, 4368, 4369, 4375, 4377, 4380, 4097
1	Overvoltage	4164, 4162, 4144 4145
2	Undervoltage	4165, 4146
3	Unit temperature high	4117, 4118, 4119
4	Unit temperature low	4116
5	Control board overtemperature	4121, 4122, 4123, 4120
6	Input phase	4160, 4163
7	Output phase	4175, 4176
8	Ground fault	4379, 4352, 4353, 4354, 4355
9	Fan failure	4128, 4129, 4133, 4130
10	Fieldbus communication	5162, 4256, 4257, 4258, 4260, 4261, 4263, 4265, 4266, 4267, 4268, 4269, 4280, 4281, 4270, 4271, 4272, 4273, 4282, 4274, 4275, 4276, 4277, 4283, 4278, 4279
11	HMI connection	5141, 5142
12	Feedback connection	4418
13	Thermistor input	5157
14	Auxiliary device (temperature)	4200, 4201, 4203, 4202
15	External temperature measurement	5132, 5133, 5134, 5135, 5136, 5137, 5158

P 5.1.13 Application Status Word

Bit	Bit = False	Bit = True
0	Reserved	Reserved
1	Inching not Active	Inching Active
2	Process Control not Active	Process Control Active
3	Reserved	Reserved
4	Reserved	Reserved
5	Reserved	Reserved
6	Reserved	Reserved
7	Reserved	Reserved
8	Reserved	Reserved
9	Reserved	Reserved
10	Reserved	Reserved
11	Reserved	Reserved
12	Reserved	Reserved
13	Normal Reference	Freeze Reference
14	Normal Reference	Reverse Reference
15	Speed Within Limits	Speed Limit Active

6.6.4 Protection (Menu Index 5.2)

6.6.4.1 Cooling Monitor (Menu Index 5.2.1)

P 5.2.1.1 Cooling Monitor Input

Description: Select the input for the negated cooling monitor signal.

Default Value:	Parameter Type: Selection	Parameter Number: 2400
Unit: -	Data Type: UINT	Access Type: Read/Write

P 5.2.1.2 Cooling Monitor Fault Delay

Description: Set a delay before the cooling monitor issues a fault. Only valid if fault is selected.

Default Value: 3	Parameter Type: Range (0 — 100)	Parameter Number: 2401
Unit: s	Data Type: REAL	Access Type: Read/Write

P 5.2.1.3 Cooling Monitor Response

Description: Select the response to a missing cooling monitor signal. The response is selected for both stopped and running states.

Default Value: 2 [Warning, Fault after Timeout]	Parameter Type: Selection	Parameter Number: 2402
Unit: -	Data Type: UINT	Access Type: Read/Write

The following are the selections for the parameter.

Selection Number	Selection Name	Selection Description
0	While running, Warning after Timeout	Drive issues a warning after timeout.
1	Warning	Drive issues a warning immediately.
2	Warning, Fault after Timeout	Drive issues a warning immediately. If the drive is running the warning escalates into a fault after timeout.
3	No response/Warning, Fault after Timeout	While stopped, no response is given. While running, the drive issues a warning immediately. The warning escalates into a fault after timeout.

6.6.4.2 External Event (Menu Index 5.2.2)

P 5.2.2.1 External Event 1 Input

Description: Select an input for the external event.

Default Value:	Parameter Type: Selection	Parameter Number: 4557
Unit: -	Data Type: UINT	Access Type: Read/Write

P 5.2.2.3 External Event 1 Response

Description: Select the response to an external event.

Default Value: 9 [Fault, ramp to coast]	Parameter Type: Selection	Parameter Number: 4559
Unit: -	Data Type: UINT	Access Type: Read/Write

The following are the selections for the parameter.

Selection Number	Selection Name	Selection Description
0	No response	The event is ignored.
1	Info	The event is logged in the event log.
3	Warning	The drive issues a warning.
9	Fault, ramp to coast	Issues a fault, ramps down, and coast.
10	Fault	The drive issues a fault and coasts the motor.

P 5.2.2.4 External Event 2 Input

Description: Select an input for the external event.

Default Value:	Parameter Type: Selection	Parameter Number: 4560
Unit: -	Data Type: UINT	Access Type: Read/Write

P 5.2.2.6 External Event 2 Response

Description: Select the response to an external event.

Default Value: 9 [Fault, ramp to coast]	Parameter Type: Selection	Parameter Number: 4562
Unit: -	Data Type: UINT	Access Type: Read/Write

The following are the selections for the parameter.

Selection Number	Selection Name	Selection Description
0	No response	The event is ignored.
1	Info	The event is logged in the event log.
3	Warning	The drive issues a warning.
9	Fault, ramp to coast	Issues a fault, ramps down, and coast.
10	Fault	The drive issues a fault and coasts the motor.

P 5.2.2.7 External Event Active Output

Description: Select an output indicating an external event.

Default Value:	Parameter Type: Selection	Parameter Number: 5184
Unit: -	Data Type: UINT	Access Type: Read/Write

P 5.2.2.9 External Event 1 Delay

Description: Set the time delay before an external event 1 is raised.

Default Value: 0	Parameter Type: Range (0 — 600)	Parameter Number: 4592
Unit: s	Data Type: REAL	Access Type: Read/Write

P 5.2.2.10 External Event 2 Delay

Description: Set the time delay before an external event 2 is raised.

Default Value: 0	Parameter Type: Range (0 — 600)	Parameter Number: 4593
Unit: s	Data Type: REAL	Access Type: Read/Write

6.6.4.3 Additional Information for External Event

Events can be issued via an external signal with the parameters of the External Event parameter group. The event can be delayed with parameters [5.2.2.9 External Event 1 Delay](#) and [5.2.2.10 External Event 2 Delay](#).

6.6.4.4 Measured Temp. Protection (Menu Index 5.2.3)

6.6.4.4.1 Measured Temp. Protection Status (Menu Index 5.2.3.1)

P 5.2.3.1.1 Protection 1 Temp.

Description: Shows the temperature measured for the temperature protection.

Default Value: NA	Parameter Type: Range (-300 — 300)	Parameter Number: 5200
Unit: °C	Data Type: REAL	Access Type: Read Only

P 5.2.3.1.2 Protection 2 Temp.

Description: Shows the temperature measured for the temperature protection.

Default Value: NA	Parameter Type: Range (-300 — 300)	Parameter Number: 5201
Unit: °C	Data Type: REAL	Access Type: Read Only

P 5.2.3.1.3 Protection 3 Temp.

Description: Shows the temperature measured for the temperature protection.

Default Value: NA	Parameter Type: Range (-300 — 300)	Parameter Number: 5202
Unit: °C	Data Type: REAL	Access Type: Read Only

P 5.2.3.1.4 Protection 4 Temp.

Description: Shows the temperature measured for the temperature protection.

Default Value: NA	Parameter Type: Range (-300 — 300)	Parameter Number: 5203
Unit: °C	Data Type: REAL	Access Type: Read Only

P 5.2.3.1.5 Protection 5 Temp.

Description: Shows the temperature measured for the temperature protection.

Default Value: NA	Parameter Type: Range (-300 — 300)	Parameter Number: 5204
Unit: °C	Data Type: REAL	Access Type: Read Only

P 5.2.3.1.6 Protection 6 Temp.

Description: Shows the temperature measured for the temperature protection.

Default Value: NA	Parameter Type: Range (-300 — 300)	Parameter Number: 5205
Unit: °C	Data Type: REAL	Access Type: Read Only

6.6.4.4.2 Temp. 1 Protection (Menu Index 5.2.3.2)

P 5.2.3.2.1 Temp. 1 Input

Description: Select the temperature sensor input for the temperature protection.

Default Value:	Parameter Type: Selection	Parameter Number: 5206
Unit: -	Data Type: UINT	Access Type: Read/Write

P 5.2.3.2.2 Temp. 1 Limit 1

Description: Set the temperature level for issuing a warning.

Default Value: 120	Parameter Type: Range (-300 — 300)	Parameter Number: 5207
Unit: °C	Data Type: REAL	Access Type: Read/Write

P 5.2.3.2.3 Temp. 1 Limit 2

Description: Set the temperature level for issuing a protection response.

Default Value: 150	Parameter Type: Range (-300 — 300)	Parameter Number: 5208
Unit: °C	Data Type: REAL	Access Type: Read/Write

P 5.2.3.2.4 Temp. 1 Limit 2 Response

Description: Select the response for exceeding the limit.

Default Value: 9 [Fault, ramp to coast]	Parameter Type: Selection	Parameter Number: 5209
Unit: -	Data Type: UINT	Access Type: Read/Write

The following are the selections for the parameter.

Selection Number	Selection Name	Selection Description
3	Warning	The drive issues a warning.
9	Fault, ramp to coast	Issues a fault, ramps down, and coast.
10	Fault	The drive issues a fault and coasts the motor.

6.6.4.4.3 Temp. 2 Protection (Menu Index 5.2.3.3)

P 5.2.3.3.1 Temp. 2 Input

Description: Select the temperature sensor input for the temperature protection.

Default Value:	Parameter Type: Selection	Parameter Number: 5210
Unit: -	Data Type: UINT	Access Type: Read/Write

P 5.2.3.3.2 Temp. 2 Limit 1

Description: Set the temperature level for issuing a warning.

Default Value: 120	Parameter Type: Range (-300 — 300)	Parameter Number: 5211
Unit: °C	Data Type: REAL	Access Type: Read/Write

P 5.2.3.3.3 Temp. 2 Limit 2

Description: Set the temperature level for issuing a protection response.

Default Value: 150	Parameter Type: Range (-300 — 300)	Parameter Number: 5212
Unit: °C	Data Type: REAL	Access Type: Read/Write

P 5.2.3.3.4 Temp. 2 Limit 2 Response

Description: Select the response for exceeding the limit.

Default Value: 9 [Fault, ramp to coast]	Parameter Type: Selection	Parameter Number: 5213
Unit: -	Data Type: UINT	Access Type: Read/Write

The following are the selections for the parameter.

Selection Number	Selection Name	Selection Description
3	Warning	The drive issues a warning.
9	Fault, ramp to coast	Issues a fault, ramps down, and coast.
10	Fault	The drive issues a fault and coasts the motor.

6.6.4.4.4 Temp. 3 Protection (Menu Index 5.2.3.4)

P 5.2.3.4.1 Temp. 3 Input

Description: Select the temperature sensor input for the temperature protection.

Default Value:	Parameter Type: Selection	Parameter Number: 5214
Unit: -	Data Type: UINT	Access Type: Read/Write

P 5.2.3.4.2 Temp. 3 Limit 1

Description: Set the temperature level for issuing a warning.

Default Value: 120	Parameter Type: Range (-300 — 300)	Parameter Number: 5215
Unit: °C	Data Type: REAL	Access Type: Read/Write

P 5.2.3.4.3 Temp. 3 Limit 2

Description: Set the temperature level for issuing a protection response.

Default Value: 150	Parameter Type: Range (-300 — 300)	Parameter Number: 5216
Unit: °C	Data Type: REAL	Access Type: Read/Write

P 5.2.3.4.4 Temp. 3 Limit 2 Response

Description: Select the response for exceeding the limit.

Default Value: 9 [Fault, ramp to coast]	Parameter Type: Selection	Parameter Number: 5217
Unit: -	Data Type: UINT	Access Type: Read/Write

The following are the selections for the parameter.

Selection Number	Selection Name	Selection Description
3	Warning	The drive issues a warning.
9	Fault, ramp to coast	Issues a fault, ramps down, and coast.
10	Fault	The drive issues a fault and coasts the motor.

6.6.4.4.5 **Temp. 4 Protection (Menu Index 5.2.3.5)**

P 5.2.3.5.1 Temp. 4 Input

Description: Select the temperature sensor input for the temperature protection.

Default Value:	Parameter Type: Selection	Parameter Number: 5218
Unit: -	Data Type: UINT	Access Type: Read/Write

P 5.2.3.5.2 Temp. 4 Limit 1

Description: Set the temperature level for issuing a warning.

Default Value: 120	Parameter Type: Range (-300 — 300)	Parameter Number: 5219
Unit: °C	Data Type: REAL	Access Type: Read/Write

P 5.2.3.5.3 Temp. 4 Limit 2

Description: Set the temperature level for issuing a protection response.

Default Value: 150	Parameter Type: Range (-300 — 300)	Parameter Number: 5220
Unit: °C	Data Type: REAL	Access Type: Read/Write

P 5.2.3.5.4 Temp. 4 Limit 2 Response

Description: Select the response for exceeding the limit.

Default Value: 9 [Fault, ramp to coast]	Parameter Type: Selection	Parameter Number: 5221
Unit: -	Data Type: UINT	Access Type: Read/Write

The following are the selections for the parameter.

Selection Number	Selection Name	Selection Description
3	Warning	The drive issues a warning.
9	Fault, ramp to coast	Issues a fault, ramps down, and coast.
10	Fault	The drive issues a fault and coasts the motor.

6.6.4.4.6 Temp. 5 Protection (Menu Index 5.2.3.6)

P 5.2.3.6.1 Temp. 5 Input

Description: Select the temperature sensor input for the temperature protection.

Default Value:	Parameter Type: Selection	Parameter Number: 5222
Unit: -	Data Type: UINT	Access Type: Read/Write

P 5.2.3.6.2 Temp. 5 Limit 1

Description: Set the temperature level for issuing a warning.

Default Value: 120	Parameter Type: Range (-300 — 300)	Parameter Number: 5223
Unit: °C	Data Type: REAL	Access Type: Read/Write

P 5.2.3.6.3 Temp. 5 Limit 2

Description: Set the temperature level for issuing a protection response.

Default Value: 150	Parameter Type: Range (-300 — 300)	Parameter Number: 5224
Unit: °C	Data Type: REAL	Access Type: Read/Write

P 5.2.3.6.4 Temp. 5 Limit 2 Response

Description: Select the response for exceeding the limit.

Default Value: 9 [Fault, ramp to coast]	Parameter Type: Selection	Parameter Number: 5225
Unit: -	Data Type: UINT	Access Type: Read/Write

The following are the selections for the parameter.

Selection Number	Selection Name	Selection Description
3	Warning	The drive issues a warning.
9	Fault, ramp to coast	Issues a fault, ramps down, and coast.
10	Fault	The drive issues a fault and coasts the motor.

6.6.4.4.7 Temp. 6 Protection (Menu Index 5.2.3.7)

P 5.2.3.7.1 Temp. 6 Input

Description: Select the temperature sensor input for the temperature protection.

Default Value:	Parameter Type: Selection	Parameter Number: 5226
Unit: -	Data Type: UINT	Access Type: Read/Write

P 5.2.3.7.2 Temp. 6 Limit 1

Description: Set the temperature level for issuing a warning.

Default Value: 120	Parameter Type: Range (-300 — 300)	Parameter Number: 5227
Unit: °C	Data Type: REAL	Access Type: Read/Write

P 5.2.3.7.3 Temp. 6 Limit 2

Description: Set the temperature level for issuing a protection response.

Default Value: 150	Parameter Type: Range (-300 — 300)	Parameter Number: 5228
Unit: °C	Data Type: REAL	Access Type: Read/Write

P 5.2.3.7.4 Temp. 6 Limit 2 Response

Description: Select the response for exceeding the limit.

Default Value: 9 [Fault, ramp to coast]	Parameter Type: Selection	Parameter Number: 5229
Unit: -	Data Type: UINT	Access Type: Read/Write

The following are the selections for the parameter.

Selection Number	Selection Name	Selection Description
3	Warning	The drive issues a warning.
9	Fault, ramp to coast	Issues a fault, ramps down, and coast.
10	Fault	The drive issues a fault and coasts the motor.

6.6.4.5 Blocked Rotor Detection

Use the blocked rotor detection function to detect if the rotor is blocked by the application. This feature can protect the motor or application and identify if something is preventing the drive from ramping up the motor to the desired speed reference. If the motor is running in either torque or current limit for the set detection time, the blocked rotor function triggers an event. The function only is active in the speed range from 0 up to the set blocked rotor maximum speed.

The blocked rotor detection feature is controlled with the [6.6.4.6 Blocked Rotor Detection \(Menu Index 5.2.6\)](#) parameters.

6.6.4.6 Blocked Rotor Detection (Menu Index 5.2.6)

P 5.2.6.1 Blocked Rotor Response

Description: Select how the drive responds when detecting a blocked rotor.

Default Value: 0 [No response]	Parameter Type: Selection	Parameter Number: 2370
Unit: -	Data Type: UINT	Access Type: Read/Write

The following are the selections for the parameter.

Selection Number	Selection Name	Selection Description
0	No response	The event is ignored.
3	Warning	The drive issues a warning.
1	Fault	The drive issues a fault and coasts the motor.

P 5.2.6.2 Blocked Rotor Max. Speed

Description: Set the maximum speed for checking for a blocked rotor.

Default Value: 10	Parameter Type: Range (0 — 100)	Parameter Number: 2371
Unit: Hz	Data Type: REAL	Access Type: Read/Write

P 5.2.6.3 Blocked Rotor Detection Time

Description: Set the duration that the rotor can be blocked before a response is triggered.

Default Value: 0.5	Parameter Type: Range (0.1 — 100)	Parameter Number: 2372
Unit: s	Data Type: REAL	Access Type: Read/Write

6.6.4.7 Lost Load Detection (Menu Index 5.2.7)

P 5.2.7.1 Lost-load Response

Description: Select an action for the lost-load detection. The lost-load detection is active if the motor speed is above 15 Hz.

Default Value: 0 [No response]	Parameter Type: Selection	Parameter Number: 9072
Unit: -	Data Type: UINT	Access Type: Read/Write

The following are the selections for the parameter.

Selection Number	Selection Name	Selection Description
0	No response	The event is ignored.
1	Info	The event is logged in the event log.
3	Warning	The drive issues a warning.
9	Fault, ramp to coast	Issues a fault, ramps down, and coast.
10	Fault	The drive issues a fault and coasts the motor.

P 5.2.7.2 Lost-load Detection Torque Level

Description: Set the minimum allowed torque level in % of nominal motor torque. The lost-load detection can be activated below the set level.

Default Value: 10	Parameter Type: Range (5 — 100)	Parameter Number: 9070
Unit: %	Data Type: REAL	Access Type: Read/Write

P 5.2.7.3 Lost-load Detection Delay

Description: Set the minimum duration that the torque has to be below the detection limit before activating the lost-load exception.

Default Value: 10	Parameter Type: Range (0 — 600)	Parameter Number: 9071
Unit: s	Data Type: REAL	Access Type: Read/Write

6.6.4.8 HMI Connection Loss (Menu Index 5.2.9)

P 5.2.9.1 HMI Connection Loss

Description: Select the response after lost connection to control panel or PC tool while they are in control. The timeout occurs after 5 s.

Default Value: 0 [No response]	Parameter Type: Selection	Parameter Number: 5420
Unit: -	Data Type: UINT	Access Type: Read/Write

The following are the selections for the parameter.

Selection Number	Selection Name	Selection Description
0	No response	The event is ignored.
2	Info	The event is logged in the event log.
4	Warning - Persistent	The drive issues a warning that stays active until acknowledged by a reset.
9	Fault, ramp to coast	Issues a fault, ramps down, and coast.
10	Fault	The drive issues a fault and coasts the motor.

6.6.4.9 Live Zero (Menu Index 5.2.15)

P 5.2.15.2 Live Zero Response

Description: Select the drive response to a missing input signal (live zero).

Default Value: 3 [Warning]	Parameter Type: Selection	Parameter Number: 4555
Unit: -	Data Type: UINT	Access Type: Read/Write

The following are the selections for the parameter.

Selection Number	Selection Name	Selection Description
0	No Action	The event will be ignored.
1	Info	The event is logged in the event log.
3	Warning	The drive issues a warning.
10	Fault	The drive issues a fault.

6.6.4.10 Feedback Handling (Menu Index 5.2.16)

P 5.2.16.1 Failure Handling Response

Description: Select the drive response to an encoder/resolver failure.

Default Value: 10 [Coast]	Parameter Type: Selection	Parameter Number: 4600
Unit: -	Data Type: UINT	Access Type: Read/Write

The following are the selections for the parameter.

Selection Number	Selection Name	Selection Description
3	Switch to Open Loop and Continue	The drive switches to open loop operation and continues running.
9	Switch to Open Loop and Ramp to Stop	The drive switches to open loop operation and ramps down to stop.
10	Coast	The drive coasts the motor.

6.6.5 Load (Menu Index 5.3)

6.6.5.1 Load Status (Menu Index 5.3.1)

P 5.3.1.1 Inertia Estimation Status

Description: Shows the status of the inertia estimation routine. 0 = Inactive, 1 = In progress, 2 = Completed successfully, 3 = Completed unsuccessfully.

Default Value: NA	Parameter Type: Selection	Parameter Number: 666
Unit: -	Data Type: UINT	Access Type: Read Only

The following are the selections for the parameter.

Selection Number	Selection Name	Selection Description
0	Inactive	
1	In progress	
2	Completed successfully	
3	Completed unsuccessfully	

6.6.5.2 Inertia (Menu Index 5.3.2)

P 5.3.2.1 Inertia Estimation Mode

Description: Set the mode for the inertia estimation.

Default Value: 0 [Off]	Parameter Type: Selection	Parameter Number: 668
Unit: -	Data Type: UINT	Access Type: Read/Conditional Write

The following are the selections for the parameter.

Selection Number	Selection Name	Selection Description
0	Off	The feature is disabled.
1	Without load profile	The next start command initiates a test sequence - Without speed dependent load.
2	With load profile	The next start command initiates a test sequence - With speed dependent load.

P 5.3.2.2 Inertia Estimation Timeout

Description: Set the time after which an event message will be generated if inertia estimation cannot be finalized.

Default Value: 900	Parameter Type: Range (120 — 1800)	Parameter Number: 669
Unit: s	Data Type: REAL	Access Type: Read/Write

P 5.3.2.3 System Inertia

Description: Set the system inertia.

Default Value: 0	Parameter Type: Range (0 — 10000)	Parameter Number: 667
Unit: kgm ²	Data Type: REAL	Access Type: Read/Write

6.6.5.3 Torque & AEO (Menu Index 5.3.3)

P 5.3.3.1 Torque Characteristic

Description: Select the torque characteristics matching the application needs.

Default Value: 0 [Constant torque (CT)]	Parameter Type: Selection	Parameter Number: 2809
Unit: -	Data Type: UINT	Access Type: Read/Write

The following are the selections for the parameter.

Selection Number	Selection Name	Selection Description
0	Constant torque (CT)	Typically used for applications where high load is present in the full speed range.
1	Variable torque (VT)	Typically used with quadratic loads like fans and centrifugal pumps.
2	Automatic Energy Optimization (AEO)	Motor magnetization is adapted to the current load. This functionality optimizes energy efficiency, but reduces dynamics to torque changes.

P 5.3.3.2 AEO Minimum Speed

Description: Set the speed above which Automatic Energy Optimization (AEO) is active.

Default Value: 10	Parameter Type: Range (0 — 2000)	Parameter Number: 2810
Unit: Hz	Data Type: REAL	Access Type: Read/Write

P 5.3.3.3 AEO Minimum Magnetization

Description: Set the minimum magnetization current used by Automatic Energy Optimization (AEO).

Default Value: 40	Parameter Type: Range (0 — 100)	Parameter Number: 2811
Unit: %	Data Type: REAL	Access Type: Read/Write

P 5.3.3.4 Variable Torque Zero Speed Magnetization

Description: Set the magnetization current level at 0 speed. Used in variable torque (VT) setting.

Default Value: 66	Parameter Type: Range (40 — 90)	Parameter Number: 8020
Unit: %	Data Type: REAL	Access Type: Read/Write

6.6.6 Operation Mode (Menu Index 5.4)

6.6.6.1 Settings (Menu Index 5.4.2)

P 5.4.2.16 Operation Mode

Description: Select the drive operation mode.

Default Value: 0 [Speed control]	Parameter Type: Selection	Parameter Number: 2500
Unit: -	Data Type: UINT	Access Type: Read/Write

The following are the selections for the parameter.

Selection Number	Selection Name	Selection Description
0	Speed control	The drive controls the motor speed.
1	Torque control	The drive controls the motor torque.
21	Process control	The drive controls a process variable based on feedback to the process controller.

P 5.4.2.20 Rotational Direction Limit

Description: Sets the limit for directional rotation of the motor.

Default Value: 0 [Both Directions]	Parameter Type: Selection	Parameter Number: 2501
Unit: -	Data Type: UINT	Access Type: Read/Write

The following are the selections for the parameter.

Selection Number	Selection Name	Selection Description
0	Both Directions	Allow the motor to spin both clockwise and counterclockwise.
1	Clockwise Only	Allow the motor to only run in clockwise direction with a positive reference. The minimum reference will be set to 0.
2	Counter Clockwise Only	The motor is only allowed to run in counterclockwise direction with a negative reference. Maximum reference will be set to 0.

6.6.7 Control Places (Menu Index 5.5)

6.6.7.1 Control Places Overview

The parameters of parameter group 5.5 are used to configure the source from where the drive receives its commands, and what types of references are used. The configuration of the reference sources is part of the application controller parameterization. Commands and references are configured per operation mode of the drive (see also parameter 5.4.2.16). The Industry application software supports the following control places:

- Local control through the Control Panel
- Fieldbus control
- I/O control
- Advanced control

Advanced control allows the logical combination of 2 command sources.

The supported command logic for Advanced control is:

- Source 1
- Source 2
- AND
- OR
- NAND
- NOR
- XOR
- XNOR

The supported reference logic (except for local control) is:

- Source 1
- Source 2
- Sum
- Subtract
- Divide
- Multiply
- Maximum
- Minimum
- Toggle

The following illustration shows how control places function in the iC7 drive:

Control Places

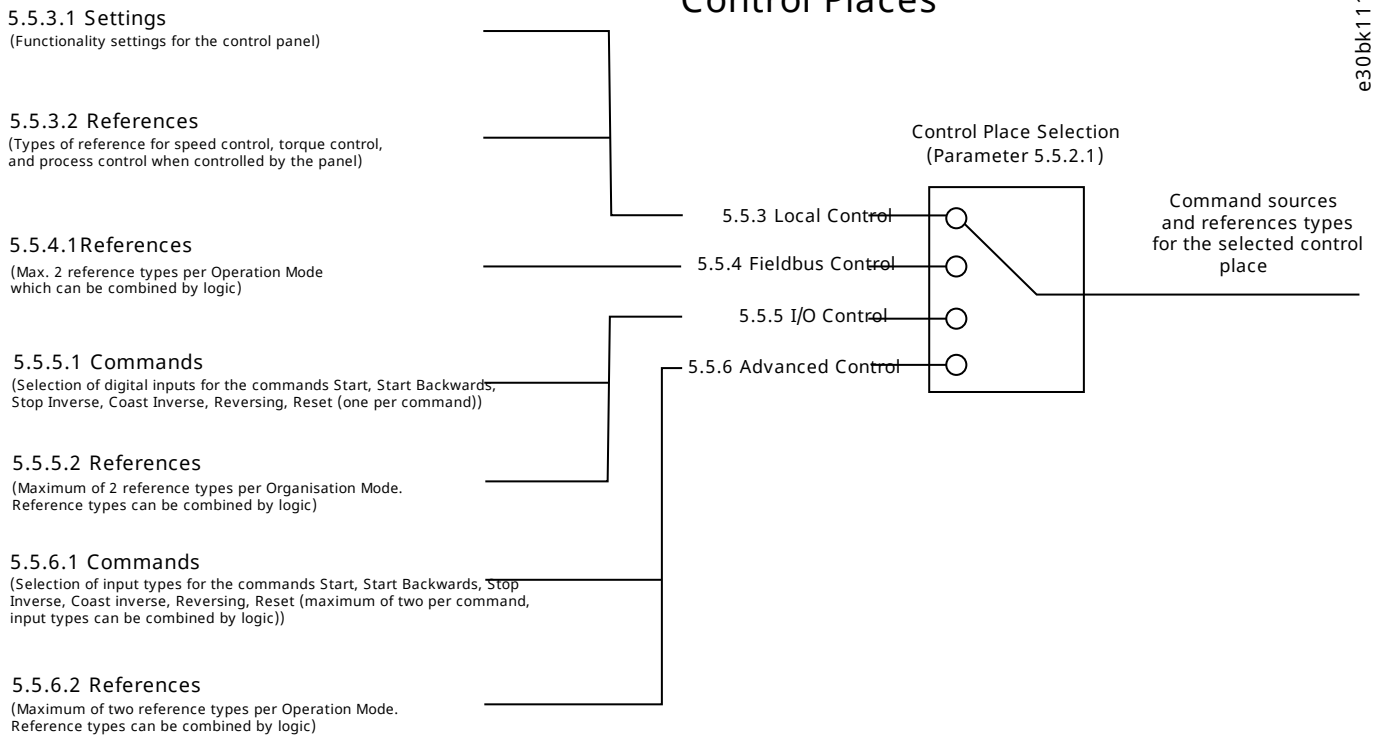

Figure 57: Control Places

6.6.7.2 Control Places Status (Menu Index 5.5.1)

P 5.5.1.1 Active Control Place

Description: Shows the control place that controls the drive.

Default Value: NA	Parameter Type: Selection	Parameter Number: 113
Unit: -	Data Type: UINT	Access Type: Read Only

The following are the selections for the parameter.

Selection Number	Selection Name	Selection Description
0	PC control	The drive is controlled by a software tool.
1	Local control	The drive is controlled by a connected control panel.
2	Fieldbus control	The drive is controlled via a fieldbus.
3	I/O control	The drive is controlled via I/O.
4	Advanced control	The drive is controlled via a combination of I/O and fieldbus.

P 5.5.1.2 Local Control Active Output

Description: Select an output terminal indicating that the drive is in local control.

Default Value:	Parameter Type: Selection	Parameter Number: 5178
Unit: -	Data Type: UINT	Access Type: Read/Write

P 5.5.1.3 Fieldbus Control Active Output

Description: Select an output terminal indicating that the drive is in fieldbus control.

Default Value:	Parameter Type: Selection	Parameter Number: 5197
Unit: -	Data Type: UINT	Access Type: Read/Write

P 5.5.1.4 I/O Control Active Output

Description: Select an output terminal indicating that the drive is in I/O control.

Default Value:	Parameter Type: Selection	Parameter Number: 5177
Unit: -	Data Type: UINT	Access Type: Read/Write

P 5.5.1.5 Advanced Control Active Output

Description: Select an output terminal indicating that the drive is in advanced control.

Default Value:	Parameter Type: Selection	Parameter Number: 4727
Unit: -	Data Type: UINT	Access Type: Read/Write

6.6.7.3 Control Place Settings (Menu Index 5.5.2)

P 5.5.2.1 Control Place Selection

Description: Select the active control place.

Default Value: 4 [Advanced control]	Parameter Type: Selection	Parameter Number: 114
Unit: -	Data Type: UINT	Access Type: Read/Write

The following are the selections for the parameter.

Selection Number	Selection Name	Selection Description
1	Local control	The drive is controlled by a connected control panel.
2	Fieldbus control	The drive is controlled via a fieldbus.
3	I/O control	The drive is controlled via I/O.
4	Advanced control	The drive is controlled via a combination of I/O and fieldbus.

P 5.5.2.7 Control Place Independent Reset

Description: Enable faults to be reset from all control places.

Default Value: 1 [Enabled]	Parameter Type: Selection	Parameter Number: 109
Unit: -	Data Type: BOOL	Access Type: Read/Write

The following are the selections for the parameter.

Selection Number	Selection Name	Selection Description
0	Disabled	Disables the function.
1	Enabled	Enables the function.

P 5.5.2.9 Alternative Control Place Selection

Description: Select the alternative control place.

Default Value: 4 [Advanced control]	Parameter Type: Selection	Parameter Number: 115
Unit: -	Data Type: UINT	Access Type: Read/Write

The following are the selections for the parameter.

Selection Number	Selection Name	Selection Description
1	Local control	The drive is controlled by a connected control panel.
2	Fieldbus control	The drive is controlled via a fieldbus.
3	I/O control	The drive is controlled via I/O.
4	Advanced control	The drive is controlled via a combination of I/O and fieldbus.

P 5.5.2.10 Alternative Control Place Input

Description: Select the digital input terminal for activating the alternative control place.

Default Value:	Parameter Type: Selection	Parameter Number: 111
Unit: -	Data Type: UINT	Access Type: Read/Write

6.6.7.4 Local Control (Menu Index 5.5.3)

6.6.7.4.1 Settings (Menu Index 5.5.3.1)

P 5.5.3.1.1 Allow Local Control Force Stop

Description: Select whether the control panel stop button always stops the drive, regardless of the selected control place. Pressing the stop button also places the drive in local control.

Default Value: 1 [Enabled]	Parameter Type: Selection	Parameter Number: 106
Unit: -	Data Type: BOOL	Access Type: Read/Write

The following are the selections for the parameter.

Selection Number	Selection Name	Selection Description
0	Disabled	Disables the function.
1	Enabled	Enables the function.

P 5.5.3.1.2 Local Control Mode

Description: Select restrictions of local control by the control panel.

Default Value: 0 [Allow Local Control]	Parameter Type: Selection	Parameter Number: 107
Unit: -	Data Type: UINT	Access Type: Read/Write

The following are the selections for the parameter.

Selection Number	Selection Name	Selection Description
0	Allow Local Control	Local mode from control panel is enabled.
1	Deny Local Start	Start in local mode from control panel is disabled.
2	Deny Local Control	Local mode from control panel is disabled.

P 5.5.3.1.3 Continue Operation in Local Control

Description: Enables running state when changing to local control.

Default Value: 1 [Enabled]	Parameter Type: Selection	Parameter Number: 108
Unit: -	Data Type: BOOL	Access Type: Read/Write

The following are the selections for the parameter.

Selection Number	Selection Name	Selection Description
0	Disabled	Disables the function.
1	Enabled	Enables the function.

P 5.5.3.1.4 Local Control Stop Button Action

Description: Select the action of the stop button in the control panel. Selecting 'Stop, Hold to Coast' will stop and coast if the stop button is pressed for 2 s.

Default Value: 2 [Stop, Hold to Coast]	Parameter Type: Selection	Parameter Number: 110
Unit: -	Data Type: UINT	Access Type: Read/Write

The following are the selections for the parameter.

Selection Number	Selection Name	Selection Description
0	Stop	Push stop button to stop the motor.
1	Coast Stop	Push stop button to coast the motor.
2	Stop, Hold to Coast	Push stop button to stop. If pressed for 2 s, motor coasts.

6.6.7.4.2 References (Menu Index 5.5.3.2)

P 5.5.3.2.1 Local Speed Ref. Source

Description: Select the speed reference source for when the drive is in local control.

Default Value: 1 [Local reference]	Parameter Type: Selection	Parameter Number: 1912
Unit: -	Data Type: UINT	Access Type: Read/Write

The following are the selections for the parameter.

Selection Number	Selection Name	Selection Description
1	Local reference	Use local reference from the control panel.
2	Fieldbus reference	Use reference from the fieldbus.
3	Reference 1 input	Use the reference from I/O reference 1.
4	Reference 2 input	Use the reference from I/O reference 2.
5	Preset reference	Use reference from the preset reference.

P 5.5.3.2.2 Local Torque Ref. Source

Description: Select the torque reference source for when the drive is in local control.

Default Value: 1 [Local reference]	Parameter Type: Selection	Parameter Number: 1925
Unit: -	Data Type: UINT	Access Type: Read/Write

The following are the selections for the parameter.

Selection Number	Selection Name	Selection Description
1	Local reference	Use local reference from the control panel.
2	Fieldbus reference	Use reference from the fieldbus.

Selection Number	Selection Name	Selection Description
3	Reference 1 input	Use the reference from I/O reference 1.
4	Reference 2 input	Use the reference from I/O reference 2.
5	Preset reference	Use reference from the preset reference.

P 5.5.3.2.3 Local Process Ref. Source

Description: Select the process control reference source for when the drive is in local control.

Default Value: 1 [Local reference]	Parameter Type: Selection	Parameter Number: 6051
Unit: -	Data Type: UINT	Access Type: Read/Write

The following are the selections for the parameter.

Selection Number	Selection Name	Selection Description
1	Local reference	Use local reference from the control panel.
2	Fieldbus reference	Use reference from the fieldbus.
3	Reference 1 input	Use the reference from I/O reference 1.
4	Reference 2 input	Use the reference from I/O reference 2.
5	Preset reference	Use reference from the preset reference.

6.6.7.5 Fieldbus control (Menu Index 5.5.4)

6.6.7.5.1 References (Menu Index 5.5.4.1)

P 5.5.4.1.1 Fieldbus Speed Reference

Description: Select the speed reference sources for when the drive operates in fieldbus control. Select 2 sources to combine them into 1 reference value.

Default Value: [2,0]	Parameter Type: Selection	Parameter Number: 1914
Unit: -	Data Type: UINT	Access Type: Read/Write

The following are the selections for the parameter.

Selection Number	Selection Name	Selection Description
0	None	No source selected equals a 0 value.
2	Fieldbus reference	Use reference from the fieldbus.
3	Reference 1 input	Use the reference from I/O reference 1.
4	Reference 2 input	Use the reference from I/O reference 2.
5	Preset reference	Use reference from the preset reference.

P 5.5.4.1.2 Fieldbus Speed Reference Logic

Description: Select how to form the speed reference out of the 2 inputs when operating in fieldbus control.

Default Value: 0 [Source 1]	Parameter Type: Selection	Parameter Number: 1911
Unit: -	Data Type: UINT	Access Type: Read/Write

The following are the selections for the parameter.

Selection Number	Selection Name	Selection Description
0	Source 1	Use value from source 1 only.
1	Source 2	Use value from source 2 only.
2	Sum	Add references from source 1 and 2 together.
3	Subtract	Subtract source 2 from source 1.
4	Divide	Divide source 1 with source 2.
5	Multiply	Multiply source 1 with source 2.
6	Maximum	Use highest value of source 1 and source 2.
7	Minimum	Use lowest value of source 1 and source 2.
8	Toggle	Toggle between source 1 and 2 using a digital input.

P 5.5.4.1.3 Fieldbus Speed Reference Toggle Input

Description: Select an input for toggling between the 2 speed reference sources selected, when operating in fieldbus control and toggling logic is used. A low signal selects the 1st source and high signal selects the 2nd source.

Default Value:	Parameter Type: Selection	Parameter Number: 1939
Unit: -	Data Type: UINT	Access Type: Read/Write

P 5.5.4.1.4 Fieldbus Torque Reference

Description: Select the torque reference sources for when the drive operates in fieldbus control. Select 2 sources to combine them into 1 reference value.

Default Value: [2,0]	Parameter Type: Selection	Parameter Number: 1928
Unit: -	Data Type: UINT	Access Type: Read/Write

The following are the selections for the parameter.

Selection Number	Selection Name	Selection Description
0	None	No source selected equals a 0 value.
2	Fieldbus reference	Use reference from the fieldbus.
3	Reference 1 input	Use the reference from I/O reference 1.
4	Reference 2 input	Use the reference from I/O reference 2.
5	Preset reference	Use reference from the preset reference.

P 5.5.4.1.5 Fieldbus Torque Reference Logic

Description: Select how to form the torque reference out of the 2 sources when operating in fieldbus control.

Default Value: 0 [Source 1]	Parameter Type: Selection	Parameter Number: 1918
Unit: -	Data Type: UINT	Access Type: Read/Write

The following are the selections for the parameter.

Selection Number	Selection Name	Selection Description
0	Source 1	Use value from source 1 only.
1	Source 2	Use value from source 2 only.
2	Sum	Add references from source 1 and 2 together.
3	Subtract	Subtract source 2 from source 1.
4	Divide	Divide source 1 with source 2.
5	Multiply	Multiply source 1 with source 2.
6	Maximum	Use highest value of source 1 and source 2.
7	Minimum	Use lowest value of source 1 and source 2.

P 5.5.4.1.6 Fieldbus Process Reference

Description: Select the process control reference sources for when the drive operates in fieldbus control. Define multiple entries for combining several sources into 1 reference value.

Default Value: [2,0]	Parameter Type: Selection	Parameter Number: 6052
Unit: -	Data Type: UINT	Access Type: Read/Write

The following are the selections for the parameter.

Selection Number	Selection Name	Selection Description
0	None	No source selected equals a 0 value.
2	Fieldbus reference	Use reference from the fieldbus.
3	Reference 1 input	Use the reference from I/O reference 1.
4	Reference 2 input	Use the reference from I/O reference 2.
5	Preset reference	Use reference from the preset reference.

P 5.5.4.1.7 Fieldbus Process Reference Logic

Description: Select how to form the process control reference out of the 2 sources when operating in fieldbus control.

Default Value: 0 [Source 1]	Parameter Type: Selection	Parameter Number: 6057
Unit: -	Data Type: UINT	Access Type: Read/Write

The following are the selections for the parameter.

Selection Number	Selection Name	Selection Description
0	Source 1	Use value from source 1 only.
1	Source 2	Use value from source 2 only.
2	Sum	Add references from source 1 and 2 together.
3	Subtract	Subtract source 2 from source 1.
4	Divide	Divide source 1 with source 2.
5	Multiply	Multiply source 1 with source 2.
6	Maximum	Use highest value of source 1 and source 2.
7	Minimum	Use lowest value of source 1 and source 2.

6.6.7.6 I/O Control (Menu Index 5.5.5)

6.6.7.6.1 Commands (Menu Index 5.5.5.1)

P 5.5.5.1.1 Start Input

Description: Select the digital input for the start command.

Default Value:	Parameter Type: Selection	Parameter Number: 200
Unit: -	Data Type: UINT	Access Type: Read/Write

P 5.5.5.1.2 Start Backward Input

Description: Select the digital input for the start command in the backward direction.

Default Value:	Parameter Type: Selection	Parameter Number: 210
Unit: -	Data Type: UINT	Access Type: Read/Write

P 5.5.5.1.3 Stop Inverse Input

Description: Select the digital input for the inverted stop command.

Default Value:	Parameter Type: Selection	Parameter Number: 201
Unit: -	Data Type: UINT	Access Type: Read/Write

P 5.5.5.1.4 Coast Inverse Input

Description: Select the digital input for the inverted coast command.

Default Value:	Parameter Type: Selection	Parameter Number: 202
Unit: -	Data Type: UINT	Access Type: Read/Write

P 5.5.5.1.5 Reversing Input

Description: Select the digital input for inverting the reference signal. The reverse command does not provide a start signal.

Default Value:	Parameter Type: Selection	Parameter Number: 204
Unit: -	Data Type: UINT	Access Type: Read/Write

P 5.5.5.1.6 Reset Input

Description: Select the digital input for resetting faults.

Default Value:	Parameter Type: Selection	Parameter Number: 203
Unit: -	Data Type: UINT	Access Type: Read/Write

P 5.5.5.1.8 Start Signal Mode

Description: Select the mode of the start signal.

Default Value: 0 [State High Start]	Parameter Type: Selection	Parameter Number: 211
Unit: -	Data Type: UINT	Access Type: Read/Write

The following are the selections for the parameter.

Selection Number	Selection Name	Selection Description
0	State High Start	Start command remains as long as input is true.
1	Rising Edge Start	Start command is set when input becomes true and remains latched until stop command is given. Start remains latched over stop if input is kept true.
2	High Pulse Start	Start command is set when input becomes true and remains latched until stop command is given.

6.6.7.6.2 References (Menu Index 5.5.5.2)

P 5.5.5.2.1 I/O Speed Reference

Description: Select the speed reference sources for when the drive operates in I/O control. Select 2 sources to combine them into 1 reference value.

Default Value: [3,0]	Parameter Type: Selection	Parameter Number: 1913
Unit: -	Data Type: UINT	Access Type: Read/Write

The following are the selections for the parameter.

Selection Number	Selection Name	Selection Description
0	None	No source selected equals a 0 value.
2	Fieldbus reference	Use reference from the fieldbus.
3	Reference 1 input	Use the reference from I/O reference 1.
4	Reference 2 input	Use the reference from I/O reference 2.
5	Preset reference	Use reference from the preset reference.

P 5.5.5.2.2 I/O Speed Reference Logic

Description: Select how to form the speed reference out of the 2 sources when operating in I/O control.

Default Value: 0 [Source 1]	Parameter Type: Selection	Parameter Number: 1910
Unit: -	Data Type: UINT	Access Type: Read/Write

The following are the selections for the parameter.

Selection Number	Selection Name	Selection Description
0	Source 1	Use value from source 1 only.
1	Source 2	Use value from source 2 only.

Selection Number	Selection Name	Selection Description
2	Sum	Add references from source 1 and 2 together.
3	Subtract	Subtract source 2 from source 1.
4	Divide	Divide source 1 with source 2.
5	Multiply	Multiply source 1 with source 2.
6	Maximum	Use highest value of source 1 and source 2.
7	Minimum	Use lowest value of source 1 and source 2.
8	Toggle	Toggle between source 1 and 2 using a digital input.

P 5.5.5.2.3 I/O Speed Reference Toggle Input

Description: Select an input for toggling between the 2 speed reference sources selected, when operating in I/O control and toggling logic is used. A low signal selects the 1st source and high signal selects the 2nd source.

Default Value:	Parameter Type: Selection	Parameter Number: 1940
Unit: -	Data Type: UINT	Access Type: Read/Write

P 5.5.5.2.4 I/O Torque Reference

Description: Select the torque reference sources for when the drive operates in I/O control. Select 2 sources to combine them into 1 reference value.

Default Value: [3,0]	Parameter Type: Selection	Parameter Number: 1927
Unit: -	Data Type: UINT	Access Type: Read/Write

The following are the selections for the parameter.

Selection Number	Selection Name	Selection Description
0	None	No source selected equals a 0 value.
2	Fieldbus reference	Use reference from the fieldbus.
3	Reference 1 input	Use the reference from I/O reference 1.
4	Reference 2 input	Use the reference from I/O reference 2.
5	Preset reference	Use reference from the preset reference.

P 5.5.5.2.5 I/O Torque Reference Logic

Description: Select how to form the torque reference out of the 2 sources when operating in I/O control.

Default Value: 0 [Source 1]	Parameter Type: Selection	Parameter Number: 1917
Unit: -	Data Type: UINT	Access Type: Read/Write

The following are the selections for the parameter.

Selection Number	Selection Name	Selection Description
0	Source 1	Use value from source 1 only.
1	Source 2	Use value from source 2 only.
2	Sum	Add references from source 1 and 2 together.
3	Subtract	Subtract source 2 from source 1.
4	Divide	Divide source 1 with source 2.
5	Multiply	Multiply source 1 with source 2.
6	Maximum	Use highest value of source 1 and source 2.
7	Minimum	Use lowest value of source 1 and source 2.

P 5.5.5.2.6 I/O Process Reference

Description: Select the process control reference sources for when the drive operates in I/O control. Select 2 sources to combine them into 1 reference value.

Default Value: [3,0]	Parameter Type: Selection	Parameter Number: 6055
Unit: -	Data Type: UINT	Access Type: Read/Write

The following are the selections for the parameter.

Selection Number	Selection Name	Selection Description
0	None	No source selected equals a 0 value.
2	Fieldbus reference	Use reference from the fieldbus.
3	Reference 1 input	Use the reference from I/O reference 1.
4	Reference 2 input	Use the reference from I/O reference 2.
5	Preset reference	Use reference from the preset reference.

P 5.5.5.2.7 I/O Process Reference Logic

Description: Select how to form the process control reference out of the 2 sources when operating in I/O control.

Default Value: 0 [Source 1]	Parameter Type: Selection	Parameter Number: 6059
Unit: -	Data Type: UINT	Access Type: Read/Write

The following are the selections for the parameter.

Selection Number	Selection Name	Selection Description
0	Source 1	Use value from source 1 only.
1	Source 2	Use value from source 2 only.
2	Sum	Add references from source 1 and 2 together.
3	Subtract	Subtract source 2 from source 1.
4	Divide	Divide source 1 with source 2.
5	Multiply	Multiply source 1 with source 2.
6	Maximum	Use highest value of source 1 and source 2.
7	Minimum	Use lowest value of source 1 and source 2.

6.6.7.7 Advanced control (Menu Index 5.5.6)

6.6.7.7.1 Commands (Menu Index 5.5.6.1)

P 5.5.6.1.1 Advanced Start Input

Description: Select inputs for starting in the forward direction when operating in advanced control.

Default Value:	Parameter Type: Selection	Parameter Number: 4722
Unit: -	Data Type: UINT	Access Type: Read/Write

P 5.5.6.1.2 Advanced Start Logic

Description: Select the combination logic for the start command of advanced control.

Default Value: 3 [OR]	Parameter Type: Selection	Parameter Number: 1933
Unit: -	Data Type: UINT	Access Type: Read/Write

The following are the selections for the parameter.

Selection Number	Selection Name	Selection Description
0	Source 1	Use value from source 1 only.
1	Source 2	Use value from source 2 only.
2	AND	Logically AND source 1 and 2.
3	OR	Logically OR source 1 and 2.
4	NAND	Logically NAND source 1 and 2.
5	NOR	Logically NOR source 1 and 2.

Selection Number	Selection Name	Selection Description
6	XOR	Logically XOR source 1 and 2.
7	XNOR	Logically XNOR source 1 and 2.

P 5.5.6.1.3 Advanced Start Backward Input

Description: Select inputs for starting in the backward direction when operating in advanced control.

Default Value:	Parameter Type: Selection	Parameter Number: 4725
Unit: -	Data Type: UINT	Access Type: Read/Write

P 5.5.6.1.4 Advanced Start Backward Logic

Description: Select the combination logic for the start-backward command of advanced control.

Default Value: 0 [Source 1]	Parameter Type: Selection	Parameter Number: 1934
Unit: -	Data Type: UINT	Access Type: Read/Write

The following are the selections for the parameter.

Selection Number	Selection Name	Selection Description
0	Source 1	Use value from source 1 only.
1	Source 2	Use value from source 2 only.
2	AND	Logically AND source 1 and 2.
3	OR	Logically OR source 1 and 2.
4	NAND	Logically NAND source 1 and 2.
5	NOR	Logically NOR source 1 and 2.
6	XOR	Logically XOR source 1 and 2.
7	XNOR	Logically XNOR source 1 and 2.

P 5.5.6.1.5 Advanced Stop Inverse Input

Description: Select inputs for stopping when operating in advanced control. False means the drive is stopped.

Default Value:	Parameter Type: Selection	Parameter Number: 4723
Unit: -	Data Type: UINT	Access Type: Read/Write

P 5.5.6.1.6 Advanced Stop Inverse Logic

Description: Select the combination logic for the stop command of advanced control.

Default Value: 0 [Source 1]	Parameter Type: Selection	Parameter Number: 1935
Unit: -	Data Type: UINT	Access Type: Read/Write

The following are the selections for the parameter.

Selection Number	Selection Name	Selection Description
0	Source 1	Use value from source 1 only.
1	Source 2	Use value from source 2 only.
2	AND	Logically AND source 1 and 2.
3	OR	Logically OR source 1 and 2.
4	NAND	Logically NAND source 1 and 2.
5	NOR	Logically NOR source 1 and 2.
6	XOR	Logically XOR source 1 and 2.
7	XNOR	Logically XNOR source 1 and 2.

P 5.5.6.1.7 Advanced Coast Inverse Input

Description: Select inputs for the coast when operating in advanced control. False means the drive is coasted.

Default Value:	Parameter Type: Selection	Parameter Number: 4724
Unit: -	Data Type: UINT	Access Type: Read/Write

P 5.5.6.1.8 Advanced Coast Inverse Logic

Description: Select the combination logic for the inverted coast command of advanced control.

Default Value: 0 [Source 1]	Parameter Type: Selection	Parameter Number: 1936
Unit: -	Data Type: UINT	Access Type: Read/Write

The following are the selections for the parameter.

Selection Number	Selection Name	Selection Description
0	Source 1	Use value from source 1 only.
1	Source 2	Use value from source 2 only.
2	AND	Logically AND source 1 and 2.
3	OR	Logically OR source 1 and 2.
4	NAND	Logically NAND source 1 and 2.
5	NOR	Logically NOR source 1 and 2.

Selection Number	Selection Name	Selection Description
6	XOR	Logically XOR source 1 and 2.
7	XNOR	Logically XNOR source 1 and 2.

P 5.5.6.1.9 Advanced Reversing Input

Description: Select inputs for inverting the reference signal when operating in advanced control. The reverse command does not provide a start signal.

Default Value:	Parameter Type: Selection	Parameter Number: 4730
Unit: -	Data Type: UINT	Access Type: Read/Write

P 5.5.6.1.10 Advanced Reverse Logic

Description: Select the combination logic for the reverse command of advanced control.

Default Value: 3 [OR]	Parameter Type: Selection	Parameter Number: 1937
Unit: -	Data Type: UINT	Access Type: Read/Write

The following are the selections for the parameter.

Selection Number	Selection Name	Selection Description
0	Source 1	Use value from source 1 only.
1	Source 2	Use value from source 2 only.
2	AND	Logically AND source 1 and 2.
3	OR	Logically OR source 1 and 2.
4	NAND	Logically NAND source 1 and 2.
5	NOR	Logically NOR source 1 and 2.
6	XOR	Logically XOR source 1 and 2.
7	XNOR	Logically XNOR source 1 and 2.

P 5.5.6.1.11 Advanced Reset Input

Description: Select inputs for resetting faults when operating in advanced control.

Default Value:	Parameter Type: Selection	Parameter Number: 4731
Unit: -	Data Type: UINT	Access Type: Read/Write

P 5.5.6.1.13 Advanced Start Mode

Description: Select the starting logic for advanced control.

Default Value: 0 [State High Start]	Parameter Type: Selection	Parameter Number: 4726
Unit: -	Data Type: UINT	Access Type: Read/Write

The following are the selections for the parameter.

Selection Number	Selection Name	Selection Description
0	State High Start	Start command remains as long as input is true.
1	Rising Edge Start	Start command is set when input becomes true and remains latched until stop command is given. Start remains latched over stop if input is kept true.
2	High Pulse Start	Start command is set when input becomes true and remains latched until stop command is given.

P 5.5.6.1.15 Fieldbus CTW Feature Bits

Description: Enables non-control-place-dependent control word bits to be active in advanced control place.

Default Value: 1 [Enabled]	Parameter Type: Selection	Parameter Number: 4627
Unit: -	Data Type: BOOL	Access Type: Read/Write

The following are the selections for the parameter.

Selection Number	Selection Name	Selection Description
0	Disabled	Disables the function.
1	Enabled	Enables the function.

6.6.7.7.2 References (Menu Index 5.5.6.2)

P 5.5.6.2.1 Adv. Speed Reference

Description: Select the speed reference sources for when the drive operates in advanced control. Select 2 sources to combine them into 1 reference value.

Default Value: [2,3]	Parameter Type: Selection	Parameter Number: 1915
Unit: -	Data Type: UINT	Access Type: Read/Write

The following are the selections for the parameter.

Selection Number	Selection Name	Selection Description
0	None	No source selected equals a 0 value.
2	Fieldbus reference	Use reference from the fieldbus.
3	Reference 1 input	Use the reference from I/O reference 1.
4	Reference 2 input	Use the reference from I/O reference 2.
5	Preset reference	Use reference from the preset reference.

P 5.5.6.2.2 Adv. Speed Reference Logic

Description: Select how to form the speed reference out of the 2 sources when operating in advanced control.

Default Value: 2 [Sum]	Parameter Type: Selection	Parameter Number: 1916
Unit: -	Data Type: UINT	Access Type: Read/Write

The following are the selections for the parameter.

Selection Number	Selection Name	Selection Description
0	Source 1	Use value from source 1 only.
1	Source 2	Use value from source 2 only.
2	Sum	Add references from source 1 and 2 together.
3	Subtract	Subtract source 2 from source 1.
4	Divide	Divide source 1 with source 2.
5	Multiply	Multiply source 1 with source 2.
6	Maximum	Use highest value of source 1 and source 2.
7	Minimum	Use lowest value of source 1 and source 2.
8	Toggle	Toggle between source 1 and 2 using a digital input.

P 5.5.6.2.3 Adv. Speed Reference Toggle Input

Description: Select an input for toggling between the 2 speed reference sources selected, when operating in advanced control and toggling logic is used. A low signal selects the 1st source and high signal selects the 2nd source.

Default Value:	Parameter Type: Selection	Parameter Number: 1941
Unit: -	Data Type: UINT	Access Type: Read/Write

P 5.5.6.2.4 Adv. Torque Reference

Description: Select the torque reference sources for when the drive operates in advanced control. Select 2 sources to combine them into 1 reference value.

Default Value: [2,0]	Parameter Type: Selection	Parameter Number: 1929
Unit: -	Data Type: UINT	Access Type: Read/Write

The following are the selections for the parameter.

Selection Number	Selection Name	Selection Description
0	None	No source selected equals a 0 value.
2	Fieldbus reference	Use reference from the fieldbus.
3	Reference 1 input	Use the reference from I/O reference 1.
4	Reference 2 input	Use the reference from I/O reference 2.
5	Preset reference	Use reference from the preset reference.

P 5.5.6.2.5 Adv. Torque Reference Logic

Description: Select how to form the torque reference out of the 2 inputs when operating in advanced control.

Default Value: 0 [Source 1]	Parameter Type: Selection	Parameter Number: 1919
Unit: -	Data Type: UINT	Access Type: Read/Write

The following are the selections for the parameter.

Selection Number	Selection Name	Selection Description
0	Source 1	Use value from source 1 only.
1	Source 2	Use value from source 2 only.
2	Sum	Add references from source 1 and 2 together.
3	Subtract	Subtract source 2 from source 1.
4	Divide	Divide source 1 with source 2.
5	Multiply	Multiply source 1 with source 2.
6	Maximum	Use highest value of source 1 and source 2.
7	Minimum	Use lowest value of source 1 and source 2.

P 5.5.6.2.6 Adv. Process Reference

Description: Select the process control reference sources for when the drive operates in advanced control. Define multiple entries for combining several sources into 1 reference value.

Default Value: [2,3]	Parameter Type: Selection	Parameter Number: 6054
Unit: -	Data Type: UINT	Access Type: Read/Write

The following are the selections for the parameter.

Selection Number	Selection Name	Selection Description
0	None	No source selected equals a 0 value.
2	Fieldbus reference	Use reference from the fieldbus.
3	Reference 1 input	Use the reference from I/O reference 1.
4	Reference 2 input	Use the reference from I/O reference 2.
5	Preset reference	Use reference from the preset reference.

P 5.5.6.2.7 Adv. Process Reference Logic

Description: Select how to form the process control reference out of the 2 inputs when operating in advanced control.

Default Value: 2 [Sum]	Parameter Type: Selection	Parameter Number: 6045
Unit: -	Data Type: UINT	Access Type: Read/Write

The following are the selections for the parameter.

Selection Number	Selection Name	Selection Description
0	Source 1	Use value from source 1 only.
1	Source 2	Use value from source 2 only.
2	Sum	Add references from source 1 and 2 together.
3	Subtract	Subtract source 2 from source 1.
4	Divide	Divide source 1 with source 2.
5	Multiply	Multiply source 1 with source 2.
6	Maximum	Use highest value of source 1 and source 2.
7	Minimum	Use lowest value of source 1 and source 2.

6.6.8 Start Settings (Menu Index 5.6)

6.6.8.1 Start Settings Overview

The application software provides the possibility to configure a DC start before entering normal motor control, for purposes of motor pre-heating, pre-magnetization, DC holding, or a start delay.

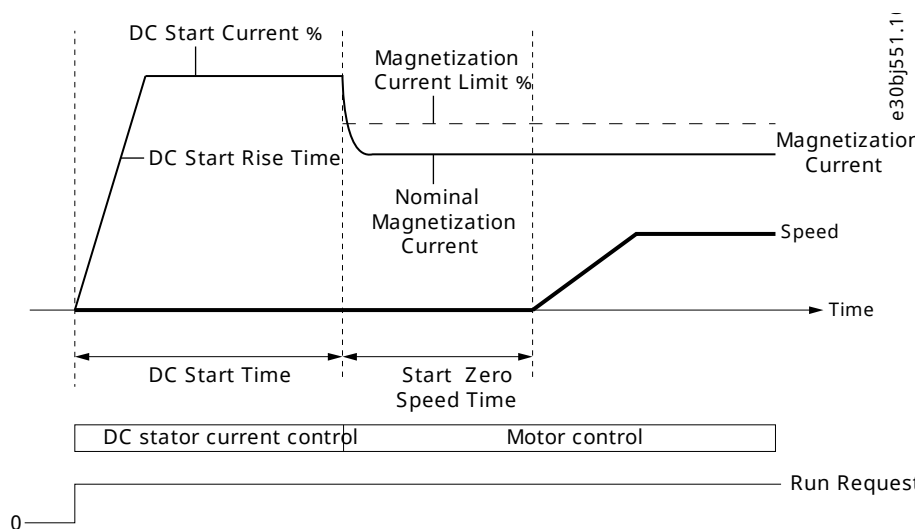

Figure 58: Induction Motor Start from Zero Speed with DC Start and Start Zero Speed Time > 0

DC start is configured using 3 parameters, 5.6.2.3 DC Start Current %, 5.6.2.1 DC Start Time, and 5.6.2.2 DC Start Rise Time.

By default, DC start is disabled by setting parameter 5.6.2.1 DC Start Time to 0. The following illustration shows an example of starting an induction at zero speed.

DC start is also used as a start delay by setting parameter 5.6.2.1 DC Start Time to the desired delay time and 5.6.2.3 DC Start Current % to 0.

DC start is only applied when starting at zero speed, or when parameter 5.6.1.2 Enable Flying Start is set to 0 [Disable] and motor back-emf voltage is not detected.

Synchronous motor control start settings

DC start is also possible from zero speed with synchronous motor control.

The following illustration shows a zero speed example with DC start and initial position handling as rotor angle detection. To set the initial position handling to rotor angle detection, set parameter 5.6.3.1 Sync. Motor Start Mode to 0 [Rotor angle detection].

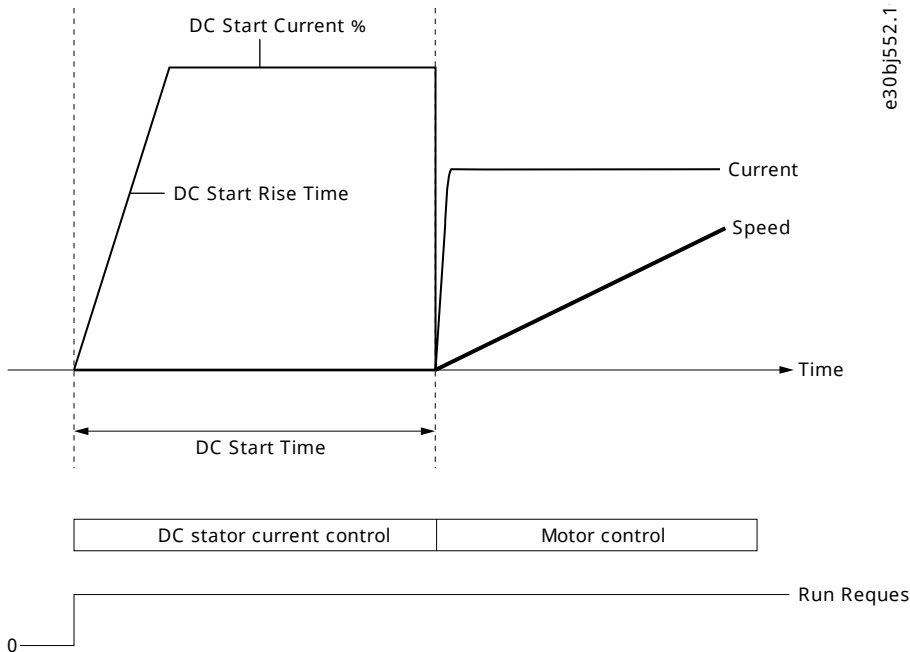

e30bj552.1

Figure 59: Synchronous Motor Start from Zero Speed with DC Start

As an alternative to rotor angle detection for a synchronous motor, it is possible to set the initial position handling as rotor angle parking by setting parameter **5.6.3.1 Sync. Motor Start Mode** to 1 [Rotor angle parking]. This option forces the motor shaft to move to a fixed position defined by the parameter **5.6.3.5 Sync. Motor Parking Angle Reference**, before ramp release.

Synchronous motor start from zero speed with DC-Start and parking is shown in the following illustration.

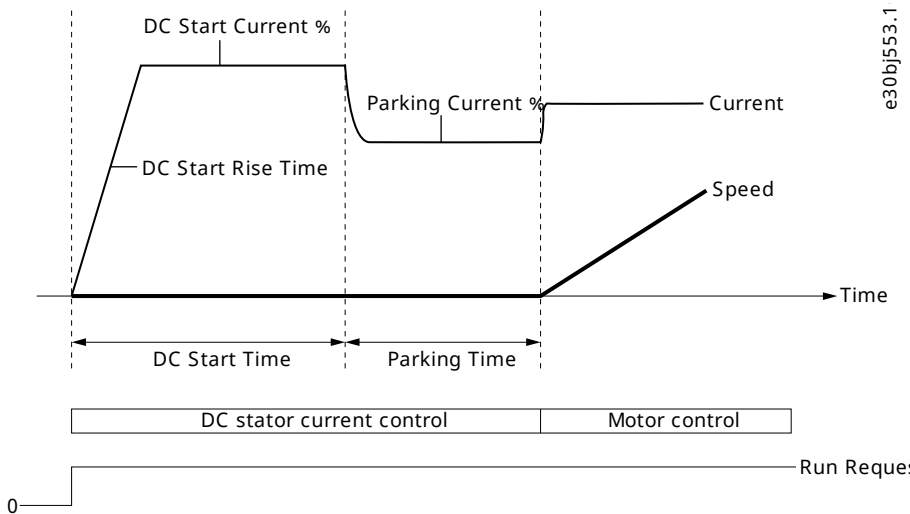

e30bj553.1

Figure 60: Synchronous Motor Start from Zero Speed with DC Start and Parking

6.6.8.2 General Settings (Menu Index 5.6.1)

P 5.6.1.1 Magnetization Time

Description: Set a delay to magnetize the motor or synchronize parallel motors before starting ramping. Set to -1 for automatic calculation.

Default Value: -1	Parameter Type: Range (-1 — 10000)	Parameter Number: 2328
Unit: s	Data Type: REAL	Access Type: Read/Write

P 5.6.1.2 Flying Start

Description: Enables a flying start. The drive will detect its current speed at the moment the start signal is given, and start to ramp towards the given reference.

Default Value: 0 [Disabled]	Parameter Type: Selection	Parameter Number: 4025
Unit: -	Data Type: BOOL	Access Type: Read/Write

The following are the selections for the parameter.

Selection Number	Selection Name	Selection Description
0	Disabled	Disables the function.
1	Enabled	Enables the function.

P 5.6.1.5 Run Enable Input

Description: Select an input enabling the drive to run.

Default Value:	Parameter Type: Selection	Parameter Number: 103
Unit: -	Data Type: UINT	Access Type: Read/Write

P 5.6.1.8 Enable Start Forward Input

Description: Select the digital input for the Start Enable command with a positive reference. If this parameter is not active, drive will be stopped while reference is positive.

Default Value:	Parameter Type: Selection	Parameter Number: 1601
Unit: -	Data Type: UINT	Access Type: Read/Write

P 5.6.1.9 Enable Start Backward Input

Description: Select the digital input for the Start Enable command with a negative reference. If this parameter is not active, the drive will be stopped while reference is negative.

Default Value:	Parameter Type: Selection	Parameter Number: 1602
Unit: -	Data Type: UINT	Access Type: Read/Write

6.6.8.3 Additional Information on General Start Settings

Enable Start Forward, Enable Start Backward

Enable Start Forward and Enable Start Backward make it possible to define end stop switches to the operation of the motor. The motor cannot keep running past the end switch.

This function is not a rotational direction prevention. It applies a stop command if start is given with reference going the wrong way. Both speed and torque directions are used.

This function works similarly to Run enable, in the sense that if either parameter is not active, the start command is suppressed in that direction.

6.6.8.4 DC Start (Menu Index 5.6.2)

P 5.6.2.1 DC Start Time

Description: Set the duration of the current injection during DC start.

Default Value: 0	Parameter Type: Range (0 — 10000)	Parameter Number: 2264
Unit: s	Data Type: REAL	Access Type: Read/Write

P 5.6.2.2 DC Start Current Rise Time

Description: Set the time to ramp the current from 0 to the specified injection level.

Default Value: 0	Parameter Type: Range (0 — 100)	Parameter Number: 2265
Unit: s	Data Type: REAL	Access Type: Read/Write

P 5.6.2.3 DC Start Current

Description: Set the DC current in % of nominal motor current. This current is injected during the DC start time.

Default Value: 0	Parameter Type: Range (0 — 1000)	Parameter Number: 2263
Unit: %	Data Type: REAL	Access Type: Read/Write

6.6.8.5 Synchronous Motor Start (Menu Index 5.6.3)

P 5.6.3.1 Sync. Motor Start Mode

Description: Set the synchronous motor initial position handling.

Default Value: 1 [Rotor angle detection]	Parameter Type: Selection	Parameter Number: 2322
Unit: -	Data Type: UINT	Access Type: Read/Write

The following are the selections for the parameter.

Selection Number	Selection Name	Selection Description
0	Disabled	Drive will not try to obtain motor angle.
1	Rotor angle detection	The drive will force the motor to be at the angle set as motor parking angle.
2	Rotor angle parking	The drive will force the motor to be at the angle set as motor parking angle.

P 5.6.3.2 Sync. Motor Detection Current

Description: Set the rotor angle detection gain in % of the nominal motor current.

Default Value: 150	Parameter Type: Range (0 — 200)	Parameter Number: 2323
Unit: %	Data Type: REAL	Access Type: Read/Write

P 5.6.3.3 Sync. Motor Parking Time

Description: Set the duration of the rotor parking.

Default Value: 3	Parameter Type: Range (0 — 10000)	Parameter Number: 2324
Unit: s	Data Type: REAL	Access Type: Read/Write

P 5.6.3.4 Sync. Motor Parking Current

Description: Set the rotor angle parking current in % of the nominal motor current.

Default Value: 100	Parameter Type: Range (0 — 1000)	Parameter Number: 2325
Unit: %	Data Type: REAL	Access Type: Read/Write

P 5.6.3.5 Sync. Motor Parking Angle

Description: Set the electrical parking angle for the rotor.

Default Value: 0	Parameter Type: Range (0 — 360)	Parameter Number: 2326
Unit: °	Data Type: REAL	Access Type: Read/Write

6.6.9 Stop Settings (Menu Index 5.7)

6.6.9.1 Stop Settings Overview

DC braking

The application software enables configuration of DC braking for induction motor control.

By default, the DC brake is disabled and parameter **5.6.2.1 DC Start Time** is set to 0.

The following settings can be configured:

- Speed at which DC braking starts by setting the required speed with parameter **5.7.2.3 DC Brake Speed**.
- Percentage of the brake current to be applied to the motor with parameter **5.7.2.2 DC Brake Current**.

- Duration for which the DC brake is active for a DC-braking current injection with parameter **5.7.2.1 DC-Brake Time**.

The following illustration shows a DC-braking scenario.

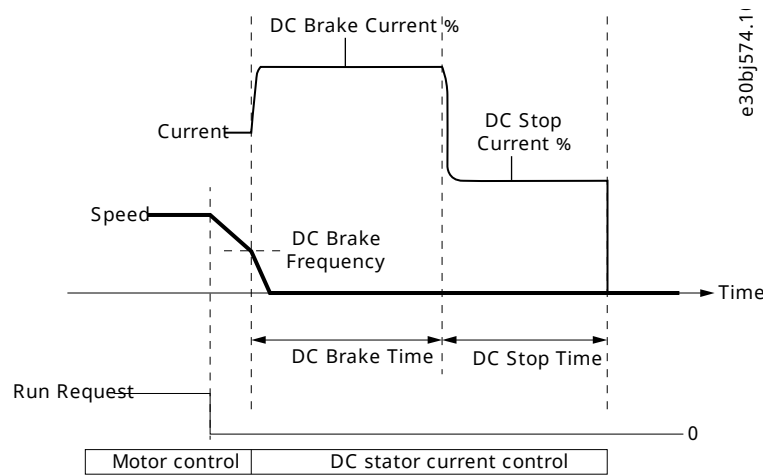

Figure 61: DC Braking and DC Stop

DC stop and stop delay

Besides the DC brake, the application software allows the configuring of DC stop, which can be used for DC hold or magnetization purposes. DC stop is configured with parameters **5.7.2.5 DC Stop Current %** and **5.7.2.4 DC Stop Time**. By default, DC stop is disabled and the parameter **5.7.2.4 DC Stop Time** is set to 0.

DC stop is always applied at zero speed and as the last activity before the drive begins to coast.

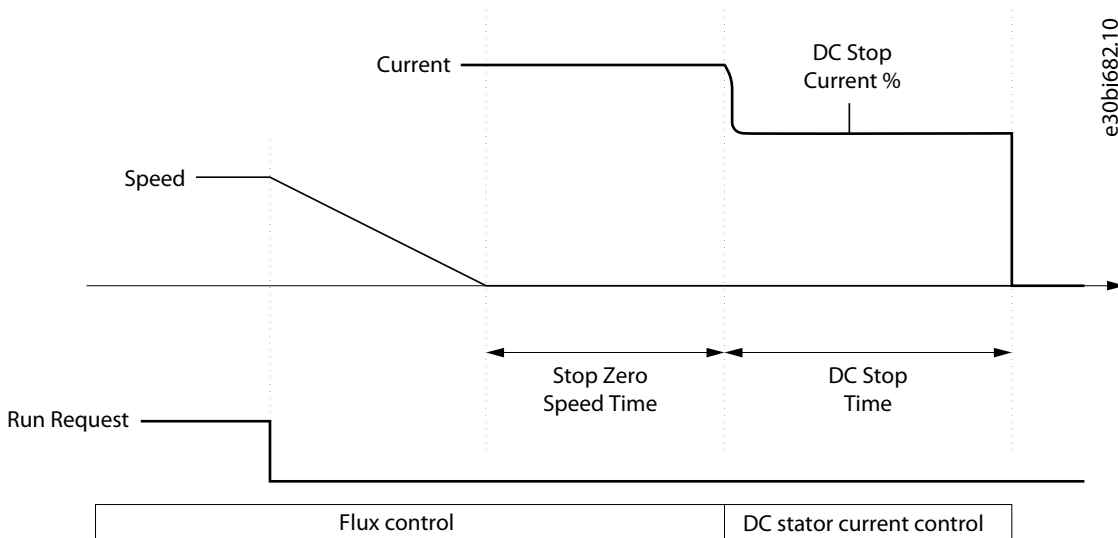

Figure 62: DC Stop and Stop Delay

When both parameters **5.7.1.1 Stop Zero Speed Time** and **5.7.2.4 DC Stop Time** are set to -1, then the parameter **5.7.1.1 Stop Zero Speed Time** has priority.

To introduce stop delay, use parameter **5.7.1.1 Stop Zero Speed Time**. By default, stop delay is disabled and parameter **5.7.1.1 Stop Zero Speed Time** is set to 0. The parameter defines the duration from reaching 0 speed to the time when the drive stops modulating or continues with DC stop. During the stop delay duration, the drive remains in run mode, modulates, and reacts to load changes.

Note: When the drive is configured for DC braking, the parameter **5.7.1.1 Stop Zero Speed Time** has no effect.

6.6.9.2 Settings (Menu Index 5.7.1)

P 5.7.1.1 Stop Zero Speed Time

Description: Set the time that motor control stays active after reaching 0 speed. The value -1 means indefinitely.

Default Value: 0	Parameter Type: Range (-1 — 10000)	Parameter Number: 2331
Unit: s	Data Type: REAL	Access Type: Read/Write

P 5.7.1.3 Torque Ramp Down Time

Description: Set the time for ramping down the remaining torque after reaching standstill.

Default Value: 0	Parameter Type: Range (0 — 10000)	Parameter Number: 2336
Unit: s	Data Type: REAL	Access Type: Read/Write

P 5.7.1.4 Zero-speed Detection Level

Description: Set the speed that is considered standstill.

Default Value: 0.20	Parameter Type: Range (0 — 2.0)	Parameter Number: 2339
Unit: Hz	Data Type: REAL	Access Type: Read/Write

P 5.7.1.5 Zero-speed Detection Delay

Description: Set the time that the speed must be below zero-speed detection level before standstill is detected.

Default Value: 0.02	Parameter Type: Range (0 — 2)	Parameter Number: 2356
Unit: s	Data Type: REAL	Access Type: Read/Write

6.6.9.3 DC Injection (Menu Index 5.7.2)

P 5.7.2.1 DC-brake Time

Description: Set the duration for a DC braking current injection.

Default Value: 0	Parameter Type: Range (0 — 10000)	Parameter Number: 2267
Unit: s	Data Type: REAL	Access Type: Read/Write

P 5.7.2.2 DC-brake Current

Description: Set the DC braking current in % of nominal motor current.

Default Value: 0	Parameter Type: Range (0 — 1000)	Parameter Number: 2266
Unit: %	Data Type: REAL	Access Type: Read/Write

P 5.7.2.3 DC-brake Speed

Description: Set the speed below which DC braking is activated.

Default Value: 0	Parameter Type: Range (0 — *)	Parameter Number: 2268
Unit: Hz	Data Type: REAL	Access Type: Read/Write

P 5.7.2.4 DC Stop Time

Description: Set the DC stopping injection duration. The value -1 means indefinitely.

Default Value: 0	Parameter Type: Range (-1 — 10000)	Parameter Number: 2320
Unit: s	Data Type: REAL	Access Type: Read/Write

P 5.7.2.5 DC Stop Current

Description: Set the DC stopping current in % of nominal motor current. Applied after the drive has reached standstill.

Default Value: 0	Parameter Type: Range (0 — 1000)	Parameter Number: 2321
Unit: %	Data Type: REAL	Access Type: Read/Write

6.6.9.4 Quick Stop (Menu Index 5.7.3)

P 5.7.3.1 Quick Stop Inverse Input

Description: Select an input terminal for activating the Quick Stop Inverse function.

Default Value:	Parameter Type: Selection	Parameter Number: 212
Unit: -	Data Type: UINT	Access Type: Read/Write

P 5.7.3.2 Quick Stop Ramp Time

Description: Set the deceleration time for the quick stop ramp.

Default Value: 1	Parameter Type: Range (0 — 10000)	Parameter Number: 1129
Unit: s	Data Type: REAL	Access Type: Read/Write

6.6.9.5 AC Brake (Menu Index 5.7.4)

P 5.7.4.1 AC Brake

Description: Enables the AC Brake.

Default Value: 0 [Disabled]	Parameter Type: Selection	Parameter Number: 4026
Unit: -	Data Type: BOOL	Access Type: Read/Write

The following are the selections for the parameter.

Selection Number	Selection Name	Selection Description
0	Disabled	Disables the function.
1	Enabled	Enables the function.

P 5.7.4.2 AC-brake Voltage Control Kp

Description: Set the scaling of the proportional gain of the AC-brake controller.

Default Value: 100	Parameter Type: Range (0 — 500)	Parameter Number: 4027
Unit: %	Data Type: REAL	Access Type: Read/Write

P 5.7.4.3 AC-brake Voltage Control Ti

Description: Set the scaling of the integral time of the AC-brake controller.

Default Value: 100	Parameter Type: Range (0 — 500)	Parameter Number: 4028
Unit: %	Data Type: REAL	Access Type: Read/Write

P 5.7.4.4 AC-brake Current

Description: Set the maximum allowed motor current in % of nominal motor current when AC brake is enabled.

Default Value: 100	Parameter Type: Range (0 — 150)	Parameter Number: 4057
Unit: %	Data Type: REAL	Access Type: Read/Write

6.6.10 Speed Control (Menu Index 5.8)

6.6.10.1 Speed Control Overview

Parameter group **5.8 Speed Control** contains the settings and the readout values related to the speed controller.

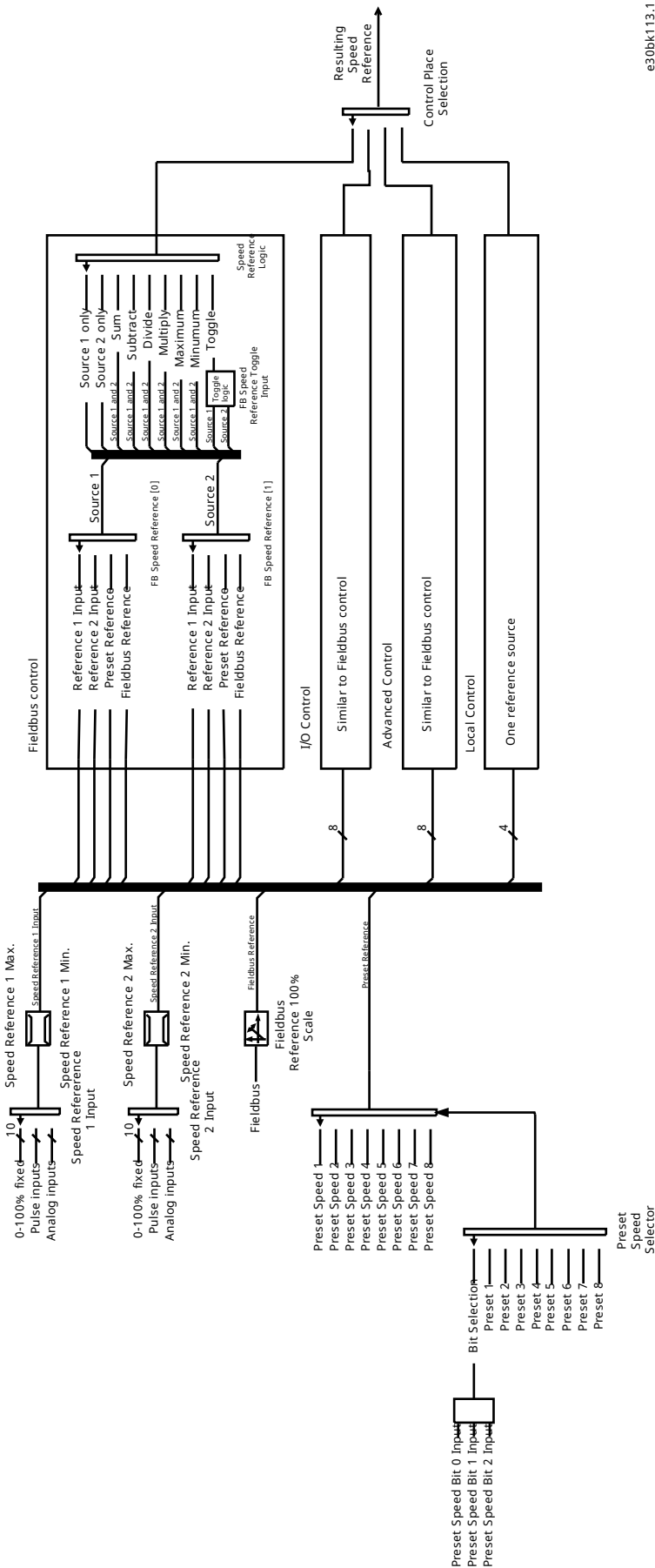

e30bk113.1

Figure 63: Reference Handling for Speed Control

6.6.10.2 Speed Control Status (Menu Index 5.8.1)

P 5.8.1.2 Motor Speed

Description: Shows the actual motor speed.

Default Value: NA	Parameter Type: Range (* — *)	Parameter Number: 9011
Unit: Hz	Data Type: REAL	Access Type: Read Only

P 5.8.1.3 Output Frequency

Description: Shows the output frequency.

Default Value: NA	Parameter Type: Range (* — *)	Parameter Number: 9015
Unit: Hz	Data Type: REAL	Access Type: Read Only

P 5.8.1.4 Feedback Speed

Description: Shows the feedback speed.

Default Value: NA	Parameter Type: Range (-10000 — 10000)	Parameter Number: 9007
Unit: rpm	Data Type: REAL	Access Type: Read Only

P 5.8.1.5 Feedback Electrical Angle

Description: Shows the feedback device angle in the electrical domain. Its value is needed for manually tuning the feedback angle offset.

Default Value: NA	Parameter Type: Range (0 — 360)	Parameter Number: 9016
Unit: °	Data Type: REAL	Access Type: Read Only

P 5.8.1.6 Speed Error

Description: Shows the difference between speed reference after ramp and motor speed.

Default Value: NA	Parameter Type: Range (* — *)	Parameter Number: 4023
Unit: Hz	Data Type: REAL	Access Type: Read Only

P 5.8.1.7 Speed Reference

Description: Shows the speed reference.

Default Value: NA	Parameter Type: Range (-2000 — 2000)	Parameter Number: 1718
Unit: Hz	Data Type: REAL	Access Type: Read/Write

P 5.8.1.8 Speed Reference Before Ramp

Description: Shows the value of speed reference before the ramp generator.

Default Value: NA	Parameter Type: Range (-2000 — 2000)	Parameter Number: 6049
Unit: Hz	Data Type: REAL	Access Type: Read Only

P 5.8.1.9 Speed Reference After Ramp

Description: Shows the value of the speed reference after the ramp generator.

Default Value: NA	Parameter Type: Range (* — *)	Parameter Number: 6150
Unit: Hz	Data Type: REAL	Access Type: Read Only

P 5.8.1.10 Final Speed Reference

Description: Shows the value of the speed reference before feeding it to the speed controller.

Default Value: NA	Parameter Type: Range (* — *)	Parameter Number: 6151
Unit: Hz	Data Type: REAL	Access Type: Read Only

P 5.8.1.11 Control Panel Speed Reference

Description: Shows the value of the speed reference given from the control panel.

Default Value: NA	Parameter Type: Range (* — *)	Parameter Number: 6153
Unit: Hz	Data Type: REAL	Access Type: Read/Write

P 5.8.1.12 Absolute Output Frequency Output

Description: Select an output terminal for the output frequency scaled between 0 Hz and positive speed limits in Hz.

Default Value:	Parameter Type: Selection	Parameter Number: 2300
Unit: -	Data Type: UINT	Access Type: Read/Write

P 5.8.1.13 Absolute Speed Reference Output

Description: Select an output terminal for the absolute speed reference, scaled between 0 and positive speed limit.

Default Value:	Parameter Type: Selection	Parameter Number: 2304
Unit: -	Data Type: UINT	Access Type: Read/Write

P 5.8.1.14 Output Frequency Output

Description: Select an output terminal for the output frequency scaled between minimum speed limit and positive speed limits in Hz.

Default Value:	Parameter Type: Selection	Parameter Number: 2308
Unit: -	Data Type: UINT	Access Type: Read/Write

P 5.8.1.16 Load Drooping Speed

Description: Shows the load drooping speed.

Default Value: NA	Parameter Type: Range (0 — 2000)	Parameter Number: 674
Unit: Hz	Data Type: REAL	Access Type: Read Only

6.6.10.3 Additional Information on Speed Control Status

P 5.8.1.12 Absolute Output Frequency Output

Note: Selection lists with inputs and/or outputs consist of the name of the hardware option and the numbers of the terminals. For example, terminal number 13 of the Basic I/O is called Basic I/O T13 in the selection list.

P 5.8.1.13 Absolute Speed Reference Output

Note: Selection lists with inputs and/or outputs consist of the name of the hardware option and the numbers of the terminals. For example, terminal number 13 of the Basic I/O is called Basic I/O T13 in the selection list.

P 5.8.1.13 Absolute Speed Reference Output

Note: Selection lists with inputs and/or outputs consist of the name of the hardware option and the numbers of the terminals. For example, terminal number 13 of the Basic I/O is called Basic I/O T13 in the selection list.

6.6.10.4 Speed Controller (Menu Index 5.8.2)

6.6.10.4.1 Basic Settings (Menu Index 5.8.2.1)

P 5.8.2.1.1 Speed Controller Type

Description: Select the speed controller type.

Default Value: 1 [PI-Controller]	Parameter Type: Selection	Parameter Number: 5005
Unit: -	Data Type: UINT	Access Type: Read/Conditional Write

The following are the selections for the parameter.

Selection Number	Selection Name	Selection Description
0	P-Controller	Select P-controller (proportional control).
1	PI-Controller	Select PI-controller (proportional and integration control).

P 5.8.2.1.2 Speed Controller Kp FVC+

Description: Set the proportional gain of the speed controller.

Default Value: 15	Parameter Type: Range (0 — 1000)	Parameter Number: 4020
Unit: PercentPerHertz	Data Type: REAL	Access Type: Read/Write

P 5.8.2.1.3 Speed Controller Ti FVC+

Description: Set the integration time of the speed controller.

Default Value: 0.1	Parameter Type: Range (0 — 100)	Parameter Number: 4021
Unit: s	Data Type: REAL	Access Type: Read/Write

P 5.8.2.1.4 Acceleration Feedforward Gain

Description: Set the acceleration feedforward gain. It bypasses the speed controller by adding torque reference based on requested acceleration and system inertia. Improves tracking of speed reference changes.

Default Value: 0	Parameter Type: Range (0 — 10000)	Parameter Number: 4022
Unit: %	Data Type: REAL	Access Type: Read/Write

P 5.8.2.1.5 Acceleration Feedforward Filter Tc

Description: Set the acceleration feedforward filter time constant.

Default Value: 0.00	Parameter Type: Range (0.00 — 1000000.00)	Parameter Number: 4039
Unit: ms	Data Type: REAL	Access Type: Read/Write

P 5.8.2.1.7 Speed Controller Kp VVC+

Description: Set the proportional gain of the speed controller.

Default Value: 0.015	Parameter Type: Range (0 — 1)	Parameter Number: 4080
Unit: -	Data Type: REAL	Access Type: Read/Write

P 5.8.2.1.8 Speed Controller Ti VVC+

Description: Set the integration time of the speed controller.

Default Value: 0.008	Parameter Type: Range (0.001 — 20)	Parameter Number: 4081
Unit: s	Data Type: REAL	Access Type: Read/Write

6.6.10.4.2 Advanced Settings (Menu Index 5.8.2.2)

P 5.8.2.2.1 Virtual Friction Gain

Description: Set the virtual friction gain, adding friction to the speed control loop to increase damping and stability. It is automatically adjusted when the system inertia is changed and parameter "5.8.11.1 Speed Controller Auto Tuning" is enabled.

Default Value: 0	Parameter Type: Range (0 — 10000)	Parameter Number: 4549
Unit: -	Data Type: REAL	Access Type: Read/Write

P 5.8.2.2.2 Low-speed Controller

Description: Enables the low-speed controller. It should be enabled if fast torque reaction at low speed references is needed.

Default Value: 0 [Disabled]	Parameter Type: Selection	Parameter Number: 4070
Unit: -	Data Type: BOOL	Access Type: Read/Write

The following are the selections for the parameter.

Selection Number	Selection Name	Selection Description
0	Disabled	Disables the function.
1	Enabled	Enables the function.

P 5.8.2.2.3 Low-speed Controller Gain

Description: Set the proportional part of the low-speed controller. A higher value leads to higher dynamics.

Default Value: 50	Parameter Type: Range (0 — 1000)	Parameter Number: 4071
Unit: %	Data Type: REAL	Access Type: Read/Write

P 5.8.2.2.4 Kp Ratio at Low Speed

Description: Set the gain ratio for the proportional part of the speed controller at frequencies below the value set in "5.8.2.2.5 Kp Adaptation Low Speed".

Default Value: 100	Parameter Type: Range (1 — 1000)	Parameter Number: 4072
Unit: %	Data Type: REAL	Access Type: Read/Write

P 5.8.2.2.5 Kp Adaptation Low Speed

Description: Set the speed below which the speed controller proportional gain is fully using the value set in "5.8.2.2.4 Kp Ratio at Low Speed".

Default Value: 0	Parameter Type: Range (0 — 10000)	Parameter Number: 4073
Unit: Hz	Data Type: REAL	Access Type: Read/Write

P 5.8.2.2.6 Kp Adaptation High Speed

Description: Set the speed above which the speed controller proportional gain is fully using the value set in "5.8.2.1.2 Speed Controller Kp FVC+".

Default Value: 0	Parameter Type: Range (0 — 10000)	Parameter Number: 4074
Unit: Hz	Data Type: REAL	Access Type: Read/Write

 P 5.8.2.2.7 Kp Ratio at Low Torque

Description: Set the gain ratio for the proportional part of the speed controller at a torque level below the lower torque limit.

Default Value: 100	Parameter Type: Range (1 — 1000)	Parameter Number: 4075
Unit: %	Data Type: REAL	Access Type: Read/Write

P 5.8.2.2.8 Kp Adaptation Low Torque

Description: Set the torque level below which the speed controller proportional gain is fully using the value set in "5.8.2.2.7 Kp Ratio at Low Torque".

Default Value: 0	Parameter Type: Range (0 — 1000)	Parameter Number: 4077
Unit: %	Data Type: REAL	Access Type: Read/Write

P 5.8.2.2.9 Kp Adaptation High Torque

Description: Set the torque level above which the speed controller proportional gain is fully using the value set in "5.8.2.1.2 Speed Controller Kp FVC+".

Default Value: 0	Parameter Type: Range (0 — 1000)	Parameter Number: 4078
Unit: %	Data Type: REAL	Access Type: Read/Write

P 5.8.2.2.10 Kp Adaptation Min at Low Flux

Description: Set the gain ratio for the proportional part, if flux is reduced by field weakening or Automatic Energy Optimization (AEO).

Default Value: 40	Parameter Type: Range (0 — 100)	Parameter Number: 4079
Unit: %	Data Type: REAL	Access Type: Read/Write

P 5.8.2.2.11 Zero-speed Damping Gain

Description: Set the zero-speed damping gain. It dampens speed fluctuations when the speed reference is 0.

Default Value: 100	Parameter Type: Range (0 — 1000)	Parameter Number: 5434
Unit: %	Data Type: REAL	Access Type: Read/Write

6.6.10.5 Speed Limits and Monitor (Menu Index 5.8.3)

P 5.8.3.1 Positive Speed Limit

Description: Set the speed limit for positive direction.

Default Value: 50	Parameter Type: Range (0 — 1000)	Parameter Number: 1729
Unit: Hz	Data Type: REAL	Access Type: Read/Write

P 5.8.3.2 Negative Speed Limit

Description: Set the speed limit for negative direction.

Default Value: -50	Parameter Type: Range (-1000 — 0)	Parameter Number: 1728
Unit: Hz	Data Type: REAL	Access Type: Read/Write

P 5.8.3.3 Minimum Speed Limit

Description: Set the minimum speed for positive and negative direction.

Default Value: 0	Parameter Type: Range (* — *)	Parameter Number: 1722
Unit: Hz	Data Type: REAL	Access Type: Read/Write

P 5.8.3.4 High Speed Warning

Description: Set the speed value which activates the high speed warning. Activated after 1 s.

Default Value: 1100	Parameter Type: Range (0 — 1100)	Parameter Number: 1200
Unit: Hz	Data Type: REAL	Access Type: Read/Write

P 5.8.3.5 High Speed Fault

Description: Set the speed value which activates the high speed fault after a delay.

Default Value: 1100	Parameter Type: Range (0 — 1100)	Parameter Number: 1201
Unit: Hz	Data Type: REAL	Access Type: Read/Write

P 5.8.3.6 High Speed Fault Delay

Description: Set the delay time after which a fault is issued if the speed set for high speed fault is exceeded.

Default Value: 10	Parameter Type: Range (0 — 360)	Parameter Number: 1202
Unit: s	Data Type: UDINT	Access Type: Read/Write

P 5.8.3.7 Start Speed Fault

Description: Set the speed which must be reached within the delay time after start. Otherwise a fault will be issued.

Default Value: 0	Parameter Type: Range (0 — 1100)	Parameter Number: 1203
Unit: Hz	Data Type: REAL	Access Type: Read/Write

P 5.8.3.8 Start Speed Fault Delay

Description: Set the time after which a fault is issued if start speed fault value is not reached.

Default Value: 20	Parameter Type: Range (0 — 360)	Parameter Number: 1204
Unit: s	Data Type: UDINT	Access Type: Read/Write

P 5.8.3.9 Low Speed Monitor Limit

Description: Set the speed value which activates the low speed fault after a delay.

Default Value: 0	Parameter Type: Range (0 — 10000)	Parameter Number: 1205
Unit: Hz	Data Type: REAL	Access Type: Read/Write

P 5.8.3.10 Low Speed Fault Delay

Description: Set the delay after which a fault is issued if speed drops below the level set for low speed monitor limit.

Default Value: 20	Parameter Type: Range (0 — 360)	Parameter Number: 1206
Unit: s	Data Type: UDINT	Access Type: Read/Write

6.6.10.6 Speed Reference (Menu Index 5.8.4)

P 5.8.4.1 Speed Reference 1 Input

Description: Select the input terminal or a predefined fixed value for the speed reference.

Default Value:	Parameter Type: Selection	Parameter Number: 501
Unit: -	Data Type: UINT	Access Type: Read/Write

P 5.8.4.2 Speed Reference 2 Input

Description: Select the input terminal or a predefined fixed value for the speed reference.

Default Value:	Parameter Type: Selection	Parameter Number: 502
Unit: -	Data Type: UINT	Access Type: Read/Write

P 5.8.4.3 Speed Reference 1 Max.

Description: Set the maximum value of the reference. It defines the upper point for the scaling of the reference input.

Default Value: 100	Parameter Type: Range (-1000 — 1000)	Parameter Number: 1724
Unit: Hz	Data Type: REAL	Access Type: Read/Write

P 5.8.4.4 Speed Reference 1 Min.

Description: Set the minimum value of the reference. It defines the lower point for the scaling of the reference input.

Default Value: 0	Parameter Type: Range (-1000 — 1000)	Parameter Number: 1725
Unit: Hz	Data Type: REAL	Access Type: Read/Write

P 5.8.4.5 Speed Reference 2 Max.

Description: Set the maximum value of the reference. It defines the upper point for the scaling of the reference input.

Default Value: 100	Parameter Type: Range (-1000 — 1000)	Parameter Number: 1726
Unit: Hz	Data Type: REAL	Access Type: Read/Write

P 5.8.4.6 Speed Reference 2 Min.

Description: Set the minimum value of the reference. It defines the lower point for the scaling of the reference input.

Default Value: 0	Parameter Type: Range (-1000 — 1000)	Parameter Number: 1727
Unit: Hz	Data Type: REAL	Access Type: Read/Write

P 5.8.4.7 Preset Speed Reference Selector

Description: Select the preset reference. The preset reference can be selected as a fixed value or by 3 digital inputs.

Default Value: 1 [Preset 1]	Parameter Type: Selection	Parameter Number: 702
Unit: -	Data Type: UINT	Access Type: Read/Write

The following are the selections for the parameter.

Selection Number	Selection Name	Selection Description
0	Bit Selection	Use digital inputs to select the preset reference number.
1	Preset 1	Use preset 1.
2	Preset 2	Use preset 2.
3	Preset 3	Use preset 3.
4	Preset 4	Use preset 4.
5	Preset 5	Use preset 5.
6	Preset 6	Use preset 6.
7	Preset 7	Use preset 7.
8	Preset 8	Use preset 8.

P 5.8.4.8 Preset Speed 1

Description: Set the value of the preset reference.

Default Value: 10	Parameter Type: Range (-1000 — 1000)	Parameter Number: 703
Unit: Hz	Data Type: REAL	Access Type: Read/Write

P 5.8.4.9 Preset Speed 2

Description: Set the value of the preset reference.

Default Value: 20	Parameter Type: Range (-1000 — 1000)	Parameter Number: 704
Unit: Hz	Data Type: REAL	Access Type: Read/Write

P 5.8.4.10 Preset Speed 3

Description: Set the value of the preset reference.

Default Value: 30	Parameter Type: Range (-1000 — 1000)	Parameter Number: 705
Unit: Hz	Data Type: REAL	Access Type: Read/Write

P 5.8.4.11 Preset Speed 4

Description: Set the value of the preset reference.

Default Value: 40	Parameter Type: Range (-1000 — 1000)	Parameter Number: 706
Unit: Hz	Data Type: REAL	Access Type: Read/Write

P 5.8.4.12 Preset Speed 5

Description: Set the value of the preset reference.

Default Value: 50	Parameter Type: Range (-1000 — 1000)	Parameter Number: 707
Unit: Hz	Data Type: REAL	Access Type: Read/Write

P 5.8.4.13 Preset Speed 6

Description: Set the value of the preset reference.

Default Value: 60	Parameter Type: Range (-1000 — 1000)	Parameter Number: 708
Unit: Hz	Data Type: REAL	Access Type: Read/Write

P 5.8.4.14 Preset Speed 7

Description: Set the value of the preset reference.

Default Value: 70	Parameter Type: Range (-1000 — 1000)	Parameter Number: 709
Unit: Hz	Data Type: REAL	Access Type: Read/Write

P 5.8.4.15 Preset Speed 8

Description: Set the value of the preset reference.

Default Value: 80	Parameter Type: Range (-1000 — 1000)	Parameter Number: 710
Unit: Hz	Data Type: REAL	Access Type: Read/Write

P 5.8.4.16 Preset Speed Reference Bit 0 Input

Description: Select the digital input used as bit 0 addressing the preset reference.

Default Value:	Parameter Type: Selection	Parameter Number: 711
Unit: -	Data Type: UINT	Access Type: Read/Write

P 5.8.4.17 Preset Speed Reference Bit 1 Input

Description: Select the digital input used as bit 1 for addressing the preset reference.

Default Value:	Parameter Type: Selection	Parameter Number: 712
Unit: -	Data Type: UINT	Access Type: Read/Write

P 5.8.4.18 Preset Speed Reference Bit 2 Input

Description: Select the digital input used as bit 2 for addressing the preset reference.

Default Value:	Parameter Type: Selection	Parameter Number: 713
Unit: -	Data Type: UINT	Access Type: Read/Write

P 5.8.4.19 Fieldbus Speed Reference Scale

Description: Set the fieldbus reference scale equal to 100% reference.

Default Value: 50	Parameter Type: Range (0 — 1000)	Parameter Number: 1723
Unit: Hz	Data Type: REAL	Access Type: Read/Write

P 5.8.4.21 Speed Ref. Filter Tc

Description: Set the time constant of the reference filter. Set to 0 disables the filter.

Default Value: 0	Parameter Type: Range (0 — 1000)	Parameter Number: 1719
Unit: s	Data Type: REAL	Access Type: Read/Write

6.6.10.7 Reference Freeze Overview

This feature makes it possible to freeze the active reference by a digital input to the actual output speed and to increase/decrease the reference by using 2 other digital inputs. Additionally, independent ramp times, delays, and speed steps can be configured.

When enabling the freeze reference feature, the reference is frozen to the actual output. If this reference is out of the allowed speed range, the frozen reference is set to the closest speed limit. After starting up or after cycling the power of the drive, the reference for the freeze feature is set to either the last freeze reference or to the minimum speed of the drive. See parameter **5.8.5.7 Freeze Initialization**.

When reaching the upper speed limit or the lower speed limit of the drive, the freeze reference is not further increased or decreased in the limited direction. If the drive is configured for both rotation directions and a minimum speed has been defined, the reference bypasses the area between the positive and the negative minimum speed while Freeze Up or Freeze Down are used.

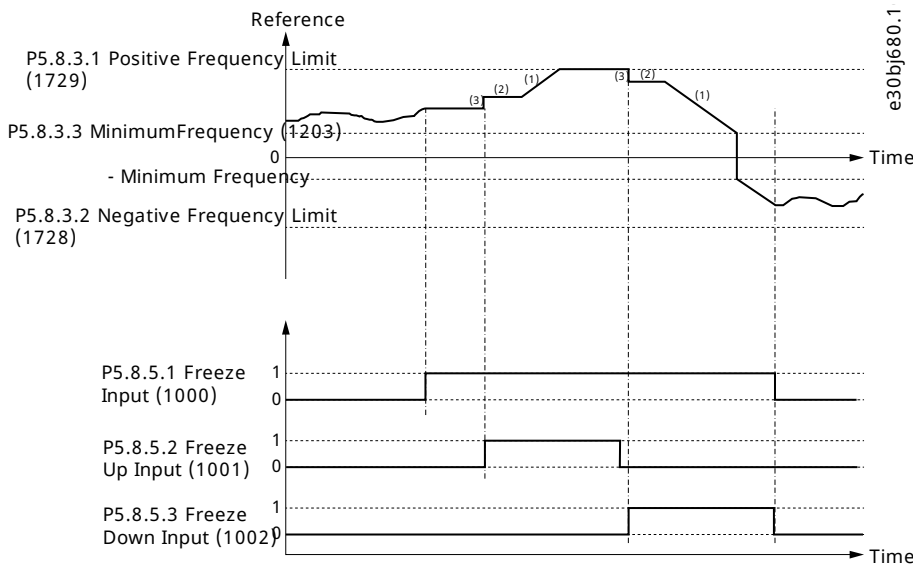

Figure 64: Reference Freeze Example

1	Freeze Up/Down Ramp Time	2	Freeze Up/Down Ramp Delay
3	Freeze Up/Down Step Delta		

6.6.10.8 Reference Freeze (Menu Index 5.8.5)

P 5.8.5.1 Freeze Input

Description: Select the digital input for freezing the reference. Freezing is used to control the speed reference with 2 digital inputs, 1 increasing the reference and the other decreasing the reference.

Default Value:	Parameter Type: Selection	Parameter Number: 1000
Unit: -	Data Type: UINT	Access Type: Read/Write

P 5.8.5.2 Freeze Up Input

Description: Select the digital input for increasing the reference while reference freezing is activated.

Default Value:	Parameter Type: Selection	Parameter Number: 1001
Unit: -	Data Type: UINT	Access Type: Read/Write

P 5.8.5.3 Freeze Down Input

Description: Select the digital input for decreasing the reference while reference freezing is activated.

Default Value:	Parameter Type: Selection	Parameter Number: 1002
Unit: -	Data Type: UINT	Access Type: Read/Write

P 5.8.5.4 Freeze Ramp Time

Description: Set the ramp time for increasing/decreasing the reference while reference freeze is active.

Default Value: 10	Parameter Type: Range (0 — 1000)	Parameter Number: 1003
Unit: s	Data Type: REAL	Access Type: Read/Write

P 5.8.5.5 Freeze Ramp Delay

Description: Set the delay before ramping the reference while reference freeze is active.

Default Value: 4	Parameter Type: Range (0 — 3600)	Parameter Number: 1004
Unit: s	Data Type: UDINT	Access Type: Read/Write

P 5.8.5.6 Freeze Step Delta

Description: Set the reference step for increasing/decreasing the reference while reference freeze is active.

Default Value: 1	Parameter Type: Range (0 — 1000)	Parameter Number: 1005
Unit: Hz	Data Type: REAL	Access Type: Read/Write

P 5.8.5.7 Freeze Initialization

Description: Enables freeze initialization. If enabled, freeze reference is initialized to the minimum speed after start-up or a start signal is applied. If disabled, the latest value is used.

Default Value: 0 [Disabled]	Parameter Type: Selection	Parameter Number: 1006
Unit: -	Data Type: BOOL	Access Type: Read/Write

The following are the selections for the parameter.

Selection Number	Selection Name	Selection Description
0	Disabled	Disables the function.
1	Enabled	Enables the function.

P 5.8.5.8 Freeze Ramp/Step Mode

Description: Select how to increase or decrease the reference while reference freeze is active.

Default Value: 0 [Step and Ramp]	Parameter Type: Selection	Parameter Number: 1007
Unit: -	Data Type: UINT	Access Type: Read/Write

The following are the selections for the parameter.

Selection Number	Selection Name	Selection Description
0	Step and Ramp	Step increment and ramp thereafter.
1	Ramp	Ramp increment.
2	Step	Step increment.

6.6.10.9 Speed Ramps (Menu Index 5.8.6)

6.6.10.9.1 Speed Ramps Overview

Ramps are used for reaching the desired speed reference in a controlled manner. The parameters in the Speed Ramps parameter group is used to select the ramp type and to adjust their shapes.

Ramps 1–4 can be configured as linear or S-ramps. A linear ramp provides the motor a constant acceleration. The S-ramp allows the drive to compensate for jerk in the application and/or to reduce sway.

The following diagram illustrates how the ramp parameters are used for adjusting the ramp profiles.

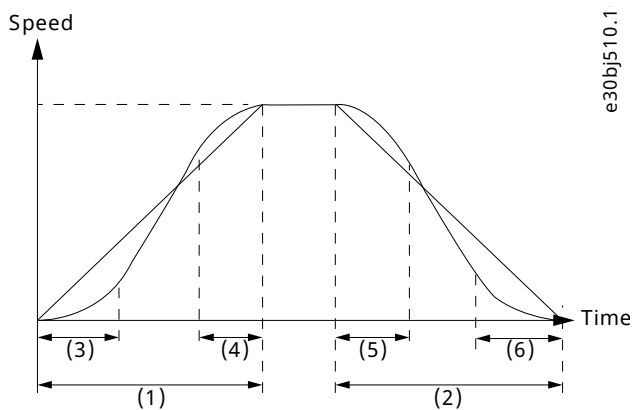

Figure 65: Speed Ramps

1	Ramp acceleration time	2	Ramp deceleration time
3	Ramp acceleration increase time for S-ramps	4	Ramp acceleration decrease time for S-ramps
5	Ramp deceleration increase time for S-ramps	6	Ramp deceleration decrease time for S-ramps

Furthermore, the drive supports a variable ramp profile, which allows the changing of the acceleration and deceleration time dynamically with analog inputs.

6.6.10.9.2 Speed Ramp Settings (Menu Index 5.8.6.1)

P 5.8.6.1.1 Ramp Selector

Description: Select the speed ramp.

Default Value: 0 [Ramp 1]	Parameter Type: Selection	Parameter Number: 1100
Unit: -	Data Type: UINT	Access Type: Read/Write

The following are the selections for the parameter.

Selection Number	Selection Name	Selection Description
4	Bit Selection	Use digital inputs to select ramp.
0	Ramp 1	Use ramp 1.
1	Ramp 2	Use ramp 2.
2	Ramp 3	Use ramp 3.
3	Ramp 4	Use ramp 4.
5	Variable Ramp.	

P 5.8.6.1.2 Ramp Selection Bit 0 Input

Description: Select the digital input used as bit 0 addressing the speed ramp.

Default Value:	Parameter Type: Selection	Parameter Number: 1130
Unit: -	Data Type: UINT	Access Type: Read/Write

P 5.8.6.1.3 Ramp Selection Bit 1 Input

Description: Select the digital input used as bit 1 addressing the speed ramp.

Default Value:	Parameter Type: Selection	Parameter Number: 1131
Unit: -	Data Type: UINT	Access Type: Read/Write

6.6.10.9.3 Ramp 1 (Menu Index 5.8.6.2)

P 5.8.6.2.1 Ramp 1 Type

Description: Select the ramp type.

Default Value: 0 [Linear Ramp]	Parameter Type: Selection	Parameter Number: 1125
Unit: -	Data Type: UINT	Access Type: Read/Write

The following are the selections for the parameter.

Selection Number	Selection Name	Selection Description
0	Linear Ramp	Use linear ramp.
1	S-Ramp	Use S-ramp ramp reducing torque changes.

P 5.8.6.2.2 Ramp 1 Accel. Time

Description: Set the acceleration time from 0 to nominal motor speed.

Default Value: 5	Parameter Type: Range (0 — 10000)	Parameter Number: 1101
Unit: s	Data Type: REAL	Access Type: Read/Write

P 5.8.6.2.3 Ramp 1 Decel. Time

Description: Set the deceleration time from nominal motor speed to 0.

Default Value: 5	Parameter Type: Range (0 — 10000)	Parameter Number: 1105
Unit: s	Data Type: REAL	Access Type: Read/Write

P 5.8.6.2.4 S-Ramp 1 Accel. Increase Time

Description: Set the ramp acceleration increase time for S-ramp.

Default Value: 1	Parameter Type: Range (0 — 10000)	Parameter Number: 1109
Unit: s	Data Type: REAL	Access Type: Read/Write

P 5.8.6.2.5 S-Ramp 1 Accel. Decrease Time

Description: Set the ramp acceleration decrease time for S-ramp.

Default Value: 1	Parameter Type: Range (0 — 10000)	Parameter Number: 1113
Unit: s	Data Type: REAL	Access Type: Read/Write

P 5.8.6.2.6 S-Ramp 1 Decel. Increase Time

Description: Set the ramp deceleration increase time for S-ramp.

Default Value: 1	Parameter Type: Range (0 — 10000)	Parameter Number: 1117
Unit: s	Data Type: REAL	Access Type: Read/Write

P 5.8.6.2.7 S-Ramp 1 Decel. Decrease Time

Description: Set the ramp deceleration decrease time for S-ramp.

Default Value: 1	Parameter Type: Range (0 — 10000)	Parameter Number: 1121
Unit: s	Data Type: REAL	Access Type: Read/Write

6.6.10.9.4 **Ramp 2 (Menu Index 5.8.6.3)**

P 5.8.6.3.1 Ramp 2 Type

Description: Select the ramp type.

Default Value: 0 [Linear Ramp]	Parameter Type: Selection	Parameter Number: 1126
Unit: -	Data Type: UINT	Access Type: Read/Write

The following are the selections for the parameter.

Selection Number	Selection Name	Selection Description
0	Linear Ramp	Use linear ramp.
1	S-Ramp	Use S-ramp ramp reducing torque changes.

P 5.8.6.3.2 Ramp 2 Accel. Time

Description: Set the acceleration time from 0 to nominal motor speed.

Default Value: 5	Parameter Type: Range (0 — 10000)	Parameter Number: 1106
Unit: s	Data Type: REAL	Access Type: Read/Write

P 5.8.6.3.3 Ramp 2 Decel. Time

Description: Set the deceleration time from nominal motor speed to 0.

Default Value: 5	Parameter Type: Range (0 — 10000)	Parameter Number: 1102
Unit: s	Data Type: REAL	Access Type: Read/Write

P 5.8.6.3.4 S-Ramp 2 Accel. Increase Time

Description: Set the ramp acceleration increase time for S-ramp.

Default Value: 1	Parameter Type: Range (0 — 10000)	Parameter Number: 1110
Unit: s	Data Type: REAL	Access Type: Read/Write

P 5.8.6.3.5 S-Ramp 2 Accel. Decrease Time

Description: Set the ramp acceleration decrease time for S-ramp.

Default Value: 1	Parameter Type: Range (0 — 10000)	Parameter Number: 1114
Unit: s	Data Type: REAL	Access Type: Read/Write

P 5.8.6.3.6 S-Ramp 2 Decel. Increase Time

Description: Set the ramp deceleration increase time for S-ramp.

Default Value: 1	Parameter Type: Range (0 — 10000)	Parameter Number: 1118
Unit: s	Data Type: REAL	Access Type: Read/Write

P 5.8.6.3.7 S-Ramp 2 Decel. Decrease Time

Description: Set the ramp deceleration decrease time for S-ramp.

Default Value: 1	Parameter Type: Range (0 — 10000)	Parameter Number: 1122
Unit: s	Data Type: REAL	Access Type: Read/Write

6.6.10.9.5 Ramp 3 (Menu Index 5.8.6.4)

P 5.8.6.4.1 Ramp 3 Type

Description: Select the ramp type.

Default Value: 0 [Linear Ramp]	Parameter Type: Selection	Parameter Number: 1127
Unit: -	Data Type: UINT	Access Type: Read/Write

The following are the selections for the parameter.

Selection Number	Selection Name	Selection Description
0	Linear Ramp	Use linear ramp.
1	S-Ramp	Use S-ramp ramp reducing torque changes.

P 5.8.6.4.2 Ramp 3 Accel. Time

Description: Set the acceleration time from 0 to nominal motor speed.

Default Value: 5	Parameter Type: Range (0 — 10000)	Parameter Number: 1103
Unit: s	Data Type: REAL	Access Type: Read/Write

P 5.8.6.4.3 Ramp 3 Decel. Time

Description: Set the deceleration time from nominal motor speed to 0.

Default Value: 5	Parameter Type: Range (0 — 10000)	Parameter Number: 1107
Unit: s	Data Type: REAL	Access Type: Read/Write

P 5.8.6.4.4 S-Ramp 3 Accel. Increase Time

Description: Set the ramp acceleration increase time for S-ramp.

Default Value: 1	Parameter Type: Range (0 — 10000)	Parameter Number: 1111
Unit: s	Data Type: REAL	Access Type: Read/Write

P 5.8.6.4.5 S-Ramp 3 Accel. Decrease Time

Description: Set the ramp acceleration decrease time for S-ramp.

Default Value: 1	Parameter Type: Range (0 — 10000)	Parameter Number: 1115
Unit: s	Data Type: REAL	Access Type: Read/Write

P 5.8.6.4.6 S-Ramp 3 Decel. Increase Time

Description: Set the ramp deceleration increase time for S-ramp.

Default Value: 1	Parameter Type: Range (0 — 10000)	Parameter Number: 1119
Unit: s	Data Type: REAL	Access Type: Read/Write

P 5.8.6.4.7 S-Ramp 3 Decel. Decrease Time

Description: Set the ramp deceleration decrease time for S-ramp.

Default Value: 1	Parameter Type: Range (0 — 10000)	Parameter Number: 1123
Unit: s	Data Type: REAL	Access Type: Read/Write

6.6.10.9.6 Ramp 4 (Menu Index 5.8.6.5)

P 5.8.6.5.1 Ramp 4 Type

Description: Select the ramp type.

Default Value: 0 [Linear Ramp]	Parameter Type: Selection	Parameter Number: 1128
Unit: -	Data Type: UINT	Access Type: Read/Write

The following are the selections for the parameter.

Selection Number	Selection Name	Selection Description
0	Linear Ramp	Use linear ramp.
1	S-Ramp	Use S-ramp ramp reducing torque changes.

P 5.8.6.5.2 Ramp 4 Accel. Time

Description: Set the acceleration time from 0 to nominal motor speed.

Default Value: 5	Parameter Type: Range (0 — 10000)	Parameter Number: 1104
Unit: s	Data Type: REAL	Access Type: Read/Write

P 5.8.6.5.3 Ramp 4 Decel. Time

Description: Set the deceleration time from nominal motor speed to 0.

Default Value: 5	Parameter Type: Range (0 — 10000)	Parameter Number: 1108
Unit: s	Data Type: REAL	Access Type: Read/Write

P 5.8.6.5.4 S-Ramp 4 Accel. Increase Time

Description: Set the ramp acceleration increase time for S-ramp.

Default Value: 1	Parameter Type: Range (0 — 10000)	Parameter Number: 1112
Unit: s	Data Type: REAL	Access Type: Read/Write

P 5.8.6.5.5 S-Ramp 4 Accel. Decrease Time

Description: Set the ramp acceleration decrease time for S-ramp.

Default Value: 1	Parameter Type: Range (0 — 10000)	Parameter Number: 1116
Unit: s	Data Type: REAL	Access Type: Read/Write

P 5.8.6.5.6 S-Ramp 4 Decel. Increase Time

Description: Set the ramp deceleration increase time for S-ramp.

Default Value: 1	Parameter Type: Range (0 — 10000)	Parameter Number: 1120
Unit: s	Data Type: REAL	Access Type: Read/Write

P 5.8.6.5.7 S-Ramp 4 Decel. Decrease Time

Description: Set the ramp deceleration decrease time for S-ramp.

Default Value: 1	Parameter Type: Range (0 — 10000)	Parameter Number: 1124
Unit: s	Data Type: REAL	Access Type: Read/Write

6.6.10.9.7 Variable Ramp (Menu Index 5.8.6.6)

P 5.8.6.6.1 Accel. Time Input

Description: Select the input or a fixed value for adjusting the variable ramp acceleration time.

Default Value:	Parameter Type: Selection	Parameter Number: 1132
Unit: -	Data Type: UINT	Access Type: Read/Write

P 5.8.6.6.2 Accel. Time Maximum

Description: Set the maximum of the acceleration time for the variable ramp.

Default Value: 120	Parameter Type: Range (0 — 10000)	Parameter Number: 1134
Unit: s	Data Type: REAL	Access Type: Read/Write

P 5.8.6.6.3 Accel. Time Minimum

Description: Set the minimum of the acceleration time for the variable ramp.

Default Value: 0	Parameter Type: Range (0 — 10000)	Parameter Number: 1135
Unit: s	Data Type: REAL	Access Type: Read/Write

P 5.8.6.6.4 Decel. Time Input

Description: Select the input or a fixed value for adjusting the variable ramp deceleration time.

Default Value:	Parameter Type: Selection	Parameter Number: 1133
Unit: -	Data Type: UINT	Access Type: Read/Write

P 5.8.6.6.5 Decel. Time Maximum

Description: Set the maximum of the deceleration time for the variable ramp.

Default Value: 120	Parameter Type: Range (0 — 10000)	Parameter Number: 1136
Unit: s	Data Type: REAL	Access Type: Read/Write

P 5.8.6.6.6 Decel. Time Minimum

Description: Set the minimum of the deceleration time for the variable ramp.

Default Value: 0	Parameter Type: Range (0 — 10000)	Parameter Number: 1137
Unit: s	Data Type: REAL	Access Type: Read/Write

6.6.10.10 Speed Feedback (Menu Index 5.8.7)

P 5.8.7.1 Speed Feedback Filter Tc

Description: Set the speed feedback filter time constant (when the speed is controlled with speed sensor).

Default Value: 5.00	Parameter Type: Range (0.00 — 1000.00)	Parameter Number: 4544
Unit: ms	Data Type: REAL	Access Type: Read/Write

P 5.8.7.2 Estimated Speed Filter Tc

Description: Set the filter time constant for the estimated speed (when the speed is controlled without speed sensor).

Default Value: 10.00	Parameter Type: Range (5.00 — 100000.00)	Parameter Number: 4545
Unit: ms	Data Type: REAL	Access Type: Read/Write

P 5.8.7.3 Feedback Angle Offset

Description: Set the offset between permanent magnet (direct axis) angle and absolute feedback angle in the electrical domain. The offset value is summed with the feedback angle to attain the permanent magnet angle used in the control. Its correct setting is important when running FVC+ with synchronous motors in closed loop.

Default Value: 0	Parameter Type: Range (0 — 360)	Parameter Number: 9017
Unit: °	Data Type: REAL	Access Type: Read/Write

6.6.10.11 Speed Bypass Overview

Some systems call for some output frequencies to be avoided due to, for example, mechanical resonance problems. With the parameters of this group, a definition of the bandwidth around each of these parameters can be provided.

These parameters allow the setting of up to 4 speed bands that are avoided.

6.6.10.12 Speed Bypass (Menu Index 5.8.8)

P 5.8.8.1 Band 1, Low Limit

Description: Set the bypass hysteresis speed band, low limit.

Default Value: 0	Parameter Type: Range (0 — 100)	Parameter Number: 4520
Unit: Hz	Data Type: REAL	Access Type: Read/Write

P 5.8.8.2 Band 1, High Limit

Description: Set the bypass hysteresis speed band, high limit.

Default Value: 0	Parameter Type: Range (0 — 100)	Parameter Number: 4521
Unit: Hz	Data Type: REAL	Access Type: Read/Write

P 5.8.8.3 Band 2, Low Limit

Description: Set the bypass hysteresis speed band, low limit.

Default Value: 0	Parameter Type: Range (0 — 100)	Parameter Number: 4522
Unit: Hz	Data Type: REAL	Access Type: Read/Write

P 5.8.8.4 Band 2, High Limit

Description: Set the bypass hysteresis speed band, high limit.

Default Value: 0	Parameter Type: Range (0 — 100)	Parameter Number: 4523
Unit: Hz	Data Type: REAL	Access Type: Read/Write

P 5.8.8.5 Band 3, Low Limit

Description: Set the bypass hysteresis speed band, low limit.

Default Value: 0	Parameter Type: Range (0 — 100)	Parameter Number: 4524
Unit: Hz	Data Type: REAL	Access Type: Read/Write

P 5.8.8.6 Band 3, High Limit

Description: Set the bypass hysteresis speed band, high limit.

Default Value: 0	Parameter Type: Range (0 — 100)	Parameter Number: 4525
Unit: Hz	Data Type: REAL	Access Type: Read/Write

P 5.8.8.7 Band 4, Low Limit

Description: Set the bypass hysteresis speed band, low limit.

Default Value: 0	Parameter Type: Range (0 — 100)	Parameter Number: 4526
Unit: Hz	Data Type: REAL	Access Type: Read/Write

P 5.8.8.8 Band 4, High Limit

Description: Set the bypass hysteresis speed band, high limit.

Default Value: 0	Parameter Type: Range (0 — 100)	Parameter Number: 4527
Unit: Hz	Data Type: REAL	Access Type: Read/Write

6.6.10.13 Load Drooping (Menu Index 5.8.9)

P 5.8.9.1 Load Drooping Mode

Description: Select the load drooping mode - Only available in FVC+ mode.

Default Value: 0 [Static]	Parameter Type: Selection	Parameter Number: 670
Unit: -	Data Type: UINT	Access Type: Read/Write

The following are the selections for the parameter.

Selection Number	Selection Name	Selection Description
0	Static	Simple and robust drooping, but will result in a speed error on depending load.
1	Dynamic	This will run at correct speed independent of load, but requires synchronised start stop to avoid torque deviation between drives.
2	Combined	This will run a mix of static and dynamic drooping at low speed, otherwise identical with dynamic.

P 5.8.9.2 Load Drooping %

Description: Set the load drooping amount in % of nominal motor speed at nominal load conditions.

Default Value: 0	Parameter Type: Range (0 — 1000)	Parameter Number: 671
Unit: %	Data Type: REAL	Access Type: Read/Write

P 5.8.9.3 Load Drooping LP Tc

Description: Set the load drooping low pass filter time constant.

Default Value: 5.00	Parameter Type: Range (0.00 — 1000.00)	Parameter Number: 672
Unit: ms	Data Type: REAL	Access Type: Read/Write

P 5.8.9.4 Load Drooping HP Tc

Description: Set the load drooping high pass filter time constant. Only active in dynamic drooping mode.

Default Value: 1000.00	Parameter Type: Range (0.00 — 100000.00)	Parameter Number: 673
Unit: ms	Data Type: REAL	Access Type: Read/Write

P 5.8.9.5 Drooping Removal Mode

Description: Select the drooping removal mode.

Default Value: 0 [Constant droop]	Parameter Type: Selection	Parameter Number: 4581
Unit: -	Data Type: UINT	Access Type: Read/Write

The following are the selections for the parameter.

Selection Number	Selection Name	Selection Description
0	Constant droop	If Constant Droop is selected drooping removal functionality is disabled. Speed could be even reduced to opposite speed direction.
1	Below removal frequency	Drooping gain is reduced from removal frequency to zero. This mode protects from running opposite speed direction.
2	Linear below nom. speed	Drooping gain is reduced linear from nominal motor frequency to zero.

P 5.8.9.6 Drooping Removal Transition Speed

Description: Set the drooping removal transition speed.

Default Value: 1	Parameter Type: Range (0.001 — 1000)	Parameter Number: 4582
Unit: Hz	Data Type: REAL	Access Type: Read/Write

P 5.8.9.15 Enhanced Static Part

Description: Set the % of static drooping at speeds lower than the value set in "5.8.9.16 Enhanced Lower Transition Speed". 0% means dynamic drooping only and 100% static drooping only.

Default Value: 1.5	Parameter Type: Range (0 — 100)	Parameter Number: 675
Unit: %	Data Type: REAL	Access Type: Read/Write

P 5.8.9.16 Enhanced Lower Transition Speed

Description: Set the speed at which transition from combined static and dynamic drooping to dynamic drooping only starts.

Default Value: 589.999	Parameter Type: Range (0 — *)	Parameter Number: 676
Unit: Hz	Data Type: REAL	Access Type: Read/Write

P 5.8.9.17 Enhanced Higher Transition Speed

Description: Set the speed at which the transition from combined static and dynamic drooping to dynamic drooping only is complete.

Default Value: 590	Parameter Type: Range (* — *)	Parameter Number: 677
Unit: Hz	Data Type: REAL	Access Type: Read/Write

6.6.10.14 Auto Tuning (Menu Index 5.8.11)

P 5.8.11.1 Speed Controller Auto Tuning

Description: Enables the auto tuning of the speed controller. Auto tuning is started when the value of the parameter "5.3.2.4 System Inertia" is changed and unequal to "0".

Default Value: 0	Parameter Type: Range (False — True)	Parameter Number: 4546
Unit: -	Data Type: BOOL	Access Type: Read/Conditional Write

P 5.8.11.2 Auto Tuning Bandwidth

Description: Set the auto tuning bandwidth. A higher value leads to a faster response to speed or reference changes.

Default Value: 100	Parameter Type: Range (0 — 1000)	Parameter Number: 4547
Unit: %	Data Type: REAL	Access Type: Read/Write

P 5.8.11.3 System Friction

Description: Set the total system friction in % of the nominal motor torque at nominal motor speed.

Default Value: 0

Parameter Type: Range (0 — 100)

Parameter Number: 4548

Unit: %

Data Type: REAL

Access Type: Read/Write

6.6.11 Torque control (Menu Index 5.9)

6.6.11.1 Torque Control Overview

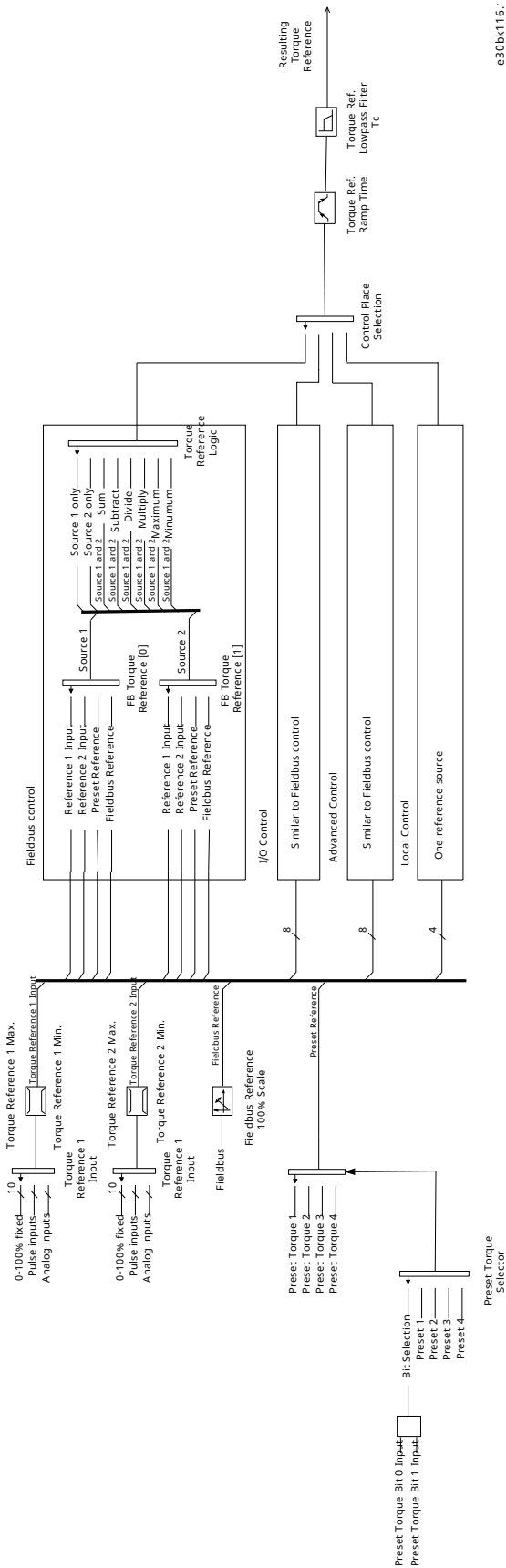

e30bk116

Figure 66: Reference Handling for Torque Control

While the drive is in torque control, motor speed is not controlled. Motor speed can reach speed limits, when the load application or upper system such as PLC system does not operate within the speed limits. If a speed limit is reached, the drive prevents itself from exceeding the limit depending on the selection in the parameter *Speed Limit Mode Torque Ctrl.* Detailed descriptions of the selections available in parameter *Speed Limit Mode Torque Ctrl.*

Pos./neg. frequency limit

By default, the selection for the parameter *Speed Limit Mode Torque Ctrl.* is *Pos./Neg. Frequency Limit.* While the drive is in torque control, the speed is not limited by the speed reference, only by the positive frequency limit and by the negative frequency limit.

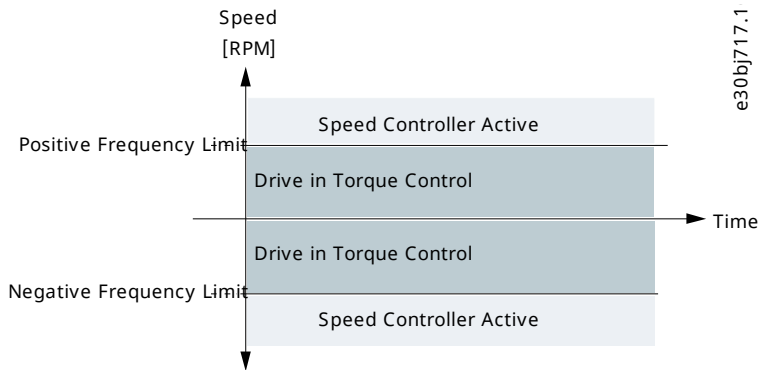

Figure 67: Pos./Neg. Frequency Limit

Limited by ramp

While the drive is in torque control, the speed is limited by the reference (after ramp). The speed increases with the set ramp time until actual torque is equal to the torque reference. If the speed is below the reference when load is removed from the shaft the speed increases without ramp.

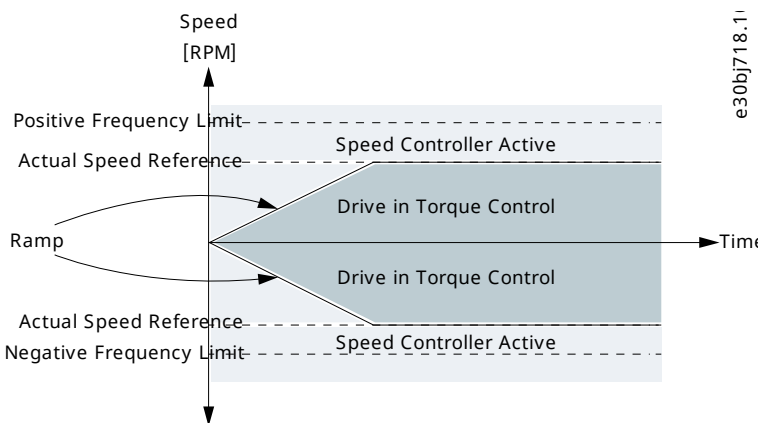

Figure 68: Limited by Ramp

Neg. limit to ramp

The torque controller operates in the range between the frequency limit for the negative direction and the speed limit given by the ramp.

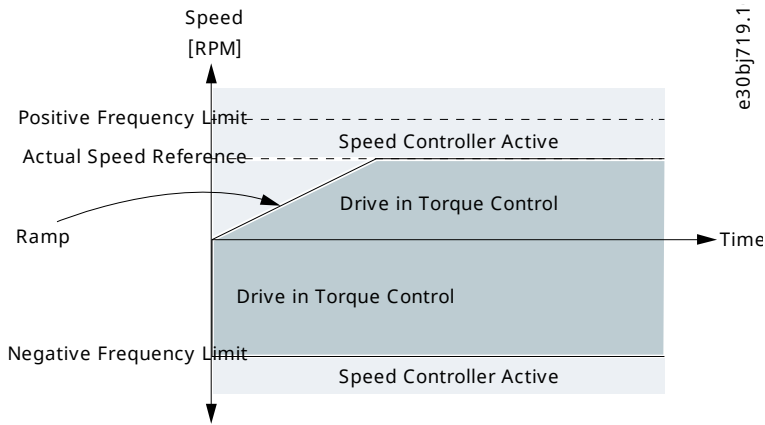

Figure 69: Neg. Limit to Ramp

Ramp to max. limit

The maximum of the speed controller output and the torque reference is selected as final torque reference. The torque controller operates in the range between the frequency limit for the positive direction and the speed limit given by the ramp.

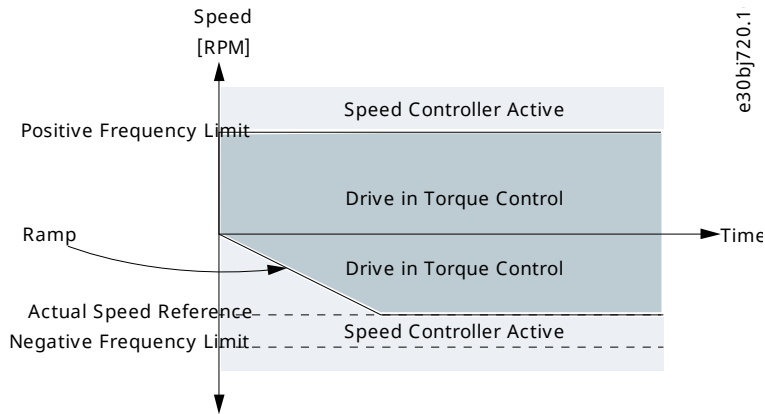

Figure 70: Ramp to Max. Limit

Window

Torque control is active within a speed window around the speed reference. Speed control activation limit is different from the speed limit. Therefore speed is required to reach first to upper or lower window limit before the speed controller activates.

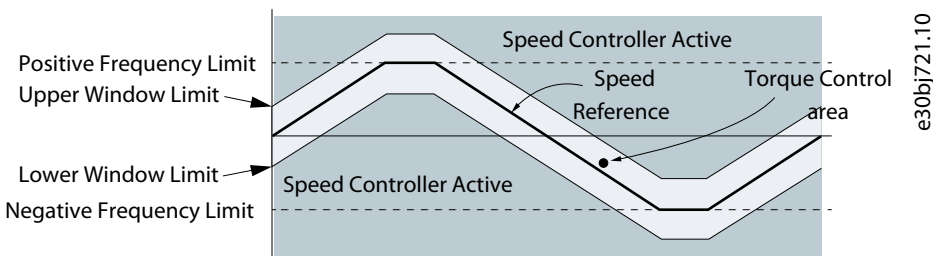

Figure 71: Window

6.6.11.2 Torque Control Status (Menu Index 5.9.1)

P 5.9.1.1 Motor Torque

Description: Shows the actual motor torque.

Default Value: NA	Parameter Type: Range (-10000000 — 10000000)	Parameter Number: 9009
Unit: Nm	Data Type: REAL	Access Type: Read Only

P 5.9.1.2 Relative Motor Torque

Description: Shows the motor torque in % of the nominal motor torque.

Default Value: NA	Parameter Type: Range (* — *)	Parameter Number: 1708
Unit: %	Data Type: REAL	Access Type: Read Only

P 5.9.1.3 Torque Limit Motoring

Description: Shows the torque limit in motoring mode in % of nominal motor torque.

Default Value: NA	Parameter Type: Range (0 — 500)	Parameter Number: 1812
Unit: %	Data Type: REAL	Access Type: Read/Write

P 5.9.1.4 Torque Limit Regenerative

Description: Shows the regenerative torque limit in % of nominal motor torque.

Default Value: NA	Parameter Type: Range (0 — 500)	Parameter Number: 1813
Unit: %	Data Type: REAL	Access Type: Read/Write

P 5.9.1.5 Local Torque Reference

Description: Shows the local torque reference set in the control panel.

Default Value: NA	Parameter Type: Range (-300 — 300)	Parameter Number: 6155
Unit: %	Data Type: REAL	Access Type: Read/Write

P 5.9.1.6 Torque Reference

Description: Shows the value of the current torque reference in the reference chain in % of nominal motor torque.

Default Value: NA	Parameter Type: Range (-300 — 300)	Parameter Number: 6152
Unit: %	Data Type: REAL	Access Type: Read/Write

P 5.9.1.7 Torque Reference Final

Description: Shows the value of the final torque reference given to the motor controller in % of nominal motor torque.

Default Value: NA	Parameter Type: Range (-300 — 300)	Parameter Number: 6154
Unit: %	Data Type: REAL	Access Type: Read Only

6.6.11.3 Limits (Menu Index 5.9.2)

P 5.9.2.1 Positive Torque Limit

Description: Set the positive torque limit (quadrants 1 and 2) in % of nominal motor torque.

Default Value: 300	Parameter Type: Range (0 — 500)	Parameter Number: 1810
Unit: %	Data Type: REAL	Access Type: Read/Write

P 5.9.2.2 Negative Torque Limit

Description: Set the negative torque limit (quadrants 3 and 4) in % of nominal motor torque.

Default Value: -300	Parameter Type: Range (-500 — 0)	Parameter Number: 1811
Unit: %	Data Type: REAL	Access Type: Read/Write

P 5.9.2.3 Motoring Torque Limit

Description: Set the torque limit in motoring mode (quadrants 1 and 3) in % of nominal motor torque.

Default Value: 300	Parameter Type: Range (0 — 500)	Parameter Number: 1321
Unit: %	Data Type: REAL	Access Type: Read/Write

P 5.9.2.4 Regenerative Torque Limit

Description: Set the torque limit in regenerative mode (quadrants 2 and 4) in % of nominal motor torque.

Default Value: 300	Parameter Type: Range (0 — 500)	Parameter Number: 1323
Unit: %	Data Type: REAL	Access Type: Read/Write

P 5.9.2.5 Speed Limit Mode Torque Ctrl.

Description: Select the speed limiting mode during torque control.

Default Value: 0 [Pos./Neg. Speed Limit]	Parameter Type: Selection	Parameter Number: 2332
Unit: -	Data Type: UINT	Access Type: Read/Conditional Write

The following are the selections for the parameter.

Selection Number	Selection Name	Selection Description
0	Pos./Neg. Speed Limit	Limit between positive and negative speed limit.
1	Speed Limit Setpoint	Limit between +/- speed limit setpoint.
2	Window around Speed Limit Setpoint	Limit window around torque mode speed limit.

P 5.9.2.6 Lower Window Limit

Description: Set the window size towards the positive speed direction.

Default Value: 0	Parameter Type: Range (0 — 10)	Parameter Number: 2333
Unit: Hz	Data Type: REAL	Access Type: Read/Write

P 5.9.2.7 Upper Window Limit

Description: Set the window size towards the negative speed direction.

Default Value: 0	Parameter Type: Range (0 — 10)	Parameter Number: 2334
Unit: Hz	Data Type: REAL	Access Type: Read/Write

P 5.9.2.26 Speed Limit Setpoint

Description: Set the variable speed limit setpoint in torque mode. This is used when fixed speed limits are not desired.

Default Value: 50	Parameter Type: Range (0 — 1000)	Parameter Number: 1336
Unit: Hz	Data Type: REAL	Access Type: Read/Write

P 5.9.2.27 Speed Limit Setpoint Ramp Time

Description: Set the speed limit setpoint ramp time. When running in speed limit in torque mode, the drive will accelerate/decelerate towards the speed limit setpoint using this ramp time.

Default Value: 5	Parameter Type: Range (0 — 10000)	Parameter Number: 1337
Unit: s	Data Type: REAL	Access Type: Read/Write

P 5.9.2.28 Motoring Torque Limit Scale Input

Description: Select the input for scaling motoring torque limit between 0% and 100% value defined in motoring torque limit. Off equals 100%.

Default Value:	Parameter Type: Selection	Parameter Number: 1324
Unit: -	Data Type: UINT	Access Type: Read/Write

P 5.9.2.29 Regenerative Torque Limit Scale Input

Description: Select the input for scaling regenerative torque limit between 0% and 100% value defined in regenerative torque limit. Off equals 100%.

Default Value:	Parameter Type: Selection	Parameter Number: 1326
Unit: -	Data Type: UINT	Access Type: Read/Write

P 5.9.2.30 Negative Torque Limit Scale Input

Description: Select the input for scaling negative torque limit between 0% and 100% value defined in negative torque limit. Off equals 100%.

Default Value:	Parameter Type: Selection	Parameter Number: 1330
Unit: -	Data Type: UINT	Access Type: Read/Write

P 5.9.2.31 Positive Torque Limit Scale Input

Description: Select the input for scaling positive torque limit between 0% and 100% value defined in positive torque limit. Off equals 100%.

Default Value:	Parameter Type: Selection	Parameter Number: 1333
Unit: -	Data Type: UINT	Access Type: Read/Write

P 5.9.2.32 Speed Limit setpoint Scale Input

Description: Select the input for scaling speed limit setpoint in torque mode between 0% and 100% of parameter value. Off equals 100%.

Default Value:	Parameter Type: Selection	Parameter Number: 1334
Unit: -	Data Type: UINT	Access Type: Read/Write

P 5.9.2.33 Motoring Torque Limit Response

Description: Select the response for running in motoring torque limit after the time delay defined.

Default Value: 0 [No response]	Parameter Type: Selection	Parameter Number: 2361
Unit: -	Data Type: UINT	Access Type: Read/Write

The following are the selections for the parameter.

Selection Number	Selection Name	Selection Description
0	No response	The event is ignored.
1	Info	The event is logged in the event log.
10	Fault	The drive issues a fault and coasts the motor.

P 5.9.2.34 Motoring Torque Limit Delay

Description: Set the delay the drive is allowed to be in motoring torque limit before a response is issued.

Default Value:	Parameter Type: Range (0 — 65000)	Parameter Number: 2358
Unit: s	Data Type: REAL	Access Type: Read/Write

P 5.9.2.35 Regenerative Torque Limit Response

Description: Select the response for running in regenerative torque limit after the time delay defined.

Default Value: 0 [No response]	Parameter Type: Selection	Parameter Number: 2362
Unit: -	Data Type: UINT	Access Type: Read/Write

The following are the selections for the parameter.

Selection Number	Selection Name	Selection Description
0	No response	The event is ignored.
1	Info	The event is logged in the event log.
10	Fault	The drive issues a fault and coasts the motor.

P 5.9.2.36 Regenerative Torque Limit Delay

Description: Set the delay the drive is allowed to be in regenerative torque limit before a response is issued.

Default Value:	Parameter Type: Range (0 — 65000)	Parameter Number: 2363
Unit: s	Data Type: REAL	Access Type: Read/Write

6.6.11.4 Torque Reference (Menu Index 5.9.3)

P 5.9.3.1 Torque Reference 1 Input

Description: Select the input terminal or a predefined fixed value for the torque reference.

Default Value:	Parameter Type: Selection	Parameter Number: 4534
Unit: -	Data Type: UINT	Access Type: Read/Write

P 5.9.3.2 Torque Reference 2 Input

Description: Select the input terminal or a predefined fixed value for the torque reference.

Default Value:	Parameter Type: Selection	Parameter Number: 4535
Unit: -	Data Type: UINT	Access Type: Read/Write

P 5.9.3.3 Torque Reference 1 Max.

Description: Set the maximum torque reference value in % of nominal motor torque.

Default Value: 100	Parameter Type: Range (-300 — 300)	Parameter Number: 4530
Unit: %	Data Type: REAL	Access Type: Read/Write

P 5.9.3.4 Torque Reference 1 Min.

Description: Set the minimum torque reference value in % of nominal motor torque.

Default Value: 0	Parameter Type: Range (-300 — 300)	Parameter Number: 4531
Unit: %	Data Type: REAL	Access Type: Read/Write

P 5.9.3.5 Torque Reference 2 Max.

Description: Set the maximum torque reference value in % of nominal motor torque.

Default Value: 100	Parameter Type: Range (-300 — 300)	Parameter Number: 4532
Unit: %	Data Type: REAL	Access Type: Read/Write

P 5.9.3.6 Torque Reference 2 Min.

Description: Set the torque minimum reference value in % of nominal motor torque.

Default Value: 0	Parameter Type: Range (-300 — 300)	Parameter Number: 4533
Unit: %	Data Type: REAL	Access Type: Read/Write

P 5.9.3.7 Preset Torque Selector

Description: Select the preset torque number.

Default Value: 1 [Preset 1]	Parameter Type: Selection	Parameter Number: 724
Unit: -	Data Type: UINT	Access Type: Read/Write

The following are the selections for the parameter.

Selection Number	Selection Name	Selection Description
0	Bit Selection	Use digital inputs to select the preset reference number.
1	Preset 1	Use preset 1.
2	Preset 2	Use preset 2.
3	Preset 3	Use preset 3.
4	Preset 4	Use preset 4.

P 5.9.3.8 Preset Torque 1

Description: Set the torque preset value in % of the nominal motor torque.

Default Value: 10	Parameter Type: Range (-300 — 300)	Parameter Number: 725
Unit: %	Data Type: REAL	Access Type: Read/Write

P 5.9.3.9 Preset Torque 2

Description: Set the torque preset value in % of the nominal motor torque.

Default Value: 25	Parameter Type: Range (-300 — 300)	Parameter Number: 726
Unit: %	Data Type: REAL	Access Type: Read/Write

P 5.9.3.10 Preset Torque 3

Description: Set the torque preset value in % of the nominal motor torque.

Default Value: 50	Parameter Type: Range (-300 — 300)	Parameter Number: 727
Unit: %	Data Type: REAL	Access Type: Read/Write

P 5.9.3.11 Preset Torque 4

Description: Set the torque preset value in % of the nominal motor torque.

Default Value: 100	Parameter Type: Range (-300 — 300)	Parameter Number: 728
Unit: %	Data Type: REAL	Access Type: Read/Write

P 5.9.3.12 Preset Torque Bit 0 Input

Description: Select the digital input used as bit 0 addressing the preset reference.

Default Value:	Parameter Type: Selection	Parameter Number: 721
Unit: -	Data Type: UINT	Access Type: Read/Write

P 5.9.3.13 Preset Torque Bit 1 Input

Description: Select the digital input used as bit 1 addressing the preset reference.

Default Value:	Parameter Type: Selection	Parameter Number: 722
Unit: -	Data Type: UINT	Access Type: Read/Write

P 5.9.3.14 Torque Reference Ramp Time

Description: Set the ramping time from 0 to nominal motor torque.

Default Value: 0	Parameter Type: Range (0 — 10000)	Parameter Number: 2330
Unit: s	Data Type: REAL	Access Type: Read/Write

P 5.9.3.15 Torque Ref. Lowpass Filter Tc

Description: Set the time constant of the reference filter. Setting it to 0 disables the filter.

Default Value: 0.00	Parameter Type: Range (0.00 — 1000000.00)	Parameter Number: 2335
Unit: ms	Data Type: REAL	Access Type: Read/Write

6.6.11.5 Additional Information on Torque Reference

P 5.9.3.1 Torque Reference 1 Input

Note: Selection lists with inputs and/or outputs consist of the name of the hardware option and the numbers of the terminals. For example, terminal number 13 of the Basic I/O is called Basic I/O T13 in the selection list.

P 5.9.3.2 Torque Reference 2 Input

Note: Selection lists with inputs and/or outputs consist of the name of the hardware option and the numbers of the terminals. For example, terminal number 13 of the Basic I/O is called Basic I/O T13 in the selection list.

P 5.9.3.12 Preset Torque Bit 0 Input

Note: Selection lists with inputs and/or outputs consist of the name of the hardware option and the numbers of the terminals. For example, terminal number 13 of the Basic I/O is called Basic I/O T13 in the selection list.

P 5.9.3.13 Preset Torque Bit 1 Input

Note: Selection lists with inputs and/or outputs consist of the name of the hardware option and the numbers of the terminals. For example, terminal number 13 of the Basic I/O is called Basic I/O T13 in the selection list.

6.6.12 Process Control (Menu Index 5.10)

6.6.12.1 Process Control Overview

The process controller enables maintaining process parameters such as temperature, pressure, and flow within a specified range or at a desired value. This is achieved by controlling the output frequency of the drive based on continuous measurement of the actual value of the process parameter (feedback) and the comparison of the process parameter with a setpoint.

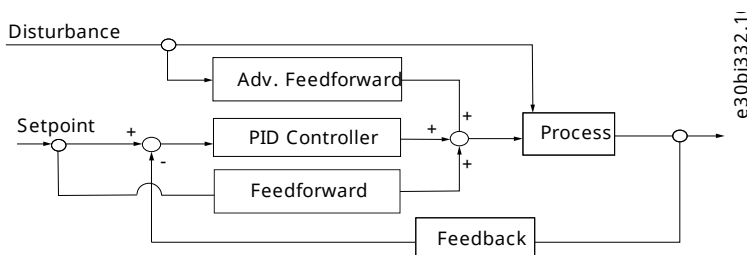

Figure 72: Process Controller

The embedded process controller features the following:

- Adjustable proportional gain, Integral time, and Derivative time
- Auto-tuning of the controller
- Bumpless operation
- 8 preset references
- 2 reference sources which can be combined
- Feedforward control
- Inverse control
- 2 feedback sources (analog inputs and fieldbus)
- Feedback calculations including sum, difference, average, minimum, and maximum

- Anti-windup
- Low-pass filtering of setpoint or feedback
- Status of the most important process parameters

6.6.12.2 Process Control Status (Menu Index 5.10.1)

P 5.10.1.1 On Reference

Description: Shows if the controlled process is operating on the current reference.

Default Value: NA	Parameter Type: Range (0 — 1)	Parameter Number: 6074
Unit: -	Data Type: BOOL	Access Type: Read Only

P 5.10.1.2 Process Controller Output

Description: Shows the process controller's output as normalized value (in the range 0 to 1).

Default Value: NA	Parameter Type: Range (-1000000 — 1000000)	Parameter Number: 6075
Unit: -	Data Type: REAL	Access Type: Read Only

P 5.10.1.3 Setpoint Value

Description: Shows the actual value of the setpoint.

Default Value: NA	Parameter Type: Range (-1000000 — 1000000)	Parameter Number: 6092
Unit: -	Data Type: REAL	Access Type: Read Only

P 5.10.1.4 Feedback Value

Description: Shows the actual value of the feedback.

Default Value: NA	Parameter Type: Range (* — *)	Parameter Number: 6090
Unit: CustomProcessUnit	Data Type: REAL	Access Type: Read Only

P 5.10.1.5 Adv. Feedforward Value

Description: Shows the actual value of the advanced feedforward.

Default Value: NA	Parameter Type: Range (-1000000 — 1000000)	Parameter Number: 6086
Unit: -	Data Type: REAL	Access Type: Read Only

P 5.10.1.6 Feedback 1 Value

Description: Shows the actual value of feedback 1.

Default Value: NA	Parameter Type: Range (-1000000 — 1000000)	Parameter Number: 6080
Unit: -	Data Type: REAL	Access Type: Read Only

P 5.10.1.7 Feedback 2 Value

Description: Shows the actual value of feedback 2.

Default Value: NA	Parameter Type: Range (-1000000 — 1000000)	Parameter Number: 6085
Unit: CustomProcessUnit	Data Type: REAL	Access Type: Read Only

P 5.10.1.9 Control Panel Process Reference

Description: Shows the value of the process reference given from the control panel.

Default Value: NA	Parameter Type: Range (-1000000 — 1000000)	Parameter Number: 6094
Unit: CustomProcessUnit	Data Type: REAL	Access Type: Read/Write

P 5.10.1.10 Process Controller Enabled

Description: Enables the process controller.

Default Value: NA	Parameter Type: Range (0 — 1)	Parameter Number: 6053
Unit: -	Data Type: BOOL	Access Type: Read Only

6.6.12.3 General Settings (Menu Index 5.10.2)

P 5.10.2.1 On Reference Relative Tolerance

Description: Set the bandwidth for "On Reference" as % of the set point. If the control error is less than the defined percentage of the set point the "On Reference" flag is true. The tolerance used is the highest value of the absolute and relative reference.

Default Value: 0.01	Parameter Type: Range (0 — 1)	Parameter Number: 6050
Unit: PercentageFromFraction	Data Type: REAL	Access Type: Read/Write

P 5.10.2.2 On Reference Absolute Tolerance

Description: Set the bandwidth for "On Reference" as an absolute value. If the control error is less than the defined percentage of the set point the "On Reference" flag is true. The tolerance used is the highest value of the absolute and relative reference.

Default Value: 0.01	Parameter Type: Range (0 — 100000)	Parameter Number: 6064
Unit: -	Data Type: REAL	Access Type: Read/Write

P 5.10.2.3 Process Unit

Description: Unit of the Process Controller references and feedbacks (no automatic conversion is done when changing the value of this parameter).

Default Value: 31 []	Parameter Type: Selection	Parameter Number: 6628
Unit: -	Data Type: USINT	Access Type: Read/Write

The following are the selections for the parameter.

Selection Number	Selection Name	Selection Description
31		Process Unit (No Unit or Custom Process Unit).
0	mbar	Pressure in millibars.
1	bar	Pressure in bars.
2	Pa	Pressure in pascals.
3	kPa	Pressure in kilopascals.
4	l/s	Liters per second.
5	l/min	Liters per minute.
6	l/h	Liters per hour.
7	m ³ /s	Cubic meters per second.
8	m ³ /min	Cubic meters per minute.
9	m ³ /h	Cubic meters per hour.
10	U.S. gallon/s (GPS)	U.S. gallons per second.
11	U.S. gallon/min (GPM)	U.S. gallons per minute.
12	U.S. gallon/h (GPH)	U.S. gallons per hour.
13	in ³ /s	Cubic inches per second.
14	in ³ /min	Cubic inches per minute.
15	in ³ /h	Cubic inches per hour.
16	ft ³ /s	Cubic feet per second.
17	ft ³ /min	Cubic feet per minute.
18	ft ³ /h	Cubic feet per hour.
19	m WG	Meter water gauge.
20	mm Hg	Millimeters of mercury.
21	°C	Degrees Celcius.
22	°F	Degrees Fahrenheit.
23	kg/s	Kilograms per second.
24	kg/min	Kilograms per minute.

Selection Number	Selection Name	Selection Description
25	kg/h	Kilograms per hour.
26	t/min	Tons per minute.
27	t/h	Tons per hour.
28	m/s	Meters per second.
29	m/min	Meters per minute.
30	m/h	Meters per hour.

6.6.12.4 Process Reference (Menu Index 5.10.3)

P 5.10.3.1 Process Reference Max. Limit

Description: Set the maximum value of the reference. It defines the upper point for the limiting of the reference input.

Default Value: 10	Parameter Type: Range (-1000000 — 1000000)	Parameter Number: 6013
Unit: CustomProcessUnit	Data Type: REAL	Access Type: Read/Write

P 5.10.3.2 Process Reference Min. Limit

Description: Set the minimum value of the reference. It defines the lower point for the limiting of the reference input.

Default Value: 0	Parameter Type: Range (-1000000 — 1000000)	Parameter Number: 6014
Unit: CustomProcessUnit	Data Type: REAL	Access Type: Read/Write

P 5.10.3.3 Process Reference 1 Input

Description: Select the input terminal or a predefined fixed value for the process reference.

Default Value:	Parameter Type: Selection	Parameter Number: 6025
Unit: -	Data Type: UINT	Access Type: Read/Write

P 5.10.3.4 Process Reference 2 Input

Description: Select the input terminal or a predefined fixed value for the the process reference.

Default Value:	Parameter Type: Selection	Parameter Number: 6026
Unit: -	Data Type: UINT	Access Type: Read/Write

P 5.10.3.5 Process Reference 1 Min.

Description: Set the minimum process reference for the input.

Default Value: 0	Parameter Type: Range (-1000000 — 1000000)	Parameter Number: 6047
Unit: CustomProcessUnit	Data Type: REAL	Access Type: Read/Write

P 5.10.3.6 Process Reference 1 Max.

Description: Set the maximum process reference for the input.

Default Value: 10	Parameter Type: Range (-1000000 — 1000000)	Parameter Number: 6048
Unit: CustomProcessUnit	Data Type: REAL	Access Type: Read/Write

P 5.10.3.7 Process Reference 2 Min.

Description: Set the minimum process reference for the input.

Default Value: 0	Parameter Type: Range (-1000000 — 1000000)	Parameter Number: 6033
Unit: CustomProcessUnit	Data Type: REAL	Access Type: Read/Write

P 5.10.3.8 Process Reference 2 Max.

Description: Set the maximum process reference for the input.

Default Value: 10	Parameter Type: Range (-1000000 — 1000000)	Parameter Number: 6029
Unit: CustomProcessUnit	Data Type: REAL	Access Type: Read/Write

P 5.10.3.9 Preset Process Reference Selector

Description: Select the preset reference. The preset reference can be selected as a fixed value or by 3 digital inputs.

Default Value: 1 [Preset 1]	Parameter Type: Selection	Parameter Number: 6032
Unit: -	Data Type: UINT	Access Type: Read/Write

The following are the selections for the parameter.

Selection Number	Selection Name	Selection Description
0	Bit Selection	Use digital inputs to select the preset reference number.
1	Preset 1	Use preset 1.
2	Preset 2	Use preset 2.
3	Preset 3	Use preset 3.
4	Preset 4	Use preset 4.

Selection Number	Selection Name	Selection Description
5	Preset 5	Use preset 5.
6	Preset 6	Use preset 6.
7	Preset 7	Use preset 7.
8	Preset 8	Use preset 8.

P 5.10.3.10 Preset Process Ref. Bit 0 Input

Description: Select the digital input used as bit 0 addressing the preset reference.

Default Value:	Parameter Type: Selection	Parameter Number: 6034
Unit: -	Data Type: UINT	Access Type: Read/Write

P 5.10.3.11 Preset Process Ref. Bit 1 Input

Description: Select the digital input used as bit 1 addressing the preset reference.

Default Value:	Parameter Type: Selection	Parameter Number: 6035
Unit: -	Data Type: UINT	Access Type: Read/Write

P 5.10.3.12 Preset Process Ref. Bit 2 Input

Description: Select the digital input used as bit 2 addressing the preset reference.

Default Value:	Parameter Type: Selection	Parameter Number: 6036
Unit: -	Data Type: UINT	Access Type: Read/Write

P 5.10.3.13 Preset Process Ref. 1

Description: Set the value of the preset reference.

Default Value: 1	Parameter Type: Range (-1000000 — 1000000)	Parameter Number: 6037
Unit: CustomProcessUnit	Data Type: REAL	Access Type: Read/Write

P 5.10.3.14 Preset Process Ref. 2

Description: Set the value of the preset reference.

Default Value: 2	Parameter Type: Range (-1000000 — 1000000)	Parameter Number: 6038
Unit: CustomProcessUnit	Data Type: REAL	Access Type: Read/Write

P 5.10.3.15 Preset Process Ref. 3

Description: Set the value of the preset reference.

Default Value: 3	Parameter Type: Range (-1000000 — 1000000)	Parameter Number: 6039
Unit: CustomProcessUnit	Data Type: REAL	Access Type: Read/Write

P 5.10.3.16 Preset Process Ref. 4

Description: Set the value of the preset reference.

Default Value: 4	Parameter Type: Range (-1000000 — 1000000)	Parameter Number: 6040
Unit: CustomProcessUnit	Data Type: REAL	Access Type: Read/Write

P 5.10.3.17 Preset Process Ref. 5

Description: Set the value of the preset reference.

Default Value: 5	Parameter Type: Range (-1000000 — 1000000)	Parameter Number: 6041
Unit: CustomProcessUnit	Data Type: REAL	Access Type: Read/Write

P 5.10.3.18 Preset Process Ref. 6

Description: Set the value of the preset reference.

Default Value: 6	Parameter Type: Range (-1000000 — 1000000)	Parameter Number: 6042
Unit: CustomProcessUnit	Data Type: REAL	Access Type: Read/Write

P 5.10.3.19 Preset Process Ref. 7

Description: Set the value of the preset reference.

Default Value: 7	Parameter Type: Range (-1000000 — 1000000)	Parameter Number: 6043
Unit: CustomProcessUnit	Data Type: REAL	Access Type: Read/Write

P 5.10.3.20 Preset Process Ref. 8

Description: Set the value of the preset reference.

Default Value: 8	Parameter Type: Range (-1000000 — 1000000)	Parameter Number: 6044
Unit: CustomProcessUnit	Data Type: REAL	Access Type: Read/Write

P 5.10.3.21 Process Ref. Ramp Rise Time

Description: Set the rising rate of the ramp for the setpoint.

Default Value: 10000	Parameter Type: Range (0 — 1000000)	Parameter Number: 6005
Unit: -	Data Type: REAL	Access Type: Read/Write

P 5.10.3.22 Process Ref. Ramp Fall Time

Description: Set the falling rate of the ramp for the setpoint.

Default Value: 10000	Parameter Type: Range (0 — 1000000)	Parameter Number: 6006
Unit: -	Data Type: REAL	Access Type: Read/Write

P 5.10.3.23 Process Ref. Lowpass Filter Tc

Description: Set the time constant of the reference filter. Setting it to 0 disables the filter.

Default Value: 0.00	Parameter Type: Range (0.00 — 30000.00)	Parameter Number: 6083
Unit: ms	Data Type: REAL	Access Type: Read/Write

P 5.10.3.24 Process Controller Start Speed

Description: Set the start speed of the process controller.

Default Value: 0	Parameter Type: Range (-1000 — 1000)	Parameter Number: 6056
Unit: Hz	Data Type: REAL	Access Type: Read/Write

P 5.10.3.26 Fieldbus Process Reference Scale

Description: Set the fieldbus reference scale equal to 100% reference.

Default Value: 10	Parameter Type: Range (-1000000 — 1000000)	Parameter Number: 6030
Unit: CustomProcessUnit	Data Type: REAL	Access Type: Read/Write

6.6.12.5 Additional Information on Process Reference

P 5.10.3.22 Process Ref. Ramp Fall Time

Editing the setpoint falling time ramp defines the ramp-down time. The falling ramp for the setpoint is defined as slew rates which refers to process unit per time such as bar/s, °C/s. Setting the parameter to high values (compared to the dynamics of the requested setpoint) disables the ramp-down function.

6.6.12.6 Feedback (Menu Index 5.10.4)

P 5.10.4.1 Feedback Mode

Description: Select the function to combine feedback 1 and feedback 2.

Default Value: 0 [Feedback 1]	Parameter Type: Selection	Parameter Number: 6008
Unit: -	Data Type: UINT	Access Type: Read/Write

The following are the selections for the parameter.

Selection Number	Selection Name	Selection Description
0	Feedback 1	Use value from feedback source 1 only.
1	Feedback 2	Use value from feedback source 2 only.
2	Sum	Add references from source 1 and 2 together.
3	Difference	Subtract source 2 from source 1.
4	Average	Average value of source 1 and 2.
5	Minimum	Use lowest value of source 1 and source 2.
6	Maximum	Use highest value of source 1 and source 2.

P 5.10.4.2 Feedback 1 Type

Description: Select the type of feedback.

Default Value: 1 [Analog Feedback Terminal]	Parameter Type: Selection	Parameter Number: 6021
Unit: -	Data Type: UINT	Access Type: Read/Write

The following are the selections for the parameter.

Selection Number	Selection Name	Selection Description
0	Feedback disabled	
1	Analog Feedback Terminal	Use feedback value from the analog input.
2	Fieldbus Feedback	Use feedback value from the fieldbus.

P 5.10.4.3 Feedback 1 Maximum Scaling

Description: Set the maximum scaling value of the feedback.

Default Value: 10	Parameter Type: Range (-1000000 — 1000000)	Parameter Number: 6015
Unit: CustomProcessUnit	Data Type: REAL	Access Type: Read/Write

P 5.10.4.4 Feedback 1 Minimum Scaling

Description: Set the minimum scaling value of the feedback.

Default Value: 0	Parameter Type: Range (-1000000 — 1000000)	Parameter Number: 6016
Unit: CustomProcessUnit	Data Type: REAL	Access Type: Read/Write

P 5.10.4.5 Analog Input Feedback 1

Description: Select the input or a predefined fixed value for the feedback.

Default Value:	Parameter Type: Selection	Parameter Number: 6027
Unit: -	Data Type: UINT	Access Type: Read/Write

P 5.10.4.6 Feedback 1 Conversion

Description: Select a conversion function for the feedback.

Default Value: 0 [Linear]	Parameter Type: Selection	Parameter Number: 6009
Unit: -	Data Type: UINT	Access Type: Read/Write

The following are the selections for the parameter.

Selection Number	Selection Name	Selection Description
0	Linear	The fieldbus reference will be scaled linearly.
1	Quadratic	The fieldbus reference will be scaled quadratically (ref ²).

P 5.10.4.7 Feedback 2 Type

Description: Select the type of feedback.

Default Value: 0 [Feedback disabled]	Parameter Type: Selection	Parameter Number: 6022
Unit: -	Data Type: UINT	Access Type: Read/Write

The following are the selections for the parameter.

Selection Number	Selection Name	Selection Description
0	Feedback disabled	
1	Analog Feedback Terminal	Use feedback value from the analog input.
2	Fieldbus Feedback	Use feedback value from the fieldbus.

P 5.10.4.8 Feedback 2 Maximum Scaling

Description: Set the maximum scaling value of the feedback.

Default Value: 100	Parameter Type: Range (-1000000 — 1000000)	Parameter Number: 6017
Unit: CustomProcessUnit	Data Type: REAL	Access Type: Read/Write

P 5.10.4.9 Feedback 2 Minimum Scaling

Description: Set the minimum scaling value of the feedback.

Default Value: 0	Parameter Type: Range (-1000000 — 1000000)	Parameter Number: 6018
Unit: CustomProcessUnit	Data Type: REAL	Access Type: Read/Write

P 5.10.4.10 Analog Input Feedback 2

Description: Set the input for the feedback.

Default Value:	Parameter Type: Selection	Parameter Number: 6028
Unit: -	Data Type: UINT	Access Type: Read/Write

P 5.10.4.11 Feedback 2 Conversion

Description: Select a conversion function for the feedback.

Default Value: 0 [Linear]	Parameter Type: Selection	Parameter Number: 6010
Unit: -	Data Type: UINT	Access Type: Read/Write

The following are the selections for the parameter.

Selection Number	Selection Name	Selection Description
0	Linear	The fieldbus reference will be scaled linearly.
1	Quadratic	The fieldbus reference will be scaled quadratically (ref ²).

P 5.10.4.17 Feedback Filter Tc

Description: Set the time constant of the feedback filter.

Default Value: 0.00	Parameter Type: Range (0.00 — 30000.00)	Parameter Number: 6084
Unit: ms	Data Type: REAL	Access Type: Read/Write

6.6.12.7 PID Controller (Menu Index 5.10.5)

P 5.10.5.1 Proportional Gain

Description: Set the propoportional gain of the PID controller.

Default Value: 10	Parameter Type: Range (0 — 100000)	Parameter Number: 6065
Unit: -	Data Type: REAL	Access Type: Read/Write

P 5.10.5.2 Integral Time

Description: Set the integral time of the PID controller.

Default Value: 1	Parameter Type: Range (0 — 1000000)	Parameter Number: 6058
Unit: s	Data Type: REAL	Access Type: Read/Write

P 5.10.5.3 Integral Reset

Description: Resets the I-part of the PID controller. The selection automatically returns to false. Resetting the I-part makes it possible to start from a well-defined point after changing something in the process.

Default Value: 0	Parameter Type: Range (0 — 1)	Parameter Number: 6060
Unit: -	Data Type: BOOL	Access Type: Read/Write

P 5.10.5.4 Antiwindup Enabled

Description: Enables antiwindup which ceases the regulation of an error, when the minimum or maximum speed has been reached.

Default Value: 1	Parameter Type: Range (0 — 1)	Parameter Number: 6061
Unit: -	Data Type: BOOL	Access Type: Read/Write

P 5.10.5.5 Derivative Time

Description: Set the derivative time of the PID controller. The differentiator does not react to a constant error, but provides a gain only when the error changes. The shorter the PID differentiation time, the stronger the gain from the differentiator. When set to 0 the derivative part is disabled.

Default Value: 0	Parameter Type: Range (0 — 1000)	Parameter Number: 6068
Unit: s	Data Type: REAL	Access Type: Read/Write

P 5.10.5.6 Derivative Gain

Description: Set a limit for the differentiator gain. If there is no limit, the differentiator gain increases when there are fast changes. To obtain a pure differentiator gain at slow changes and a constant differentiator gain where fast changes occur, limit the differentiator gain.

Default Value: 5	Parameter Type: Range (1 — 100)	Parameter Number: 6069
Unit: -	Data Type: REAL	Access Type: Read/Write

P 5.10.5.7 PID Inverted

Description: Inverts the output of the PID controller.

Default Value: 0	Parameter Type: Range (0 — 1)	Parameter Number: 6066
Unit: -	Data Type: BOOL	Access Type: Read/Write

6.6.12.8 Feedforward Controller (Menu Index 5.10.6)

P 5.10.6.1 Feedforward Factor

Description: Set the PID feedforward factor. The factor sends a constant fraction of the reference signal to bypass the PID control. The feedforward factor provides less overshoot and higher dynamics when the reference is changed.

Default Value: 0	Parameter Type: Range (0 — 10000)	Parameter Number: 6063
Unit: -	Data Type: REAL	Access Type: Read/Write

P 5.10.6.2 Adv. Feedforward Maximum

Description: Set the advanced feedforward scaling value that corresponds to the maximum value for its selected reference source.

Default Value: 10	Parameter Type: Range (-1000000 — 1000000)	Parameter Number: 6011
Unit: -	Data Type: REAL	Access Type: Read/Write

P 5.10.6.3 Adv. Feedforward Minimum

Description: Set the advanced feedforward scaling value that corresponds to the minimum value for its selected reference source.

Default Value: 0	Parameter Type: Range (-1000000 — 1000000)	Parameter Number: 6012
Unit: -	Data Type: REAL	Access Type: Read/Write

P 5.10.6.4 Adv. Feedforward Ref. Mode

Description: Select the reference source for the advanced feedforward controller.

Default Value: 0 [None]	Parameter Type: Selection	Parameter Number: 6019
Unit: -	Data Type: UINT	Access Type: Read/Write

The following are the selections for the parameter.

Selection Number	Selection Name	Selection Description
0	None	No source selected equals a 0 value.
1	Reference 1 input	Use the reference from I/O reference 1.

Selection Number	Selection Name	Selection Description
2	Reference 2 input	Use the reference from I/O reference 2.
3	Analog Input Reference 1+2	Use the sum of values from I/O source 1 and 2 as reference source.
4	Fieldbus Reference	Use the value from the fieldbus as reference source.

P 5.10.6.5 Adv. Feedforward AI 1 Ref.

Description: Select the input for the reference number 1 of the advanced feedforward controller.

Default Value: 0	Parameter Type: Range (0 — 29999)	Parameter Number: 6023
Unit: -	Data Type: UINT	Access Type: Read/Write

P 5.10.6.6 Adv. Feedforward AI 2 Ref.

Description: Set the input for the reference number 2 of the advanced feedforward controller.

Default Value: 0	Parameter Type: Range (0 — 29999)	Parameter Number: 6024
Unit: -	Data Type: UINT	Access Type: Read/Write

P 5.10.6.7 Adv. Feedforward Inverted

Description: Inverts the reaction of the advanced feedforward controller.

Default Value: 0	Parameter Type: Range (0 — 1)	Parameter Number: 6073
Unit: -	Data Type: BOOL	Access Type: Read/Write

6.6.12.9 Additional Information on Feedforward Controller

These parameters allow the setting of feedforward controller that improves the response to setpoint settings.

P 5.10.6.1 Feedforward Factor

Feedforward is activated when this parameter is set to a value higher than 0. Enter the value in percentage. The factor sends a constant fraction of the reference signal to bypass the PID control. When the feedforward factor is activated, the process control provides less overshoot and improves the control performance (better step response) when the setpoint changes.

6.6.12.10 Auto Tuning (Menu Index 5.10.7)

P 5.10.7.1 Process Controller Auto Tuning

Description: Enables the auto tuning procedure of the process controller. Requires start signal and returns to false after completion.

Default Value: NA	Parameter Type: Range (0 — 1)	Parameter Number: 6901
Unit: -	Data Type: BOOL	Access Type: Read/Write

P 5.10.7.2 Auto Tuning Reference

Description: Set the reference point where the auto tuning is executed. Values are entered in process units.

Default Value: 0	Parameter Type: Range (-1000000 — 1000000)	Parameter Number: 6902
Unit: CustomProcessUnit	Data Type: REAL	Access Type: Read/Write

6.6.13 Inching (Menu Index 5.11)

P 5.11.1 Inching Mode

Description: Select the inching mode. Inching is used for operating the motor for periods with a specific inching reference.

Default Value: 1 [Jogging Mode]	Parameter Type: Selection	Parameter Number: 1081
Unit: -	Data Type: UINT	Access Type: Read/Write

The following are the selections for the parameter.

Selection Number	Selection Name	Selection Description
0	Slow Down Mode	Reduce speed to inching speed. If inching is activated in this mode motor speed will be limited to inching reference in same direction as the reference.
1	Jogging Mode	Jogging will start drive and run at defined inching speed. Jogging will be ignored if drive is already running or if stop or coast is activated.
2	Override Mode	Override mode, will run the override the reference with the reference defined as inching speed.

P 5.11.2 Enable Inching Input

Description: Select a terminal to enable inching.

Default Value:	Parameter Type: Selection	Parameter Number: 1080
Unit: -	Data Type: UINT	Access Type: Read/Write

P 5.11.3 Inching Ramp Time

Description: Set the ramp time for inching.

Default Value: 10	Parameter Type: Range (0.01 — 3600)	Parameter Number: 1083
Unit: s	Data Type: REAL	Access Type: Read/Write

P 5.11.4 Inching Reference 1

Description: Set reference 1 for inching.

Default Value: 15	Parameter Type: Range (-1000 — 1000)	Parameter Number: 1082
Unit: Hz	Data Type: REAL	Access Type: Read/Write

P 5.11.5 Inching Activate Input 1

Description: Select the terminal to inching with reference 1. Enable inching input must be active.

Default Value:	Parameter Type: Selection	Parameter Number: 1084
Unit: -	Data Type: UINT	Access Type: Read/Write

P 5.11.6 Inching Reference 2

Description: Set reference 2 for inching.

Default Value: -15	Parameter Type: Range (-1000 — 1000)	Parameter Number: 1085
Unit: Hz	Data Type: REAL	Access Type: Read/Write

P 5.11.7 Inching Activate Input 2

Description: Select the terminal to inching with reference 2. Enable inching input must be active.

Default Value:	Parameter Type: Selection	Parameter Number: 1086
Unit: -	Data Type: UINT	Access Type: Read/Write

P 5.11.8 Inching Active Output

Description: Select the output terminal or status bit indicating that inching is active.

Default Value:	Parameter Type: Selection	Parameter Number: 1087
Unit: -	Data Type: UINT	Access Type: Read/Write

6.6.14 Mechanical Brake Control (Menu Index 5.12)

6.6.14.1 Mechanical Brake Control Overview

The feature controls opening and closing of the mechanical brake and ensures the smooth transition of load between drive and mechanical brake. The mechanical brake holds the load when the drive is not running. The mechanical brake can be closed or released by controlling the torque, speed, and position. The feature supports the following load types:

- **Unidirectional load:** Typically used in scenarios when the load moves in the same direction such as in conveyors, winches, crane applications.
- **Bidirectional load:** Typically used in scenarios when the direction of the load is not known during startup, such as in elevator applications.

The mechanical brake control supports the following functions:

- 2 channels for mechanical braking feedback to offer further protection against unintended behavior resulting from broken cable.
- Monitoring of mechanical braking feedback throughout the complete cycle. Monitoring helps to protect the mechanical brake, especially if more drives are connected to the same shaft.
- No ramp-up until feedback confirms that mechanical brake is open.
- Improved load control at stop. If the value of the delay is too low, a warning is issued and the torque is not allowed to ramp down.
- The transition when motor takes over the load from the brake can be configured. Parameter **Release Bandwidth** can be increased to minimize the movement.

To achieve smooth transition, change the setting from speed control to position control during the changeover.

Starting with mechanical brake

- The motor must be primed by gradually applying a holding torque against the brake so that the torque step is minimized when the brake is released.
- When the configured torque is applied and priming time has passed, the brake is released. The torque and priming time is set via parameters **5.12.2.2 Brake Priming Torque** and **5.12.2.4 Brake Priming Time**. After priming, the brake is released.
- There is a physical delay between the electrical release of the brake and the physical release of the brake. This is referred to as brake release time and is set via the parameter **5.12.2.6 Brake Release Time**. When this happens, the load is shifted from the mechanical brake to the motor instantaneously.

Stopping with mechanical brake

- When stopping, the mechanical brake control monitors the motor speed and ramps down to 0 speed to close the brake.
- When closing speed is reached, the brake is activated, and the motor is held at 0 speed while the brake physically closes.
- When the brake is closed, torque is ramped down to 0, gradually shifting the load from motor to brake.

The following images represent the different functions of Mechanical Brake Control.

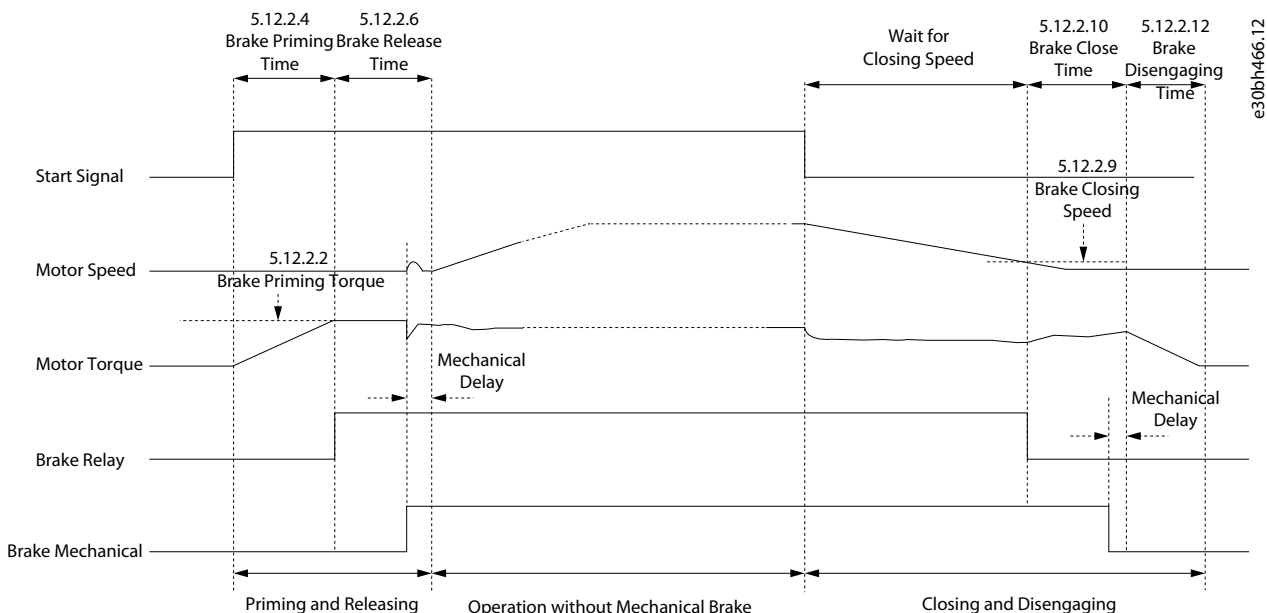

Figure 73: Mechanical Brake Control without Hovering

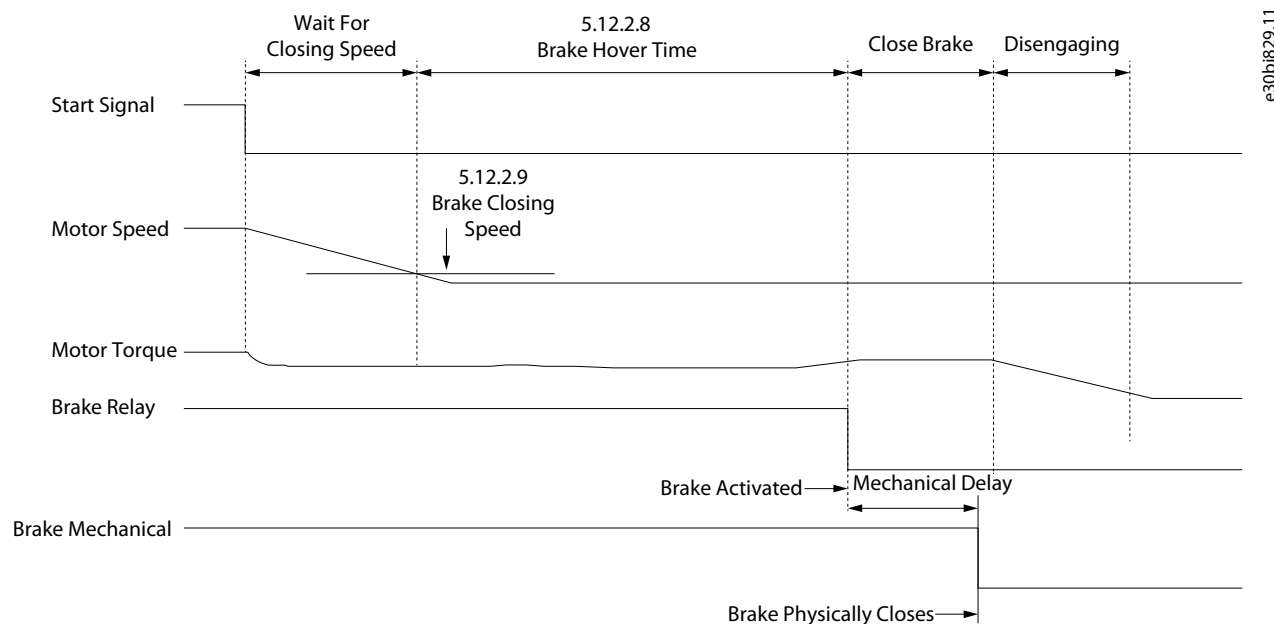

Figure 74: Mechanical Brake Control with Hovering

The following features are part of mechanical brake control:

- **Control:** Control brake via digital output and relay.
- **Optimization:** Automatically adapts to motor construction and control principle.
- **Feedback:** Supports digital brake feedback for open and closed loop, which provides faster control and monitoring.
- User configuration of mechanical brake control via parameters.
 - Digital inputs for brake feedback
 - Timeouts for release and close when using brake feedback
 - Digital output/relay for the mechanical brake
 - Timing and direction of applied torque for engaging or disengaging the mechanical brake
 - Mechanical brake release and close time
 - Hover delay
 - Brake close speed
 - Priming timeout



Note: Mechanical Brake Control requires operation in FVC+ in closed loop.

6.6.14.2 Mechanical Brake Control Status (Menu Index 5.12.1)

P 5.12.1.1 Mechanical Brake Status Word

Description: Shows the mechanical brake status word.

Default Value: NA	Parameter Type: Range (0 — 65535)	Parameter Number: 3016
Unit: -	Data Type: WORD	Access Type: Read Only

P 5.12.1.2 Mechanical Brake State

Description: Shows the state of the mechanical brake controller.

Default Value: NA	Parameter Type: Range (0 — 32767)	Parameter Number: 3017
Unit: -	Data Type: INT	Access Type: Read Only

P 5.12.1.3 Brake Release Time Detected

Description: Shows the time from brake release until load change is detected, where motor takes over the load from mechanical brake.

Default Value: NA	Parameter Type: Range (0 — 10000)	Parameter Number: 3041
Unit: s	Data Type: REAL	Access Type: Read Only

6.6.14.3 Mechanical Brake Control Status Word Descriptions

P 5.12.1.1 Mechanical Brake Status Word

Table 36: Status Word Description

Bit Number	Bit Name	Description
0	Enabled	Mechanical brake is enabled by a parameter.
1	Start	A start signal is provided to mechanical brake control.
2	Brake open feedback signal	Brake feedback is enabled and brake open is active.
3	Brake close feedback	Brake feedback is enabled and brake closed is active.
4–10	N/A	
11	Priming	The required release torque could not be generated.
12	Brake release timeout	Feedback is enabled but brake open feedback was not provided during brake release time.
13	Brake close timeout	Feedback is enabled but brake close feedback was not provided during brake close time.
14	BrakeCtrl active	Brake control is either in progress of opening or closing brake.
15	Brake open	Brake control has activated digital output.

6.6.14.4 Brake Settings (Menu Index 5.12.2)

P 5.12.2.1 Brake Output

Description: Select the output terminal for controlling the mechanical brake.

Default Value:	Parameter Type: Selection	Parameter Number: 3007
Unit: -	Data Type: UINT	Access Type: Read/Write

P 5.12.2.2 Brake Priming Torque

Description: Set the torque to be build up against the mechanical brake during priming before releasing the brake.

Default Value: 100	Parameter Type: Range (0 — 200)	Parameter Number: 3012
Unit: %	Data Type: REAL	Access Type: Read/Write

P 5.12.2.3 Brake Priming Direction

Description: Select the direction of the applied torque during priming before releasing the brake.

Default Value: 0 [Clockwise]	Parameter Type: Selection	Parameter Number: 3001
Unit: -	Data Type: UINT	Access Type: Read/Write

The following are the selections for the parameter.

Selection Number	Selection Name	Selection Description
0	Clockwise	Holding torque is applied in clockwise direction prior to opening the brake.
1	Counter clockwise	Holding torque is applied in counter clockwise direction prior to opening the brake.
2	Reference Direction	Holding torque is applied in same direction as the reference prior to opening the brake.

P 5.12.2.4 Brake Priming Time

Description: Set the priming time duration.

Default Value: 0.2	Parameter Type: Range (0 — 5)	Parameter Number: 3000
Unit: s	Data Type: REAL	Access Type: Read/Write

P 5.12.2.5 Brake Priming Timeout

Description: Set the time after which a warning will be generated if priming cannot be finalized.

Default Value: 5	Parameter Type: Range (2 — 10)	Parameter Number: 3006
Unit: s	Data Type: REAL	Access Type: Read/Write

P 5.12.2.6 Brake Release Time

Description: Set the time it takes for the mechanical brake to open and to release the load.

Default Value: 0.5	Parameter Type: Range (0.1 — 30)	Parameter Number: 3003
Unit: s	Data Type: REAL	Access Type: Read/Write

P 5.12.2.7 Brake Open Input

Description: Select the input terminal for an open indication signal from the mechanical brake.

Default Value:	Parameter Type: Selection	Parameter Number: 3010
Unit: -	Data Type: UINT	Access Type: Read/Write

P 5.12.2.8 Brake Hover Time

Description: Set the hover time. Hover time is the duration where the drive holds the load before the mechanical brake closes to allow an instant restart.

Default Value: 0	Parameter Type: Range (0 — 60)	Parameter Number: 3013
Unit: s	Data Type: REAL	Access Type: Read/Write

P 5.12.2.9 Brake Closing Speed

Description: Set the speed at which the brake gets active (control terminal goes low).

Default Value: 5	Parameter Type: Range (0 — 25)	Parameter Number: 3002
Unit: Hz	Data Type: REAL	Access Type: Read/Write

P 5.12.2.10 Brake Close Time

Description: Set the time it takes for the mechanical brake to close and to hold the load.

Default Value: 0.5	Parameter Type: Range (0.1 — 30)	Parameter Number: 3004
Unit: s	Data Type: REAL	Access Type: Read/Write

P 5.12.2.11 Brake Closed Input

Description: Select the input terminal for a closed signal from the mechanical brake.

Default Value:	Parameter Type: Selection	Parameter Number: 3011
Unit: -	Data Type: UINT	Access Type: Read/Write

P 5.12.2.12 Brake Disengaging Time

Description: Set the duration from the brake is closed to the holding torque is released.

Default Value: 0.2	Parameter Type: Range (0 — 5)	Parameter Number: 3005
Unit: s	Data Type: REAL	Access Type: Read/Write

P 5.12.2.13 Brake Release Bandwidth

Description: Set the release control bandwidth.

Default Value: 100	Parameter Type: Range (0 — 10000)	Parameter Number: 3015
Unit: %	Data Type: REAL	Access Type: Read/Write

P 5.12.2.15 Brake Close Immediately On Fault

Description: Enables immediate brake closure in case of a fault. Some faults will ramp to zero - if not set brake will wait for speed to be low enough.

Default Value: 1 [Enabled]	Parameter Type: Selection	Parameter Number: 3040
Unit: -	Data Type: BOOL	Access Type: Read/Write

The following are the selections for the parameter.

Selection Number	Selection Name	Selection Description
0	Disabled	Disables the function.
1	Enabled	Enables the function.

P 5.12.2.20 Brake Feedback Error Time

Description: Set the monitoring time for the brake feedback error. The error is triggered if brake open or close feedback(s) differ from the command signal for the set time. The monitoring is started when the brake open or close command is sent or the feedback signal(s) change status.

Default Value: 0	Parameter Type: Range (0 — 30)	Parameter Number: 3043
Unit: s	Data Type: REAL	Access Type: Read/Write

6.6.14.5 Additional Information on Brake Settings

P 5.12.2.1 Brake Output

0 Indicates that mechanical brake is disabled. Use the value 10105 to set a digital output where 1 refers to the control board, 01 refers to the option, and 05 refers to the terminal number.

Additional selections appear based on the hardware of the options connected to the drive and the available fieldbuses.

P 5.12.2.2 Brake Priming Torque

The value is set as percent of nominal torque. The value defines the torque applied against the closed mechanical brake before release. The torque/load on a crane is positive and is 10– 160%. To obtain the best starting point, set the parameter to approximately 70%. The torque/load on a lift can be both positive and negative and between -160% and +160%. To obtain the best starting point, set the parameter to 0%. The higher the torque error, the more movement during load takeover.

P 5.12.2.4 Brake Priming Time

The value in the parameter defines the duration of the torque ramp up in clockwise direction.

P 5.12.2.6 Brake Release Time

The value in the parameter defines the time taken for the mechanical brake to open. The configuration in the parameter acts as a timeout when brake feedback is activated.

P 5.12.2.8 Brake Hover Time

Defines the time at 0 speed. The value in the parameter defines the time interval from the moment when the motor is stopped until the brake closes. To adjust transition of the load to the mechanical braking, set both Brake Close Time and Hover Time parameters. This parameter is a part of the stop function.

P 5.12.2.10 Brake Close Time

Defines the delay from electrical closing of brake to when the brake physically closes. When closing, the load is transferred from motor to mechanical brake during disengaging. Enter the brake close time of the coast after ramp-down time. The shaft is held at 0 speed with full holding torque. Ensure that the mechanical braking has locked the load before the motor enters coast mode. To adjust transition of the load to the mechanical braking, set parameters **5.12.2.10 Brake Close Time** and **5.12.2.8 Brake Hover Time**. Setting of brake delay parameters does not affect the torque. The drive does not register that mechanical braking is holding the load. After setting parameter **5.12.2.10 Brake Close Time**, the torque drops to 0 after a few minutes. The sudden torque change leads to movement and noise.

P 5.12.2.12 Brake Disengaging Time

The value configured in this parameter defines the torque ramp down time to gradually transition the load from the motor to the brake. After the mechanical brake is closed, the motor still provides a holding torque. During disengage, holding torque is ramped to zero, gradually transferring load to mechanical brake.

6.6.15 Additional Status Outputs (Menu Index 5.26)

6.6.15.1 General Digital Outputs (Menu Index 5.26.1)

P 5.26.1.1 Ready Output

Description: Select an output to indicate that the unit is in ready mode.

Default Value:	Parameter Type: Selection	Parameter Number: 205
Unit: -	Data Type: UINT	Access Type: Read/Write

P 5.26.1.2 Run Output

Description: Select an output to indicate that the unit is in run mode.

Default Value:	Parameter Type: Selection	Parameter Number: 206
Unit: -	Data Type: UINT	Access Type: Read/Write

P 5.26.1.3 On Reference Output

Description: Select an output to indicate that the unit is on reference.

Default Value:	Parameter Type: Selection	Parameter Number: 207
Unit: -	Data Type: UINT	Access Type: Read/Write

P 5.26.1.4 Fault Event Output

Description: Select an output to indicate that a fault has occurred.

Default Value:	Parameter Type: Selection	Parameter Number: 208
Unit: -	Data Type: UINT	Access Type: Read/Write

P 5.26.1.5 Warning Event Output

Description: Select an output to indicate that a warning has occurred.

Default Value:	Parameter Type: Selection	Parameter Number: 209
Unit: -	Data Type: UINT	Access Type: Read/Write

P 5.26.1.26 Motor Disconnected Output

Description: Select an output to indicate that the motor is disconnected. Motor check must be enabled in disconnected motor response.

Default Value:	Parameter Type: Selection	Parameter Number: 216
Unit: -	Data Type: UINT	Access Type: Read/Write

6.6.16 Fieldbus Process Data (Menu Index 5.27)

6.6.16.1 Fieldbus Process Data Status (Menu Index 5.27.1)

P 5.27.1.42 Fieldbus Control Word

Description: Shows the profile specific fieldbus control word.

Default Value: NA	Parameter Type: Range (* — *)	Parameter Number: 1335
Unit: -	Data Type: WORD	Access Type: Read/Write

P 5.27.1.43 Fieldbus Speed Reference 1

Description: Shows the fieldbus speed reference.

Default Value: NA	Parameter Type: Range (-32768 — 32767)	Parameter Number: 1339
Unit: -	Data Type: INT	Access Type: Read/Write

P 5.27.1.44 Fieldbus Torque Reference

Description: Shows the fieldbus torque reference.

Default Value: NA	Parameter Type: Range (-32768 — 32767)	Parameter Number: 1343
Unit: -	Data Type: INT	Access Type: Read/Write

P 5.27.1.50 Fieldbus Status Word

Description: Shows the profile specific fieldbus status word.

Default Value: NA	Parameter Type: Range (0 — 65535)	Parameter Number: 1307
Unit: -	Data Type: WORD	Access Type: Read Only

P 5.27.1.51 Actual Motor Speed

Description: Shows the actual motor speed.

Default Value: NA	Parameter Type: Range (-32768 — 32767)	Parameter Number: 1308
Unit: -	Data Type: INT	Access Type: Read Only

P 5.27.1.54 Fieldbus Speed Reference

Description: Shows the fieldbus speed reference.

Default Value: NA	Parameter Type: Range (-1000 — 1000)	Parameter Number: 1345
Unit: Hz	Data Type: REAL	Access Type: Read/Write

P 5.27.1.73 Fieldbus Torque Main Actual Value

Description: Shows the torque applied by the motor.

Default Value: NA	Parameter Type: Range (-32768 — 32767)	Parameter Number: 1346
Unit: -	Data Type: INT	Access Type: Read Only

P 5.27.1.89 Fieldbus Control Word 2

Description: Shows the fieldbus control word 2.

Default Value: NA	Parameter Type: Range (* — *)	Parameter Number: 1347
Unit: -	Data Type: WORD	Access Type: Read/Write

P 5.27.1.90 Fieldbus Status Word 2

Description: Shows the profile specific fieldbus status word 2.

Default Value: NA	Parameter Type: Range (0 — 65535)	Parameter Number: 1344
Unit: -	Data Type: WORD	Access Type: Read Only

P 5.27.1.100 Fieldbus Process Reference

Description: Shows the fieldbus process reference used in the process controller.

Default Value: NA	Parameter Type: Range (-32768 — 32767)	Parameter Number: 6046
Unit: -	Data Type: INT	Access Type: Read/Write

6.6.16.2 Additional Information on Fieldbus Process Data Status

P 5.27.1.42 Fieldbus Control Word

The fieldbus control word is either the PROFIdrive control word described in [2.12.2 Control Word \(CTW\) in PROFIdrive Standard Telegram 1](#) or the iC Speed control word described in [2.13.2 Control Word \(CTW\) in iC Speed Profile](#). The fieldbus profile is selected with parameter [10.3.1.2 Fieldbus Profile](#).

P 5.27.1.50 Fieldbus Status Word

The fieldbus status word is either the PROFIdrive status word described in [2.12.3 Status Word \(STW\) in PROFIdrive Standard Telegram 1](#) or the iC Speed status word described in [2.13.3 Status Word \(STW\) in iC Speed Profile](#). The fieldbus profile is selected with parameter [10.3.1.2 Fieldbus Profile](#).

P 5.27.1.89 Fieldbus Control Word 2

The fieldbus control and status words are freely configurable, and specific features can be assigned to the bits.

P 5.27.1.90 Fieldbus Status Word 2

The fieldbus control and status words are freely configurable, and specific features can be assigned to the bits.

6.6.17 Auxiliary Device Control (Menu Index 5.33)

P 5.33.1 Motor and Cabinet Heater Ctrl. Output

Description: Select an output to control the motor and cabinet heaters.

Default Value:	Parameter Type: Selection	Parameter Number: 220
Unit: -	Data Type: UINT	Access Type: Read/Write

P 5.33.2 Motor Fan Ctrl. Output

Description: Select an output to control the motor fan.

Default Value:	Parameter Type: Selection	Parameter Number: 221
Unit: -	Data Type: UINT	Access Type: Read/Write

P 5.33.3 Cabinet Cooling Fan Ctrl. Output

Description: Select an output to control the cabinet cooling fan.

Default Value:	Parameter Type: Selection	Parameter Number: 222
Unit: -	Data Type: UINT	Access Type: Read/Write

6.7 Maintenance & Service (Menu Index 6)

6.7.1 Maintenance & Service Overview

This parameter group contains parameters exclusively related to status, events, and backup and restore.

6.7.2 Status (Menu Index 6.1)

6.7.2.1 Grid Status (Menu Index 1.1)

P 1.1.1 Grid Frequency

Description: Shows the actual grid frequency.

Default Value: NA	Parameter Type: Range (* — *)	Parameter Number: 9041
Unit: Hz	Data Type: REAL	Access Type: Read Only

P 1.1.2 Line-To-Line Voltage (RMS)

Description: Shows the average line-to-line voltage (RMS).

Default Value: NA	Parameter Type: Range (0 — *)	Parameter Number: 9040
Unit: V	Data Type: REAL	Access Type: Read Only

P 1.1.3 L1-L2 Line Voltage (RMS)

Description: Shows the L1-L2 line voltage (RMS).

Default Value: NA	Parameter Type: Range (0 — *)	Parameter Number: 9048
Unit: V	Data Type: REAL	Access Type: Read Only

P 1.1.4 L2-L3 Line Voltage (RMS)

Description: Shows the L2-L3 line voltage (RMS).

Default Value: NA	Parameter Type: Range (0 — *)	Parameter Number: 9049
Unit: V	Data Type: REAL	Access Type: Read Only

P 1.1.5 L3-L1 Line Voltage (RMS)

Description: Shows the L3-L1 line voltage (RMS).

Default Value: NA	Parameter Type: Range (0 — *)	Parameter Number: 9050
Unit: V	Data Type: REAL	Access Type: Read Only

P 1.1.6 Grid Voltage Imbalance

Description: Shows the grid voltage imbalance in %. A value greater than 3% may indicate grid problems.

Default Value: NA	Parameter Type: Range (0 — 100)	Parameter Number: 9047
Unit: %	Data Type: REAL	Access Type: Read Only

P 1.1.7 Total Harmonic Distortion (THDv)

Description: Shows the total harmonic distortion of the grid voltage (THDv) in %.

Default Value: NA	Parameter Type: Range (0 — 100)	Parameter Number: 9046
Unit: %	Data Type: REAL	Access Type: Read Only

P 1.1.12 Grid Active Power

Description: Shows the active power at the point of grid connection.

Default Value: NA	Parameter Type: Range (* — *)	Parameter Number: 9064
Unit: kW	Data Type: REAL	Access Type: Read Only

6.7.2.2 Power Conversion & DC Link Status (Menu Index 2.1)

P 2.1.1 Unit Nominal Voltage

Description: Shows the nominal voltage setting as a result of the setting of parameter "2.2.1.1 Unit Voltage Class".

Default Value: 400	Parameter Type: Range (0 — *)	Parameter Number: 2830
Unit: V	Data Type: REAL	Access Type: Read Only

P 2.1.2 Unit Nominal Current

Description: Shows the nominal current of the unit.

Default Value: 23	Parameter Type: Range (0 — *)	Parameter Number: 2831
Unit: A	Data Type: REAL	Access Type: Read Only

P 2.1.3 DC-link Voltage

Description: Shows the actual DC-link voltage.

Default Value: NA	Parameter Type: Range (0 — *)	Parameter Number: 9044
Unit: V	Data Type: REAL	Access Type: Read Only

P 2.1.7 DC-link Power

Description: Shows the actual DC-link power.

Default Value: NA	Parameter Type: Range (* — *)	Parameter Number: 5117
Unit: kW	Data Type: REAL	Access Type: Read Only

P 2.1.10 U-phase RMS Current

Description: Shows the U-phase RMS current.

Default Value: NA	Parameter Type: Range (0 — *)	Parameter Number: 9020
Unit: A	Data Type: REAL	Access Type: Read Only

P 2.1.11 V-phase RMS Current

Description: Shows the V-phase RMS current.

Default Value: NA	Parameter Type: Range (0 — *)	Parameter Number: 9021
Unit: A	Data Type: REAL	Access Type: Read Only

P 2.1.12 W-phase RMS Current

Description: Shows the W-phase RMS current.

Default Value: NA	Parameter Type: Range (0 — *)	Parameter Number: 9022
Unit: A	Data Type: REAL	Access Type: Read Only

P 2.1.14 Actual Relative Output Current Limit

Description: Shows the actual output current limit relative to the nominal motor current.

Default Value: NA	Parameter Type: Range (0 — 300)	Parameter Number: 2700
Unit: %	Data Type: REAL	Access Type: Read Only

P 2.1.15 Heat Sink Temperature

Description: Shows the temperature of the power unit heat sink.

Default Value: NA	Parameter Type: Range (-50 — 200)	Parameter Number: 2950
Unit: °C	Data Type: REAL	Access Type: Read Only

P 2.1.16 Main Fan Speed

Description: Shows the speed of the main cooling fan.

Default Value: NA	Parameter Type: Range (0 — 32767)	Parameter Number: 2931
Unit: rpm	Data Type: INT	Access Type: Read Only

P 2.1.17 Internal Fan Speed

Description: Shows the speed of the internal cooling fan.

Default Value: NA	Parameter Type: Range (0 — 32767)	Parameter Number: 2926
Unit: rpm	Data Type: INT	Access Type: Read Only

P 2.1.19 Heat Sink Temperature Output

Description: Select the output indicating if the heat sink temperature is within range.

Default Value:	Parameter Type: Selection	Parameter Number: 2312
Unit: -	Data Type: UINT	Access Type: Read/Write

P 2.1.20 Drive DC-link Voltage Output

Description: Select the output indicating if the DC-link voltage is within range.

Default Value:	Parameter Type: Selection	Parameter Number: 2311
Unit: -	Data Type: UINT	Access Type: Read/Write

6.7.2.3 Filters & Brake Chopper Status (Menu Index 3.1)

P 3.1.1 Brake Power

Description: Shows the power dissipated in the brake resistor.

Default Value: NA	Parameter Type: Range (0.00 — *)	Parameter Number: 2933
Unit: kW	Data Type: REAL	Access Type: Read Only

P 3.1.2 Average Brake Power

Description: Shows the average power dissipated in the brake resistor, calculated over 120 s.

Default Value: NA	Parameter Type: Range (0.00 — *)	Parameter Number: 2934
Unit: kW	Data Type: REAL	Access Type: Read Only

P 3.1.3 AHF Capacitor Connected

Description: Shows if the advanced harmonic filter (AHF) capacitor is connected.

Default Value: NA	Parameter Type: Range (0 — 1)	Parameter Number: 5410
Unit: -	Data Type: BOOL	Access Type: Read Only

6.7.2.4 Motor Status (Menu Index 4.1)

P 4.1.1 Motor Current

Description: Shows the actual motor current.

Default Value: NA	Parameter Type: Range (0 — *)	Parameter Number: 9000
Unit: A	Data Type: REAL	Access Type: Read Only

P 4.1.2 Relative Motor Current

Description: Shows the actual motor current in % of the nominal motor current.

Default Value: NA	Parameter Type: Range (0 — 200)	Parameter Number: 9001
Unit: %	Data Type: REAL	Access Type: Read Only

P 4.1.3 U-phase RMS Current

Description: Shows the U-phase RMS current.

Default Value: NA	Parameter Type: Range (0 — *)	Parameter Number: 9020
Unit: A	Data Type: REAL	Access Type: Read Only

P 4.1.4 V-phase RMS Current

Description: Shows the V-phase RMS current.

Default Value: NA	Parameter Type: Range (0 — *)	Parameter Number: 9021
Unit: A	Data Type: REAL	Access Type: Read Only

P 4.1.5 W-phase RMS Current

Description: Shows the W-phase RMS current.

Default Value: NA	Parameter Type: Range (0 — *)	Parameter Number: 9022
Unit: A	Data Type: REAL	Access Type: Read Only

P 4.1.6 Motor Voltage

Description: Shows the actual motor voltage.

Default Value: NA	Parameter Type: Range (0 — *)	Parameter Number: 9005
Unit: V	Data Type: REAL	Access Type: Read Only

P 4.1.7 Relative Motor Voltage

Description: Shows the actual motor voltage in % of the nominal motor voltage.

Default Value: NA	Parameter Type: Range (0 — 200)	Parameter Number: 9006
Unit: %	Data Type: REAL	Access Type: Read Only

P 4.1.11 Motor Torque

Description: Shows the actual motor torque.

Default Value: NA	Parameter Type: Range (-10000000 — 10000000)	Parameter Number: 9009
Unit: Nm	Data Type: REAL	Access Type: Read Only

P 4.1.12 Relative Motor Torque

Description: Shows the motor torque in % of the nominal motor torque.

Default Value: NA	Parameter Type: Range (* — *)	Parameter Number: 1708
Unit: %	Data Type: REAL	Access Type: Read Only

P 4.1.13 Motor Shaft Power

Description: Shows the actual power at the motor shaft.

Default Value: NA	Parameter Type: Range (* — *)	Parameter Number: 9008
Unit: kW	Data Type: REAL	Access Type: Read Only

P 4.1.14 Relative Motor Shaft Power

Description: Shows the actual motor shaft power in % of the nominal motor shaft power.

Default Value: NA	Parameter Type: Range (-300 — 300)	Parameter Number: 1707
Unit: %	Data Type: REAL	Access Type: Read Only

P 4.1.15 Motor Electrical Power

Description: Shows the actual motor power.

Default Value: NA	Parameter Type: Range (* — *)	Parameter Number: 9043
Unit: kW	Data Type: REAL	Access Type: Read Only

P 4.1.16 Motor Thermal Load (ETR)

Description: Shows the estimated thermal load of the motor calculated by the ETR function.

Default Value: NA	Parameter Type: Range (0 — 100)	Parameter Number: 2951
Unit: %	Data Type: REAL	Access Type: Read Only

P 4.1.17 Motor Current Output

Description: Select an output for the motor current signal. The scale of the signal is 0–100% of the nominal current.

Default Value:	Parameter Type: Selection	Parameter Number: 2302
Unit: -	Data Type: UINT	Access Type: Read/Write

P 4.1.18 Motor Voltage Output

Description: Select an output for the motor voltage signal. The scale of the signal is 0–100% of the nominal voltage.

Default Value:	Parameter Type: Selection	Parameter Number: 2303
Unit: -	Data Type: UINT	Access Type: Read/Write

P 4.1.19 Absolute Motor Torque Output

Description: Select an output for the motor torque signal. The scale of the signal is 0–100% of the absolute value of the nominal torque.

Default Value:	Parameter Type: Selection	Parameter Number: 2306
Unit: -	Data Type: UINT	Access Type: Read/Write

P 4.1.20 Extended Motor Torque Output

Description: Select an output for the motor torque signal. The scale of the signal is -200...200% of the nominal torque.

Default Value:	Parameter Type: Selection	Parameter Number: 2310
Unit: -	Data Type: UINT	Access Type: Read/Write

P 4.1.21 Absolute Motor Speed Output

Description: Select an output for the motor speed signal. The scale of the signal is 0–100% of the absolute value of the nominal speed.

Default Value:	Parameter Type: Selection	Parameter Number: 2301
Unit: -	Data Type: UINT	Access Type: Read/Write

P 4.1.22 Extended Motor Speed Output

Description: Select an output for the motor speed signal. The scale of the signal is -200...200% of the nominal speed.

Default Value:	Parameter Type: Selection	Parameter Number: 2309
Unit: -	Data Type: UINT	Access Type: Read/Write

P 4.1.23 Motor Power Output

Description: Select an output for the motor power signal. The scale of the signal is 0–100% of the nominal power.

Default Value:	Parameter Type: Selection	Parameter Number: 2305
Unit: -	Data Type: UINT	Access Type: Read/Write

P 4.1.24 AMA Progress

Description: Shows the progress of the Automatic Motor Adaptation (AMA).

Default Value: NA	Parameter Type: Range (0 — 100)	Parameter Number: 429
Unit: %	Data Type: REAL	Access Type: Read Only

P 4.1.26 Motor Temperature

Description: The analog temperature sensor has exceeded the configured value.

Default Value: NA	Parameter Type: Range (-300 — 300)	Parameter Number: 1630
Unit: °C	Data Type: REAL	Access Type: Read Only

P 4.1.28 Rs Measured

Description: When a Rs measurement has been stored for use after drive power recycle, the value is shown here; otherwise it is zero.

Default Value:	Parameter Type: Range (0 — 1000000)	Parameter Number: 433
Unit: Ω	Data Type: REAL	Access Type: Read/Write

6.7.2.5 Application Status (Menu Index 5.1)

P 5.1.1 Motor Ctrl. Status Word

Description: Shows the motor control status word.

Default Value: NA	Parameter Type: Range (* — *)	Parameter Number: 1714
Unit: -	Data Type: WORD	Access Type: Read Only

P 5.1.2 Motor Ctrl. Ready Status Word

Description: Shows the motor control ready status word. All status bits must be true before the drive is ready.

Default Value: NA	Parameter Type: Range (* — *)	Parameter Number: 1716
Unit: -	Data Type: WORD	Access Type: Read Only

P 5.1.3 Motor Regulator Status Word

Description: Shows the current state of the motor regulator status word. The status word indicates if a limit controller is active.

Default Value: NA	Parameter Type: Range (* — *)	Parameter Number: 1715
Unit: -	Data Type: WORD	Access Type: Read Only

P 5.1.5 Fault Status Word 1

Description: Shows the fault status word 1.

Default Value: -	Parameter Type:	Parameter Number: 6203
Unit:	Data Type: DWORD	Access Type: -

P 5.1.8 Warning Status Word 1

Description: Shows the warning status word 1.

Default Value: -	Parameter Type:	Parameter Number: 6205
Unit:	Data Type: DWORD	Access Type: -

P 5.1.13 Application Status Word

Description: Shows the application-specific status word.

Default Value: NA	Parameter Type: Range (0 — 65535)	Parameter Number: 1608
Unit: -	Data Type: WORD	Access Type: Read Only

6.7.2.6 Application Status Word Descriptions

P 5.1.1 Motor Ctrl. Status Word

Bit	Description
0	Ready
1	Run
2	Reverse
3	Fault
4	Reserved
5	At reference
6	Zero speed
7	Protection mode active

P 5.1.2 Motor Ctrl. Ready Status Word

Bit	Description
0	Run Enable high.
1	No fault active.
2	DC-link precharging done.
3	DC Voltage within limits.
4	Power manager initialized.
5	Brake test not running.
6	System software is not blocking start.
7	Grid voltage within limits.
8	Temperature within limits.

Bit	Description
9	Valid motor data.
10	Valid control configuration.

P 5.1.3 Motor Regulator Status Word

Bit	Description
0	Current limit control active (motoring side).
1	Current limit control active (generator side).
2	Torque limit control active (motoring side).
3	Torque limit control active (generator side).
4	Overvoltage control active.
5	Undervoltage control active.
6	Power limit control active (motoring side).
7	Power limit control active (generator side).
8	Speed limit control active.
9	AC-brake control active.

P 5.1.5 Fault Status Word 1

Bit	Description	Event number
0	Overcurrent	4384, 4373, 5170, 4368, 4369, 4375, 4377, 4380, 4097
1	Overvoltage	4164, 4162, 4144 4145
2	Undervoltage	4165, 4146
3	Unit temperature high	4117, 4118, 4119
4	Unit temperature low	4116
5	Control board overtemperature	4121, 4122, 4123, 4120
6	Input phase	4160, 4163
7	Output phase	4175, 4176
8	Ground fault	4379, 4352, 4353, 4354, 4355
9	Fan failure	4128, 4129, 4133, 4130
10	Fieldbus communication	5162, 4256, 4257, 4258, 4260, 4261, 4263, 4265, 4266, 4267, 4268, 4269, 4280, 4281, 4270, 4271, 4272, 4273, 4282, 4274, 4275, 4276, 4277, 4283, 4278, 4279
11	HMI connection	5141, 5142
12	Feedback connection	4418

Bit	Description	Event number
13	Thermistor input	5157
14	Auxiliary device (temperature)	4200, 4201, 4203, 4202
15	External temperature measurement	5132, 5133, 5134, 5135, 5136, 5137, 5158

P 5.1.8 Warning Status Word 1

Bit	Description	Event number
0	Overcurrent	4384, 4373, 5170, 4368, 4369, 4375, 4377, 4380, 4097
1	Overvoltage	4164, 4162, 4144 4145
2	Undervoltage	4165, 4146
3	Unit temperature high	4117, 4118, 4119
4	Unit temperature low	4116
5	Control board overtemperature	4121, 4122, 4123, 4120
6	Input phase	4160, 4163
7	Output phase	4175, 4176
8	Ground fault	4379, 4352, 4353, 4354, 4355
9	Fan failure	4128, 4129, 4133, 4130
10	Fieldbus communication	5162, 4256, 4257, 4258, 4260, 4261, 4263, 4265, 4266, 4267, 4268, 4269, 4280, 4281, 4270, 4271, 4272, 4273, 4282, 4274, 4275, 4276, 4277, 4283, 4278, 4279
11	HMI connection	5141, 5142
12	Feedback connection	4418
13	Thermistor input	5157
14	Auxiliary device (temperature)	4200, 4201, 4203, 4202
15	External temperature measurement	5132, 5133, 5134, 5135, 5136, 5137, 5158

P 5.1.13 Application Status Word

Bit	Bit = False	Bit = True
0	Reserved	Reserved
1	Inching not Active	Inching Active
2	Process Control not Active	Process Control Active
3	Reserved	Reserved
4	Reserved	Reserved
5	Reserved	Reserved

Bit	Bit = False	Bit = True
6	Reserved	Reserved
7	Reserved	Reserved
8	Reserved	Reserved
9	Reserved	Reserved
10	Reserved	Reserved
11	Reserved	Reserved
12	Reserved	Reserved
13	Normal Reference	Freeze Reference
14	Normal Reference	Reverse Reference
15	Speed Within Limits	Speed Limit Active

6.7.2.7 Measured Temp. Protection Status (Menu Index 5.2.3.1)

P 5.2.3.1.1 Protection 1 Temp.

Description: Shows the temperature measured for the temperature protection.

Default Value: NA	Parameter Type: Range (-300 — 300)	Parameter Number: 5200
Unit: °C	Data Type: REAL	Access Type: Read Only

P 5.2.3.1.2 Protection 2 Temp.

Description: Shows the temperature measured for the temperature protection.

Default Value: NA	Parameter Type: Range (-300 — 300)	Parameter Number: 5201
Unit: °C	Data Type: REAL	Access Type: Read Only

P 5.2.3.1.3 Protection 3 Temp.

Description: Shows the temperature measured for the temperature protection.

Default Value: NA	Parameter Type: Range (-300 — 300)	Parameter Number: 5202
Unit: °C	Data Type: REAL	Access Type: Read Only

P 5.2.3.1.4 Protection 4 Temp.

Description: Shows the temperature measured for the temperature protection.

Default Value: NA	Parameter Type: Range (-300 — 300)	Parameter Number: 5203
Unit: °C	Data Type: REAL	Access Type: Read Only

P 5.2.3.1.5 Protection 5 Temp.

Description: Shows the temperature measured for the temperature protection.

Default Value: NA	Parameter Type: Range (-300 — 300)	Parameter Number: 5204
Unit: °C	Data Type: REAL	Access Type: Read Only

P 5.2.3.1.6 Protection 6 Temp.

Description: Shows the temperature measured for the temperature protection.

Default Value: NA	Parameter Type: Range (-300 — 300)	Parameter Number: 5205
Unit: °C	Data Type: REAL	Access Type: Read Only

6.7.2.8 Load Status (Menu Index 5.3.1)

P 5.3.1.1 Inertia Estimation Status

Description: Shows the status of the inertia estimation routine. 0 = Inactive, 1 = In progress, 2 = Completed successfully, 3 = Completed unsuccessfully.

Default Value: NA	Parameter Type: Selection	Parameter Number: 666
Unit: -	Data Type: UINT	Access Type: Read Only

The following are the selections for the parameter.

Selection Number	Selection Name	Selection Description
0	Inactive	
1	In progress	
2	Completed successfully	
3	Completed unsuccessfully	

6.7.2.9 Control Places Status (Menu Index 5.5.1)

P 5.5.1.1 Active Control Place

Description: Shows the control place that controls the drive.

Default Value: NA	Parameter Type: Selection	Parameter Number: 113
Unit: -	Data Type: UINT	Access Type: Read Only

The following are the selections for the parameter.

Selection Number	Selection Name	Selection Description
0	PC control	The drive is controlled by a software tool.
1	Local control	The drive is controlled by a connected control panel.
2	Fieldbus control	The drive is controlled via a fieldbus.
3	I/O control	The drive is controlled via I/O.
4	Advanced control	The drive is controlled via a combination of I/O and fieldbus.

P 5.5.1.2 Local Control Active Output

Description: Select an output terminal indicating that the drive is in local control.

Default Value:	Parameter Type: Selection	Parameter Number: 5178
Unit: -	Data Type: UINT	Access Type: Read/Write

P 5.5.1.3 Fieldbus Control Active Output

Description: Select an output terminal indicating that the drive is in fieldbus control.

Default Value:	Parameter Type: Selection	Parameter Number: 5197
Unit: -	Data Type: UINT	Access Type: Read/Write

P 5.5.1.4 I/O Control Active Output

Description: Select an output terminal indicating that the drive is in I/O control.

Default Value:	Parameter Type: Selection	Parameter Number: 5177
Unit: -	Data Type: UINT	Access Type: Read/Write

P 5.5.1.5 Advanced Control Active Output

Description: Select an output terminal indicating that the drive is in advanced control.

Default Value:	Parameter Type: Selection	Parameter Number: 4727
Unit: -	Data Type: UINT	Access Type: Read/Write

6.7.2.10 Speed Control Status (Menu Index 5.8.1)

P 5.8.1.2 Motor Speed

Description: Shows the actual motor speed.

Default Value: NA	Parameter Type: Range (* — *)	Parameter Number: 9011
Unit: Hz	Data Type: REAL	Access Type: Read Only

P 5.8.1.3 Output Frequency

Description: Shows the output frequency.

Default Value: NA	Parameter Type: Range (* — *)	Parameter Number: 9015
Unit: Hz	Data Type: REAL	Access Type: Read Only

P 5.8.1.4 Feedback Speed

Description: Shows the feedback speed.

Default Value: NA	Parameter Type: Range (-10000 — 10000)	Parameter Number: 9007
Unit: rpm	Data Type: REAL	Access Type: Read Only

P 5.8.1.5 Feedback Electrical Angle

Description: Shows the feedback device angle in the electrical domain. Its value is needed for manually tuning the feedback angle offset.

Default Value: NA	Parameter Type: Range (0 — 360)	Parameter Number: 9016
Unit: °	Data Type: REAL	Access Type: Read Only

P 5.8.1.6 Speed Error

Description: Shows the difference between speed reference after ramp and motor speed.

Default Value: NA	Parameter Type: Range (* — *)	Parameter Number: 4023
Unit: Hz	Data Type: REAL	Access Type: Read Only

P 5.8.1.7 Speed Reference

Description: Shows the speed reference.

Default Value: NA	Parameter Type: Range (-2000 — 2000)	Parameter Number: 1718
Unit: Hz	Data Type: REAL	Access Type: Read/Write

P 5.8.1.8 Speed Reference Before Ramp

Description: Shows the value of speed reference before the ramp generator.

Default Value: NA	Parameter Type: Range (-2000 — 2000)	Parameter Number: 6049
Unit: Hz	Data Type: REAL	Access Type: Read Only

P 5.8.1.9 Speed Reference After Ramp

Description: Shows the value of the speed reference after the ramp generator.

Default Value: NA	Parameter Type: Range (* — *)	Parameter Number: 6150
Unit: Hz	Data Type: REAL	Access Type: Read Only

P 5.8.1.10 Final Speed Reference

Description: Shows the value of the speed reference before feeding it to the speed controller.

Default Value: NA	Parameter Type: Range (* — *)	Parameter Number: 6151
Unit: Hz	Data Type: REAL	Access Type: Read Only

P 5.8.1.11 Control Panel Speed Reference

Description: Shows the value of the speed reference given from the control panel.

Default Value: NA	Parameter Type: Range (* — *)	Parameter Number: 6153
Unit: Hz	Data Type: REAL	Access Type: Read/Write

P 5.8.1.12 Absolute Output Frequency Output

Description: Select an output terminal for the output frequency scaled between 0 Hz and positive speed limits in Hz.

Default Value:	Parameter Type: Selection	Parameter Number: 2300
Unit: -	Data Type: UINT	Access Type: Read/Write

P 5.8.1.13 Absolute Speed Reference Output

Description: Select an output terminal for the absolute speed reference, scaled between 0 and positive speed limit.

Default Value:	Parameter Type: Selection	Parameter Number: 2304
Unit: -	Data Type: UINT	Access Type: Read/Write

P 5.8.1.14 Output Frequency Output

Description: Select an output terminal for the output frequency scaled between minimum speed limit and positive speed limits in Hz.

Default Value:	Parameter Type: Selection	Parameter Number: 2308
Unit: -	Data Type: UINT	Access Type: Read/Write

P 5.8.1.16 Load Drooping Speed

Description: Shows the load drooping speed.

Default Value: NA	Parameter Type: Range (0 — 2000)	Parameter Number: 674
Unit: Hz	Data Type: REAL	Access Type: Read Only

6.7.2.11 Additional Information on Speed Control Status

P 5.8.1.12 Absolute Output Frequency Output

 **Note:** Selection lists with inputs and/or outputs consist of the name of the hardware option and the numbers of the terminals. For example, terminal number 13 of the Basic I/O is called Basic I/O T13 in the selection list.

P 5.8.1.13 Absolute Speed Reference Output

 **Note:** Selection lists with inputs and/or outputs consist of the name of the hardware option and the numbers of the terminals. For example, terminal number 13 of the Basic I/O is called Basic I/O T13 in the selection list.

P 5.8.1.13 Absolute Speed Reference Output

 **Note:** Selection lists with inputs and/or outputs consist of the name of the hardware option and the numbers of the terminals. For example, terminal number 13 of the Basic I/O is called Basic I/O T13 in the selection list.

6.7.2.12 Torque Control Status (Menu Index 5.9.1)

P 5.9.1.1 Motor Torque

Description: Shows the actual motor torque.

Default Value: NA	Parameter Type: Range (-10000000 — 10000000)	Parameter Number: 9009
Unit: Nm	Data Type: REAL	Access Type: Read Only

P 5.9.1.2 Relative Motor Torque

Description: Shows the motor torque in % of the nominal motor torque.

Default Value: NA	Parameter Type: Range (* — *)	Parameter Number: 1708
Unit: %	Data Type: REAL	Access Type: Read Only

P 5.9.1.3 Torque Limit Motoring

Description: Shows the torque limit in motoring mode in % of nominal motor torque.

Default Value: NA	Parameter Type: Range (0 — 500)	Parameter Number: 1812
Unit: %	Data Type: REAL	Access Type: Read/Write

P 5.9.1.4 Torque Limit Regenerative

Description: Shows the regenerative torque limit in % of nominal motor torque.

Default Value: NA	Parameter Type: Range (0 — 500)	Parameter Number: 1813
Unit: %	Data Type: REAL	Access Type: Read/Write

P 5.9.1.5 Local Torque Reference

Description: Shows the local torque reference set in the control panel.

Default Value: NA	Parameter Type: Range (-300 — 300)	Parameter Number: 6155
Unit: %	Data Type: REAL	Access Type: Read/Write

P 5.9.1.6 Torque Reference

Description: Shows the value of the current torque reference in the reference chain in % of nominal motor torque.

Default Value: NA	Parameter Type: Range (-300 — 300)	Parameter Number: 6152
Unit: %	Data Type: REAL	Access Type: Read/Write

P 5.9.1.7 Torque Reference Final

Description: Shows the value of the final torque reference given to the motor controller in % of nominal motor torque.

Default Value: NA	Parameter Type: Range (-300 — 300)	Parameter Number: 6154
Unit: %	Data Type: REAL	Access Type: Read Only

6.7.2.13 Process Control Status (Menu Index 5.10.1)

P 5.10.1.1 On Reference

Description: Shows if the controlled process is operating on the current reference.

Default Value: NA	Parameter Type: Range (0 — 1)	Parameter Number: 6074
Unit: -	Data Type: BOOL	Access Type: Read Only

P 5.10.1.2 Process Controller Output

Description: Shows the process controller's output as normalized value (in the range 0 to 1).

Default Value: NA	Parameter Type: Range (-1000000 — 1000000)	Parameter Number: 6075
Unit: -	Data Type: REAL	Access Type: Read Only

P 5.10.1.3 Setpoint Value

Description: Shows the actual value of the setpoint.

Default Value: NA	Parameter Type: Range (-1000000 — 1000000)	Parameter Number: 6092
Unit: -	Data Type: REAL	Access Type: Read Only

P 5.10.1.4 Feedback Value

Description: Shows the actual value of the feedback.

Default Value: NA	Parameter Type: Range (* — *)	Parameter Number: 6090
Unit: CustomProcessUnit	Data Type: REAL	Access Type: Read Only

P 5.10.1.5 Adv. Feedforward Value

Description: Shows the actual value of the advanced feedforward.

Default Value: NA	Parameter Type: Range (-1000000 — 1000000)	Parameter Number: 6086
Unit: -	Data Type: REAL	Access Type: Read Only

P 5.10.1.6 Feedback 1 Value

Description: Shows the actual value of feedback 1.

Default Value: NA	Parameter Type: Range (-1000000 — 1000000)	Parameter Number: 6080
Unit: -	Data Type: REAL	Access Type: Read Only

P 5.10.1.7 Feedback 2 Value

Description: Shows the actual value of feedback 2.

Default Value: NA	Parameter Type: Range (-1000000 — 1000000)	Parameter Number: 6085
Unit: CustomProcessUnit	Data Type: REAL	Access Type: Read Only

P 5.10.1.9 Control Panel Process Reference

Description: Shows the value of the process reference given from the control panel.

Default Value: NA	Parameter Type: Range (-1000000 — 1000000)	Parameter Number: 6094
Unit: CustomProcessUnit	Data Type: REAL	Access Type: Read/Write

P 5.10.1.10 Process Controller Enabled

Description: Enables the process controller.

Default Value: NA	Parameter Type: Range (0 — 1)	Parameter Number: 6053
Unit: -	Data Type: BOOL	Access Type: Read Only

6.7.2.14 Mechanical Brake Control Status (Menu Index 5.12.1)

P 5.12.1.1 Mechanical Brake Status Word

Description: Shows the mechanical brake status word.

Default Value: NA	Parameter Type: Range (0 — 65535)	Parameter Number: 3016
Unit: -	Data Type: WORD	Access Type: Read Only

P 5.12.1.2 Mechanical Brake State

Description: Shows the state of the mechanical brake controller.

Default Value: NA	Parameter Type: Range (0 — 32767)	Parameter Number: 3017
Unit: -	Data Type: INT	Access Type: Read Only

P 5.12.1.3 Brake Release Time Detected

Description: Shows the time from brake release until load change is detected, where motor takes over the load from mechanical brake.

Default Value: NA	Parameter Type: Range (0 — 10000)	Parameter Number: 3041
Unit: s	Data Type: REAL	Access Type: Read Only

6.7.2.15 Mechanical Brake Control Status Word Descriptions

P 5.12.1.1 Mechanical Brake Status Word

Table 37: Status Word Description

Bit Number	Bit Name	Description
0	Enabled	Mechanical brake is enabled by a parameter.
1	Start	A start signal is provided to mechanical brake control.
2	Brake open feedback signal	Brake feedback is enabled and brake open is active.
3	Brake close feedback	Brake feedback is enabled and brake closed is active.
4–10	N/A	
11	Priming	The required release torque could not be generated.
12	Brake release timeout	Feedback is enabled but brake open feedback was not provided during brake release time.
13	Brake close timeout	Feedback is enabled but brake close feedback was not provided during brake close time.
14	BrakeCtrl active	Brake control is either in progress of opening or closing brake.
15	Brake open	Brake control has activated digital output.

6.7.2.16 Maintenance & Service (Menu Index 6.1.1)

P 6.1.1.1 Last Fault Number

Description: Shows the number of the most recent active fault.

Default Value: NA	Parameter Type: Range (0 — 65535)	Parameter Number: 1610
Unit: -	Data Type: UINT	Access Type: Read Only

P 6.1.1.2 Last Warning Number

Description: Shows the number of the most recent active warning.

Default Value: NA	Parameter Type: Range (0 — 65535)	Parameter Number: 1609
Unit: -	Data Type: UINT	Access Type: Read Only

P 6.1.1.3 Control Unit Temperature

Description: Shows the temperature of the control unit.

Default Value: NA	Parameter Type: Range (-50 — 200)	Parameter Number: 2952
Unit: °C	Data Type: REAL	Access Type: Read Only

6.7.3 Software Information (Menu Index 6.2)

P 6.2.1 Application Version

Description: Shows the version of the application software.

Default Value: -	Parameter Type:	Parameter Number: 151
Unit:	Data Type: STRING	Access Type: -

S 6.2.4 Manifest

Description:

6.7.4 Events (Menu Index 6.4)

6.7.4.1 Event Simulation (Menu Index 6.4.3)

P 6.4.3.1 Simulate Event

Description: Select a response to trigger a simulated event.

Default Value: 0 [No Action]	Parameter Type: Selection	Parameter Number: 1400
Unit: -	Data Type: UINT	Access Type: Read/Write

The following are the selections for the parameter.

Selection Number	Selection Name	Selection Description
0	No Action	No event is triggered.
1	Response 1	Activate occurrence response 1.

Selection Number	Selection Name	Selection Description
2	Response 2	Activate occurrence response 2.
3	Response 3	Activate occurrence response 3.
4	Response 4	Activate occurrence response 4.
5	Response 5	Activate occurrence response 5.
6	Response 6	Activate occurrence response 6.
7	Response 7	Activate occurrence response 7.
8	Response 8	Activate occurrence response 8.
9	Response 9	Activate occurrence response 9.
10	Response 10	Activate occurrence response 10.

P 6.4.3.2 Simulate Persisting Event

Description: Select a response to trigger a persisting simulated event. Set back to 0 to allow a reset.

Default Value: 0 [No Action]	Parameter Type: Selection	Parameter Number: 1401
Unit: -	Data Type: UINT	Access Type: Read/Write

The following are the selections for the parameter.

Selection Number	Selection Name	Selection Description
0	No Action	No event is triggered.
1	Response 1	Activate occurrence response 1.
2	Response 2	Activate occurrence response 2.
3	Response 3	Activate occurrence response 3.
4	Response 4	Activate occurrence response 4.
5	Response 5	Activate occurrence response 5.
6	Response 6	Activate occurrence response 6.
7	Response 7	Activate occurrence response 7.
8	Response 8	Activate occurrence response 8.
9	Response 9	Activate occurrence response 9.
10	Response 10	Activate occurrence response 10.

P 6.4.3.3 Simulate Event Number

Description: Set the number of the event to be simulated.

Default Value: 5260	Parameter Type: Range (0 — 65535)	Parameter Number: 1402
Unit: -	Data Type: UINT	Access Type: Read/Write

6.7.4.2 Automatic Reset Function

The automatic reset function enables the resetting of events without the need for a manual reset operation. This function is enabled with parameter **6.4.4.1 Auto Reset**.

When the function is enabled, a timer starts when an event requiring a reset is first triggered. An automatic reset is attempted at the end of each time interval. If any event requiring a reset is still active, the automatic reset attempt does not succeed, and the timer continues running. Once the maximum number of automatic reset attempts is reached, the automatic reset function stops, and a manual reset is required to clear the events.

If all events are reset (through either an automatic or manual reset), the function resets the number of attempts and stops the timer. The next event to trigger will begin a new cycle.

NOTICE

Before activating any automatic fault reset functions or changing limit values, make sure that no dangerous situations can occur after restart. If the auto reset function is activated, the device connected to the drive output starts automatically after an automatic fault reset.

NOTICE

A small set of events cannot be reset by the auto reset functionality, either because of safety reasons or because the events are critical for the lifetime of the drive.

6.7.4.3 Auto Reset (Menu Index 6.4.4)

P 6.4.4.1 Auto Reset

Description: Enables the automatic resetting of events.

Default Value: 0 [Disabled]	Parameter Type: Selection	Parameter Number: 1405
Unit: -	Data Type: BOOL	Access Type: Read/Write

The following are the selections for the parameter.

Selection Number	Selection Name	Selection Description
0	Disabled	Disables the function.
1	Enabled	Enables the function.

P 6.4.4.2 Auto Reset Max Attempts

Description: Set the maximum number of automatic resets that is allowed before a manual reset is required. 0 means the drive will auto reset infinite times. Some events can not be auto reset due to hardware protection or for safety reasons.

Default Value: 3	Parameter Type: Range (0 — 20)	Parameter Number: 1406
Unit: -	Data Type: UINT	Access Type: Read/Write

P 6.4.4.3 Auto Reset Time Interval

Description: Set the time interval from when an event happens to when it is automatically reset.

Default Value: 10	Parameter Type: Range (1 — 600)	Parameter Number: 1407
Unit: s	Data Type: REAL	Access Type: Read/Write

6.7.5 Operational Counters (Menu Index 6.5)

P 6.5.1 Control Unit On Time

Description: Shows the total operating time for the control unit.

Default Value: 0	Parameter Type: Range (0 — 4294967295)	Parameter Number: 2000
Unit: h	Data Type: UDINT	Access Type: Read Only

P 6.5.2 Power Unit On Time

Description: Shows the total operating time for the power unit. The counter only increments if the DC link is powered.

Default Value: 0	Parameter Type: Range (0 — 4294967295)	Parameter Number: 2001
Unit: h	Data Type: UDINT	Access Type: Read Only

P 6.5.3 Energy Consumption

Description: Shows the energy consumed.

Default Value: 0	Parameter Type: Range (0 — 18446744073709600000)	Parameter Number: 2002
Unit: kWh	Data Type: ULINT	Access Type: Read Only

P 6.5.4 Ground Faults

Description: Shows the total number of ground faults.

Default Value: 0	Parameter Type: Range (0 — 50000)	Parameter Number: 2004
Unit: -	Data Type: UINT	Access Type: Read Only

P 6.5.5 Overvoltage Faults

Description: Shows the total number of overvoltage faults.

Default Value: 0	Parameter Type: Range (0 — 50000)	Parameter Number: 2005
Unit: -	Data Type: UINT	Access Type: Read Only

P 6.5.6 Overcurrent Faults

Description: Shows the total number of overcurrent faults.

Default Value: 0	Parameter Type: Range (0 — 50000)	Parameter Number: 2006
Unit: -	Data Type: UINT	Access Type: Read Only

P 6.5.7 Short Circuit Faults

Description: Shows the total number of short-circuit faults.

Default Value: 0	Parameter Type: Range (0 — 50000)	Parameter Number: 2007
Unit: -	Data Type: UINT	Access Type: Read Only

P 6.5.8 Number Of Starts

Description: Shows the number of starts of the motor.

Default Value: 0	Parameter Type: Range (0 — 4294967295)	Parameter Number: 2008
Unit: -	Data Type: UDINT	Access Type: Read Only

P 6.5.9 Active Running Hours

Description: Shows the total number of active running hours of the motor.

Default Value: 0	Parameter Type: Range (0 — 4294967295)	Parameter Number: 2009
Unit: h	Data Type: UDINT	Access Type: Read Only

P 6.5.10 Motor Operation Below 10 Hz

Description: Shows the number of hours of running below 10 Hz output frequency. Low speed operation with full load may decrease motor lifetime.

Default Value: 0	Parameter Type: Range (0 — 4294967295)	Parameter Number: 2010
Unit: h	Data Type: UDINT	Access Type: Read Only

6.8 Functional Safety (Menu Index 7)

6.8.1 Functional Safety Overview

NOTICE

Select and apply the components in the safety control system appropriately to achieve the required level of operational safety. Before integrating and using STO in an installation, carry out a thorough risk analysis on the installation to determine whether the STO functionality and safety levels are appropriate and sufficient.

This parameter group contains non-safety-related parameters. They are used to configure the behavior of the drive after a functional safety event (for example, STO). Refer to Functional Safety Operating Guide for more information.

6.8.2 Status (Menu Index 7.1)

P 7.1.1 Functional Safety Status Word

Description: Shows the functional safety status word.

Default Value: NA	Parameter Type: Range (* — *)	Parameter Number: 4024
Unit: -	Data Type: WORD	Access Type: Read Only

6.8.3 Basic Settings

P 7.2.1 Startup Acknowledge Input

Description: Select the input for acknowledging a safe startup.

Default Value:	Parameter Type: Selection	Parameter Number: 9922
Unit: -	Data Type: UINT	Access Type: Read/Write

P 7.2.2 I/O Failure Acknowledge Input

Description: Select the input for acknowledging a safe I/O failure.

Default Value:	Parameter Type: Selection	Parameter Number: 9921
Unit: -	Data Type: UINT	Access Type: Read/Write

6.8.4 Safe Torque Off (STO)

The Safe Torque Off (STO) function is a component in a safety control system. STO prevents the unit from generating the power required to rotate the motor. The iC7 drives are available with:

- Safe Torque Off (STO), as defined by EN IEC 61800-5-2.
- Stop category O, as defined in EN 60204-1.

STO Activation

The STO function is activated by removing the voltages at the STO inputs of the drive. By connecting the frequency converter to external safety devices providing a safe delay, an installation for a Safe Stop 1 can be obtained. External safety devices must fulfill the required Cat.IPL or SIL when connected to STO inputs.

With default settings, the drive issues a fault, trips the unit, and coasts the motor to a stop when the STO function is activated. A manual restart is required to continue operation. Use the STO function to stop the drive when a safety function is required. In normal operating mode when STO is not required, use the standard stop function instead.

6.8.5 STO (Menu Index 7.3)

P 7.3.1 Safe Torque Off Response

Description: Select the response of the drive to the activation of Safe Torque Off.

Default Value: 14 [Fault]	Parameter Type: Selection	Parameter Number: 9910
Unit: -	Data Type: UINT	Access Type: Read/Write

The following are the selections for the parameter.

Selection Number	Selection Name	Selection Description
15	Warning	The drive issues a warning.
14	Fault	The drive issues a fault and coasts the motor.

P 7.3.2 Safe Torque Off Output

Description: Select an output for signaling the activation of Safe Torque Off.

Default Value:	Parameter Type: Selection	Parameter Number: 9911
Unit: -	Data Type: UINT	Access Type: Read/Write

6.8.6 Terminating STO and Resuming Normal Operation

1. Reapply 24 V DC supply to STO inputs.
2. Give a reset signal (via bus, digital I/O, or the control panel).

Set the STO function to restart automatically by setting the default value in parameter **7.2.1 Safe Torque Off Reaction**. This way, STO is terminated and normal operation is resumed, when the 24 V DC is applied to STO inputs. No reset signal is required.

6.8.7 SS1 SS2 (Menu Index 7.4)

P 7.4.1 Safe Stop 1 Response

Description: Select the response if there is a Safe Stop 1 event (Only available with safety module).

Default Value: 0 [No response]	Parameter Type: Selection	Parameter Number: 9901
Unit: -	Data Type: UINT	Access Type: Read/Write

The following are the selections for the parameter.

Selection Number	Selection Name	Selection Description
0	No response	The drive detects that Safe Stop is activated, but relies on external action to stop. If no action is taken, a fault is generated.
1	Stop with Safe Ramp	The drive detects that Safe Stop is activated and ramps down using the configured ramp. If unsuccessful, a fault is generated.

P 7.4.2 Safe Stop 2 Response

Description: Select the response if there is a Safe Stop 2 event (Only available with safety module).

Default Value: 0 [No response]	Parameter Type: Selection	Parameter Number: 9902
Unit: -	Data Type: UINT	Access Type: Read/Write

The following are the selections for the parameter.

Selection Number	Selection Name	Selection Description
0	No response	The drive detects that Safe Stop is activated, but relies on external action to stop. If no action is taken, a fault is generated.
1	Stop with Safe Ramp	The drive detects that Safe Stop is activated and ramps down using the configured ramp. If unsuccessful, a fault is generated.

P 7.4.3 Safe Deceleration Ramp

Description: Set Deceleration Ramp if there is a Safe Stop event (Only available with safety module).

Default Value: 0	Parameter Type: Range (0 — 10000)	Parameter Number: 9900
Unit: s	Data Type: REAL	Access Type: Read/Write

6.9 Customization (Menu Index 8)

6.9.1 Customization Overview

This parameter group contains parameters for customizing and adapting the behavior of the drive and user interface design.

6.9.2 Basic Settings (Menu Index 8.2)

P 8.2.1 Date and Time

Description: Set the actual time and date. Format is YYYY-MM-DD and HH:MM:SS.

Default Value:	Parameter Type: Range (* — *)	Parameter Number: 2800
Unit: -	Data Type: DATE_AND_TIME	Access Type: Read/Write

P 8.2.2 Unit Selection

Description: Select the unit system used.

Default Value: *	Parameter Type: Selection	Parameter Number: 2801
Unit: -	Data Type: USINT	Access Type: Read/Write

The following are the selections for the parameter.

Selection Number	Selection Name	Selection Description
0	SI (metric units)	International system of units.
1	USCS (United States customary units)	United States customary units.

P 8.2.3 Speed Unit

Description: Select the speed unit.

Default Value: 1 [RPM]	Parameter Type: Selection	Parameter Number: 2813
Unit: -	Data Type: USINT	Access Type: Read/Write

The following are the selections for the parameter.

Selection Number	Selection Name	Selection Description
0	Hz	Use Hz as speed unit.
1	RPM	Use RPM as speed unit.

6.9.3 Control Panel (Menu Index 8.3)

6.9.3.1 Readout Screen 1 (Menu Index 8.3.1)

P 8.3.1.1 Readout Field 1.1

Description: Select the parameter for readout field (screen 1 field 1).

Default Value: 0 [Automatic]	Parameter Type: Selection	Parameter Number: 300
Unit: -	Data Type: UDINT	Access Type: Read/Write

The following are the selections for the parameter.

Selection Number	Selection Name	Selection Description
0	Automatic	Automatically shows the actual value of the selected control mode, for example speed or torque.
9011	Motor Speed	Shows the actual motor speed.
9000	Motor Current	Shows the actual motor current.
9010	Motor Shaft Speed	Shows the shaft speed in RPM.
9009	Motor Torque	Shows the actual motor torque.
1708	Relative Motor Torque	Shows the motor torque in % of the nominal motor torque.
9008	Motor Shaft Power	Shows the actual power at the motor shaft.
6075	Process Controller Output	Shows the process controller's output as normalized value (in the range 0 to 1).
6090	Feedback Value	Shows the actual value of the feedback.
1718	Speed Reference	Shows the speed reference.
6092	Setpoint Value	Shows the actual value of the setpoint.
6151	Final Speed Reference	Shows the value of the speed reference before feeding it to the speed controller.
9007	Feedback Speed	Shows the feedback speed.

P 8.3.1.2 Readout Field 1.2

Description: Select the parameter for readout field (screen 1 field 2).

Default Value: 0 [None]	Parameter Type: Selection	Parameter Number: 301
Unit: -	Data Type: UDINT	Access Type: Read/Write

The following are the selections for the parameter.

Selection Number	Selection Name	Selection Description
0	None	Nothing selected.
9011	Motor Speed	Shows the actual motor speed.
9000	Motor Current	Shows the actual motor current.
9010	Motor Shaft Speed	Shows the shaft speed in RPM.
9009	Motor Torque	Shows the actual motor torque.
1708	Relative Motor Torque	Shows the motor torque in % of the nominal motor torque.
9005	Motor Voltage	Shows the actual motor voltage.

Selection Number	Selection Name	Selection Description
9008	Motor Shaft Power	Shows the actual power at the motor shaft.
674	Load Drooping Speed	Shows the load drooping speed.
666	Estimated Inertia	
6075	Process Controller Output	Shows the process controller's output as normalized value (in the range 0 to 1).
6090	Feedback Value	Shows the actual value of the feedback.
1718	Speed Reference	Shows the speed reference.
6092	Setpoint Value	Shows the actual value of the setpoint.
6151	Final Speed Reference	Shows the value of the speed reference before feeding it to the speed controller.
6153	Control Panel Speed Reference	Shows the value of the speed reference given from the control panel.
6155	Local Torque Reference	Shows the local torque reference set in the control panel.
9007	Feedback Speed	Shows the feedback speed.
9044	DC-link Voltage	Shows the actual DC-link voltage.
9041	Grid Frequency	Shows the actual grid frequency.
9040	Line-To-Line Voltage (RMS)	Shows the average line-to-line voltage (RMS).
9048	L1-L2 Line Voltage (RMS)	Shows the L1-L2 line voltage (RMS).
9049	L2-L3 Line Voltage (RMS)	Shows the L2-L3 line voltage (RMS).
9050	L3-L1 Line Voltage (RMS)	Shows the L3-L1 line voltage (RMS).
9047	Grid Voltage Imbalance	Shows the grid voltage imbalance in %. A value greater than 3% may indicate grid problems.

P 8.3.1.3 Readout Field 1.3

Description: Select the parameter for readout field (screen 1 field 3).

Default Value: 0 [None]	Parameter Type: Selection	Parameter Number: 302
Unit: -	Data Type: UDINT	Access Type: Read/Write

The following are the selections for the parameter.

Selection Number	Selection Name	Selection Description
0	None	Nothing selected.
9011	Motor Speed	Shows the actual motor speed.
9000	Motor Current	Shows the actual motor current.
9010	Motor Shaft Speed	Shows the shaft speed in RPM.
9009	Motor Torque	Shows the actual motor torque.
1708	Relative Motor Torque	Shows the motor torque in % of the nominal motor torque.
9005	Motor Voltage	Shows the actual motor voltage.
9008	Motor Shaft Power	Shows the actual power at the motor shaft.
674	Load Drooping Speed	Shows the load drooping speed.
666	Estimated Inertia	
6075	Process Controller Output	Shows the process controller's output as normalized value (in the range 0 to 1).
6090	Feedback Value	Shows the actual value of the feedback.
1718	Speed Reference	Shows the speed reference.
6092	Setpoint Value	Shows the actual value of the setpoint.
6151	Final Speed Reference	Shows the value of the speed reference before feeding it to the speed controller.
6153	Control Panel Speed Reference	Shows the value of the speed reference given from the control panel.
6155	Local Torque Reference	Shows the local torque reference set in the control panel.
9007	Feedback Speed	Shows the feedback speed.
9044	DC-link Voltage	Shows the actual DC-link voltage.
9041	Grid Frequency	Shows the actual grid frequency.
9040	Line-To-Line Voltage (RMS)	Shows the average line-to-line voltage (RMS).
9048	L1-L2 Line Voltage (RMS)	Shows the L1-L2 line voltage (RMS).
9049	L2-L3 Line Voltage (RMS)	Shows the L2-L3 line voltage (RMS).
9050	L3-L1 Line Voltage (RMS)	Shows the L3-L1 line voltage (RMS).
9047	Grid Voltage Imbalance	Shows the grid voltage imbalance in %. A value greater than 3% may indicate grid problems.

P 8.3.1.4 Readout Field 1.4

Description: Select the parameter for readout field (screen 1 field 4).

Default Value: 0 [None]	Parameter Type: Selection	Parameter Number: 303
Unit: -	Data Type: UDINT	Access Type: Read/Write

The following are the selections for the parameter.

Selection Number	Selection Name	Selection Description
0	None	Nothing selected.
9011	Motor Speed	Shows the actual motor speed.
9000	Motor Current	Shows the actual motor current.
9010	Motor Shaft Speed	Shows the shaft speed in RPM.
9009	Motor Torque	Shows the actual motor torque.
1708	Relative Motor Torque	Shows the motor torque in % of the nominal motor torque.
9005	Motor Voltage	Shows the actual motor voltage.
9008	Motor Shaft Power	Shows the actual power at the motor shaft.
674	Load Drooping Speed	Shows the load drooping speed.
666	Estimated Inertia	
6075	Process Controller Output	Shows the process controller's output as normalized value (in the range 0 to 1).
6090	Feedback Value	Shows the actual value of the feedback.
1718	Speed Reference	Shows the speed reference.
6092	Setpoint Value	Shows the actual value of the setpoint.
6151	Final Speed Reference	Shows the value of the speed reference before feeding it to the speed controller.
6153	Control Panel Speed Reference	Shows the value of the speed reference given from the control panel.
6155	Local Torque Reference	Shows the local torque reference set in the control panel.
9007	Feedback Speed	Shows the feedback speed.
9044	DC-link Voltage	Shows the actual DC-link voltage.
9041	Grid Frequency	Shows the actual grid frequency.
9040	Line-To-Line Voltage (RMS)	Shows the average line-to-line voltage (RMS).
9048	L1-L2 Line Voltage (RMS)	Shows the L1-L2 line voltage (RMS).
9049	L2-L3 Line Voltage (RMS)	Shows the L2-L3 line voltage (RMS).

Selection Number	Selection Name	Selection Description
9050	L3-L1 Line Voltage (RMS)	Shows the L3-L1 line voltage (RMS).
9047	Grid Voltage Imbalance	Shows the grid voltage imbalance in %. A value greater than 3% may indicate grid problems.

P 8.3.1.5 Readout Field 1.5

Description: Select the parameter for readout field (screen 1 field 5).

Default Value: 0 [None]	Parameter Type: Selection	Parameter Number: 304
Unit: -	Data Type: UDINT	Access Type: Read/Write

The following are the selections for the parameter.

Selection Number	Selection Name	Selection Description
0	None	Nothing selected.
9011	Motor Speed	Shows the actual motor speed.
9000	Motor Current	Shows the actual motor current.
9010	Motor Shaft Speed	Shows the shaft speed in RPM.
9009	Motor Torque	Shows the actual motor torque.
1708	Relative Motor Torque	Shows the motor torque in % of the nominal motor torque.
9005	Motor Voltage	Shows the actual motor voltage.
9008	Motor Shaft Power	Shows the actual power at the motor shaft.
674	Load Drooping Speed	Shows the load drooping speed.
666	Estimated Inertia	
6075	Process Controller Output	Shows the process controller's output as normalized value (in the range 0 to 1).
6090	Feedback Value	Shows the actual value of the feedback.
1718	Speed Reference	Shows the speed reference.
6092	Setpoint Value	Shows the actual value of the setpoint.
6151	Final Speed Reference	Shows the value of the speed reference before feeding it to the speed controller.
6153	Control Panel Speed Reference	Shows the value of the speed reference given from the control panel.
6155	Local Torque Reference	Shows the local torque reference set in the control panel.

Selection Number	Selection Name	Selection Description
9007	Feedback Speed	Shows the feedback speed.
9044	DC-link Voltage	Shows the actual DC-link voltage.
9041	Grid Frequency	Shows the actual grid frequency.
9040	Line-To-Line Voltage (RMS)	Shows the average line-to-line voltage (RMS).
9048	L1-L2 Line Voltage (RMS)	Shows the L1-L2 line voltage (RMS).
9049	L2-L3 Line Voltage (RMS)	Shows the L2-L3 line voltage (RMS).
9050	L3-L1 Line Voltage (RMS)	Shows the L3-L1 line voltage (RMS).
9047	Grid Voltage Imbalance	Shows the grid voltage imbalance in %. A value greater than 3% may indicate grid problems.

6.9.3.2 Readout Screen 2 (Menu Index 8.3.2)

P 8.3.2.1 Readout Field 2.1

Description: Select the parameter for readout field (screen 2 field 1).

Default Value: 9010 [Motor Shaft Speed]	Parameter Type: Selection	Parameter Number: 310
Unit: -	Data Type: UDINT	Access Type: Read/Write

The following are the selections for the parameter.

Selection Number	Selection Name	Selection Description
0	None	Nothing selected.
9011	Motor Speed	Shows the actual motor speed.
9000	Motor Current	Shows the actual motor current.
9010	Motor Shaft Speed	Shows the shaft speed in RPM.
9009	Motor Torque	Shows the actual motor torque.
1708	Relative Motor Torque	Shows the motor torque in % of the nominal motor torque.
9005	Motor Voltage	Shows the actual motor voltage.
9008	Motor Shaft Power	Shows the actual power at the motor shaft.
674	Load Drooping Speed	Shows the load drooping speed.
666	Estimated Inertia	
6075	Process Controller Output	Shows the process controller's output as normalized value (in the range 0 to 1).
6090	Feedback Value	Shows the actual value of the feedback.

Selection Number	Selection Name	Selection Description
1718	Speed Reference	Shows the speed reference.
6092	Setpoint Value	Shows the actual value of the setpoint.
6151	Final Speed Reference	Shows the value of the speed reference before feeding it to the speed controller.
6153	Control Panel Speed Reference	Shows the value of the speed reference given from the control panel.
6155	Local Torque Reference	Shows the local torque reference set in the control panel.
9007	Feedback Speed	Shows the feedback speed.
9044	DC-link Voltage	Shows the actual DC-link voltage.
9041	Grid Frequency	Shows the actual grid frequency.
9040	Line-To-Line Voltage (RMS)	Shows the average line-to-line voltage (RMS).
9048	L1-L2 Line Voltage (RMS)	Shows the L1-L2 line voltage (RMS).
9049	L2-L3 Line Voltage (RMS)	Shows the L2-L3 line voltage (RMS).
9050	L3-L1 Line Voltage (RMS)	Shows the L3-L1 line voltage (RMS).
9047	Grid Voltage Imbalance	Shows the grid voltage imbalance in %. A value greater than 3% may indicate grid problems.

P 8.3.2.2 Readout Field 2.2

Description: Select the parameter for readout field (screen 2 field 2).

Default Value: 9009 [Motor Torque]	Parameter Type: Selection	Parameter Number: 311
Unit: -	Data Type: UDINT	Access Type: Read/Write

The following are the selections for the parameter.

Selection Number	Selection Name	Selection Description
0	None	Nothing selected.
9011	Motor Speed	Shows the actual motor speed.
9000	Motor Current	Shows the actual motor current.
9010	Motor Shaft Speed	Shows the shaft speed in RPM.
9009	Motor Torque	Shows the actual motor torque.
1708	Relative Motor Torque	Shows the motor torque in % of the nominal motor torque.
9005	Motor Voltage	Shows the actual motor voltage.

Selection Number	Selection Name	Selection Description
9008	Motor Shaft Power	Shows the actual power at the motor shaft.
674	Load Drooping Speed	Shows the load drooping speed.
666	Estimated Inertia	
6075	Process Controller Output	Shows the process controller's output as normalized value (in the range 0 to 1).
6090	Feedback Value	Shows the actual value of the feedback.
1718	Speed Reference	Shows the speed reference.
6092	Setpoint Value	Shows the actual value of the setpoint.
6151	Final Speed Reference	Shows the value of the speed reference before feeding it to the speed controller.
6153	Control Panel Speed Reference	Shows the value of the speed reference given from the control panel.
6155	Local Torque Reference	Shows the local torque reference set in the control panel.
9007	Feedback Speed	Shows the feedback speed.
9044	DC-link Voltage	Shows the actual DC-link voltage.
9041	Grid Frequency	Shows the actual grid frequency.
9040	Line-To-Line Voltage (RMS)	Shows the average line-to-line voltage (RMS).
9048	L1-L2 Line Voltage (RMS)	Shows the L1-L2 line voltage (RMS).
9049	L2-L3 Line Voltage (RMS)	Shows the L2-L3 line voltage (RMS).
9050	L3-L1 Line Voltage (RMS)	Shows the L3-L1 line voltage (RMS).
9047	Grid Voltage Imbalance	Shows the grid voltage imbalance in %. A value greater than 3% may indicate grid problems.

P 8.3.2.3 Readout Field 2.3

Description: Select the parameter for readout field (screen 2 field 3).

Default Value: 9008 [Motor Shaft Power]	Parameter Type: Selection	Parameter Number: 312
Unit: -	Data Type: UDINT	Access Type: Read/Write

The following are the selections for the parameter.

Selection Number	Selection Name	Selection Description
0	None	Nothing selected.
9011	Motor Speed	Shows the actual motor speed.
9000	Motor Current	Shows the actual motor current.
9010	Motor Shaft Speed	Shows the shaft speed in RPM.
9009	Motor Torque	Shows the actual motor torque.
1708	Relative Motor Torque	Shows the motor torque in % of the nominal motor torque.
9005	Motor Voltage	Shows the actual motor voltage.
9008	Motor Shaft Power	Shows the actual power at the motor shaft.
674	Load Drooping Speed	Shows the load drooping speed.
666	Estimated Inertia	
6075	Process Controller Output	Shows the process controller's output as normalized value (in the range 0 to 1).
6090	Feedback Value	Shows the actual value of the feedback.
1718	Speed Reference	Shows the speed reference.
6092	Setpoint Value	Shows the actual value of the setpoint.
6151	Final Speed Reference	Shows the value of the speed reference before feeding it to the speed controller.
6153	Control Panel Speed Reference	Shows the value of the speed reference given from the control panel.
6155	Local Torque Reference	Shows the local torque reference set in the control panel.
9007	Feedback Speed	Shows the feedback speed.
9044	DC-link Voltage	Shows the actual DC-link voltage.
9041	Grid Frequency	Shows the actual grid frequency.
9040	Line-To-Line Voltage (RMS)	Shows the average line-to-line voltage (RMS).
9048	L1-L2 Line Voltage (RMS)	Shows the L1-L2 line voltage (RMS).
9049	L2-L3 Line Voltage (RMS)	Shows the L2-L3 line voltage (RMS).
9050	L3-L1 Line Voltage (RMS)	Shows the L3-L1 line voltage (RMS).
9047	Grid Voltage Imbalance	Shows the grid voltage imbalance in %. A value greater than 3% may indicate grid problems.

P 8.3.2.4 Readout Field 2.4

Description: Select the parameter for readout field (screen 2 field 4).

Default Value: 0 [None]	Parameter Type: Selection	Parameter Number: 313
Unit: -	Data Type: UDINT	Access Type: Read/Write

The following are the selections for the parameter.

Selection Number	Selection Name	Selection Description
0	None	Nothing selected.
9011	Motor Speed	Shows the actual motor speed.
9000	Motor Current	Shows the actual motor current.
9010	Motor Shaft Speed	Shows the shaft speed in RPM.
9009	Motor Torque	Shows the actual motor torque.
1708	Relative Motor Torque	Shows the motor torque in % of the nominal motor torque.
9005	Motor Voltage	Shows the actual motor voltage.
9008	Motor Shaft Power	Shows the actual power at the motor shaft.
674	Load Drooping Speed	Shows the load drooping speed.
666	Estimated Inertia	
6075	Process Controller Output	Shows the process controller's output as normalized value (in the range 0 to 1).
6090	Feedback Value	Shows the actual value of the feedback.
1718	Speed Reference	Shows the speed reference.
6092	Setpoint Value	Shows the actual value of the setpoint.
6151	Final Speed Reference	Shows the value of the speed reference before feeding it to the speed controller.
6153	Control Panel Speed Reference	Shows the value of the speed reference given from the control panel.
6155	Local Torque Reference	Shows the local torque reference set in the control panel.
9007	Feedback Speed	Shows the feedback speed.
9044	DC-link Voltage	Shows the actual DC-link voltage.
9041	Grid Frequency	Shows the actual grid frequency.
9040	Line-To-Line Voltage (RMS)	Shows the average line-to-line voltage (RMS).
9048	L1-L2 Line Voltage (RMS)	Shows the L1-L2 line voltage (RMS).
9049	L2-L3 Line Voltage (RMS)	Shows the L2-L3 line voltage (RMS).

Selection Number	Selection Name	Selection Description
9050	L3-L1 Line Voltage (RMS)	Shows the L3-L1 line voltage (RMS).
9047	Grid Voltage Imbalance	Shows the grid voltage imbalance in %. A value greater than 3% may indicate grid problems.

P 8.3.2.5 Readout Field 2.5

Description: Select the parameter for readout field (screen 2 field 5).

Default Value: 0 [None]	Parameter Type: Selection	Parameter Number: 314
Unit: -	Data Type: UDINT	Access Type: Read/Write

The following are the selections for the parameter.

Selection Number	Selection Name	Selection Description
0	None	Nothing selected.
9011	Motor Speed	Shows the actual motor speed.
9000	Motor Current	Shows the actual motor current.
9010	Motor Shaft Speed	Shows the shaft speed in RPM.
9009	Motor Torque	Shows the actual motor torque.
1708	Relative Motor Torque	Shows the motor torque in % of the nominal motor torque.
9005	Motor Voltage	Shows the actual motor voltage.
9008	Motor Shaft Power	Shows the actual power at the motor shaft.
674	Load Drooping Speed	Shows the load drooping speed.
666	Estimated Inertia	
6075	Process Controller Output	Shows the process controller's output as normalized value (in the range 0 to 1).
6090	Feedback Value	Shows the actual value of the feedback.
1718	Speed Reference	Shows the speed reference.
6092	Setpoint Value	Shows the actual value of the setpoint.
6151	Final Speed Reference	Shows the value of the speed reference before feeding it to the speed controller.
6153	Control Panel Speed Reference	Shows the value of the speed reference given from the control panel.
6155	Local Torque Reference	Shows the local torque reference set in the control panel.

Selection Number	Selection Name	Selection Description
9007	Feedback Speed	Shows the feedback speed.
9044	DC-link Voltage	Shows the actual DC-link voltage.
9041	Grid Frequency	Shows the actual grid frequency.
9040	Line-To-Line Voltage (RMS)	Shows the average line-to-line voltage (RMS).
9048	L1-L2 Line Voltage (RMS)	Shows the L1-L2 line voltage (RMS).
9049	L2-L3 Line Voltage (RMS)	Shows the L2-L3 line voltage (RMS).
9050	L3-L1 Line Voltage (RMS)	Shows the L3-L1 line voltage (RMS).
9047	Grid Voltage Imbalance	Shows the grid voltage imbalance in %. A value greater than 3% may indicate grid problems.

6.10 I/O (Menu Index 9)

6.10.1 I/O Overview

Parameter group 9 contains the parameters for the hardware configuration of the I/Os such as terminal modes, filtering of the electrical signals and signal ranges.

This Application Guide contains only the parameter descriptions for the Basic I/O. The parameter information for option boards such as the Encoder/Resolver Option OC7M0 can be found in the iC7 Functional Extensions Operating Guide.

6.10.2 Basic I/O

6.10.2.1 I/O Status (Menu Index 9.3)

P 9.3.1 Digital Input Status

Description: Shows the digital input I/O word. Each bit represents the status of a digital input.

Default Value: NA	Parameter Type: Range (* — *)	Parameter Number: 1614
Unit: -	Data Type: WORD	Access Type: Read Only

P 9.3.2 Digital Output Status

Description: Shows the digital output I/O word. Each bit represents the status of a digital output.

Default Value: NA	Parameter Type: Range (* — *)	Parameter Number: 1615
Unit: -	Data Type: WORD	Access Type: Read Only

P 9.3.3 T31 Analog Output Value

Description: Shows the actual value of the terminal.

Default Value: NA	Parameter Type: Range (0 — 20)	Parameter Number: 1613
Unit: -	Data Type: REAL	Access Type: Read Only

P 9.3.4 T33 Analog Input Value

Description: Shows the actual value of the terminal.

Default Value: NA	Parameter Type: Range (-20 — 20)	Parameter Number: 1611
Unit: -	Data Type: REAL	Access Type: Read Only

P 9.3.5 T34 Analog Input Value

Description: Shows the actual value of the terminal.

Default Value: NA	Parameter Type: Range (-20 — 20)	Parameter Number: 1612
Unit: -	Data Type: REAL	Access Type: Read Only

P 9.3.6 T34 Temperature Value

Description: Shows the measured temperature of the terminal.

Default Value: NA	Parameter Type: Range (-1000 — 1000)	Parameter Number: 1616
Unit: °C	Data Type: REAL	Access Type: Read Only

6.10.2.2 I/O Status Bits

P 9.3.1 Digital Input Status

Table 38: I/O Digital Input Status Bits

Bit	Description
00	DigIn13
01	DigIn14
02	DigIn15
03	DigIn16
04	DigIn17
05	DigIn18
06–15	Not used

P 9.3.2 Digital Output Status

Table 39: I/O Digital Output Status Bits

Bit	Description
00–01	Not used
02	DigOut15
03	DigOut16
04–11	Not used
12	Relay02
13	Relay05
14–15	Not used

6.10.2.3 Digital Inputs/Outputs (Menu Index 9.4)

6.10.2.3.1 Pulse Input

A digital input can be configured to be a pulse input with the corresponding mode parameter. The pulse input can be used as a speed reference, similarly to how an analog input signal works. The pulse input can come from a sensor, an HTL encoder, or other devices.

When pulse input is selected as the input type, the only active parameters for that input are the pulse min. and max. frequency parameters. The right filter is selected automatically for the incoming signal by the drive, so the parameters for the filters are not active when pulse input is selected.

The set pulse minimum and maximum frequencies correspond to the set minimum and maximum speed references defined in parameter group **5.8.4 Speed Reference**.

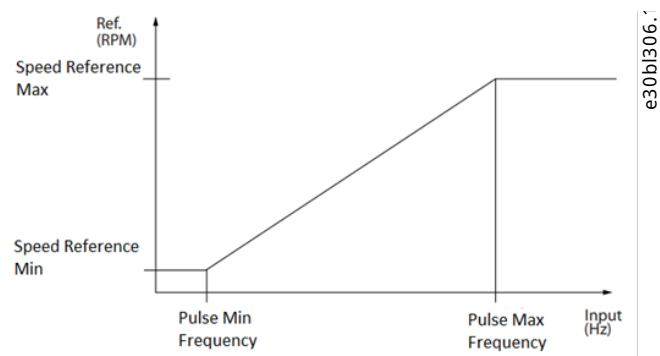

Figure 75: Pulse Input

6.10.2.3.2 General Settings (Menu Index 9.4.1)

P 9.4.1.1 Digital Input Logic

Description: Set the operating logic for all digital inputs.

Default Value: 2 [PNP mode]	Parameter Type: Selection	Parameter Number: 2261
Unit: -	Data Type: UINT	Access Type: Read/Write

The following are the selections for the parameter.

Selection Number	Selection Name	Selection Description
1	NPN mode	Open collector sink (NPN).
2	PNP mode	Open collector source (PNP).

6.10.2.3.3 Input T13 (Menu Index 9.4.2)

P 9.4.2.1 T13 Terminal Mode

Description: Select the mode for the terminal.

Default Value: 3 [Digital input]	Parameter Type: Selection	Parameter Number: 2015
Unit: -	Data Type: UINT	Access Type: Read/Write

The following are the selections for the parameter.

Selection Number	Selection Name	Selection Description
0	Inactive	
3	Digital input	The terminal is configured as boolean input (true/false).
4	Pulse input	The terminal is configured as pulse input. The frequency represents an analog value.

P 9.4.2.2 T13 Signal Inversion

Description: Select whether the signal of the terminal is inverted.

Default Value: 0 [Non-Inverted]	Parameter Type: Selection	Parameter Number: 2291
Unit: -	Data Type: UINT	Access Type: Read/Write

The following are the selections for the parameter.

Selection Number	Selection Name	Selection Description
0	Non-Inverted	The signal is not inverted.
1	Inverted	The signal is logically inverted.

P 9.4.2.3 T13 Fast Debounce Filtering Time

Description: Set the fast debounce filtering time for the terminal.

Default Value: 0.00	Parameter Type: Range (0.00 — 63.50)	Parameter Number: 2285
Unit: μ s	Data Type: REAL	Access Type: Read/Write

P 9.4.2.4 T13 Standard Debounce Filtering Time

Description: Set the standard debounce filtering time for the terminal.

Default Value: 5.00	Parameter Type: Range (0.00 — 127.00)	Parameter Number: 2024
Unit: ms	Data Type: REAL	Access Type: Read/Write

P 9.4.2.5 T13 Reaction Time

Description: Select the reaction time for the debounce filter.

Default Value: 0 [Standard reaction time (1ms tick)]	Parameter Type: Selection	Parameter Number: 2025
Unit: -	Data Type: UINT	Access Type: Read/Write

The following are the selections for the parameter.

Selection Number	Selection Name	Selection Description
0	Standard reaction time (1ms tick)	Use the digital input in the same way as other inputs.
1	Fast reaction time (0.5 μ s tick)	Enables fast reaction time for certain event via digital input.

P 9.4.2.6 T13 Trigger Mode

Description: Select the trigger mode for the digital input.

Default Value: 0 [None]	Parameter Type: Selection	Parameter Number: 2026
Unit: -	Data Type: UINT	Access Type: Read/Write

The following are the selections for the parameter.

Selection Number	Selection Name	Selection Description
0	None	No event trigger.
1	Rising Edge	Trig event at rising edge.
2	Falling Edge	Trig event at falling edge.
3	Both Edges	Trig event at both rising and falling edge.

P 9.4.2.7 T13 Pulse Min. Frequency

Description: Set the frequency representing 0% of the signal.

Default Value: 0	Parameter Type: Range (0 — 110000)	Parameter Number: 2027
Unit: Hz	Data Type: REAL	Access Type: Read/Write

P 9.4.2.8 T13 Pulse Max. Frequency

Description: Set the frequency representing 100% of the signal.

Default Value: 110000	Parameter Type: Range (0 — 110000)	Parameter Number: 2028
Unit: Hz	Data Type: REAL	Access Type: Read/Write

6.10.2.3.4 Input T14 (Menu Index 9.4.3)

P 9.4.3.1 T14 Terminal Mode

Description: Select the mode for the terminal.

Default Value: 3 [Digital input]	Parameter Type: Selection	Parameter Number: 2016
Unit: -	Data Type: UINT	Access Type: Read/Write

The following are the selections for the parameter.

Selection Number	Selection Name	Selection Description
0	Inactive	
3	Digital input	The terminal is configured as boolean input (true/false).
4	Pulse input	The terminal is configured as pulse input. The frequency represents an analog value.

P 9.4.3.2 T14 Signal Inversion

Description: Select whether the signal of the terminal is inverted.

Default Value: 0 [Non-Inverted]	Parameter Type: Selection	Parameter Number: 2292
Unit: -	Data Type: UINT	Access Type: Read/Write

The following are the selections for the parameter.

Selection Number	Selection Name	Selection Description
0	Non-Inverted	The signal is not inverted.
1	Inverted	The signal is logically inverted.

P 9.4.3.3 T14 Fast Debounce Filtering Time

Description: Set the fast debounce filtering time for the terminal.

Default Value: 0.00	Parameter Type: Range (0.00 — 63.50)	Parameter Number: 2286
Unit: μ s	Data Type: REAL	Access Type: Read/Write

P 9.4.3.4 T14 Standard Debounce Filtering Time

Description: Set the standard debounce filtering time for the terminal.

Default Value: 5.00	Parameter Type: Range (0.00 — 127.00)	Parameter Number: 2029
Unit: ms	Data Type: REAL	Access Type: Read/Write

P 9.4.3.5 T14 Reaction Time

Description: Select the reaction time for the debounce filter.

Default Value: 0 [Standard reaction time (1ms tick)]	Parameter Type: Selection	Parameter Number: 2030
Unit: -	Data Type: UINT	Access Type: Read/Write

The following are the selections for the parameter.

Selection Number	Selection Name	Selection Description
0	Standard reaction time (1ms tick)	Use the digital input in the same way as other inputs.
1	Fast reaction time (0.5µs tick)	Enables fast reaction time for certain event via digital input.

P 9.4.3.6 T14 Trigger Mode

Description: Select the trigger mode for the digital input.

Default Value: 0 [None]	Parameter Type: Selection	Parameter Number: 2031
Unit: -	Data Type: UINT	Access Type: Read/Write

The following are the selections for the parameter.

Selection Number	Selection Name	Selection Description
0	None	No event trigger.
1	Rising Edge	Trig event at rising edge.
2	Falling Edge	Trig event at falling edge.
3	Both Edges	Trig event at both rising and falling edge.

P 9.4.3.7 T14 Pulse Min. Frequency

Description: Set the frequency representing 0% of the signal.

Default Value: 0	Parameter Type: Range (0 — 110000)	Parameter Number: 2032
Unit: Hz	Data Type: REAL	Access Type: Read/Write

P 9.4.3.8 T14 Pulse Max. Frequency

Description: Set the frequency representing 100% of the signal.

Default Value: 110000	Parameter Type: Range (0 — 110000)	Parameter Number: 2033
Unit: Hz	Data Type: REAL	Access Type: Read/Write

6.10.2.3.5 Input/Output T15 (Menu Index 9.4.4)

P 9.4.4.1 T15 Terminal Mode

Description: Select the mode for the terminal.

Default Value: 3 [Digital input]	Parameter Type: Selection	Parameter Number: 2022
Unit: -	Data Type: UINT	Access Type: Read/Write

The following are the selections for the parameter.

Selection Number	Selection Name	Selection Description
0	Inactive	
1	Digital Output	Configures the terminal as boolean output true/false.
2	Pulse Output	Configures the terminal as analog output based on pulse frequency.
3	Digital input	The terminal is configured as boolean input (true/false).
4	Pulse input	The terminal is configured as pulse input. The frequency represents an analog value.

P 9.4.4.2 T15 Signal Inversion

Description: Select whether the signal of the terminal is inverted.

Default Value: 0 [Non-Inverted]	Parameter Type: Selection	Parameter Number: 2295
Unit: -	Data Type: UINT	Access Type: Read/Write

The following are the selections for the parameter.

Selection Number	Selection Name	Selection Description
0	Non-Inverted	The signal is not inverted.
1	Inverted	The signal is logically inverted.

P 9.4.4.3 T15 Fast Debounce Filtering Time

Description: Set the fast debounce filtering time for the terminal.

Default Value: 0.00	Parameter Type: Range (0.00 — 63.50)	Parameter Number: 2289
Unit: μ s	Data Type: REAL	Access Type: Read/Write

P 9.4.4.4 T15 Standard Debounce Filtering Time

Description: Set the standard debounce filtering time for the terminal.

Default Value: 5.00	Parameter Type: Range (0.00 — 127.00)	Parameter Number: 2297
Unit: ms	Data Type: REAL	Access Type: Read/Write

P 9.4.4.5 T15 Reaction Time

Description: Select the reaction time for the debounce filter.

Default Value: 0 [Standard reaction time (1ms tick)]	Parameter Type: Selection	Parameter Number: 2299
Unit: -	Data Type: UINT	Access Type: Read/Write

The following are the selections for the parameter.

Selection Number	Selection Name	Selection Description
0	Standard reaction time (1ms tick)	Use the digital input in the same way as other inputs.
1	Fast reaction time (0.5 μ s tick)	Enables fast reaction time for certain event via digital input.

P 9.4.4.6 T15 Trigger Mode

Description: Select the trigger mode for the digital input.

Default Value: 0 [None]	Parameter Type: Selection	Parameter Number: 2044
Unit: -	Data Type: UINT	Access Type: Read/Write

The following are the selections for the parameter.

Selection Number	Selection Name	Selection Description
0	None	No event trigger.
1	Rising Edge	Trig event at rising edge.
2	Falling Edge	Trig event at falling edge.
3	Both Edges	Trig event at both rising and falling edge.

P 9.4.4.7 T15 Pulse Min. Frequency

Description: Set the frequency representing 0% of the signal.

Default Value: 0	Parameter Type: Range (0 — 110000)	Parameter Number: 2045
Unit: Hz	Data Type: REAL	Access Type: Read/Write

P 9.4.4.8 T15 Pulse Max. Frequency

Description: Set the frequency representing 100% of the signal.

Default Value: 110000	Parameter Type: Range (0 — 110000)	Parameter Number: 2046
Unit: Hz	Data Type: REAL	Access Type: Read/Write

P 9.4.4.9 T15 Digital Output Logic

Description: Select the operating logic for the digital output.

Default Value: 0 [Tri state]	Parameter Type: Selection	Parameter Number: 2047
Unit: -	Data Type: UINT	Access Type: Read/Write

The following are the selections for the parameter.

Selection Number	Selection Name	Selection Description
0	Tri state	Disable output (high impedance).
1	Open collector sink (NPN)	Open collector sink (NPN).
2	Open collector source (PNP)	Open collector source (PNP).
3	Push pull	Terminal can both sink and source.

P 9.4.4.10 T15 Pulse Out Min. Frequency

Description: Set the frequency representing 0% of the signal.

Default Value: 0	Parameter Type: Range (0 — 100000)	Parameter Number: 2048
Unit: Hz	Data Type: REAL	Access Type: Read/Write

P 9.4.4.11 T15 Pulse Out Max. Frequency

Description: Set the frequency representing 100% of the signal.

Default Value: 100000	Parameter Type: Range (0 — 100000)	Parameter Number: 2049
Unit: Hz	Data Type: REAL	Access Type: Read/Write

6.10.2.3.6 Input/Output T16 (Menu Index 9.4.5)

P 9.4.5.1 T16 Terminal Mode

Description: Select the mode for the terminal.

Default Value: 3 [Digital input]	Parameter Type: Selection	Parameter Number: 2298
Unit: -	Data Type: UINT	Access Type: Read/Write

The following are the selections for the parameter.

Selection Number	Selection Name	Selection Description
0	Inactive	
1	Digital Output	Configures the terminal as boolean output true/false.
2	Pulse Output	Configures the terminal as analog output based on pulse frequency.
3	Digital input	The terminal is configured as boolean input (true/false).
4	Pulse input	The terminal is configured as pulse input. The frequency represents an analog value.

P 9.4.5.2 T16 Signal Inversion

Description: Select whether the signal of the terminal is inverted.

Default Value: 0 [Non-Inverted]	Parameter Type: Selection	Parameter Number: 2296
Unit: -	Data Type: UINT	Access Type: Read/Write

The following are the selections for the parameter.

Selection Number	Selection Name	Selection Description
0	Non-Inverted	The signal is not inverted.
1	Inverted	The signal is logically inverted.

P 9.4.5.3 T16 Fast Debounce Filtering Time

Description: Set the fast debounce filtering time for the terminal.

Default Value: 0.00	Parameter Type: Range (0.00 — 63.50)	Parameter Number: 2290
Unit: μ s	Data Type: REAL	Access Type: Read/Write

P 9.4.5.4 T16 Standard Debounce Filtering Time

Description: Set the standard debounce filtering time for the terminal.

Default Value: 5.00	Parameter Type: Range (0.00 — 127.00)	Parameter Number: 2260
Unit: ms	Data Type: REAL	Access Type: Read/Write

P 9.4.5.5 T16 Reaction Time

Description: Select the reaction time for the debounce filter.

Default Value: 0 [Standard reaction time (1ms tick)]	Parameter Type: Selection	Parameter Number: 2052
Unit: -	Data Type: UINT	Access Type: Read/Write

The following are the selections for the parameter.

Selection Number	Selection Name	Selection Description
0	Standard reaction time (1ms tick)	Use the digital input in the same way as other inputs.
1	Fast reaction time (0.5 μ s tick)	Enables fast reaction time for certain event via digital input.

P 9.4.5.6 T16 Trigger Mode

Description: Select the trigger mode for the digital input.

Default Value: 0 [None]	Parameter Type: Selection	Parameter Number: 2053
Unit: -	Data Type: UINT	Access Type: Read/Write

The following are the selections for the parameter.

Selection Number	Selection Name	Selection Description
0	None	No event trigger.
1	Rising Edge	Trig event at rising edge.
2	Falling Edge	Trig event at falling edge.
3	Both Edges	Trig event at both rising and falling edge.

P 9.4.5.7 T16 Pulse Min. Frequency

Description: Set the frequency representing 0% of the signal.

Default Value: 0	Parameter Type: Range (0 — 110000)	Parameter Number: 2054
Unit: Hz	Data Type: REAL	Access Type: Read/Write

P 9.4.5.8 T16 Pulse Max. Frequency

Description: Set the frequency representing 100% of the signal.

Default Value: 110000	Parameter Type: Range (0 — 110000)	Parameter Number: 2055
Unit: Hz	Data Type: REAL	Access Type: Read/Write

P 9.4.5.9 T16 Digital Output Type

Description: Select the operating logic for the digital output.

Default Value: 0 [Tri state]	Parameter Type: Selection	Parameter Number: 2056
Unit: -	Data Type: UINT	Access Type: Read/Write

The following are the selections for the parameter.

Selection Number	Selection Name	Selection Description
0	Tri state	Disable output (high impedance).
1	Open collector sink (NPN)	Open collector sink (NPN).
2	Open collector source (PNP)	Open collector source (PNP).
3	Push pull	Terminal can both sink and source.

P 9.4.5.10 T16 Pulse Out Min. Frequency

Description: Set the frequency representing 0% of the signal.

Default Value: 0	Parameter Type: Range (0 — 100000)	Parameter Number: 2051
Unit: Hz	Data Type: REAL	Access Type: Read/Write

P 9.4.5.11 T16 Pulse Out Max. Frequency

Description: Set the frequency representing 100% of the signal.

Default Value: 100000	Parameter Type: Range (0 — 100000)	Parameter Number: 2050
Unit: Hz	Data Type: REAL	Access Type: Read/Write

6.10.2.3.7 Input T17 (Menu Index 9.4.6)

P 9.4.6.1 T17 Terminal Mode

Description: Select the mode for the terminal.

Default Value: 3 [Digital input]	Parameter Type: Selection	Parameter Number: 2017
Unit: -	Data Type: UINT	Access Type: Read/Write

The following are the selections for the parameter.

Selection Number	Selection Name	Selection Description
0	Inactive	
3	Digital input	The terminal is configured as boolean input (true/false).
4	Pulse input	The terminal is configured as pulse input. The frequency represents an analog value.

P 9.4.6.2 T17 Signal Inversion

Description: Select whether the signal of the terminal is inverted.

Default Value: 0 [Non-Inverted]	Parameter Type: Selection	Parameter Number: 2293
Unit: -	Data Type: UINT	Access Type: Read/Write

The following are the selections for the parameter.

Selection Number	Selection Name	Selection Description
0	Non-Inverted	The signal is not inverted.
1	Inverted	The signal is logically inverted.

P 9.4.6.3 T17 Fast Debounce Filtering Time

Description: Set the fast debounce filtering time for the terminal.

Default Value: 0.00	Parameter Type: Range (0.00 — 63.50)	Parameter Number: 2287
Unit: μ s	Data Type: REAL	Access Type: Read/Write

P 9.4.6.4 T17 Standard Debounce Filtering Time

Description: Set the standard debounce filtering time for the terminal.

Default Value: 5.00	Parameter Type: Range (0.00 — 127.00)	Parameter Number: 2034
Unit: ms	Data Type: REAL	Access Type: Read/Write

P 9.4.6.5 T17 Reaction Time

Description: Select the reaction time for the debounce filter.

Default Value: 0 [Standard reaction time (1ms tick)]	Parameter Type: Selection	Parameter Number: 2035
Unit: -	Data Type: UINT	Access Type: Read/Write

The following are the selections for the parameter.

Selection Number	Selection Name	Selection Description
0	Standard reaction time (1ms tick)	Use the digital input in the same way as other inputs.
1	Fast reaction time (0.5 μ s tick)	Enables fast reaction time for certain event via digital input.

P 9.4.6.6 T17 Trigger Mode

Description: Select the trigger mode for the digital input.

Default Value: 0 [None]	Parameter Type: Selection	Parameter Number: 2036
Unit: -	Data Type: UINT	Access Type: Read/Write

The following are the selections for the parameter.

Selection Number	Selection Name	Selection Description
0	None	No event trigger.
1	Rising Edge	Trig event at rising edge.
2	Falling Edge	Trig event at falling edge.
3	Both Edges	Trig event at both rising and falling edge.

P 9.4.6.7 T17 Pulse Min. Frequency

Description: Set the frequency representing 0% of the signal.

Default Value: 0	Parameter Type: Range (0 — 110000)	Parameter Number: 2037
Unit: Hz	Data Type: REAL	Access Type: Read/Write

P 9.4.6.8 T17 Pulse Max. Frequency

Description: Set the frequency representing 100% of the signal.

Default Value: 110000	Parameter Type: Range (0 — 110000)	Parameter Number: 2038
Unit: Hz	Data Type: REAL	Access Type: Read/Write

6.10.2.3.8 Input T18 (Menu Index 9.4.7)

P 9.4.7.1 T18 Terminal Mode

Description: Select the mode for the terminal.

Default Value: 3 [Digital input]	Parameter Type: Selection	Parameter Number: 2018
Unit: -	Data Type: UINT	Access Type: Read/Write

The following are the selections for the parameter.

Selection Number	Selection Name	Selection Description
0	Inactive	
3	Digital input	The terminal is configured as boolean input (true/false).
4	Pulse input	The terminal is configured as pulse input. The frequency represents an analog value.

P 9.4.7.2 T18 Signal Inversion

Description: Select whether the signal of the terminal is inverted.

Default Value: 0 [Non-Inverted]	Parameter Type: Selection	Parameter Number: 2294
Unit: -	Data Type: UINT	Access Type: Read/Write

The following are the selections for the parameter.

Selection Number	Selection Name	Selection Description
0	Non-Inverted	The signal is not inverted.
1	Inverted	The signal is logically inverted.

P 9.4.7.3 T18 Fast Debounce Filtering Time

Description: Set the fast debounce filtering time for the terminal.

Default Value: 0.00	Parameter Type: Range (0.00 — 63.50)	Parameter Number: 2288
Unit: μ s	Data Type: REAL	Access Type: Read/Write

P 9.4.7.4 T18 Standard Debounce Filtering Time

Description: Set the standard debounce filtering time for the terminal.

Default Value: 5.00	Parameter Type: Range (0.00 — 127.00)	Parameter Number: 2039
Unit: ms	Data Type: REAL	Access Type: Read/Write

P 9.4.7.5 T18 Reaction Time

Description: Select the reaction time for the debounce filter.

Default Value: 0 [Standard reaction time (1ms tick)]	Parameter Type: Selection	Parameter Number: 2040
Unit: -	Data Type: UINT	Access Type: Read/Write

The following are the selections for the parameter.

Selection Number	Selection Name	Selection Description
0	Standard reaction time (1ms tick)	Use the digital input in the same way as other inputs.
1	Fast reaction time (0.5μs tick)	Enables fast reaction time for certain event via digital input.

P 9.4.7.6 T18 Trigger Mode

Description: Select the trigger mode for the digital input.

Default Value: 0 [None]	Parameter Type: Selection	Parameter Number: 2041
Unit: -	Data Type: UINT	Access Type: Read/Write

The following are the selections for the parameter.

Selection Number	Selection Name	Selection Description
0	None	No event trigger.
1	Rising Edge	Trig event at rising edge.
2	Falling Edge	Trig event at falling edge.
3	Both Edges	Trig event at both rising and falling edge.

P 9.4.7.7 T18 Pulse Min. Frequency

Description: Set the frequency representing 0% of the signal.

Default Value: 0	Parameter Type: Range (0 — 110000)	Parameter Number: 2042
Unit: Hz	Data Type: REAL	Access Type: Read/Write

P 9.4.7.8 T18 Pulse Max. Frequency

Description: Set the frequency representing 100% of the signal.

Default Value: 110000	Parameter Type: Range (0 — 110000)	Parameter Number: 2043
Unit: Hz	Data Type: REAL	Access Type: Read/Write

6.10.2.4 Analog Inputs/Outputs (Menu Index 9.5)

6.10.2.4.1 Output T31 (Menu Index 9.5.1)

P 9.5.1.1 T31 Terminal Mode

Description: Select the mode for the terminal.

Default Value: 5 [Analog Output]	Parameter Type: Selection	Parameter Number: 2019
Unit: -	Data Type: UINT	Access Type: Read/Write

The following are the selections for the parameter.

Selection Number	Selection Name	Selection Description
0	Inactive	
5	Analog Output	Configures the terminal as analog output.

P 9.5.1.2 T31 Terminal Type

Description: Select the type of the terminal. If voltage is selected, the unit is V. If current is selected, the unit is mA.

Default Value: 0 [Off]	Parameter Type: Selection	Parameter Number: 2284
Unit: -	Data Type: UINT	Access Type: Read/Write

The following are the selections for the parameter.

Selection Number	Selection Name	Selection Description
0	Off	
1	Voltage	Terminal set to voltage mode.
2	Current	Terminal set to current mode.

P 9.5.1.3 T31 Minimum Value

Description: Set the voltage or current representing 0% of the signal.

Default Value: 0.0	Parameter Type: Range (0 — 20.0)	Parameter Number: 2283
Unit: -	Data Type: REAL	Access Type: Read/Write

P 9.5.1.4 T31 Maximum Value

Description: Set the voltage or current representing 100% of the signal.

Default Value: 10.0	Parameter Type: Range (0 — 20.0)	Parameter Number: 2282
Unit: -	Data Type: REAL	Access Type: Read/Write

6.10.2.4.2 Input T33 (Menu Index 9.5.2)

P 9.5.2.1 T33 Terminal Mode

Description: Select the mode for the terminal.

Default Value: 6 [Analog Input]	Parameter Type: Selection	Parameter Number: 2020
Unit: -	Data Type: UINT	Access Type: Read/Write

The following are the selections for the parameter.

Selection Number	Selection Name	Selection Description
0	Inactive	
6	Analog Input	Configures the terminal as analog input.

P 9.5.2.2 T33 Terminal Type

Description: Select the type of the terminal. If voltage is selected, the unit is V. If current is selected, the unit is mA.

Default Value: 1 [Voltage]	Parameter Type: Selection	Parameter Number: 2273
Unit: -	Data Type: UINT	Access Type: Read/Write

The following are the selections for the parameter.

Selection Number	Selection Name	Selection Description
1	Voltage	Terminal set to voltage mode.
2	Current	Terminal set to current mode.

P 9.5.2.3 T33 Minimum Value

Description: Set the voltage or current representing 0% of the signal.

Default Value: 0	Parameter Type: Range (-20 — 20)	Parameter Number: 2272
Unit: -	Data Type: REAL	Access Type: Read/Write

P 9.5.2.4 T33 Maximum Value

Description: Set the voltage or current representing 100% of the signal.

Default Value: 10	Parameter Type: Range (-20 — 20)	Parameter Number: 2271
Unit: -	Data Type: REAL	Access Type: Read/Write

P 9.5.2.5 T33 Filter Time

Description: Set the filter time for the terminal.

Default Value: 0.00	Parameter Type: Range (0.00 — 60000.00)	Parameter Number: 2270
Unit: ms	Data Type: REAL	Access Type: Read/Write

P 9.5.2.6 T33 Live Zero Threshold Value

Description: Set the live zero threshold value for the terminal. The response to a live zero event is defined with parameter "5.2.15.2 Live Zero Response".

Default Value: -10	Parameter Type: Range (-20 — 20)	Parameter Number: 2274
Unit: -	Data Type: REAL	Access Type: Read/Write

P 9.5.2.7 T33 Live Zero Timeout Value

Description: Set the live zero timeout value for the terminal. The response to a live zero event is defined with parameter "5.2.15.2 Live Zero Response".

Default Value: 0.0	Parameter Type: Range (0.0 — 60.0)	Parameter Number: 2275
Unit: s	Data Type: REAL	Access Type: Read/Write

6.10.2.4.3 Input T34 (Menu Index 9.5.3)

P 9.5.3.1 T34 Terminal Mode

Description: Select the mode for the terminal.

Default Value: 6 [Analog Input]	Parameter Type: Selection	Parameter Number: 2021
Unit: -	Data Type: UINT	Access Type: Read/Write

The following are the selections for the parameter.

Selection Number	Selection Name	Selection Description
0	Inactive	
6	Analog Input	Configures the terminal as analog input.
7	Temperature input	Configures the terminal as temperature sensor input.

P 9.5.3.2 T34 Terminal Type

Description: Select the type of the terminal. If voltage is selected, the unit is V. If current is selected, the unit is mA.

Default Value: 1 [Voltage]	Parameter Type: Selection	Parameter Number: 2279
Unit: -	Data Type: UINT	Access Type: Read/Write

The following are the selections for the parameter.

Selection Number	Selection Name	Selection Description
1	Voltage	Terminal set to voltage mode.
2	Current	Terminal set to current mode.

P 9.5.3.3 T34 Minimum Value

Description: Set the voltage or current representing 0% of the signal.

Default Value: 0	Parameter Type: Range (-20 — 20)	Parameter Number: 2278
Unit: -	Data Type: REAL	Access Type: Read/Write

P 9.5.3.4 T34 Maximum Value

Description: Set the voltage or current representing 100% of the signal.

Default Value: 10	Parameter Type: Range (-20 — 20)	Parameter Number: 2277
Unit: -	Data Type: REAL	Access Type: Read/Write

P 9.5.3.5 T34 Filter Time

Description: Set the filter time for the terminal.

Default Value: 0.00	Parameter Type: Range (0.00 — 60000.00)	Parameter Number: 2276
Unit: ms	Data Type: REAL	Access Type: Read/Write

P 9.5.3.6 T34 Live Zero Threshold Value

Description: Set the live zero threshold value for the terminal. The response to a live zero event is defined with parameter "5.2.15.2 Live Zero Response".

Default Value: -10	Parameter Type: Range (-20 — 20)	Parameter Number: 2280
Unit: -	Data Type: REAL	Access Type: Read/Write

P 9.5.3.7 T34 Live Zero Timeout Value

Description: Set the live zero timeout value for the terminal. The response to a live zero event is defined with parameter "5.2.15.2 Live Zero Response".

Default Value: 0.0	Parameter Type: Range (0.0 — 60.0)	Parameter Number: 2281
Unit: s	Data Type: REAL	Access Type: Read/Write

P 9.5.3.8 T34 Temperature Sensor Type

Description: Select which type of temperature sensor is connected to the terminal.

Default Value: 0 [No sensor]	Parameter Type: Selection	Parameter Number: 1617
Unit: -	Data Type: UINT	Access Type: Read/Write

The following are the selections for the parameter.

Selection Number	Selection Name	Selection Description
0	No sensor	No sensor selected.
4	Pt1000	Pt1000 temperature sensor connected.
5	Ni1000Tk5000	Ni1000Tk5000 temperature sensor connected.
6	Ni1000Tk6180	Ni1000Tk6180 temperature sensor connected.
7	KTY84-1x0	KTY84-1x0 temperature sensor connected.
8	KTY84-151	KTY84-151 temperature sensor connected.
9	KTY84-152	KTY84-152 temperature sensor connected.
10	KTY81/82-1x0	KTY81/82-1x0 temperature sensor connected.
11	KTY81/82-121	KTY81/82-121 temperature sensor connected.
12	KTY81/82-122	KTY81/82-122 temperature sensor connected.
13	KTY81/82-151	KTY81/82-151 temperature sensor connected.
14	KTY81/82-152	KTY81/82-152 temperature sensor connected.
15	KTY81/82-2x0	KTY81/82-2x0 temperature sensor connected.
16	KTY81/82-221	KTY81/82-221 temperature sensor connected.
17	KTY81/82-222	KTY81/82-222 temperature sensor connected.
18	KTY81/82-251	KTY81/82-251 temperature sensor connected.
19	KTY81/82-252	KTY81/82-252 temperature sensor connected.

6.11 Connectivity (Menu Index 10)

6.11.1 Connectivity Overview

This section provides information about configuring and monitoring all types of communication interfaces as well as the communication and fieldbus protocols available. Following are the available interfaces:

- Communication interface X0
- Communication interface X1/X2

The following are the available network management protocol and fieldbus protocols:

- SNMP
- PROFINET
- MODBUS TCP
- EtherNet/IP

For more information, refer to the related fieldbus guide.

6.11.2 Communication interfaces (Menu Index 10.2)

6.11.2.1 Host Settings (Menu Index 10.2.1)

P 10.2.1.1 Fully Qualified Domain Name

Description: Fully Qualified Domain Name. Consists of a host name label and at least 1 higher-level domain separated by the symbol "." with up to 240 characters in total. Each label contains upto 63 characters and starts with a lowercase letter and ends with alphanumeric lowercase character and have as interior characters only alphanumeric lowercase characters and '-'.
 Note: The domain name must be unique.

Default Value: *	Parameter Type: Range (* — *)	Parameter Number: 7036
Unit: -	Data Type: STRING	Access Type: Read/Write

6.11.2.2 Ethernet Interface X0 (Menu Index 10.2.2)

6.11.2.2.1 Interface X0 IPv4 Settings

The Ethernet Interface X0 IPv4 settings view contains the following fields:

- Interface X0 MAC address
- IPv4 addressing method
- Requested IPv4 address
- Requested IPv4 SUBNET mask
- Requested IPv4 gateway address
- Enable ACD
- DNS server 1
- DNS server 2

6.11.2.2.2 Interface X0 IPv4 Status

The Ethernet Interface X0 IPv4 status view contains the following fields:

- Interface X0 MAC address
- IPv4 addressing method
- Actual IPv4 address
- Actual IPv4 SUBNET mask
- Actual IPv4 gateway address
- DHCP server
- Actual DNS server 1
- Actual DNS server 2
- ACD activity

6.11.2.3 Ethernet Interface X1/X2 Settings (Menu Index 10.2.3)

6.11.2.3.1 Interface X1/X2 IPv4 Settings

The Ethernet Interface X1/X2 IPv4 settings view contains the following fields:

- Interface X1 MAC address
- IPv4 addressing method
- Requested IPv4 address
- Requested IPv4 SUBNET mask
- Requested IPv4 gateway address
- Enable ACD
- DNS server 1
- DNS server 2

6.11.2.3.2 Interface X1/X2 IPv4 Status

The Ethernet Interface X1/X2 IPv4 status view contains the following fields:

- Interface X1 MAC address
- IPv4 addressing method
- Actual IPv4 address
- Actual IPv4 SUBNET mask
- Actual IPv4 gateway address
- DHCP server
- Actual DNS server 1
- Actual DNS server 2
- ACD activity

6.11.2.4 Ethernet port X0 (Menu Index 10.2.4)

6.11.2.4.1 X0 Settings (Menu Index 10.2.4.2)

P 10.2.4.2.5 Link configuration X0

Description: Select the configuration of the Ethernet link parameters.

Default Value: 0 [Auto negotiation]	Parameter Type: Selection	Parameter Number: 7047
Unit: -	Data Type: USINT	Access Type: Read/Write

The following are the selections for the parameter.

Selection Number	Selection Name	Selection Description
0	Auto negotiation	The drive handles the speed and duplex settings.
1	10 Mbps full duplex	10 Mbps with full duplex.
2	10 Mbps half duplex	10 Mbps with half duplex.
3	100 Mbps full duplex	100 Mbps with full duplex.
4	100 Mbps half duplex	100 Mbps with half duplex.

6.11.2.5 Ethernet port X1 (Menu Index 10.2.5)

6.11.2.5.1 X1 Settings (Menu Index 10.2.5.2)

P 10.2.5.2.5 Link Configuration X1

Description: Select the configuration of the Ethernet link parameters.

Default Value: 0 [Auto negotiation]	Parameter Type: Selection	Parameter Number: 7048
Unit: -	Data Type: USINT	Access Type: Read/Write

The following are the selections for the parameter.

Selection Number	Selection Name	Selection Description
0	Auto negotiation	The drive handles the speed and duplex settings.
1	10 Mbps full duplex	10 Mbps with full duplex.
2	10 Mbps half duplex	10 Mbps with half duplex.
3	100 Mbps full duplex	100 Mbps with full duplex.
4	100 Mbps half duplex	100 Mbps with half duplex.

6.11.2.6 Ethernet port X2 (Menu Index 10.2.6)

6.11.2.6.1 X2 Settings (Menu Index 10.2.6.2)

P 10.2.6.2.5 Link Configuration X2

Description: Select the configuration of the Ethernet link parameters.

Default Value: 0 [Auto negotiation]	Parameter Type: Selection	Parameter Number: 7049
Unit: -	Data Type: USINT	Access Type: Read/Write

The following are the selections for the parameter.

Selection Number	Selection Name	Selection Description
0	Auto negotiation	The drive handles the speed and duplex settings.
1	10 Mbps full duplex	10 Mbps with full duplex.
2	10 Mbps half duplex	10 Mbps with half duplex.
3	100 Mbps full duplex	100 Mbps with full duplex.
4	100 Mbps half duplex	100 Mbps with half duplex.

6.11.3 Protocols (Menu Index 10.3)

6.11.3.1 General Settings (Menu Index 10.3.1)

P 10.3.1.2 Fieldbus Profile

Description: Select the fieldbus profile. The selection affects the interpretation of the control word and status word.

Default Value: 101 [iC Speed Profile]	Parameter Type: Selection	Parameter Number: 1301
Unit: -	Data Type: UINT	Access Type: Read/Write

The following are the selections for the parameter.

Selection Number	Selection Name	Selection Description
101	iC Speed Profile	The fieldbus control word and status word are interpreted according to the iC Speed Profile definition.
201	PROFIdrive Standard Telegram 1	The fieldbus control word and status word are interpreted according to the PROFIdrive Standard Telegram 1 standard.

P 10.3.1.3 Fieldbus Fault Response

Description: Select the behavior when a fieldbus fault occurs.

Default Value: 1 [Info]	Parameter Type: Selection	Parameter Number: 1303
Unit: -	Data Type: UINT	Access Type: Read/Write

The following are the selections for the parameter.

Selection Number	Selection Name	Selection Description
1	Info	The event is logged in the event log.
3	Warning	The drive issues a warning.
9	Fault, ramp to coast	Issues a fault, ramps down, and coast.
10	Fault	The drive issues a fault and coasts the motor.

P 10.3.1.4 No Fieldbus Connection Response

Description: Select the response in case there is no fieldbus connection.

Default Value: 1 [Info]	Parameter Type: Selection	Parameter Number: 1327
Unit: -	Data Type: UINT	Access Type: Read/Write

The following are the selections for the parameter.

Selection Number	Selection Name	Selection Description
1	Info	The event is logged in the event log.
3	Warning	The drive issues a warning.
9	Fault, ramp to coast	Issues a fault, ramps down, and coast.
10	Fault	The drive issues a fault and coasts the motor.

P 10.3.1.6 Process Data Timeout Time

Description: Set the timeout time. If process data is not received within the time set, a process data timeout is triggered.

Default Value: 1	Parameter Type: Range (0 — 18000)	Parameter Number: 1340
Unit: s	Data Type: REAL	Access Type: Read/Write

P 10.3.1.12 Process Data Timeout Response

Description: Select the response to a process data timeout.

Default Value: 10 [Fault]	Parameter Type: Selection	Parameter Number: 1341
Unit: -	Data Type: UINT	Access Type: Read/Write

The following are the selections for the parameter.

Selection Number	Selection Name	Selection Description
1	Info	The event is logged in the event log.
3	Warning	The drive issues a warning.
5	Warning - Change Control Place	The drive issues a warning, and the control place changes to the selected alternative while the timeout warning is active. The control place will change back to the original one when the fieldbus process data returns.
6	Warning - Change Control Place - Persistent	The drive issues a warning, and the control place changes to the selected alternative while the timeout warning is active. The control place requires a reset command to change back to the original one after the fieldbus process data returns.
9	Fault, ramp to coast	Issues a fault, ramps down, and coast.
10	Fault	The drive issues a fault and coasts the motor.

P 10.3.1.13 Process Data Timeout Control Place

Description: Select the alternative control place to be used in case of fieldbus timeout. This is only valid in case of timeout warning or info.

Default Value: 1 [Local control]	Parameter Type: Selection	Parameter Number: 112
Unit: -	Data Type: UINT	Access Type: Read/Write

The following are the selections for the parameter.

Selection Number	Selection Name	Selection Description
1	Local control	The drive is controlled by a connected control panel.
2	Fieldbus control	The drive is controlled via a fieldbus.
3	I/O control	The drive is controlled via I/O.
4	Advanced control	The drive is controlled via a combination of I/O and fieldbus.

6.11.3.2 PROFINET (Menu Index 10.3.2)

6.11.3.2.1 Configuration (Menu Index 10.3.2.2)

P 10.3.2.2.1 Name of Station

Description: Set the name of station. The PROFINET device is identified by its name of station. Each name must be unique in the network.

Default Value:	Parameter Type: Range (* — *)	Parameter Number: 7080
Unit: -	Data Type: STRING	Access Type: Read/Write

6.11.3.2.2 Diagnosis (Menu Index 10.3.2.3)

P 10.3.2.3.1 Diagnostic Fault

Description: Enables diagnostic fault. When disabled the device will not send any PROFINET diagnosis message with severity "Fault" when a fault is present on device.

Default Value: 1 [Enabled]	Parameter Type: Selection	Parameter Number: 7081
Unit: -	Data Type: BOOL	Access Type: Read/Write

The following are the selections for the parameter.

Selection Number	Selection Name	Selection Description
0	Disabled	Disables the function.
1	Enabled	Enables the function.

P 10.3.2.3.2 Diagnostic Warning

Description: Enables diagnostic warning. When disabled the device will not send any PROFINET diagnosis message with severity "Maintenance required" when a warning is present on device.

Default Value: 1 [Enabled]	Parameter Type: Selection	Parameter Number: 7083
Unit: -	Data Type: BOOL	Access Type: Read/Write

The following are the selections for the parameter.

Selection Number	Selection Name	Selection Description
0	Disabled	Disables the function.
1	Enabled	Enables the function.

6.11.3.3 Modbus TCP (Menu Index 10.3.3)

6.11.3.3.1 Configuration (Menu Index 10.3.3.2)

P 10.3.3.2.1 Persistent Storage

Description: Select if persistent storage is active for Modbus writes.

Default Value: 0 [Disabled]	Parameter Type: Selection	Parameter Number: 7061
Unit: -	Data Type: BOOL	Access Type: Read/Write

The following are the selections for the parameter.

Selection Number	Selection Name	Selection Description
0	Disabled	Modbus writings are not written to persistent storage.
1	Enabled	Modbus writings are written to persistent storage.

P 10.3.3.2.3 Byte Order

Description: Select the byte order.

Default Value: 0 [Big Endian]	Parameter Type: Selection	Parameter Number: 7062
Unit: -	Data Type: USINT	Access Type: Read/Write

The following are the selections for the parameter.

Selection Number	Selection Name	Selection Description
0	Big Endian	Byte order is defined as big-endian - The most significant value to the left.
1	Little Endian	Byte order is defined as little-endian - The least significant value to the left.

P 10.3.3.2.4 Word Order

Description: Select the word order.

Default Value: 1 [Little Endian]	Parameter Type: Selection	Parameter Number: 7063
Unit: -	Data Type: USINT	Access Type: Read/Write

The following are the selections for the parameter.

Selection Number	Selection Name	Selection Description
0	Big Endian	Byte order is defined as big-endian - The most significant value to the left.
1	Little Endian	Byte order is defined as little-endian - The least significant value to the left.

7 Troubleshooting

7.1 Viewing Warnings

When a warning event occurs, the status indicators (halo and WARN) turn yellow. The drive remains operational and when the trigger for the warning is corrected, the indicators turn white.

To view the details of a warning, go to parameter group **6.4.1 Active Events**.

To view the history of events for the drive, go to parameter group **6.4.2 Event History**.



Figure 76: Warnings

7.2 Viewing and Resetting Faults

When a fault occurs in the drive, the status indicators halo and FAULT turn red. The control panel display shows the name of the fault, and allows a direct reset.

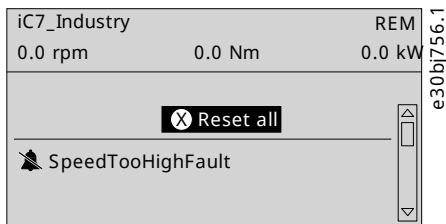

Figure 77: Fault on the Control Panel

1. To view details about a fault and its cause, select the fault in the list shown on the control panel and press [OK].

If the control panel display has changed, simultaneously press the left and right arrows on the control panel to return to parameter group **6.4.1 Active Events**.

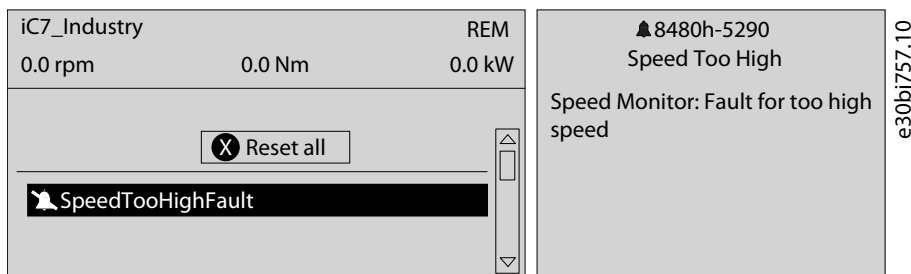

Figure 78: View Active Faults

2. Resolve all triggers causing the fault.
3. Select *Reset all* and press [OK].

7.3 Reading the Event Summary Table

Group number and number (columns 1–2)

Events in iC7 drives have 2 different identifiers: Group numbers and Individual numbers.

The group numbers for iC7 drives follow the DRIVECOM industry standard error code specification. The specification originated with the Interbus communication profile. The [Interbus V3.0 base profile](#) was released on 2018-04-19. The [inverter specific profile](#) was released on 1997-12-15. The error code specification was adopted by CAN in Automation and ODVA and is used within their respective Drive Profile. The list of standardized error codes can be found within [IEC 61800-7-201](#).

Unlike individual numbers, the group numbers are not unique since multiple errors can be related to each other. An example is different ground faults which share the Group Number 0x2330.

Display name and description (columns 3–4)

The columns are showing the name and a short description of the event. A few display names are marked with a * which indicates that the event can be configured via a parameter.

Type of event (columns 5–8)

The event summary table shows column names where I – Info, W – Warning, F – Fault, and PF – Protected Fault.

- **Info:** The notification provides information to the user.
- **Warning:** The notification informs that an undesired event is happening. The drive can continue operation, but it might be with reduced performance and/or the drive might trip.
- **Fault (Trip):** An error notification informs that an undesired high-severity event occurred. The motor coasts without control from the drive. The error message and the error can be reset without power cycling the drive.
- **Protected Fault (Trip Lock):** An error notification informs that an undesired high-severity event happened. The motor coasts without control from the drive. The error message and the error can be reset after power cycling the drive.

Action of the inverter and brake chopper (columns 9–10)

The columns show the possible action of the inverter (output of the drive) and the brake chopper, where C = Coast and RC = Ramp to Coast.

- **Inverter:**
 - RC: Output ramps to 0 before coasting.
 - C: Output coasts immediately.
- **Brake chopper:**
 - C: Output of the brake coasts immediately.

7.4 Events Summary for Industry Application Software

The following table lists the events that can occur in the Industry application software.

Table 40: Summary Table

Group Number (Hex)	Number (Decimal)	Display Name	Description	Type of Event				Inverter and Brake Chopper Action	
				I	W	F	P	Inverter	Brake
0x20FF	4372	Current Injection Limit	The time limit for the short term current injection has been exceeded.		X	X		C	
0x2110	4379	CM Current High	An excessive common mode current has been detected in the LCL-filter.		X	X		C	
0x2212	4374	DC-link Resonance	A resonance on the DC link with excessive RMS current values has been detected.		X	X		C	
0x2221	4384	Thermal Overload Rectifier	The rectifier is thermally overloaded. Mission profile is too demanding.		X	X		C	
0x2222	4373	DC-link Overcurrent	An overcurrent on the main DC-link capacitors has been detected.		X	X		C	
0x2310	5170	Current Limit Timeout	The drive has exceeded the allowed time in current limit.			X		C	
0x2311	4097	Inverter Overload	Thermal overload is detected in the inverter of the drive. Reduce the output load.		X	X		C	
0x2311	4368	Output Current High 0	The output current of the drive has exceeded its normal range at low speed. Shock load or too fast acceleration with high-inertia loads can cause this fault. Check that the motor size matches the drive and the motor data is correct. Check that the motor shaft can be turned.		X	X		C	
0x2311	4369	Output Current High 1	The output current of the drive has exceeded its normal range. Shock load or too fast acceleration with high-inertia loads can cause this fault. Check that the motor size matches the drive and the motor data is correct. Check that the motor shaft can be turned.		X	X		C	
0x2311	4375	Excessive Current Limiting	The output current of the drive has exceeded the current limit multiple times. Check that the motor size matches the drive and the motor data is correct. Check that the motor shaft can be turned.		X	X		C	
0x2311	4377	Smart Derating Fault	A Smart Derating fault is detected. The load is too demanding for the current derating level. Lower the switching frequency if possible.		X	X		C	

Table 40: Summary Table (continued)

Group Number (Hex)	Number (Decimal)	Display Name	Description	Type of Event			Inverter and Brake Chopper Action	
				I	F	P	Inverter	Brake
0x2311	4380	Current Limit Setting Fault	The actual current limit setting is too high relative to the selected constant control frequency level. Reduce the control frequency setting or reduce the current limit setting.		X		C	C
0x2330	4352	Ground Fault 0	A high-impedance ground fault is detected on the output. Check the insulation of motor cable and motor.	X	X		C	
0x2330	4353	Ground Fault 1	A high-impedance ground fault is detected on the output. Check the insulation of motor cable and motor.	X	X		C	
0x2330	4354	Ground Fault 2	A low-impedance ground fault is detected on the output. Check the insulation of motor cable and motor.	X		X	C	
0x2330	4355	Ground Fault 21	A high or low-impedance ground fault is detected on the output. Check the insulation of motor cable and motor.	X		X	C	
0x2340	4356	Inverter Short Circuit	A short circuit at the inverter output is detected. Check the motor and motor cable.	X		X	C	
0x2340	4370	Output Current High 2	A critical output overcurrent has been detected. Check for short circuits on the output.	X		X	C	
0x2340	4649	Desat Gate Driver	The gate driver has detected desaturation condition.		X		C	C
0x23FE	4371	Current Imbalance	A current imbalance between paralleled power units has been detected.	X				
0x23FF	4175	Motor Disconnected	The motor is disconnected.	X	X		C	
0x23FF	4176	Missing Motor Phase	A missing motor phase is detected. Check motor, motor cables, and connections.	X	X		C	
0x3110	4162	Grid Voltage Spikes	Excessive spikes on the grid voltage have been detected.	X	X		C	
0x3110	4164	Grid Voltage High	Grid voltage (RMS) above the normal operating range is detected.	X	X		C	C
0x3120	4165	Grid Voltage Low	A grid voltage (RMS) below the normal operating range is detected.	X	X		C	

Table 40: Summary Table (continued)

Group Number (Hex)	Number (Decimal)	Display Name	Description	Type of Event				Inverter and Brake Chopper Action	
				I	W	F	P	Inverter	Brake
0x3130	4160	Missing Grid Phase	A missing phase is detected on the grid side. Check the grid supply, cables, connections, and fuses.		X	X		C	
0x3130	4163	Grid Imbalance	A large imbalance of the grid voltages is detected. Check for uneven loads on the grid.		X	X		C	
0x3140	4161	Grid Frequency Out of Range	A grid frequency outside the normal operating range is detected.		X	X		C	
0x3140	4166	Grid Synchronization Error	The drive is unable to maintain the synchronization to the grid voltage.		X	X		C	
0x3211	4144	DC-link Voltage High 2	The voltage of the DC link is above the normal operating range. Can be caused by too fast motor braking or grid transients. Increase deceleration time, enable the overvoltage controller, use AC brake, or use a brake resistor while braking.		X	X		C	C
0x3212	4145	DC-link Voltage High 1	The voltage of the DC link is above the normal operating range and has reached a critical level. Can be caused by too fast motor braking or grid transients. Increase deceleration time, enable the overvoltage controller, use AC brake, or use a brake resistor while braking.		X	X		C	
0x3221	4146	DC-link Voltage Low	The DC-link voltage is below the normal operating range. Try to enable undervoltage protection to keep the drive running as long as possible.		X	X		C	C
0x32FF	4147	DC-link Voltage Ripple	Excessive voltage ripple has been detected on the main DC-link capacitors. This can be caused by an imbalance of the grid. Reduce the output power.		X	X		C	
0x32FF	4148	DC-link Imbalance	An imbalance across the DC-link capacitors is detected. The imbalance can be caused by a component fault of the DC link. If the fault remains after resetting the drive, service is required.		X	X		C	

Table 40: Summary Table (continued)

Group Number (Hex)	Number (Decimal)	Display Name	Description	Type of Event			Inverter and Brake Chopper Action	
				I	F	P	Inverter	Brake
0x4110	4099	Ambient Temp. High	The ambient temperature is too high. Check the temperature and cooling conditions. Lower the temperature or improve the cooling conditions.	X				
0x4210	4107	Brake Chopper Temp. Limit	The temperature of the brake chopper heat sink is at the upper limit of the normal temperature range. Check cooling and heat sink conditions. Reduce the generated regenerative power.	X				
0x4210	4108	Brake Chopper Temp. High 1	The temperature of the brake chopper heat sink has exceeded the normal temperature range. Check cooling and heat sink conditions. Reduce the generated regenerative power.	X	X		C	C
0x4210	4109	Brake Chopper Temp. High 2	The temperature of the brake chopper heat sink has reached a critical level. Check cooling and heat sink conditions. Reduce the generated regenerative power.	X	X		C	C
0x4220	4106	Brake Chopper Temp. Low	The temperature of the brake chopper heat sink is too low. Check the ambient temperature. Increase the ambient temperature or consider an external heater to increase the temperature around the drive.	X	X		C	C
0x4280	5132	Temp. Protection 1	Temperature protection 1 is triggered. The temperature has exceeded the configured value.	X	X		RC	
0x4280	5133	Temp. Protection 2	Temperature protection 2 is triggered. The temperature has exceeded the configured value.	X	X		RC	
0x4280	5134	Temp. Protection 3	Temperature protection 3 is triggered. The temperature has exceeded the configured value.	X	X		RC	
0x4280	5135	Temp. Protection 4	Temperature protection 4 is triggered. The temperature has exceeded the configured value.	X	X		RC	

Table 40: Summary Table (continued)

Group Number (Hex)	Number (Decimal)	Display Name	Description	Type of Event				Inverter and Brake Chopper Action	
				I	W	F	P	Inverter	Brake
0x4280	5136	Temp. Protection 5	Temperature protection 5 is triggered. The temperature has exceeded the configured value.		X	X		RC	
0x4280	5137	Temp. Protection 6	Temperature protection 6 is triggered. The temperature has exceeded the configured value.		X	X		RC	
0x4280	5158	Motor Temperature	The analog temperature sensor has exceeded the configured value.		X	X		RC	C
0x4281	5157	Motor Thermistor	The motor thermistor is too hot.			X		C	
0x42FF	4200	Power Option Temp. High 1	The temperature of a power option has exceeded the normal temperature range. Check the cooling conditions. Reduce the load or the ambient temperature.		X	X		RC	C
0x42FF	4201	Power Option Temp. High 2	The temperature of a power option has reached a critical level. Check the cooling conditions. Reduce the load or the ambient temperature.		X	X		RC	C
0x42FF	4202	Power Option Temp. Low	The temperature of a power option component is too low. Check the ambient temperature. Increase the ambient temperature or consider an external heater to increase the temperature around the power option.		X	X		RC	C
0x42FF	4203	Power Option Temp. Limit	The temperature of a power option component is at the upper limit of the normal temperature. Check the cooling conditions. Reduce the load or the ambient temperature.		X				
0x42FF	4204	Power Option Temp. Imbal. 1	The thermal imbalance between the power option components exceeds the normal operating range.		X	X		RC	C
0x42FF	4205	Power Option Temp. Imbal. 2	An excessive thermal imbalance between power option components has been detected.		X	X		RC	C
0x42FF	4206	Power Option Temp. Imbal. Limit	The thermal imbalance between the power option components is at the upper limit of the normal operating range.		X				

Table 40: Summary Table (continued)

Group Number (Hex)	Number (Decimal)	Display Name	Description	Type of Event				Inverter and Brake Chopper Action	
				I	W	F	P	Inverter	Brake
0x4310	4103	Inverter Temp. Limit	The temperature of the inverter heat sink is at the upper limit of the normal temperature range. Check cooling and heat sink conditions. Reduce the output current or ambient temperature. The drive may derate if the temperature is not lowered.		X				
0x4310	4104	Inverter Temp. High 1	The temperature of the inverter heat sink has exceeded the normal temperature level. Check cooling and heat sink conditions. Reduce the output current or ambient temperature.		X	X		C	C
0x4310	4105	Inverter Temp. High 2	The temperature of the inverter heat sink has reached a critical level. Check cooling and heat sink conditions. Reduce the output current to avoid a protected fault.		X	X		C	C
0x4310	4110	IGBT Temp. High	An inverter IGBT overtemperature has been detected. Reduce the ambient temperature, the output current and/or the switching frequency. Check the cooling and the condition of the heat sink.			X		C	C
0x4310	4113	Rectifier Temp. Limit	The temperature of the rectifier heat sink is at the upper limit of the normal temperature range. Check cooling and heat sink conditions. Reduce the output power (torque, speed) or the ambient temperature.		X				
0x4310	4114	Rectifier Temp. High 1	The temperature of the rectifier heat sink has exceeded the normal temperature range. Check cooling and heat sink conditions. Reduce the output power (torque, speed) or the ambient temperature.		X	X		C	C
0x4310	4115	Rectifier Temp. High 2	The temperature of the rectifier heat sink has reached a critical level. Check cooling and heat sink conditions. Reduce the output power (torque, speed) or the ambient temperature.		X	X		C	C

Table 40: Summary Table (continued)

Group Number (Hex)	Number (Decimal)	Display Name	Description	Type of Event				Inverter and Brake Chopper Action	
				I	W	F	P	Inverter	Brake
0x4310	4117	Power Unit Temp. Limit	The internal air temperature of the drive is at the upper limit of the normal temperature range. Check cooling and heat sink conditions. Reduce the output power (torque, speed) or the ambient temperature.		X				
0x4310	4118	Power Unit Temp. High 1	The internal air temperature of the drive has exceeded its normal temperature range. Check cooling and heat sink conditions. Reduce the output power (torque, speed) or the ambient temperature.		X	X		C	C
0x4310	4119	Power Unit Temp. High 2	The internal air temperature of the drive has reached a critical value. Check cooling and heat sink conditions. Reduce the output power (torque, speed) or the ambient temperature.		X	X		C	C
0x4310	4125	IGBT Temp. High	An inverter IGBT temperature has reached a critical value. Reduce the drive's output current if possible to avoid a protected fault.			X		C	C
0x4320	4102	Ambient Temp. Low	The drive is operated at a too low ambient temperature. Check the ambient temperature. Increase the ambient temperature or consider an external heater to increase the temperature around the drive.		X	X		C	C
0x4320	4112	Rectifier Temp. Low	The temperature of the rectifier heat sink is too low. Check the ambient temperature. Increase the ambient temperature or consider an external heater to increase the temperature around the drive.		X	X		C	C
0x4320	4116	Power Unit Temp. Low	The internal air temperature of the drive is below the normal operating range. The drive is operated at a too low ambient temperature. Consider an external heater to avoid this warning or fault.		X	X		C	C
0x4380	5240	Cooling Monitor	The cooling signal is missing.		X	X		C	C

Table 40: Summary Table (continued)

Group Number (Hex)	Number (Decimal)	Display Name	Description	Type of Event			Inverter and Brake Chopper Action		
				I	W	F	P	F	Inverter
0x43FE	4120	Control Board Temp. Low	The temperature of the control board is below the normal temperature range. The drive is operated at a too low ambient temperature. Check the ambient temperature. Increase the ambient temperature or consider an external heater to increase the temperature at the drive.		X	X		C	C
0x43FE	4121	Control Board Temp. Limit	The temperature of the control board is at the upper limit of the normal temperature range. Check cooling conditions and load of the control board. Reduce the load on the control board or the ambient temperature.		X				
0x43FE	4122	Control Board Temp. High 1	The temperature of the control board has exceeded its normal temperature range. Check cooling conditions and load of the control board. Reduce the load on the control board or the ambient temperature.		X	X		C	C
0x43FE	4123	Control Board Temp. High 2	The temperature of the control board has reached a critical level. Check cooling conditions and load of the control board. Reduce the load on the control board or the ambient temperature.		X	X		C	C
0x43FF	4124	Break Chopper Temperature Imbalance	There is a temperature imbalance between 1 or more brake chopper IGBT's.		X				
0x43FF	4126	IGBT Temperature Imbalance	There is a temperature imbalance between 1 or more IGBT's.		X				
0x43FF	4127	IGBT Temperature Imbalance	An excessive thermal imbalance between the IGBT modules has been detected. Check the condition of IGBT modules their connections the cooling and the driver boards.		X				
0x43FF	4131	Temperature Imbalance Brake IGBT	There is a temperature imbalance between 1 or more brake chopper IGBT's.		X	X		C	C
0x43FF	4132	IGBT temperature delta	There is a temperature imbalance between 1 or more IGBT's.		X	X		C	C
0x4480	5400	AHF High Temp. Derate	A too high temperature is detected in the connected AHF (Advanced Harmonic Filter). Output has been derated to 50%.			X			

Table 40: Summary Table (continued)

Group Number (Hex)	Number (Decimal)	Display Name	Description	Type of Event				Inverter and Brake Chopper Action	
				I	W	F	P	Inverter	Brake
0x4480	5401	AHF High Temp. Stop	A too high temperature has been detected in the connected AHF (Advanced Harmonic Filter). Operation of the drive has been stopped.			X		RC	
0x5100	4641	24V Backup Mode	The drive is in 24V backup mode. The control section (including parameter configurations) and installed options are kept operational.	X					
0x5112	4640	24V Supply Fault	The 24V supply is outside its normal operating range.				X	C	C
0x5114	4642	3.3V Supply Low	The voltage of the internal 3.3V supply is below its normal operating range.			X		C	C
0x5118	4643	28V Supply Low	The voltage of the internal 28V supply is below its normal operating range.			X		C	C
0x51FE	4644	Gate Driver Voltage Fault	The gate driver supply voltage is outside its normal operating range.				X	C	C
0x51FE	4653	Gate Driver Fault	A gate driver fault is detected or a link to the gate driver is broken.			X		C	C
0x51FF	4645	Power Board Supply Fault	A power supply fault on the power board has been detected.				X	C	C
0x51FF	4646	Power Supply Voltage	A power supply voltage is outside its normal operating range.				X	C	C
0x5210	4378	Current Sensor Fault	A defective current sensor or an error in the calibration of the current sensors has been detected.			X		C	C
0x5400	5173	Power Limit Timeout Regenerative	The drive has exceeded the allowed time in power limit.			X		C	
0x5400	5174	Power Limit Timeout Motoring	The drive has exceeded the allowed time in power limit.			X		C	
0x5480	4152	ShootThroughFaultIntAfe	Converter shoot-through detected			X		C	
0x54FD	4647	Function Disabled	The protection logic keeps the trip active until the configuration of the power unit protection levels is ready.			X		C	C
0x54FE	4628	STO Activated	The Safe Torque-Off (STO) is activated and an unintended restart is prevented until the STO-request has been reset.		X			C	

Table 40: Summary Table (continued)

Group Number (Hex)	Number (Decimal)	Display Name	Description	Type of Event				Inverter and Brake Chopper Action	
				I	W	F	P	Inverter	Brake
0x54FE	4629	STO Fault Ch. A	The Safe Torque-Off (STO) is activated due to a discrepancy fault: Channel A is not activated, while channel B is activated.			X		C	C
0x54FE	4630	STO Fault Ch. B	The Safe Torque-Off (STO) is activated due to a discrepancy fault: Channel B is not activated, while channel A is activated.			X		C	C
0x54FF	4149	DC-link Short Circuit	An internal short circuit is detected in the DC link. Service is required.				X	C	C
0x54FF	4150	DC Capacitor Short Circuit	A short circuit in a DC-link capacitor is detected. Service is required.			X		C	C
0x54FF	4151	DC-link Short Circuit 2	A short circuit in the DC-link capacitor is detected. Service is required.	X			X	C	
0x5530	4790	Control Data Error	A data error is detected in the control data database EEPROM.	X					
0x5530	4791	Invalid PUD	A data error has been detected in the power unit database EEPROM.			X		C	
0x6100	4134	SystemTimeAdjust	SystemTime has been adjusted	X					
0x6100	4135	RtcHwError	RTC HW error detected		X				
0x6100	4304	License Missing	A required license is missing.		X				
0x6100	4349	Authenticity Error	Files authenticity verification error occurred.			X		RC	C
0x6100	4351	System Fault	A system fault has been detected. See additional information for details.			X		C	C
0x6100	4357	Firmware Crash	A firmware crash occurred and detailed information is provided.			X		C	C
0x6100	4567	Restore Status	Provides information about the restore operation of a setting.	X					
0x6100	4568	AutomaticReset	All event conditions have cleared and triggered events have been automatically reset.	X					
0x6100	4816	PLC Task Overrun	The high CPU load is inhibiting normal operation of the application (PLC task overrun).		X				

Table 40: Summary Table (continued)

Group Number (Hex)	Number (Decimal)	Display Name	Description	Type of Event				Inverter and Brake Chopper Action	
				I	W	F	P	Inverter	Brake
0x6100	4817	PLC Runtime Error	The PLC runtime has stopped responding. The application has been halted.			X		C	C
0x6100	4832	Node Discovery	Node discovery and configuration are in progress. The modulation is inhibited.	X				RC	C
0x6100	4833	Node Commissioning	Nodes are being commissioned.		X			C	C
0x6100	4834	Node Missing	A previously commissioned node is no longer available. The drive is waiting for the node to be available. If the node has been removed, recommission the drive.	X					
0x6100	4853	StartupOccurrence	This occurrence masks over various occurrences that might be active during startup, that we dont want to show the end user	X					
0x6100	4854	ResetByDemand	Drive reset is requested by user, and will be performed shortly	X				C	
0x6100	4855	Internal Fault	An internal fault has been detected. Cycle power, check the wiring if applicable, contact the service provider if the fault persists. Note the occurrence number for further troubleshooting directions.			X		RC	C
0x6100	4856	Internal Fault	An internal fault has been detected (connection from controller). Cycle power, check the internal wiring, contact the service provider if the fault persists. Note the occurrence number for further troubleshooting directions.			X		C	C
0x6100	4857	Software Update	The drive is currently performing an update of the software.	X					
0x6100	5100	Start Disabled in Reference Direction	Start is disabled because 'Enable Start Forward' or 'Enable Start Backward' is not active via input.		X				
0x6180	5260	Event Simulation	The event with the number 5260 is simulated.		X	X		C	C
0x6180	5264	Event Simulation SS2 Inst 1	Event simulation SS2 Instance 1.		X			C	C

Table 40: Summary Table (continued)

Group Number (Hex)	Number (Decimal)	Display Name	Description	Type of Event			Inverter and Brake Chopper Action	
				I	F	P	Inverter	Brake
0x6180	5265	Event Simulation SS2 Inst 2	Event simulation SS2 Instance 2.	X			C	C
0x6181	4980	A Digital Input terminal is unknown by system	A digital input terminal has been selected that is unknown by system. Maybe an option has been moved or removed.	X				
0x6181	4981	A Digital Output terminal is unknown by system	A digital output terminal has been selected that is unknown by system. Maybe an option has been moved or removed.	X				
0x6181	4982	An Analog Input terminal is unknown by system	An analog input terminal has been selected that is unknown by system. Maybe an option has been moved or removed.	X				
0x6181	4983	An Analog Output terminal is unknown by system	An analog output terminal has been selected that is unknown by system. Maybe an option has been moved or removed.	X				
0x6181	4984	A Digital Output occupied	A digital output is in use by an other function or fieldbus. If a Fieldbus has taken control over a terminal, it has priority over parameter selection.	X				
0x6181	4985	An Analog Output occupied	An analog output is in use by an other function or fieldbus. If a Fieldbus has taken control over a terminal, it has priority over parameter selection.	X				
0x61F7	4800	Low Storage Space	The available storage space for the file system is low.	X				
0x61F7	4801	Data Logger Storage	Volume restriction limits are preventing additional data logger capture files from being stored.	X				
0x61F7	4802	Event Logger Storage	Volume restriction limits are preventing additional event log capture files from being stored.	X				
0x61FB	4600	Option Communication Fault	A fault of the communication with an option has been detected. Cycle power, check that the option is properly installed, contact the Danfoss supplier or the service department if the fault persists. Note the occurrence number for further troubleshooting directions.		X		RC	C

Table 40: Summary Table (continued)

Group Number (Hex)	Number (Decimal)	Display Name	Description	Type of Event				Inverter and Brake Chopper Action	
				I	W	F	P	Inverter	Brake
0x61FB	4601	Internal Communication Fault	An internal communication fault has been detected. Cycle power, check the wiring if applicable, contact the service provider if the fault persists. Note the occurrence number for further troubleshooting directions.		X				
0x61FB	4602	Option Communication Fault	A fault of the communication with an option has been detected. Cycle power, check that the option is properly installed, contact the Danfoss supplier or the service department if the fault persists. Note the occurrence number for further troubleshooting directions.			X		C	C
0x61FB	4607	Internal Communication Fault	An internal communication fault has been detected. Cycle power, check the wiring if applicable, contact the Danfoss supplier or the service department if the fault persists. Note the occurrence number for further troubleshooting directions.			X		C	C
0x61FB	4631	Internal Communication Fault	An internal communication fault has been detected. Cycle power, check the wiring if applicable, contact the Danfoss supplier or the service department if the fault persists. Note the occurrence number for further troubleshooting directions.			X		RC	C
0x61FB	4632	Internal Communication Fault	An internal communication fault has been detected. Cycle power, check the wiring if applicable, contact the service provider if the fault persists. Note the occurrence number for further troubleshooting directions.		X				
0x61FC	4605	Internal Communication Fault	An internal communication fault has been detected. Cycle power, check the wiring if applicable, contact the service provider if the fault persists. Note the occurrence number for further troubleshooting directions.			X		C	C

Table 40: Summary Table (continued)

Group Number (Hex)	Number (Decimal)	Display Name	Description	Type of Event			Inverter and Brake Chopper Action		
				I	W	F	P	Inverter	Brake
0x61FC	4606	Internal Communication Fault	An internal communication fault has been detected. Cycle power, check the wiring if applicable, contact the Danfoss supplier or the service department if the fault persists. Note the occurrence number for further troubleshooting directions.			X		C	C
0x61FC	4639	High Speed Bus Sync Error	Internal error detected with high-speed bus connection to parallel control unit.			X		C	C
0x61FC	4648	High Speed Bus Error	Internal error detected with high-speed bus connection to parallel control unit.			X		C	C
0x61FC	4858	Internal Fault	An internal fault has been detected. The power system has not received the required reference for modulation. Cycle power, check the wiring if applicable, contact the Danfoss supplier or the service department if the fault persists. Note the occurrence number for further troubleshooting directions.		X	X		C	
0x61FC	4859	Internal Fault	An internal fault (connection from power system) has been detected. Cycle power, check the internal wiring, contact the service provider if the fault persists. Note the occurrence number for further troubleshooting directions.		X	X		C	
0x61FC	4860	Unexpected Time Adjust	An internal fault (unexpected time adjustment) has been detected. Cycle power, check the internal wiring, contact the service provider if the fault persists. Note the occurrence number for further troubleshooting directions.			X		C	C
0x61FC	4861	Synchronization Fault	An internal fault (time synchronization error between controller and power system) has been detected. Cycle power, check the internal wiring, contact the service provider if the fault persists. Note the occurrence number for further troubleshooting directions.			X		C	C
0x61FC	4862	PDS	Internal error detected with high-speed bus connection from controller.			X		C	C

Table 40: Summary Table (continued)

Group Number (Hex)	Number (Decimal)	Display Name	Description	Type of Event				Inverter and Brake Chopper Action	
				I	W	F	P	Inverter	Brake
0x61FC	4863	Internal Fault	An internal fault (connection with power system) has been detected. Cycle power, check the internal wiring, contact the service provider if the fault persists. Note the occurrence number for further troubleshooting directions.			X		C	C
0x6320	4350	Configuration Error	An invalid system configuration has been detected.		X	X		C	C
0x6320	5301	Invalid Control Config.	An invalid control configuration is preventing operation.		X	X		C	
0x6320	5302	Start Blocked	Start of the motor is blocked. Check the Motor Ctrl. Ready Status Word for the cause.		X	X		C	
0x7012	5604	Motor Feedback Inversed	Feedback signal was negative running whereas motor was positive.			X		C	C
0x7012	5605	No Motor Feedback	Feedback signal 0 or very low.			X		C	C
0x7080	5220	Brake Feedback Wrong State	Mechanical brake feedback is in a wrong state. Feedback state should reflect state of brake, except during opening or closing phases.		X				
0x7080	5221	Brake Priming Timeout	Brake priming has timed out. The drive could not produce the configured priming torque to open the brake safely.		X				
0x7080	5222	Brake Feedback Timeout	Brake feedback has timed out. The feedback signal is indicating that the mechanical brake has not opened or closed within the configured time.		X				
0x70FF	4128	Control Fan Failure	The control board cooling fan is not running at the commanded speed.		X				
0x70FF	4129	Main Fan Failure	The main cooling fan is not following its reference speed. Check the fan's wiring and whether its blocked or polluted. Replace the fan if necessary.		X				

Table 40: Summary Table (continued)

Group Number (Hex)	Number (Decimal)	Display Name	Description	Type of Event				Inverter and Brake Chopper Action	
				I	W	F	P	Inverter	Brake
0x70F	4130	Internal Fan Failure	The internal fan is running below its reference speed. Check the fan's wiring and whether it's blocked or polluted. Replace the fan if necessary.		X				
0x70F	4133	LCL Fan Speed Fault	LCL cooling fan not tracking commanded output.			X		C	C
0x711	5204	Brake Resistor Test Active	The Brake Resistor Test is active. Normal run of the drive is not possible.		X				
0x711	5205	Brake Resistor Test Failed	The Brake Resistor Test was unsuccessful. Check the brake resistor and its connections.			X		C	C
0x711	5206	Brake Resistor Test Successful	The test of the brake resistor is performed successfully.	X					
0x711	4403	Brake Ch. Switch Shorted	A short circuit of the brake chopper switch has been detected, which can be dangerous. Disconnect power. Service is required.		X	X		C	
0x711	4400	Brake Chopper Overload	A brake chopper overcurrent has been detected. Reduce the brake voltage level and check the rating of the brake resistor.		X		X	C	C
0x711	4401	Brake Resistor Temp. High	The brake resistor temperature is too high. Check the rating of the brake resistor and cooling conditions. Reduce the generated regenerative power.		X	X		C	C
0x711	4402	Brake Resistor Missing	The brake resistor or its connection is missing.		X	X		C	
0x711	4404	Brake Failure	A brake failure is detected, further testing will clarify the failure source. Coast first to run the test.		X			C	
0x712	4177	Motor Thermal Overload	A thermal overload of the motor has been detected. Check if the shaft torque is too high.		X	X		C	
0x712	4178	Motor Speed High	The motor speed is above the normal operating range.		X	X		C	
0x712	4179	AMA Current Low	The nominal current of the motor is too low for accurate results of automatic motor adaptation (AMA).		X				

Table 40: Summary Table (continued)

Group Number (Hex)	Number (Decimal)	Display Name	Description	Type of Event				Inverter and Brake Chopper Action	
				I	W	F	P	Inverter	Brake
0x7120	4180	Rotor Angle Detection Error	Rotor angle detection has failed. This might be as the motor is not suited to the drive or the motor is missing.		X	X		C	
0x7120	4181	Low Motor Saliency For High Frequency Injection Mode	Motor saliency is too low for HF injection mode.		X	X		C	
0x7120	4382	Blocked Rotor	The rotor is blocked.		X	X		C	
0x7120	5200	AMA Active	The AMA (Automatic Motor Adaptation) is active. Normal run of the motor is not possible. Apply a start signal to run the AMA.		X				
0x7120	5201	AMA Motor Data	The motor data measurement of the AMA (Automatic Motor Adaptation) was unsuccessful.			X		C	C
0x7120	5202	AMA Motor Type	The motor type detection of the AMA (Automatic Motor Adaptation) was unsuccessful.			X		C	C
0x7120	5203	AMA Successful	The AMA (Automatic Motor Adaptation) has been performed successfully.	X					
0x7120	5300	Invalid Motor Data	Invalid motor data is preventing operation. Check the motor data settings.		X	X		C	
0x7120	5600	Feedback Test Active	Normal run suppressed for motor feedback test run.		X				
0x7120	5601	Feedback Test Successful	Motor feedback test was able to verify motor feedback signal.	X					
0x7120	5602	Feedback Resolution/ Poles High	Feedback signal was slower than expected.			X		C	C
0x7120	5603	Feedback Resolution/ Poles Low	Feedback signal was faster than expected.			X		C	C
0x7120	5606	Feedback Unstable	Feedback signal was inconsistent.			X		C	C
0x7122	4182	Motor Sync Loss	Select the drive response if the synchronization between motor and drive is lost. This is only relevant when using a permanent magnet or synchronous reluctance motor.		X	X		C	

Table 40: Summary Table (continued)

Group Number (Hex)	Number (Decimal)	Display Name	Description	Type of Event				Inverter and Brake Chopper Action	
				I	W	F	P	Inverter	Brake
0x72F	4417	Feedback Option Fault	The Feedback Option is indicating a fault condition.			X		C	C
0x7310	4418	Bad Speed Feedback	Speed Feedback value is not reliable.			X		C	
0x7500	4638	Drive to Drive Connection Lost	Drive to drive connection is lost.		X	X		C	C
0x7580	5141	Control Panel Connection Lost	The connection to the control panel is lost. Control via control panel is released.						
0x7580	5142	PC Connection Lost	The connection to the PC tool is lost. PC control is released.						
0x8100	4256	Address Conflict	The fieldbus has identified an Address Conflict on the network which made the device back off.		X				
0x8100	4257	Ethernet Cable Fault	At link down a measurement is done to measure the distance to the far end of the cable, indicating where the fault has occurred. This warning occurs at distances > 4 m and Link State Change Down. Actual distance shown in detailed info.		X				
0x8100	4258	Invalid Fieldbus Configuration	An issue due to an invalid configuration of the fieldbus connection has been detected. Features not supported by the device, mismatch between configured and actually available features or modules not available in the device. See additional detail info.	X	X				
0x8100	4260	Redundant Controller Missing	One or more of the expected fieldbus controllers are missing.		X				
0x8100	4261	Fieldbus Topology Mismatch	The current fieldbus topology does not match the topology provided at commissioning time.		X				
0x8100	4263	Ethernet Link Status Changed	There has been detected a change of the Ethernet link status. Additional info has details about which port and state.	X					
0x8100	4265	Ethernet Redundancy Error	Primary or backup physical paths has been detected missing.		X				

Table 40: Summary Table (continued)

Group Number (Hex)	Number (Decimal)	Display Name	Description	Type of Event				Inverter and Brake Chopper Action	
				I	W	F	P	Inverter	Brake
0x8100	4266	X1 Cable Redundancy	Indicates that physical path from X1 interface to the controller is missing or wrongly configured.		X				
0x8100	4267	X2 Cable Redundancy	Indicates that physical path from X2 interface to the controller is missing or wrongly configured.		X				
0x8100	4268	FieldbusStartUp	Internal occurrence to mask away TopologyMismatch occurrence during startup	X					
0x8100	4269	Network Time Protocol	Information of Network Time Protocol server. See detailed info.	X					
0x8100	4280	Controller Not in Run	Controller not in RUN state.		X				
0x8100	4281	Interface Configuration Change	Interface configuration changed. See detailed info.	X					
0x8100	5162	Alternative Control Place due to Fieldbus Timeout	Fieldbus process data timeout caused a change to the alternative control place.		X				
0x81FD	4270	No Modbus TCP Connection	No Modbus TCP communication is currently established. Can happen until first connection is established or if all connections have stopped (gracefully or disruptive).	X					
0x81FD	4271	No PROFINET Connection	No PROFINET I/O communication is currently established. Can happen until first connection is established or if all connections have stopped (gracefully or disruptive).	X					
0x81FD	4272	No EtherNet/IP Connection	No EtherNet/IP communication is currently established. Can happen until first connection is established or if all connections have stopped (gracefully or disruptive).	X					
0x81FD	4273	No EtherCAT Connection	No EtherCAT communication is currently established. Will happen during start-up until first connection is established. Or if all connections has stopped (gracefully or disruptive).	X					

Table 40: Summary Table (continued)

Group Number (Hex)	Number (Decimal)	Display Name	Description	Type of Event				Inverter and Brake Chopper Action	
				I	W	F	P	Inverter	Brake
0x81FD	4282	No Modbus TCP Connection	No Modbus RTU communication is currently established. Occurs during start-up until first connection is established, or if all connections has stopped (gracefully or disruptive).	X					
0x81FE	4274	Loss of Modbus TCP I/O	One or more of the Fieldbus I/O connections has failed. This can happen when an established Fieldbus I/O Connection has been disrupted by e.g cable break or powercut of PLC or other infrastructure components.		X				
0x81FE	4275	Loss of PROFINET I/O	One or more of the Fieldbus I/O connections has failed. This can happen when an established Fieldbus I/O Connection has been disrupted by e.g cable break or powercut of PLC or other infrastructure components.		X				
0x81FE	4276	Loss of EtherNet/IP I/O	One or more of the Fieldbus I/O connections has failed. This can happen when an established Fieldbus I/O Connection has been disrupted by e.g cable break or powercut of PLC or other infrastructure components.		X				
0x81FE	4277	Loss of EtherCAT Connection	One or more of the fieldbus I/O connections has failed. This can happen when an established fieldbus I/O Connection has been disrupted by e.g cable break or powercut of PLC or other infrastructure components.		X				
0x81FE	4283	Loss of Modbus RTU Connection	One or more of the fieldbus I/O connections has failed. This can happen when an established fieldbus I/O connection has been disrupted by for example cable break or powercut of PLC or other infrastructure components.		X				
0x81FF	4278	Primary Process Data Timeout	The fieldbus I/O data has not been updating any of the process data monitored by the primary process data monitor (Watchdog1). This can happen when the fieldbus has lost control or the current transferred I/O data is not valid.			X		C	C

Table 40: Summary Table (continued)

Group Number (Hex)	Number (Decimal)	Display Name	Description	Type of Event				Inverter and Brake Chopper Action	
				I	W	F	P	Inverter	Brake
0x81FF	4279	Secondary Process Data Timeout	The fieldbus I/O Data has not been updating any of the process data monitored by the secondary process data monitor (Watchdog2). This can happen when the fieldbus has lost control or the current transferred I/O data is not valid.			X		C	C
0x8331	5171	Torque Limit Timeout Motoring	The drive has exceeded the allowed time in torque limit.			X		C	
0x8331	5172	Torque Limit Timeout Regenerative	The drive has exceeded the allowed time in torque limit.			X		C	
0x8400	5210	Below Min. Speed	The Speed Monitor has detected that the speed is below the configured minimum speed.			X		C	C
0x8400	5211	Below Min. Speed	The Speed Monitor has detected that the speed is below the configured minimum speed.		X				
0x8400	5290	Speed Too High	The speed monitor has detected that the speed is above the configured maximum.			X		C	C
0x8400	5291	Speed Too High	The speed monitor has detected that the speed is above the configured maximum.		X				
0x8400	5292	Start Below Min. Speed	The start took too long. The speed has not reached the minimum speed within the time frame configured.			X		C	C
0x8611	4192	Position Following Error	The actual position is outside the allowed range of the position error window around a position demand value for longer than the position error delay.		X				
0x8612	4193	Position Limit	Motor position is outside the allowed range [PositionMin, PositionMax].		X	X		C	C
0x8612	4194	Position Command Rejected	Position command was rejected because of position software end limit.		X				
0x8612	4195	Hardware End Limit	The positioning controller detected that the drive is exceeding the hardware end Limits.		X	X		C	C
0x9080	5230	Lost Load Detected	Drive is not detecting any load on the motor shaft.						

Table 40: Summary Table (continued)

Group Number (Hex)	Number (Decimal)	Display Name	Description	Type of Event				Inverter and Brake Chopper Action	
				I	W	F	P	Inverter	Brake
0xF004	5270	Inertia Estimation Active	The drive is ready for performing the Inertia Estimation. A start command is required.		X				
0xF004	5271	Inertia Estimation Failed	The Inertia Estimation failed.			X		C	C
0xF004	5272	Inertia Estimation Successful	Inertia Estimation has been performed successfully.	X					
0xFF01	5123	External Exception 1	External Exception 1.			X		C	
0xFF01	5124	External Exception 2	External Exception 2.			X		C	

* indicates that the event's response can be configured using a parameter.

.....
Any information, including, but not limited to information on selection of product, its application or use, product design, weight, dimensions, capacity or any other technical data in product manuals, catalog descriptions, advertisements, etc. and whether made available in writing, orally, electronically, online or via download, shall be considered informative, and is only binding if and to the extent, explicit reference is made in a quotation or order confirmation. Danfoss cannot accept any responsibility for possible errors in catalogs, brochures, videos and other material. Danfoss reserves the right to alter its products without notice. This also applies to products ordered but not delivered provided that such alterations can be made without changes to form, fit or function of the product. All trademarks in this material are property of Danfoss A/S or Danfoss group companies. Danfoss and the Danfoss logo are trademarks of Danfoss A/S. All rights reserved.
.....

M0010401

