

Design Guide

DrivePro[®] Retrofit VLT[®] 2800 to VLT[®] Midi Drive FC 280



Easy retrofit
prepared for compatibility with the VLT[®] 2800 for a fast and streamlined retrofit

Contents

1	Introduction	5
1.1	Important User Information	5
1.2	Purpose of this Retrofit Design Guide	5
1.3	Additional Resources	5
1.4	Document and Software Version	5
1.5	Disposal	6
2	Safety	7
2.1	Safety Symbols	7
2.2	Qualified Personnel	7
2.3	Safety Precautions	7
3	Product Life Cycle Change Status	9
3.1	Important Customer Information	9
3.2	VLT® 2800 Successor Product VLT® Midi Drive FC 280	9
3.3	Advantages and Differences between VLT® 2800 and VLT® Midi Drive FC 280	10
4	Considerations for Converting VLT® 2800 to VLT® Midi Drive FC 280	12
4.1	Possible Configurations for VLT® Midi Drive FC 280	12
4.1.1	Manual Conversion Configuration VLT® Midi Drive FC 280	13
4.1.2	Conversion Configuration with MyDrive® Assistant	15
5	Comparing Mechanical Dimensions and Encumbrances	19
5.1	Enclosure Sizes, Power Ratings, and Dimensions	19
6	Selecting Accessories and Options for FC 280	23
6.1	Adapter Plate Accessories	23
6.2	VLT® Numeric Control Panel LCP 21	24
6.3	Graphic Display Option and LCP adapter for LCP 102	24
6.4	Memory Module and PROFIBUS Activation Emulator MCM 103	25
6.5	Convert IP20 to IP21/Type 1 Conversion Kit Option	26
6.6	Overview of Accessories	26
6.7	Recommended Spare Parts	27
7	Mechanical Installation, Wiring, and Cable Connections	29
7.1	Mechanical Installation	29
7.2	Electrical Installation	29
7.2.1	Grounding Principle for EMC-Compliant Installation	31
7.2.2	Cable Specifications	31

7.2.3	Connection Tightening Torques	32
7.3	Motor Connection	32
7.4	Terminal Comparison of I/O Control Wiring for VLT® Midi Drive FC 280	34
7.4.1	Terminal Descriptions for VLT® Midi Drive FC 280	36
7.4.2	Terminal Descriptions and Parameter Group	36
7.4.3	Terminal Function Comparison of Control Terminals for VLT® 2800 vs VLT® Midi Drive FC 280	38
7.5	Application Examples and Wiring for VLT® Midi Drive FC 280	39
7.5.1	Application Examples	40
7.5.1.1	AMA	40
7.5.1.2	Speed	40
7.5.1.3	Start/Stop	43
7.5.1.4	External Alarm Reset	43
7.5.1.5	Motor Thermistor	44
7.5.1.6	SLC	44
7.5.1.7	Safe Torque Off (STO)	45
7.6	Fuses and Circuit Breakers	45
7.6.1	Introduction	45
7.6.2	Recommendation of Fuses	45
8	Parameter Conversion Programming	48
8.1	Introduction	48
8.2	Parameters Conversion Process	48
8.3	Corresponding Parameter Groups	58
9	Integration with the Existing PROFIBUS Communication	60
9.1	PROFIBUS Fieldbus	60
9.2	Integration with Existing PROFIBUS Fieldbus	60
9.3	Software and Firmware to Support Existing Functionality	64
10	Relevant Technical Characteristics	66
10.1	Functions Comparison Between the 2 Drives	66
11	Commissioning Assistance and Installation Checklist	70
11.1	Commissioning Assistance	70
11.2	Installation Checklist	70
12	Retrofitting Non-Danfoss Drives	73
12.1	Configuration Assistance and Ordering	73

1 Introduction

1.1 Important User Information

There are many variables and requirements associated with any particular installation and application. The examples and diagrams in this manual are included solely for illustrative and guiding purposes. Danfoss Drives A/S and any other company in the Danfoss Group ("Danfoss") cannot assume responsibility or liability for the actual use based on the examples and diagrams in this guide. Because of the many variables and requirements associated with any particular installation and application, and also because of the wide variety of uses for solid-state equipment, all persons responsible for applying this equipment must satisfy themselves that each intended application of this equipment is acceptable. In no event will Danfoss be responsible or liable for any direct, indirect, or consequential damages resulting from the use or application of this equipment.

No patent liability is assumed by Danfoss, with respect to the use of information, circuits, equipment, or software described in this manual. Reproduction of the contents of this manual, in whole or in part, without written permission from Danfoss, is prohibited.

1.2 Purpose of this Retrofit Design Guide

This DrivePro® Retrofit Design Guide is to assist in selecting and basic setup of an FC 280 drive to replace a Danfoss VLT® 2800 drive.

- Technical data, features, and differences comparing the VLT® 2800 and FC 280 products.
- Configuration information on replacing the VLT® 2800 product to successor FC 280 drive.
- Options and accessories to complete conversion based on user installation requirements.
- Comparison of the relevant technical characteristics and basic setup of parameters and control wiring.

VLT® is a registered trademark for Danfoss A/S.

1.3 Additional Resources

Other resources are available to understand advanced drive functions, programming, and maintenance.

- VLT® Midi Drive FC 280 Operating Guide provides information about the installation, commissioning, application, and maintenance of the drive.
- VLT® Midi Drive FC 280 PROFIBUS DP Programming Guide is intended for use by qualified personal familiar with PROFIBUS technology and with the PC or PLC used as a master in the system. The guide provides information about configuring the system, controls, parameter access, programming, troubleshooting, and typical applications.
- VLT® Memory Module MCM 103 Installation Instructions provide information about installing the option VLT® Memory Module MCM 103 in the VLT® Midi Drive FC 280. The module acts as a combination of both memory module and activation module.
- Mounting Adapter to VLT® 2800 Installation Instructions provide information about installation of the mounting adapter for exchanging a VLT® 2800 with a VLT® Midi Drive FC 280.
- IP21/Type 1 Conversion Kit Installation Instructions provide information about installing the IP21/Type 1 conversion kit in VLT® Midi Drive FC 280.
- VLT® Motion Control Tool MCT 10 provides information on how to program the FC 280 drives.

All supplementary publications and manuals are available from following Danfoss website: www.danfoss.com/en/service-and-support/documentation/.

VLT® Motion Control Tool MCT 10 software download page: www.danfoss.com/en/service-and-support/downloads/dds/vlt-motion-control-tool-mct-10/#tab-overview.

1.4 Document and Software Version

This manual is regularly reviewed and updated. All suggestions for improvement are welcome.

The original language of this manual is English.

Table 1: Document and Software Version

Edition	Remarks	Software version
AJ440051329024, version 0101	First edition.	N/A

1.5 Disposal



Do not dispose of equipment containing electrical components together with domestic waste.
Collect it separately in accordance with local and currently valid legislation.

2 Safety

2.1 Safety Symbols

The following symbols are used in this guide:

⚠ D A N G E R ⚠

Indicates a hazardous situation which, if not avoided, will result in death or serious injury.

⚠ W A R N I N G ⚠

Indicates a hazardous situation which, if not avoided, could result in death or serious injury.

⚠ C A U T I O N ⚠

Indicates a hazardous situation which, if not avoided, could result in minor or moderate injury.

N O T I C E

Indicates information considered important, but not hazard-related (for example, messages relating to property damage).

2.2 Qualified Personnel

Correct and reliable transport, storage, installation, operation, and maintenance are required for the trouble-free and safe operation of the drive. Only qualified personnel are allowed to install and operate this equipment.

Qualified personnel are defined as trained staff, who are authorized to install, commission, and maintain equipment, systems, and circuits in accordance with pertinent laws and regulations. Also, the qualified personnel must be familiar with the instructions and safety measures described in this manual.

2.3 Safety Precautions

⚠ W A R N I N G ⚠

HAZARDOUS VOLTAGE

AC drives contain hazardous voltage when connected to the AC mains or connected on the DC terminals. Failure to perform installation, start-up, and maintenance by skilled personnel can result in death or serious injury.

- Only skilled personnel must perform installation, start-up, and maintenance.

⚠ W A R N I N G ⚠

UNINTENDED START

When the drive is connected to AC mains, DC supply, or load sharing, the motor may start at any time. Unintended start during programming, service, or repair work can result in death, serious injury, or property damage. Start the motor with an external switch, a fieldbus command, an input reference signal from the local control panel (LCP), via remote operation using MCT 10 software, or after a cleared fault condition.

- Disconnect the drive from the mains.
- Press [Off/Reset] on the LCP before programming parameters.
- Ensure that the drive is fully wired and assembled when it is connected to AC mains, DC supply, or load sharing.

⚠ W A R N I N G ⚠

DISCHARGE TIME

The drive contains DC-link capacitors, which can remain charged even when the drive is not powered. High voltage can be present even when the warning indicator lights are off.

Failure to wait the specified time after power has been removed before performing service or repair work could result in death or serious injury.

- Stop the motor.
- Disconnect AC mains, permanent magnet type motors, and remote DC-link supplies, including battery back-ups, UPS, and DC-link connections to other drives.
- Wait for the capacitors to discharge fully before performing any service or repair work. The discharge time is specified in the operating guide and on the drive nameplate.
- Use a measuring device to make sure that there is no voltage before opening the drive or performing any work on the cables.

⚠ W A R N I N G ⚠

ELECTRICAL SHOCK HAZARD - LEAKAGE CURRENT HAZARD >3.5 MA

Leakage currents exceed 3.5 mA. Failure to connect the drive properly to protective earth (PE) can result in death or serious injury.

- Ensure reinforced protective earthing conductor according to IEC 60364-5-54 cl. 543.7 or according to local safety regulations for high touch current equipment. The reinforced protective earthing of the drive can be done with:
 - a PE conductor with a cross-section of at least 10 mm² (8 AWG) Cu or 16 mm² (6 AWG) Al.
 - an extra PE conductor of the same cross-sectional area as the original PE conductor as specified by IEC 60364-5-54 with a minimum cross-sectional area of 2.5 mm² (14 AWG) (mechanical protected) or 4 mm² (12 AWG) (not mechanical protected).
 - a PE conductor completely enclosed with an enclosure or otherwise protected throughout its length against mechanical damage.
 - a PE conductor part of a multi-conductor power cable with a minimum PE conductor cross-section of 2.5 mm² (14 AWG) (permanently connected or pluggable by an industrial connector. The multi-conductor power cable shall be installed with an appropriate strain relief).
- NOTE: In IEC/EN 60364-5-54 cl. 543.7 and some application standards (for example IEC/EN 60204-1), the limit for requiring reinforced protective earthing conductor is 10 mA leakage current.

⚠ W A R N I N G ⚠

EQUIPMENT HAZARD

Contact with rotating shafts and electrical equipment can result in death or serious injury.

- Ensure that only trained and qualified personnel perform installation, start-up, and maintenance.
- Ensure that electrical work conforms to national and local electrical codes.
- Follow the procedures in this manual.

⚠ C A U T I O N ⚠

INTERNAL FAILURE HAZARD

An internal failure in the drive can result in serious injury when the drive is not properly closed.

- Ensure that all safety covers are in place and securely fastened before applying power.

3 Product Life Cycle Change Status

3.1 Important Customer Information

Danfoss Life Cycle Management Model has been created to provide comprehensive support for our valued customers and to ensure that they have continuous access to lifecycle services. When a product enters in the inactive phase of the lifecycle, the product is no longer in production, and spare parts and service options are no longer available. When a product in the inactive phase reaches the end of useful life, retrofitting to a new drive in the active production is the only option. Danfoss has standardized the life cycle concept for the drive products and service portfolio. The purpose of the life cycle concept is to ensure the best possible return on investment for the customer's installation.

3.2 VLT® 2800 Successor Product VLT® Midi Drive FC 280

After approximately 20 years of production, VLT® 2800 has been discontinued by Danfoss Power Electronics and Drives as it no longer meets the following standards:

EU RoHS 2.0- Restriction of the use of certain Hazardous Substances in electrical and electronic equipment.



Illustration 1: VLT® 2800

The VLT® 2800 has reached the inactive phase of its life cycle and is no longer in active production. The last time to buy date was 2017/4/21, and according to the ISO 9000 approved Danfoss standard No. 501G0366 the service support period ends 2022/4/21.



Illustration 2: VLT® 2800 Life Cycle Phase

Inactive phase: The VLT® 2800 has reached the inactive phase of its lifecycle, which means it is discontinued and no longer in production. Spare parts and service options are no longer available. Operating a drive in this phase may result in unpredictable process downtime due to wear or failure.



Illustration 3: VLT® Midi Drive FC 280

The VLT® Midi Drive FC 280 is more than just a successor. FC 280 is simply the best alternative and offers full backwards compatibility. FC 280 offers several additional functions which make this new drive flexible, communicative, easy to use, and best fit for the application. The drive saves space with its compact enclosure and design for side-by-side mounting and offers a wide range of powerful standard and optional features. For easy commission or service, it connects easily to a PC via USB port.

The VLT® Midi Drive FC 280 is an easy retrofit for the VLT® 2800 using an adapter plate.

Key features:

- Power range:
 - 3x380–480 V: 0.37–22 kW (0.5–30 hp).
 - 3x200–240 V: 0.37–3.7 kW (0.5–5.0 hp).
 - 1x200–240 V: 0.37–2.2 kW (0.5–3.0 hp).
- Current overload 160%/60 s, up to 180%/1 s.
- IP20, IP21/NEMA1 external option kit.
- Integrated EMC filter (VLT® 2800 compatible cable lengths).
- Pluggable control terminals.
- Pluggable power terminals up to 7.5 kW (10 hp).
- Functional safety: STO dual channel (SIL 2 IEC 61508 & IEC 62061/PLd ISO 13849-1).
- Memory module (firmware and parameter).
- Communication interface USB port and Modbus RTU (built in).
- Optional fieldbuses as control card variants: CANopen, PROFIBUS DP, PROFINET, EtherCAT, POWERLINK, and FC profile.
- CE/UL/EAC approval.

3.3 Advantages and Differences between VLT® 2800 and VLT® Midi Drive FC 280

e30bj193.10

Illustration 4: VLT® 2800 and VLT® Midi Drive FC 280

Not all VLT® 2800 can be converted (drives in unusual configurations). Using the *Drive Configurator* tools (in [4.1.2 Conversion Configuration with MyDrive® Assistant](#)) suggests the replacement product that is closest to the drive to be replaced, if not able to make an exact match. For this reason, all the code numbers obtained with the tools must therefore be verified to ensure adequate selection. Contact a Danfoss partner for assistance in this regard.

VLT® Midi Drive FC 280 advantages

Advanced features of VLT® Midi Drive FC 280 are as follows:

- Designed to replace the VLT® 2800, same width, or smaller.
- Adapter plate for mounting replacement drives that fits over existing holes.
- All FC 280 power range drives include built-in DC chokes to reduce THDi<48% according to EN 61000-3-2.
- All 3-phase VLT® Midi Drive FC 280 power range drives include integrated brake chopper.
- Optional to order control panel LCP 102 graphical display or LCP 21 numerical display.
- Integrated EMC filter, C1/C2 and C3 variants according to EN 61800-3.
- Built-in RFI disconnect for compatibility with IT mains.
- All control and power terminals are pluggable, avoid wiring errors.
- Cable lengths and setup software tools are backwards compatible.
- PROFIBUS converter via MCM 103 memory and backup module.
- Automatic parameter conversion tool with MCT 10 software.
- Wizard application setup.
- Integrated fieldbuses, Modbus RTU, and Danfoss FC profile.
- Communication interface RS485 and USB.

Optional fieldbus options

- Fieldbuses as control card variants: CANopen, PROFIBUS DP, PROFINET, EtherCAT, POWERLINK, and FC profile.

⚠ CAUTION ⚠

Differences to be aware when ordering VLT® Midi Drive FC 280:

- VLT® 2800 with DeviceNet communication option cannot be replaced with an FC 280, as this option is not available.
- The installation adapter plate is ordered as an external accessory to match the existing mounting holes of the VLT® 2800.
- The LCP display panels are ordered as an external accessory, it is not included as standard by default.
- The IP21/NEMA1 enclosure external accessory cannot be stacked side by side, whereas the IP20 can be stacked side by side.
- The VLT® 2800 accessories are not compatible with FC 280.
- The power options (external power accessories) for the VLT® 2800 are not always compatible and usable in combination with the new VLT® Midi Drive FC 280. Always check compatibility with the help of the VLT® Midi Drive FC 280 Design Guide.
- The single-phase VLT® 2800 with brake chopper cannot be replaced because there is no corresponding VLT® Midi Drive FC 280 with this option (the brake chopper is always present included by default on the 3-phase versions).

See chapter [6 Selecting Accessories and Options for FC 280](#) for the list of accessories and power options.

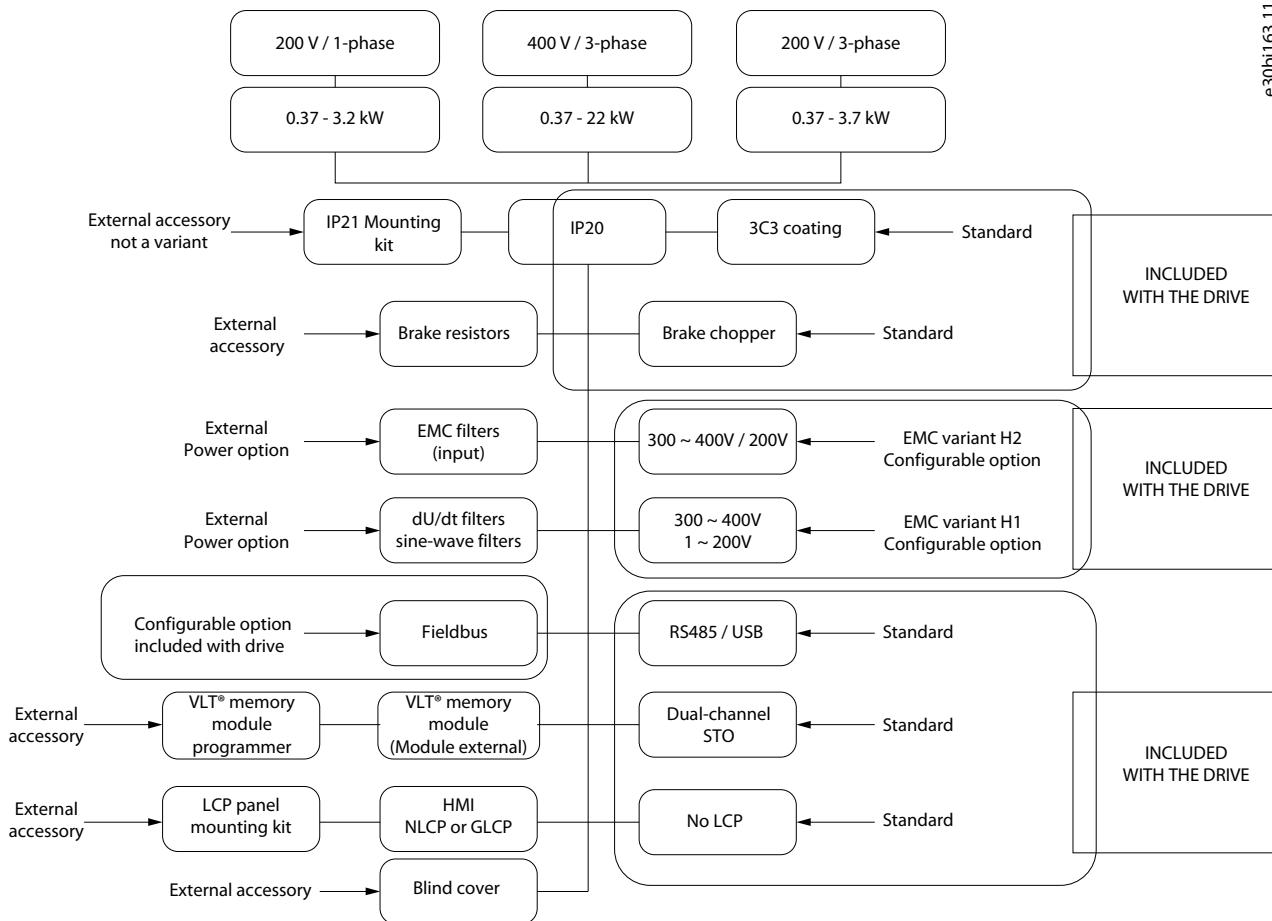

Illustration 5: Comparable Dimensions (VLT® Midi Drive FC 280 and VLT® 2800) and Easy Installation Using Adapter Plates

4 Considerations for Converting VLT® 2800 to VLT® Midi Drive FC 280

4.1 Possible Configurations for VLT® Midi Drive FC 280

The following illustration shows the configurable options included with the drive as standard features and the accessories required to be ordered separately when configuring the VLT® Midi FC 280 drive.



e30bj163.11

Illustration 6: Possible Configurable Selections for VLT® Midi Drive FC 280

Examples of accessories that are components ordered separately:

- Adapter plates can be ordered for easy, fast mounting of VLT® Midi Drive FC 280 without drilling new mounting holes.
- Ready-made kit to convert from IP20 to IP21 ingress protection class.
- Control and panels kits, LCP 102 graphical display or LCP 21 numerical display, or blind cover plate.

Examples of options that are configurable variants included with the drive and configurable characters in the product type code:

- EMC (H1 or H2) variant.
- Modbus RTU is included as standard.
- Fieldbus options as control card variants:
 - PROFINET with dual port.
 - EtherNet/IP with dual port.
 - PROFIBUS.
 - CANopen.
 - EtherCat.
 - POWERLINK.

See chapter 6 [Selecting Accessories and Options for FC 280](#) for the list of accessories to order in addition to the VLT® Midi Drive FC 280.

See [4.1.1 Manual Conversion Configuration VLT® Midi Drive FC 280](#) and [4.1.2 Conversion Configuration with MyDrive® Assistant](#) on how to order selectable option variants included with the drive.

4.1.1 Manual Conversion Configuration VLT® Midi Drive FC 280

NOTICE

The VLT® 2800 drive label description of the alpha numerical code information referring to the new VLT® Midi Drive FC 280 are different.

- VLT® 2800 terminology:
- VLT® 2800 Type code. Alpha numerical string representing the configuration for power rating, functions, and features of the hardware and software.
- VLT® 2800 Order code. Is the unique ordering sales code number for ordering drive with specific type code configuration.
- New VLT® Midi drive FC 280 terminology:
- VLT® Midi drive FC 280 Model code. Alpha numerical string representing the configuration for power rating, functions, and features of the hardware and software.
- VLT® Midi drive FC280 Code number. Is the unique ordering sales code number for ordering drive with specific type code configuration.

To obtain the new model code of the VLT® Midi Drive FC 280 drive autonomously without using the online tools, it is necessary to start from the interpretation of the configuration model code string to obtain the corresponding model code for the VLT® Midi Drive FC 280.

To get help for configuring the AC drive, contact a Danfoss representative. All combinations are not possible.

[1]	[2]	[3]	[4]	[5]	[6]	[7]	[8]	[9]	[10]	[11]	[12]	[13]	[14]					
FC-	280	-P2K2	-T4	-E20	-H2	-B	-X	-C	-X	-X	-X	-Sxxx	-X	-AL				
[1] Application (character 4-6)	280 VLT® Midi Drive FC 280	[2] Power size (character 7-10)	P2K2 2.2 kW/3.0 HP	[3] AC Line Voltage (character 11-12)	T4 3 x 380/480 V AC	[4] Enclosure (character 13-15)	E20 IP20/Chassis	[5] RFI filter, terminal and monitoring options - EN/IEC 61800-3 (character 16-17)	H2 RFI-Filter, Class A2 (C3)	[6] Braking (character 18)	X No brake IGBT (S2 only)	[7] LCP Display (character 19)	X No LCP installed	[8] PCB Coating - IEC 721-3-3 (character 20)	C Coated PCB Class 3C3			
[9] Mains input (character 21)	X No mains option	[10] Hardware option A (character 22)	X Standard cable entries	[11] Hardware option B (character 23)	X No adaptation	[12] Special version (character 24-27)	SXXX Latest released standard software	[13] LCP language (character 28)	X English, German, French, Spanish, Danish, Italian, Brazilian-Portuguese	Contact factory for other language options	[14] Integrated fieldbus (character 29-30)	AX Modbus RTU	A0 PROFIBUS DP	A6 CANopen	A8 EtherCAT	AL PROFINET	AN EtherNet/IP™	AY POWERLINK

e3obj195.11

Illustration 7: Example of Selections using the Manual Configuration Template to Create A New Model Code

The result of the example of the above image selections is a string of characters describing the configuration of the drive as follows:

- New model code: FC-280P2K2T4E20H2BXCXXXSXXXAL.
- P2K2: 2.2 kW/3.0 hp.
- T4: 3-phase 380–480 V AC.
- E20: IP20/chassis.
- H2: EMC Cat C3 (200/400V).
- B: Brake chopper.
- X: No display.

Design Guide

- C: Coated PCB.
- AL: Integrated PROFINET.
- Enclosure size is not shown in the new model code.

See chapter [6 Selecting Accessories and Options for FC 280](#) for the list of accessories to order, in addition to the VLT® Midi Drive FC 280.

Ordering example

Contact a Danfoss partner with the selected type code: FC-280P2K2T4E20H2BXCXXSXXXXAL.

-or-

Enter the type code in the search browser in the home page of the *Product Store* and follow the instructions to add any accessories required to complete conversion.



Illustration 8: Search Field in Danfoss Product Store

4.1.2 Conversion Configuration with MyDrive® Assistant

MyDrive® Assistant helps to find information, answer common questions, or troubleshoot VLT® and VACON® motor drives and power converters. The MyDrive® Assistant online conversion tool is available on the Danfoss webpage. Login without credentials on <https://mydrivechatbot.danfoss.com>.

NOTICE

- The MyDrive® Assistant conversion tool configures the new VLT® Midi Drive FC280 product based on the old VLT® 2800 by default. However, there are manual selections that are required for options, extras, and accessories to complete the conversion.
- Options, extras, and accessories are described in chapter [5 Comparing Mechanical Dimensions and Encumbrances](#) and [6 Selecting Accessories and Options for FC 280](#).

Procedure: Steps for replacing drives that are no longer in production with the most suitable successor drive.

1. Access <https://mydrivechatbot.danfoss.com> without credentials.

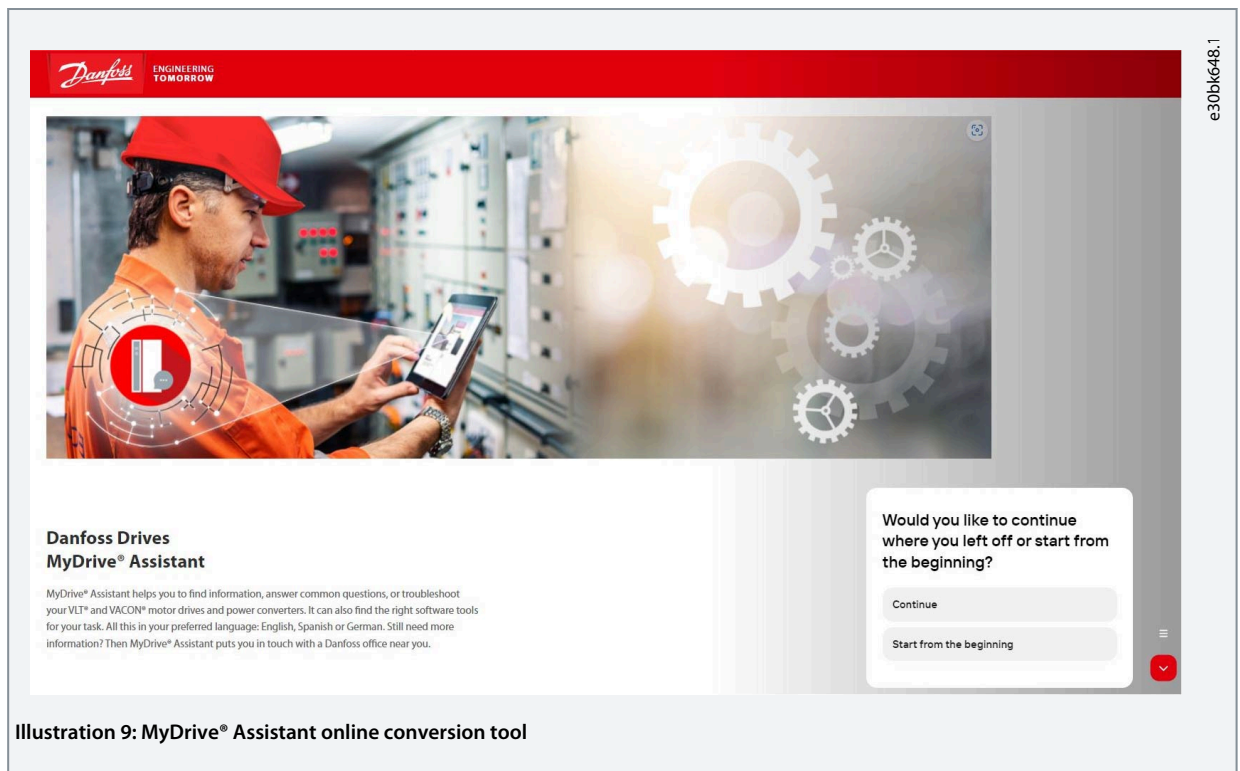

Illustration 9: MyDrive® Assistant online conversion tool

2. Select *Start from beginning* in the menu.

3. Select *DrivePro® Retrofit*.

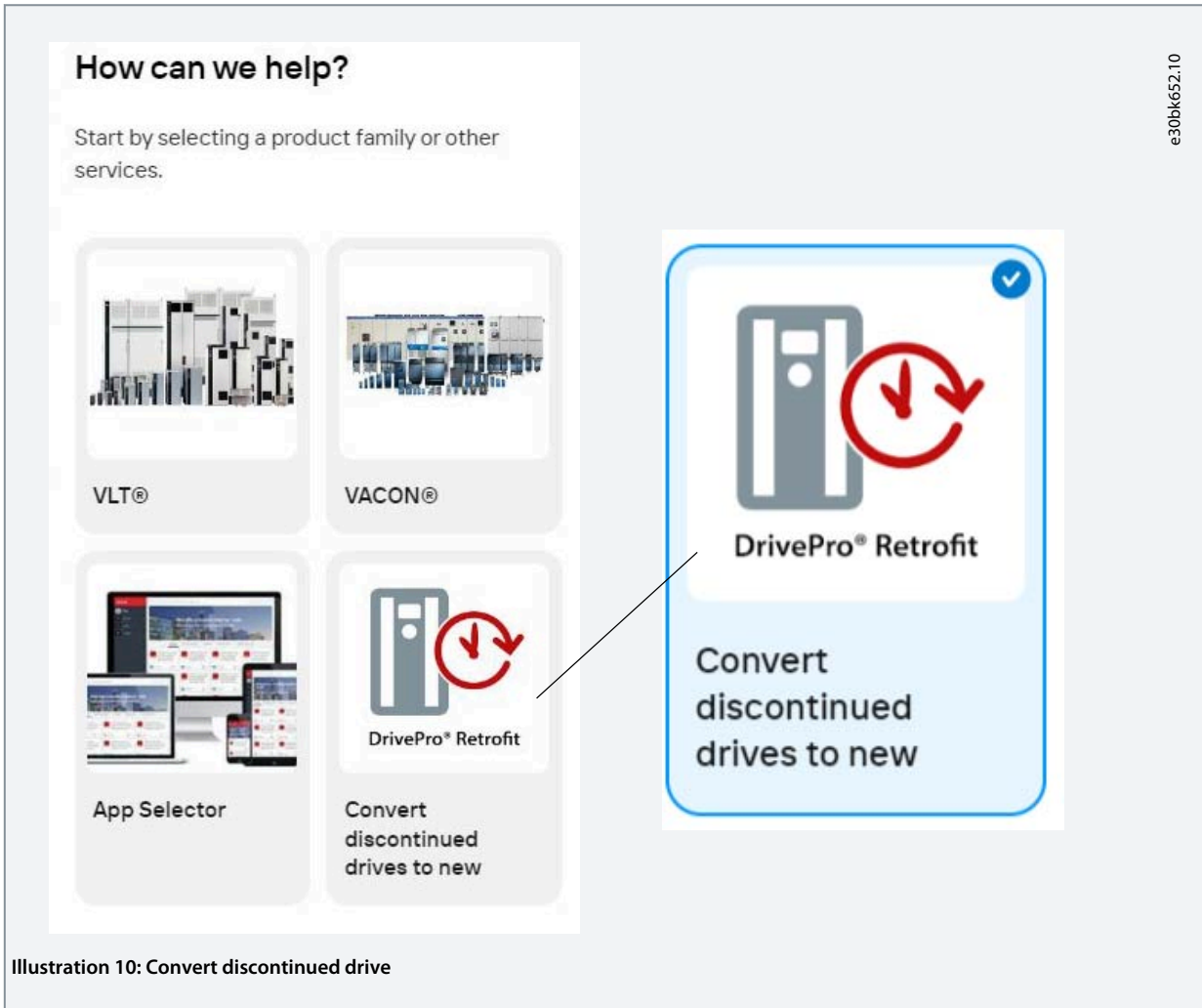

Illustration 10: Convert discontinued drive

4. Select *Find a replacement drive for VLT® 2800*.
5. Select *Search by type code* or *Search by sales code*. Use the search field to type in either the type code or sales code for the VLT® 2800.

To select options and accessories necessary to complete the conversion to new VLT®Midi Drive FC 280, follow the instructions.

Use the search field then select the type code of your VLT® 2800 drive

Search

VLT2803PS2B2OSBR1DBF00A00C1

VLT2803PD2B2OSBR0DBF12A00C1

VLT2803PS2B2OSBR1DBF12A00C1

VLT2803PS2B2OSBR4DBF00A00C1 ✓

Search by type code

Search by sales code

Illustration 11: MyDrive® Assistant Search Field

➔ MyDrive® Assistant conversion tool generates the numerical *Model code* string or the 8-digit *Code number* for ordering.

6. Review the configuration.

Corresponding Type Code Match

VLT® 2800 Type Code
VLT2803PS2B2OSBR1DBF12A00C1

VLT® 2800 Sales Code
134H2362

VLT 2800	W	H	D	Frame Size
Dimensions [cm]	200	75	168	A
Mounting holes [cm]	191	60		

Voltage Rating [Vac]	Power rating [kW]	EMC Class	Protocol Support
1x200	0.37	C2	PB 12Mbit

Corresponding New Model Code
FC-280PK37S2E20H1XXCXXXSXXXXA0

Corresponding New Code Number
134X3064

FC280	W	H	D	Frame Size
Dimensions [cm]	200	75	168	K1
Mounting holes [cm]	198.2	60		

Voltage Rating [Vac]	Power rating [kW]	EMC Class	Protocol Support
1x200	0.37	C2 / C1	Profibus

Illustration 12: Corresponding Code Match (Example)

7. Check the *New model code* for the new VLT®Midi Drive FC 280.
8. Check the *New code number* for the new VLT®Midi Drive FC 280.
9. MyDrive® Assistant conversion tool directly links to the Danfoss Product Store for ordering.

Login credentials are needed for ordering products in <https://store.danfoss.com>. It is also possible to establish a project list with several products and send the order to the local Danfoss sales office. Not registered in the Danfoss store? Contact the Danfoss Customer Service Center.

5 Comparing Mechanical Dimensions and Encumbrances

5.1 Enclosure Sizes, Power Ratings, and Dimensions

The VLT® Midi Drive FC 280 has same width as VLT® 2800 or smaller.

VLT® 2800 has 4 enclosure sizes and mechanical dimensions. The VLT® Midi Drive FC 280 has 5 enclosure sizes and mechanical dimensions as shown in the following illustration.

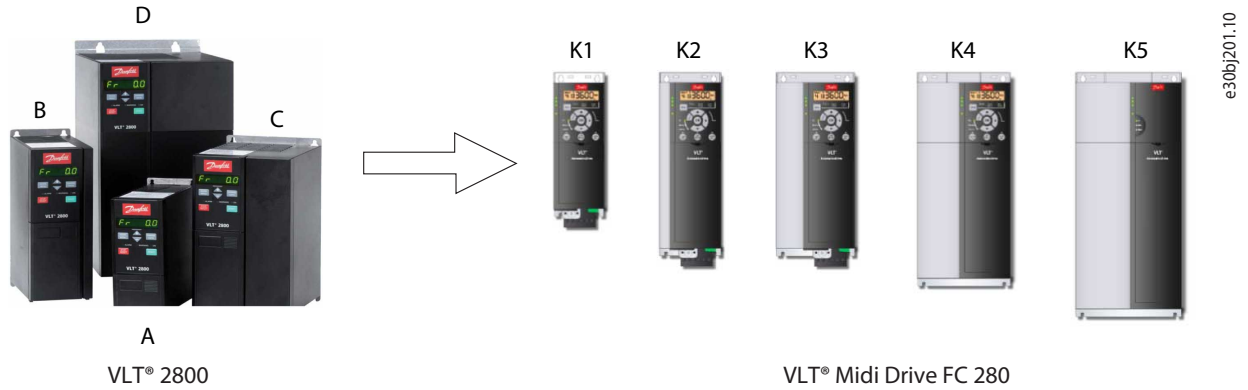

Illustration 13: Enclosure Sizes Comparison

Table 2: VLT® 2800 Enclosure Sizes and Dimensions

Enclosure Size		A	B	C	D
Type code character		VLT 2803-2815	VLT 2822-2840	VLT 2855-2875	VLT 2880-2882
Power size [kW (hp)]		0.37–1.5 (0.5–2.0)	2.2–4 (3.0–5.5)	5.5–7.5 (7.5–10)	11–18.5 (15–25)
Dimensions [mm (in)]	Height	200 (7.9)	268 (10.6)	268 (10.6)	505 (19.9)
	Width	75 (3.0)	90 (3.5)	140 (5.5)	200 (7.9)
	Depth	168 (6.6)	168 (6.6)	168 (6.6)	244 (9.6)

Enclosure size VLT® 2800		A (200 V)		A				B			C		D						
Enclosure size FC 280		K1										K2		K3		K4		K5	
Power size [kW (hp)]	3x400 V	0.37 (0.5)	0.55 (0.75)	0.75 (1.0)	1.1 (1.5)	1.5 (2.0)	2.2 (3.0)	3.0 (4.0)	4.0 (5.5)	5.5 (7.5)	7.5 (10)	11 (15)	15 (20)	18.5 (25)	22 (30)				
	3x200 V	0.37 (0.5)	0.55 (0.75)	0.75 (1.0)	1.1 (1.5)	1.5 (2.0)	2.2 (3.0)		3.7 (5.0)										
	1x200 V	0.37 (0.5)	0.55 (0.75)	0.75 (1.0)	1.1 (1.5)	1.5 (2.0)	2.2 (3.0)												

Illustration 14: Enclosure Sizes and Power Ratings Comparison

Enclosure size VLT® 2800		A		B			C			D		
Enclosure size FC 280		K1		K2			K3		K4		K5	
Dimensions [mm (in)]		200x75x168 (7.9x3.0x6.6)		268x90x168 (10.6x3.5x6.6)			268x140x168 (10.6x5.5x6.6)			505x200x244 (19.9x7.9x9.6)		
Dimensions [mm (in)]		210.5x75x168 (8.3x3.0x6.6)		272.5x90x168 (10.7x3.5x6.6)			317.5x133x245 (12.5x5.2x9.6)		317.5x133x245 (12.5x5.2x9.6)		410x150x245 (16.1x5.9x9.6)	

Illustration 15: Enclosure Sizes and Mechanical Dimensions Comparison (Height/Width/Depth)

NOTICE

Adapter plates facilitate the installation of VLT® Midi Drive FC 280 without drilling any new mounting holes, see [6.1 Adapter Plate Accessories](#).

Table 3: VLT® Midi Drive FC 280 Enclosure Sizes, Dimensions, and Mounting

Enclosure Size		K1	K2	K3	K4	K5
	VLT® Midi Drive FC 280 IP20					
Dimensions [mm (in)]	Height A1	210 (8.3)	272.5 (10.7)	272.5 (10.7)	317.5 (12.5)	410 (16.1)
	Height A2	278 (10.9)	340 (13.4)	341.5 (13.4)	379.5 (14.9)	474 (18.7)
	Width B	75 (3.0)	90 (3.5)	115 (4.5)	133 (5.2)	150 (5.9)
	Depth C	168 (6.6)	168 (6.6)	168 (6.6)	245 (9.6)	245 (9.6)
	VLT® Midi Drive FC 280 with IP21/UL/Type 1 kit					
	Height A	338.5 (13.3)	395 (15.6)	395 (15.6)	425 (16.7)	520 (20.5)
	Width B	100 (3.9)	115 (4.5)	130 (5.1)	153 (6.0)	170 (6.7)
	Depth C	183 (7.2)	183 (7.2)	183 (7.2)	260 (10.2)	260 (10.2)
	VLT® Midi Drive FC 280 with bottom cable entry cover (w/o top cover)					
	Height A	294 (11.6)	356 (14)	357 (14.1)	391 (15.4)	486 (19.1)
	Width B	75 (3.0)	90 (3.5)	115 (4.5)	133 (5.2)	150 (5.9)
	Depth C	168 (6.6)	168 (6.6)	168 (6.6)	245 (9.6)	245 (9.6)
Weight [kg (lb)]	IP20	2.5 (5.5)	3.6 (7.9)	4.6 (10.1)	8.2 (18.1)	11.5 (25.4)
	IP21	4.0 (8.8)	5.5 (12.1)	6.5 (14.3)	10.5 (23.1)	14.0 (30.9)
Mounting holes [mm (in)]	a	198 (7.8)	260 (10.2)	260 (10.2)	297.5 (11.7)	390 (15.4)
	b	60 (2.4)	70 (2.8)	90 (3.5)	105 (4.1)	120 (4.7)
	c	5 (0.2)	6.4 (0.25)	6.5 (0.26)	8 (0.32)	7.8 (0.31)
	d	9 (0.35)	11 (0.43)	11 (0.43)	12.4 (0.49)	12.6 (0.5)
	e	4.5 (0.18)	5.5 (0.22)	5.5 (0.22)	6.8 (0.27)	7 (0.28)
	f	7.3 (0.29)	8.1 (0.32)	9.2 (0.36)	11 (0.43)	11.2 (0.44)

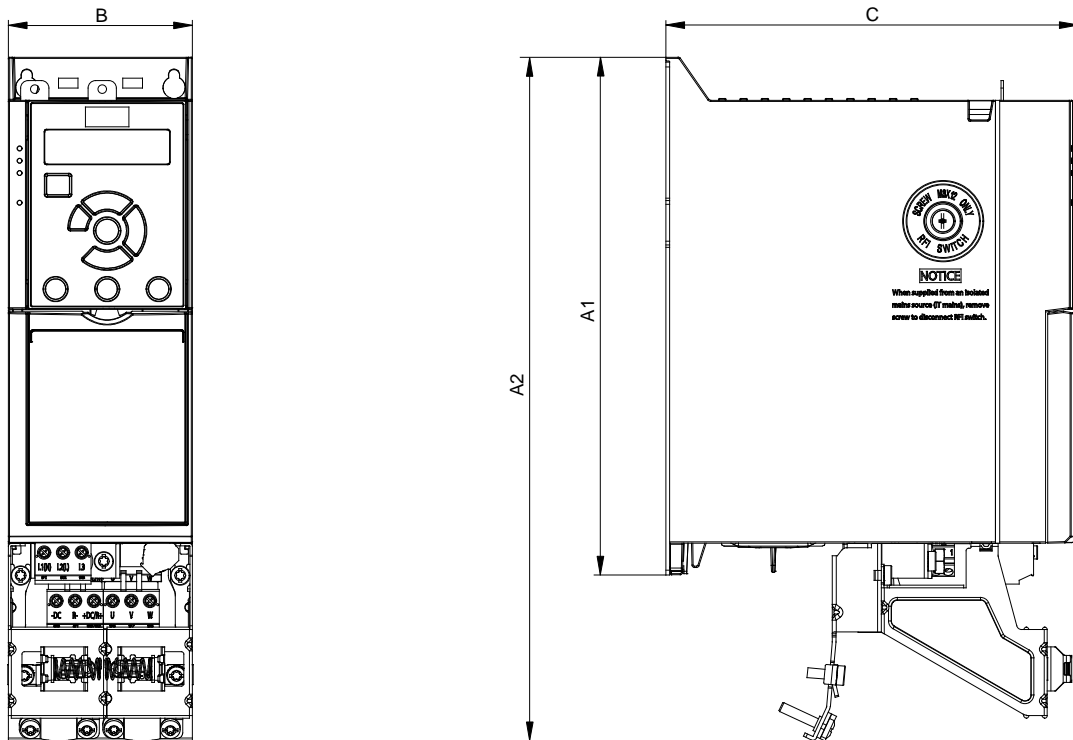

e30be844.11

Illustration 16: Standard with Decoupling Plate

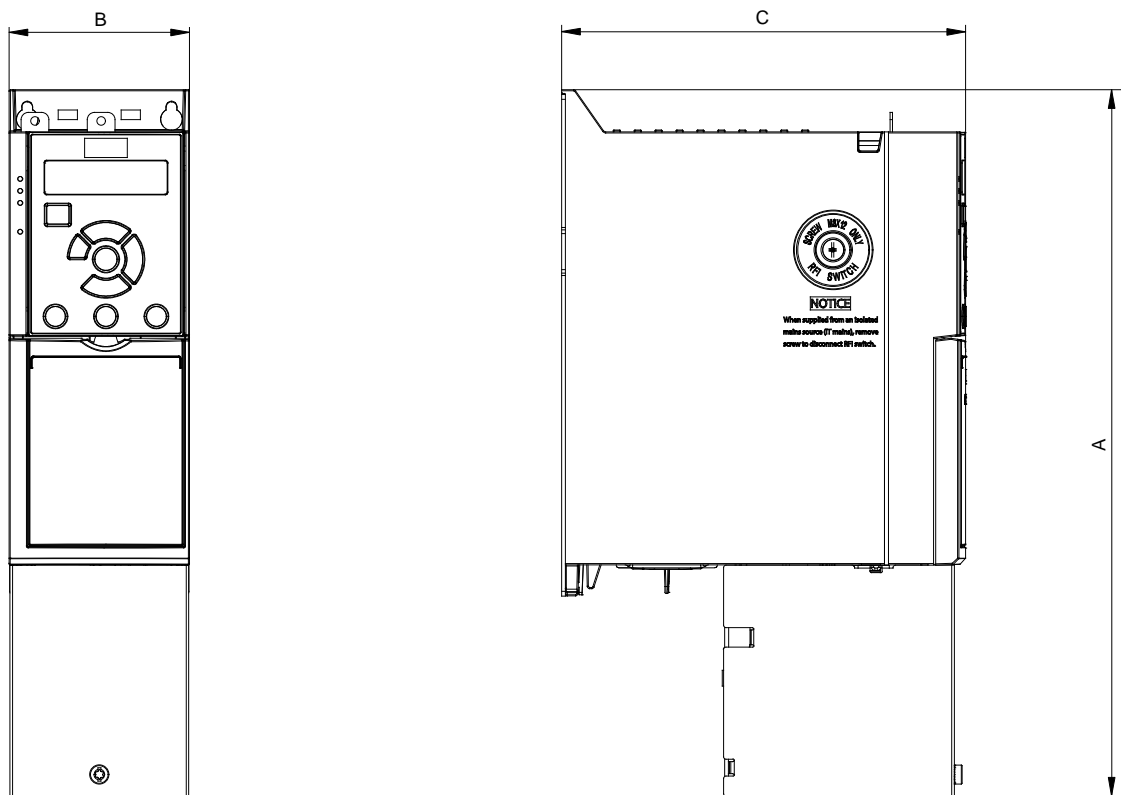

e30be846.10

Illustration 17: Standard with Bottom Cable Entry Cover (w/o Top Cover)

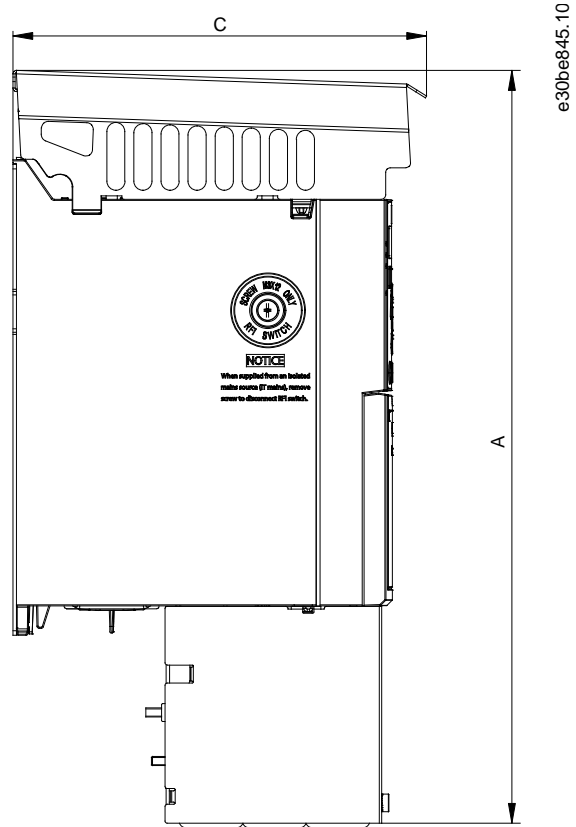
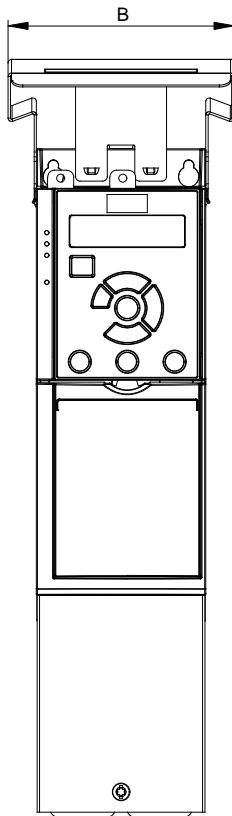

Illustration 18: Standard with IP21/UL/Type 1 kit

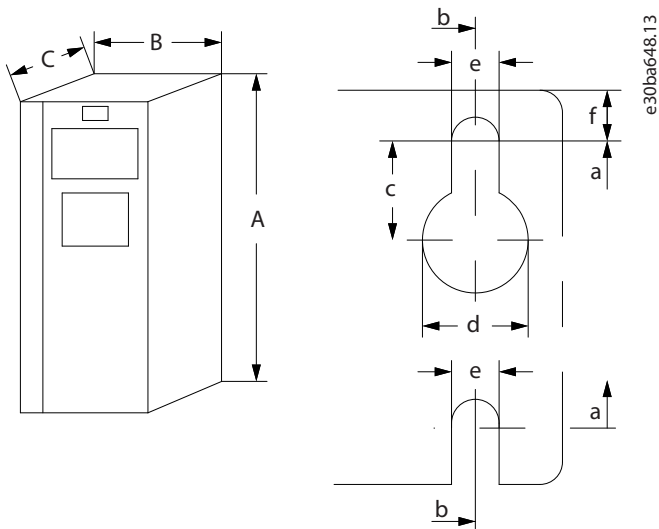

Illustration 19: Top and Bottom Mounting Holes

See [Table 3](#) to obtain dimensions and mounting hole measurements.

6 Selecting Accessories and Options for FC 280

6.1 Adapter Plate Accessories

Adapter plates facilitate the mounting assembly of the new VLT® Midi Drive FC 280 drive to replace the VLT® 2800 without the need to drill new mounting holes.

See [1.3 Additional Resources](#) for the instruction manual which provides information on mounting the adapter plates.

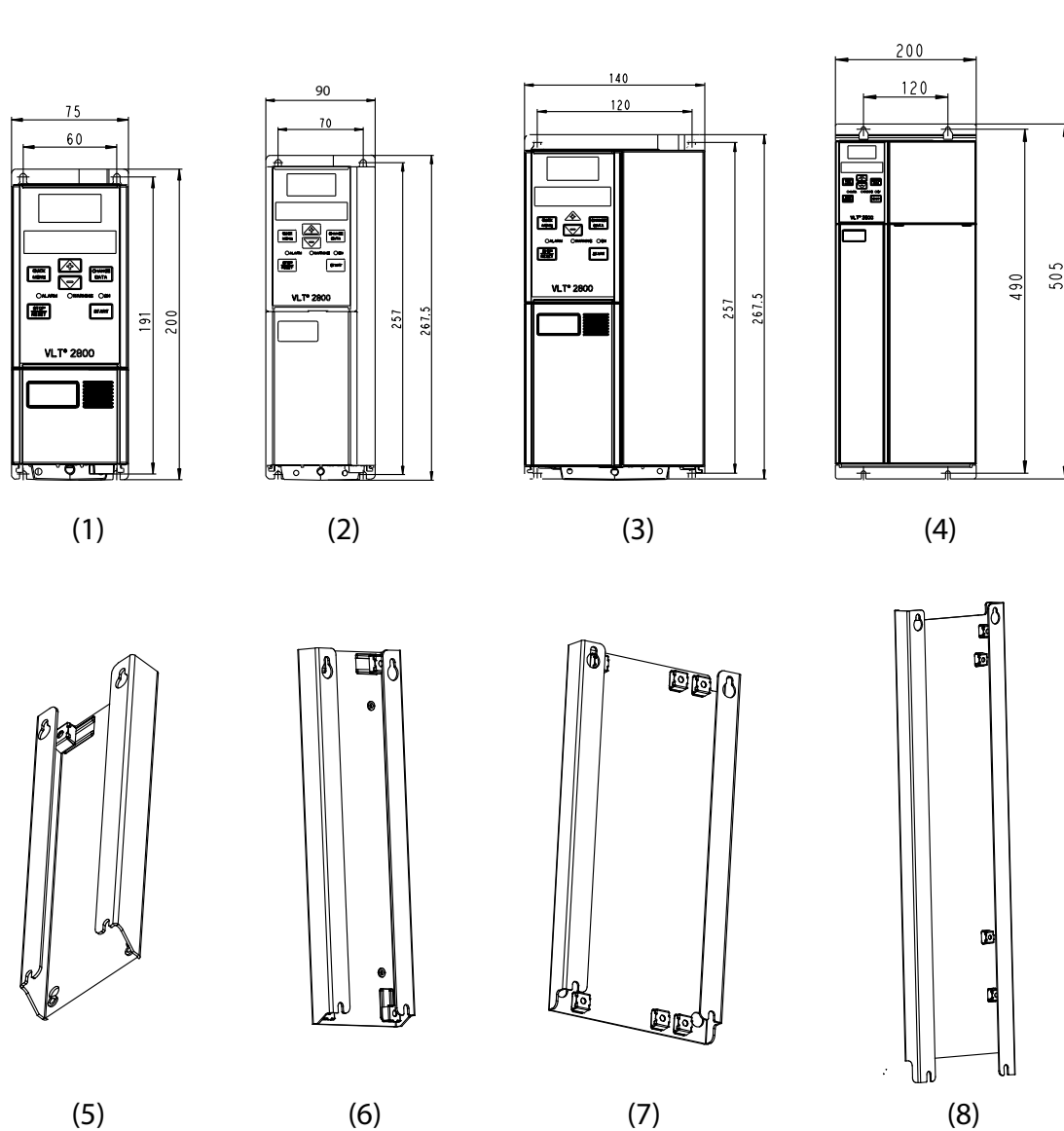

e30bj204.10

Illustration 20: VLT® 2800 Enclosure Sizes and Matching Adapter Plate to Order for Easy Conversion

1	VLT® 2800 enclosure size A	5	Adapter Plate, VLT® 2800 enclosure size A
2	VLT® 2800 enclosure size B	6	Adapter Plate, VLT® 2800 enclosure size B
3	VLT® 2800 enclosure size C	7	Adapter Plate, VLT® 2800 enclosure size C
4	VLT® 2800 enclosure size D	8	Adapter Plate, VLT® 2800 enclosure size D

Table 4: Adapter Plates with the Order Code

Order code	Adapter plates	VLT® 2800 type code character
132B0363	Adapter Plate, VLT® 2800 enclosure size A	VLT 2803-2815
132B0364	Adapter Plate, VLT® 2800 enclosure size B	VLT 2822-2840
132B0365	Adapter Plate, VLT® 2800 enclosure size C	VLT 2855-2875
132B0366	Adapter Plate, VLT® 2800 enclosure size D	VLT 2880-2882

6.2 VLT® Numeric Control Panel LCP 21

This panel is an alternative to the graphical display. This simpler and less expensive display does not need adapters to connect to the drive.



e30bj106.10

Illustration 21: VLT® Numeric Control Panel LCP 21 (Order Code 132B0254)

6.3 Graphic Display Option and LCP adapter for LCP 102

The LCP (Local Control Panel) is not integrated into the drive by default and must therefore be ordered separately.

To connect the LCP 102 Graphical Display to the VLT® Midi Drive FC 280, the following accessories are always needed with LCP 102 Graphical Display:

- Graphical LCP Adapter

The LCP 102 Graphical Display and LCP Adapter must be ordered separately. See [1.3 Additional Resources](#) for the LCP adapter installation instructions for detailed information.



Illustration 22: Graphical LCP Display (Order Code 132B1107)



Illustration 23: Graphical LCP Adapter for LCP 102 (Order Code 132B0281)

6.4 Memory Module and PROFIBUS Activation Emulator MCM 103

While replacing VLT® 2800 with VLT® Midi Drive FC 280, it is not possible to change the configuration parameters (GSD file) of the drives on the Master (PLC) of the fieldbus.

In this case, it is necessary to use the following option that Danfoss Drives offers for these drives to facilitate the retrofitting of the installed VLT® 2800 drive to VLT® Midi drive FC 280.

MCM 103 is used to activate the emulation function of the VLT® 2800 on the PROFIBUS network.



Illustration 24: MCM 103 (Order Code 132B0466)

Principle of operation

The control board transfers data between the drive and the memory module in both directions:

- VLT® Midi Drive FC 280 → MCM 103 to create a full backup of the drive (software and parameters).
- MCM 103 → VLT® Midi Drive FC 280 to activate the PROFIBUS emulation converter of the VLT® 2800 and to restore all data and programming of the drive.

See [1.3 Additional Resources](#) for the memory module installation instructions for detailed information.

6.5 Convert IP20 to IP21/Type 1 Conversion Kit Option

The conversion kit raises the degree of ingress protection (IP21/Type1) for VLT® Midi Drive FC 280.

See [1.3 Additional Resources](#) for the IP21/Type 1 Conversion Kit installation instructions.

Table 5: Conversion Ingress Protection Kits with the Order Code

Order Code	Kit per VLT® Midi Drive FC 280 Frame Size
132B0335	IP21/Type 1 conversion kit, K1
132B0336	IP21/Type 1 conversion kit, K2
132B0337	IP21/Type 1 conversion kit, K3
132B0338	IP21/Type 1 conversion kit, K4
132B0339	IP21/Type 1 conversion kit, K5

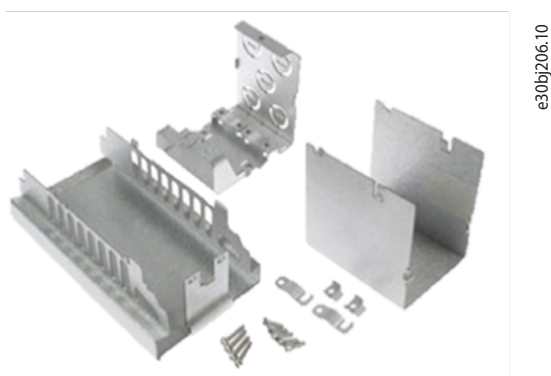

e30bj206.10

Illustration 25: IP 21/NEMA1/Type 1 Conversion Kit Components

Illustration 26: Drive with Conversion Kit Components

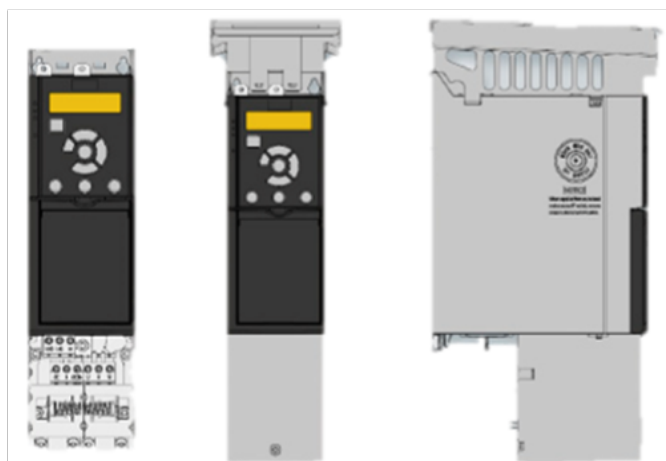

e30bj207.10

Easy and quick conversion from IP20 to IP21/Type 1:

- Ready-made conversion kit to ensure IP21/Type 1 protection class.
- Quick and easy to adapt.

6.6 Overview of Accessories

The following table shows the codes which are available to complete the range of accessories supporting VLT® Midi Drive FC 280 for full backward compatibility with VLT® 2800.

Table 6: Additional Components to Replace the Existing VLT® 2800

Order code	Material	Description
132B0254	VLT® Control Panel LCP 21 (NLCP)	Alphanumeric display not included with the drive.
132B0102	NLCP Remote Mounting Kit, w/3 m cable	Remote kit for display.
130B1107	VLT® Control Panel LCP 102 (GLCP)	Graphic display.
132B0281	Adapter, Graphical LCP	Required with graphic display.
130B1117	GLCP Remote Mounting Kit, w/3 m cable	Remote kit for graphic display.
132B0262	LCP blind cover, IP20/21	Closing cover without display.
132B0335	IP21/Type 1 conversion kit, K1	Kit for raising the degree of protection.
132B0336	IP21/Type 1 conversion kit, K2	Kit for raising the degree of protection.
132B0337	IP21/Type 1 conversion kit, K3	Kit for raising the degree of protection.
132B0338	IP21/Type 1 conversion kit, K4	Kit for raising the degree of protection
132B0339	IP21/Type 1 conversion kit, K5	Kit for raising the degree of protection.
132B0363	Adapter Plate, VLT® 2800 enclosure size A	Adapter plate with holes for VLT® 2800.
132B0364	Adapter Plate, VLT® 2800 enclosure size B	Adapter plate with holes for VLT® 2800.
132B0365	Adapter Plate, VLT® 2800 enclosure size C	Adapter plate with holes for VLT® 2800.
132B0366	Adapter Plate, VLT® 2800 enclosure size D	Adapter plate with holes for VLT® 2800.
132B0368	VLT® 24 V DC Supply MCB 106	External 24 V DC back-up power supply.
134B5463	MCC107A5K0T3U20BEB (0.37–2.2 kW/0.5-30 hp)	External filter for EMC compatibility H1.
134B5464	MCC107A12KT3U20BEB (3–5.5 kW/4-7.5 hp)	External filter for EMC compatibility H1.
134B5465	MCC107A16KT3U20BEB (7.5 kW/10 hp)	External filter for EMC compatibility H1.
132B0246	FN3258-30-47 (11–15 kW/15-20 hp)	External filter for EMC compatibility H1.
132B0247	FN3258-42-47 (18.5–22 kW/25-30 hp)	External filter for EMC compatibility H1.
134B5466	MCC107A11KS2U20BEB (0.37–1.5 kW/0.5-2.0 hp)	External filter for EMC compatibility H1.
134B5467	MCC107A15KS2U20BEB (2.2 kW/3 hp)	External filter for EMC compatibility H1.

6.7 Recommended Spare Parts

Table 7: Order Codes for Spare Parts

Order Code	Spare Part
132B0350	Accessory bag VLT® Midi Drive FC 280 terminal plugs
132B0351	Fan 50x20 IP21 PWM size K1
132B0352	Fan 60x20 IP21 PWM size K2
132B0353	Fan 70x20 IP21 PWM size K3
132B0371	Fan 92x38 IP21 PWM size K4

Order Code	Spare Part
132B0372	Fan 120x38 IP21 PWM size K5
132B0354	Terminal cover enclosure size K1
132B0355	Terminal cover enclosure size K2
132B0356	Terminal cover enclosure size K3
132B0357	Terminal cover enclosure size K4
132B0358	Terminal cover enclosure size K5
132B0369	Bus cable decoupling kit, VLT® Midi Drive FC 280
132B0373	Decoupling kit, power I/O, K1
132B0374	Decoupling kit, power I/O, K2/K3
132B0375	Decoupling kit, power I/O, K4/K5

7 Mechanical Installation, Wiring, and Cable Connections

7.1 Mechanical Installation

All (IP20) VLT® Midi Drive FC 280 units can be installed side by side in vertical or horizontal position. The units do not require extra ventilation on the lateral side.

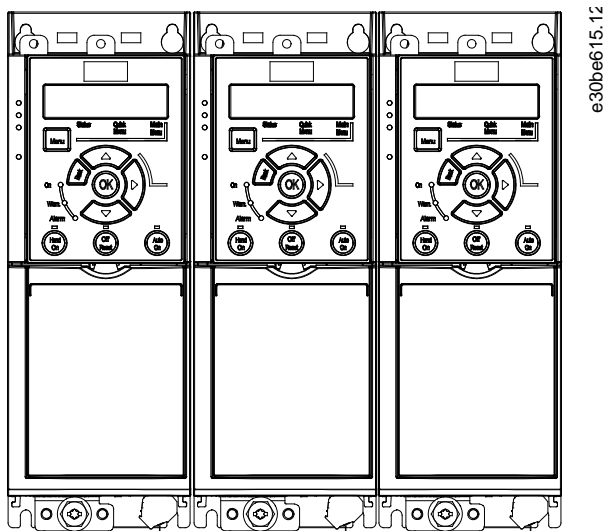

Illustration 27: IP20 Enclosure Mounting Side by Side

⚠ CAUTION ⚠

RISK OF OVERHEATING

If the IP21 solution is used, mounting the unit side by side could lead to overheating and unit damage.

- Avoid mounting the unit side by side if IP21 solution is used.

7.2 Electrical Installation

Recommended installation diagram for EMC considerations and wiring. Power terminal connectors can be reused between VLT® 2800/VLT® Midi Drive FC 280.

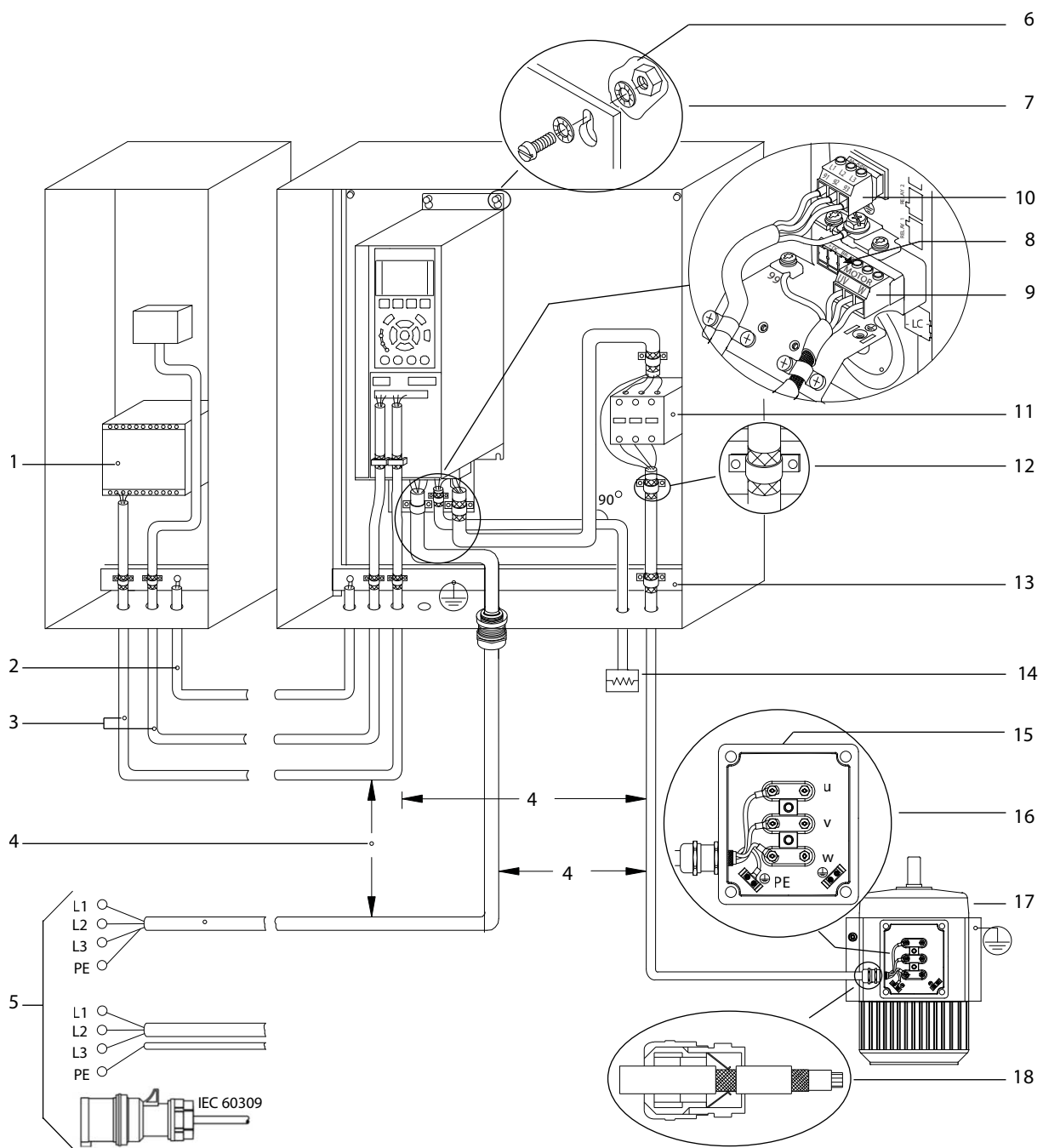

Illustration 28: Typical Electrical Connection

1	PLC	10	Mains cable (unshielded)
2	Minimum 16 mm ² (6 AWG) equalizing cable	11	Output contactor
3	Control cables	12	Cable insulation stripped
4	Minimum 200 mm (7.87 in) between control cables, motor cables, and mains cables.	13	Common ground busbar. Follow local and national requirements for cabinet grounding.
5	Mains supply	14	Brake resistor
6	Bare (unpainted) surface	15	Metal box
7	Star washers	16	Connection to motor
8	Brake cable (shielded)	17	Motor
9	Motor cable (shielded)	18	EMC cable gland

7.2.1 Grounding Principle for EMC-Compliant Installation

There is a risk of interference when there is a ground potential difference between the drive and the control system. Ensure a good electrical contact between the shield cable and the drive enclosure by using metal cable gland or using the clamps provided with the equipment.

- Use high-strand wire to reduce electrical interference.
- Do not use connections as shown in the following illustration A.
- Ground each unit separately as shown in the following illustration B.

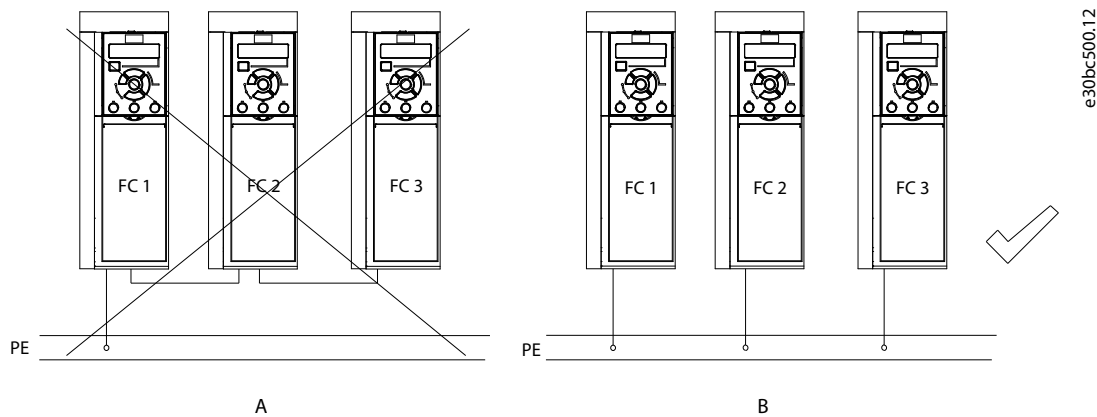

Illustration 29: Grounding Potential Equalization

7.2.2 Cable Specifications

Table 8: Cable Lengths

Maximum motor cable length, shielded	50 m (164 ft)
Maximum motor cable length, unshielded	75 m (246 ft)
Maximum cross-section of control terminals, flexible/rigid wire	2.5 mm ² /14 AWG
Minimum cross-section of control terminals	0.55 mm ² /30 AWG
Maximum STO input cable length, unshielded	20 m (66 ft)

For power cables cross-sections, see the VLT® Midi Drive FC 280 Operation Guide.

Design Guide

7.2.3 Connection Tightening Torques

Make sure to use the right torques when tightening all electrical connections.

⚠ CAUTION ⚠

ELECTRICAL CONNECTION ISSUES
Too low or too high torque sometimes causes electrical connection problems.

- To ensure that correct torques are applied, use a torque wrench.
- Recommended slot screwdriver type is SZ5 0.6x3.5 mm.

Table 9: Connection Tightening Torques

Enclosure type	Power [kW(hp)]	Torque [Nm (in-lb)]						
		Mains	Motor	DC connection	Brake	Ground	Control	Relay
K1	0.37–2.2 (0.5–3.0)	0.8 (7.1)	0.8 (7.1)	0.8 (7.1)	0.8 (7.1)	1.6 (14.2)	0.4 (3.5)	0.5 (4.4)
K2	3.0–5.5 (4.0–7.5)	0.8 (7.1)	0.8 (7.1)	0.8 (7.1)	0.8 (7.1)	1.6 (14.2)	0.4 (3.5)	0.5 (4.4)
K3	7.5 (10)	0.8 (7.1)	0.8 (7.1)	0.8 (7.1)	0.8 (7.1)	1.6 (14.2)	0.4 (3.5)	0.5 (4.4)
K4	11–15 (15–20)	1.2 (10.6)	1.2 (10.6)	1.2 (10.6)	1.2 (10.6)	1.6 (14.2)	0.4 (3.5)	0.5 (4.4)
K5	18.5–22 (25–30)	1.2 (10.6)	1.2 (10.6)	1.2 (10.6)	1.2 (10.6)	1.6 (14.2)	0.4 (3.5)	0.5 (4.4)

7.3 Motor Connection

⚠ WARNING ⚠

INDUCED VOLTAGE
Induced voltage from output motor cables that run together can charge equipment capacitors, even with the equipment turned off and locked out/tagged out. Failure to run output motor cables separately or to use shielded cables could result in death or serious injury.

- Run output motor cables separately or use shielded cables.
- Simultaneously lock out/tag out all the drives.

- Comply with local and national electrical codes for cable sizes. For maximum cable sizes, see *chapter Electrical Data* in the VLT® Midi Drive FC 280 Operating Guide.
- Follow motor manufacturer wiring requirements.
- Motor wiring knockouts or access panels are provided at the base of IP21/Type 1 units.
- Do not wire a starting or pole-changing device (for example, Dahlander motor or slip ring induction motor) between the drive and the motor.

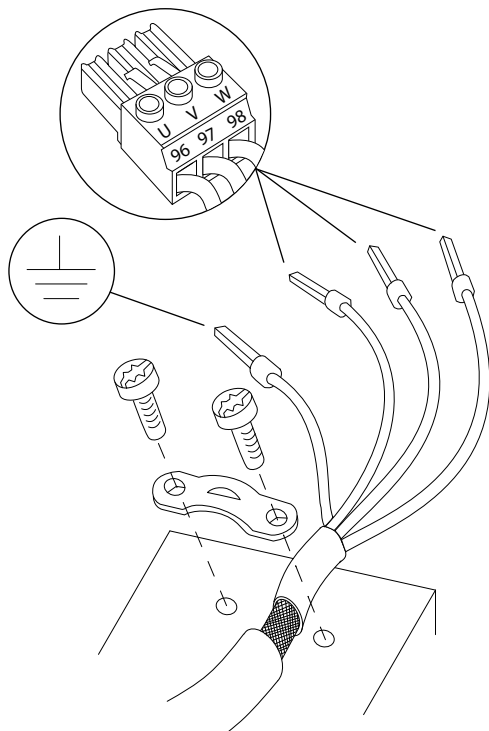

e30bd531.11

Illustration 30: Motor Connection

The mains, motor, and grounding connection for single-phase and 3-phase drives are shown in the following illustrations. Actual configurations vary with unit types and optional equipment.

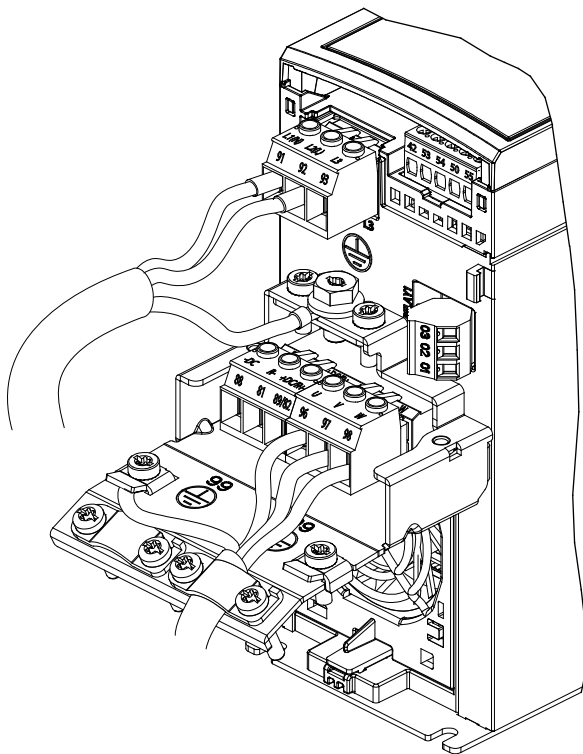

e30be232.11

Illustration 31: Example of Mains, Motor, and Grounding Connection for Single-phase Units (K1, K2)

Design Guide

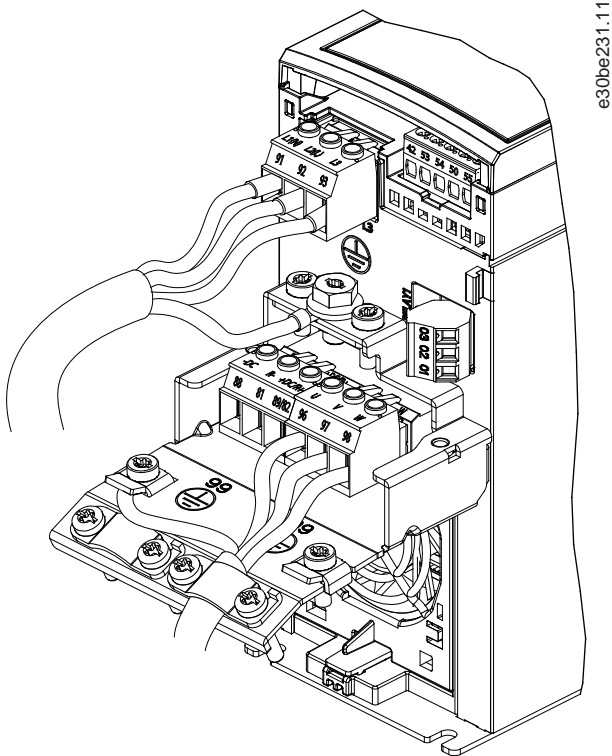

e30be231.11

Illustration 32: Example of Mains, Motor, and Grounding Connection for 3- phase Units (K1, K2, K3)

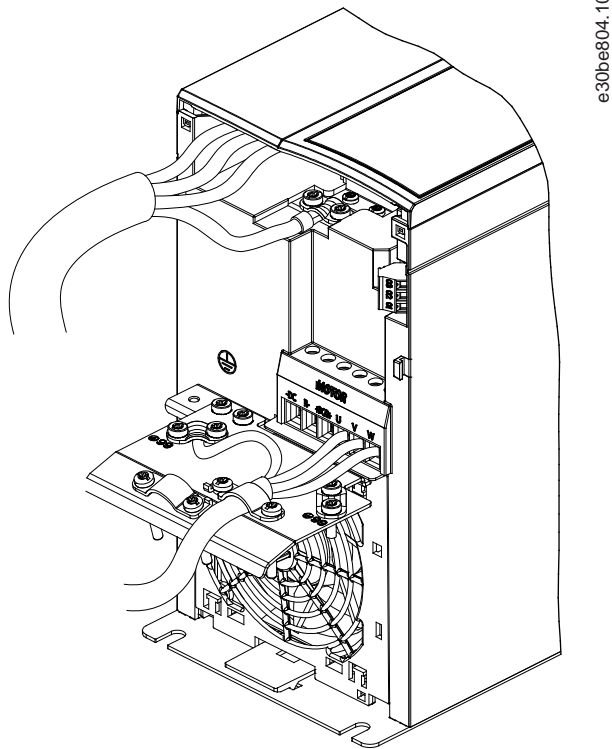

e30be804.1C

Illustration 33: Example of Mains, Motor, and Grounding Connection for 3- phase Units (K4, K5)

7.4 Terminal Comparison of I/O Control Wiring for VLT® Midi Drive FC 280

NOTICE

Safety-certified inputs 37 and 38 available only on the new drive must always be connected through a jumper to terminal 12 or 13 to allow motor to run.

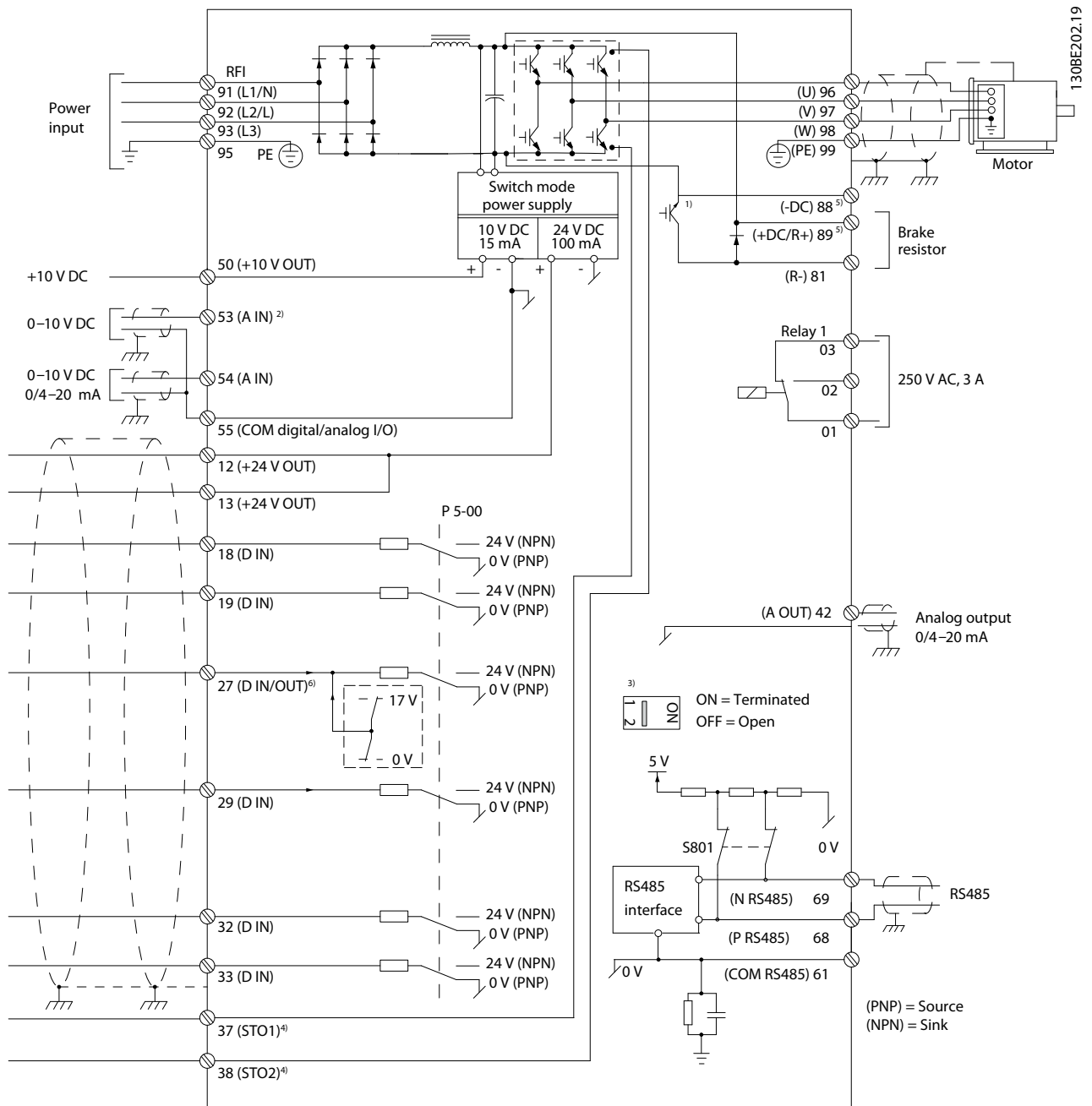

Illustration 34: Basic Wiring Schematic for VLT® Midi Drive FC 280

<p>A Analog</p> <p>D Digital</p> <p>1 Built-in brake chopper is only available on 3-phase units.</p> <p>2 Terminal 53 can also be used as digital input.</p>	<p>3 Switch S801 (bus terminal) can be used to enable termination on the RS485 port (terminals 68 and 69).</p> <p>4 Refer to <i>chapter Safe Torque Off (STO)</i> in the VLT® Midi Drive FC 280 Operating Guide for the correct STO wiring.</p> <p>5 The S2 (single-phase 200–240 V) drive does not support load sharing application.</p> <p>6 The maximum voltage is 17 V for terminal 27 as analog output.</p>
--	--

Design Guide

- All wiring must comply with local and national regulations regarding cross-section and ambient temperature requirements.
- Power connection wire recommendation shall be rated minimum 75 °C (167 °F) rated copper wire.
- See VLT® Midi Drive FC 280 Operating Guide for further information.

NOTICE

Keep control cables as short as possible and separate them from high-power cables to minimize interference

7.4.1 Terminal Descriptions for VLT® Midi Drive FC 280

Control terminal connectors can be unplugged from the drive for ease of installation.

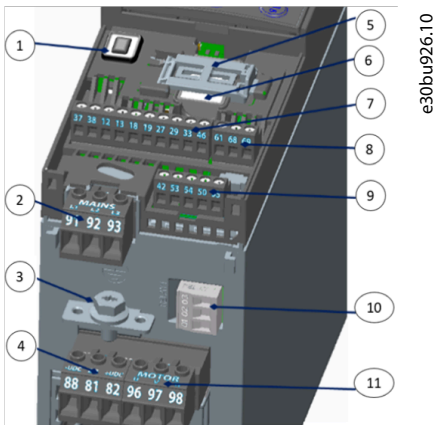

Illustration 35: Terminal Numbers

1	USB port	7	10 pin I/O plug
2	Mains plug	8	RS485 plug
3	Grounding	9	5 pin I/O plug
4	BR/UDC plug	10	Relay 1 plug
5	Memory lock	11	Motor plug
6	Memory module		

7.4.2 Terminal Descriptions and Parameter Group

Table 10: Mains and Motor Terminals

Terminal	Description
81	(-)R
82	(+)R
88	(-)DC
89	(+)DC
91	L1
92	L2
93	L3
95	PE

Terminal	Description
96	U
97	V
98	W
99	PE

Table 11: Terminal Descriptions

Terminal	Parameter	Default setting	Description
Digital I/O, pulse I/O, encoder			
12, 13	–	+24 V DC	24 V DC supply voltage. Maximum output current is 100 mA for all 24 V loads.
18	<i>Parameter 5-10 Terminal 18 Digital Input</i>	<i>[8] Start</i>	Digital inputs.
19	<i>Parameter 5-11 Terminal 19 Digital Input</i>	<i>[10] Reversing</i>	
27	<i>Parameter 5-01 Terminal 27 Mode, parameter 5-12 Terminal 27 Digital Input, parameter 5-30 Terminal 27 Digital Output</i>	DI [2] Coast inverse DO [0] No operation	Selectable for either digital input, digital output, or pulse output. The default setting is digital input.
29	<i>Parameter 5-13 Terminal 29 Digital Input</i>	<i>[14] Jog</i>	Digital input.
32	<i>Parameter 5-14 Terminal 32 Digital Input</i>	<i>[0] No operation</i>	Digital input, 24 V encoder. Terminal 33 can be used for pulse input.
33	<i>Parameter 5-15 Terminal 33 Digital Input</i>	<i>[0] No operation</i>	
37, 38	–	STO	Functional safety inputs.
Analog inputs/outputs			
42	<i>Parameter 6-91 Terminal 42 Analog Output</i>	<i>[0] No operation</i>	Programmable analog output. The analog signal is 0–20 mA or 4–20 mA at a maximum of 500 Ω. Can also be configured as digital outputs.
50	–	+10 V DC	10 V DC analog supply voltage. 15 mA maximum commonly used for potentiometer or thermistor.
53	<i>Parameter group 6-1* Analog Input 53</i>	–	Analog input. Only voltage mode is supported. It can also be used as digital input.
54	<i>Parameter group 6-2* Analog Input 54</i>	–	Analog input. Selectable between voltage or current mode.
55	–	–	Common for digital and analog inputs.
Serial communication			

Terminal	Parameter	Default setting	Description
61	–	–	Integrated RC filter for cable shield. ONLY for connecting the shield when experiencing EMC problems.
68 (+)	<i>Parameter group 8-3* FC Port Settings</i>	–	RS485 interface. A control card switch is provided for termination resistance.
69 (-)	<i>Parameter group 8-3* FC Port Settings</i>	–	
Relays			
01, 02, 03	<i>Parameter 5-40 Function Relay</i>	<i>[1] Control Ready</i>	Form C relay output. These relays are in various locations depending on the drive configuration and size. Usable for AC or DC voltage and resistive or inductive loads.

7.4.3 Terminal Function Comparison of Control Terminals for VLT® 2800 vs VLT® Midi Drive FC 280

Although the terminals for the control signals are not perfectly identical, the wiring terminal connections on the control board can be used to switch from the VLT® 2800 product to the VLT® Midi Drive FC 280 without having to change or add additional connections.

The power terminal connections for sizes up to 7.5 kW (10 hp) are present, they can be reused without unplugging as they are identical for the 2 series VLT® 2800 and VLT® Midi Drive FC 280. For larger enclosure sizes, the power cables are made directly to the respective terminals on the drive.

Table 12: Terminal Function Description of Control Terminals

Terminal number	VLT® 2800	VLT® Midi Drive FC 280	Note
01-03	Relay outputs	Relay outputs	Full compatibility.
12	Voltage 24 V DC	Voltage 24 V DC	Full compatibility.
13	N/A	Voltage 24 V DC	Full compatibility and additional function in addition to the VLT® 2800.
18–19	Programmable digital inputs	Programmable digital inputs	Full compatibility.
20	Ground for inputs and outputs	N/A	Missing but not essential, terminal 55 is used.
27	Digital input	Digital input or output (also usable as pulse train output)	Full compatibility and improved function compared to the VLT® 2800.
29	Digital input	Digital input or pulse train input	Full compatibility and improved function compared to the VLT® 2800.
32	N/A	Digital input or 24 V DC encoder input	Full compatibility and additional function in addition to the VLT® 2800.
33	Digital input (can be used as pulse train input)	Digital input or 24 V DC encoder input or pulse train input	Full compatibility and improved function compared to the VLT® 2800.
37–38	N/A	Dual-channel STO safety-certified input (PL.d/SIL2)	Full compatibility and additional function in addition to the VLT® 2800.
42	Analog current output	Analog current output or digital output	Full compatibility and improved function compared to the VLT® 2800.

Terminal number	VLT® 2800	VLT® Midi Drive FC 280	Note
50	Supply voltage +10 V DC for potentiometer or thermistor	Supply voltage +10 V DC for potentiometer or thermistor	Full compatibility.
53	Analog voltage input 0–10 V DC	Analog input in voltage or current	Full compatibility and improved function compared to the VLT® 2800.
54	N/A	Analog input in voltage or current	Full compatibility and additional function in addition to the VLT® 2800.
55	Ground for analog inputs and outputs	Common mass for inputs and outputs	Full compatibility.
60	Analog current input	N/A	Replaced by terminal 54.
61	N/A	RS485 bus termination terminal	Full compatibility and additional function in addition to the VLT® 2800.
67	Supply voltage + 5 V DC for PROFIBUS	N/A	+ 5 V DC terminal 67 is not required for conversion with PROFIBUS
68–69	RS485 serial communication	RS485 serial communication	Full compatibility.
70	Ground for terminals 67, 68 and 69	N/A	As a rule, the clamp is not used

7.5 Application Examples and Wiring for VLT® Midi Drive FC 280

The purpose of this chapter is a quick reference for ease of setting up some basic control wiring applications.

For detailed information on application and parameter settings and an example of process PID control, see further instructions in the VLT® Midi Drive FC 280 Operation Guide.

A jumper wire is required between terminal 12 (or 13) and terminal 27 for the drive to operate when using factory default programming values. See the VLT® Midi Drive FC 280 Operation Guide *chapter Enabling Motor Operation (Terminal 27)* for further information.

7.5.1 Application Examples

7.5.1.1 AMA

Table 13: AMA with T27 Connected

	Parameters	
	Function	Setting
	Parameter 1-29 Automatic Motor Adaptation (AMA)	[1] Enable complete AMA
	Parameter 5-12 Terminal 27 Digital Input	*[2] Coast inverse
	*=Default value	
	Notes/comments: Set parameter group 1-2* Motor Data according to motor specifications.	
	NOTICE	
	If terminals 13 and 27 are not connected, set parameter 5-12 Terminal 27 Digital Input to [0] No operation.	

7.5.1.2 Speed

Table 14: Analog Speed Reference (Voltage)

	Parameters	
	Function	Setting
	Parameter 6-10 Terminal 53 Low Voltage	*0.07 V
	Parameter 6-11 Terminal 53 High Voltage	*10 V
	Parameter 6-14 Terminal 53 Low Ref./Feedb. Value	0
	Parameter 6-15 Terminal 53 High Ref./Feedb. Value	50
	Parameter 6-19 Terminal 53 mode	[1] Voltage
	*=Default value	
	Notes/comments:	

Table 15: Analog Speed Reference (Current)

<p style="text-align: right;">e30bf097.10</p>	Parameters	
	Function	Setting
	<i>Parameter 6-22 Terminal 54 Low Current</i>	*4 mA
	<i>Parameter 6-23 Terminal 54 High Current</i>	*20 mA
	<i>Parameter 6-24 Terminal 54 Low Ref./Feedb. Value</i>	0
	<i>Parameter 6-25 Terminal 54 High Ref./Feedb. Value</i>	50
	<i>Parameter 6-29 Terminal 54 mode</i>	[0] Current
	* = Default value	
	Notes/comments:	

Table 16: Speed Reference (Using a Manual Potentiometer)

<p style="text-align: right;">e30be208.11</p>	Parameters	
	Function	Setting
	<i>Parameter 6-10 Terminal 53 Low Voltage</i>	*0.07 V
	<i>Parameter 6-11 Terminal 53 High Voltage</i>	*10 V
	<i>Parameter 6-14 Terminal 53 Low Ref./Feedb. Value</i>	0
	<i>Parameter 6-15 Terminal 53 High Ref./Feedb. Value</i>	50
	<i>Parameter 6-19 Terminal 53 mode</i>	[1] Voltage
	* = Default value	
	Notes/comments:	

Design Guide

Table 17: Speed Up/Speed Down

	Parameters	
	Function	Setting
	<i>Parameter 5-10 Terminal 18 Digital Input</i>	<i>*[8] Start</i>
	<i>Parameter 5-12 Terminal 27 Digital Input</i>	<i>[19] Freeze Reference</i>
	<i>Parameter 5-13 Terminal 29 Digital Input</i>	<i>[21] Speed Up</i>
	<i>Parameter 5-14 Terminal 32 Digital Input</i>	<i>[22] Speed Down</i>
	* = Default value	
Notes/comments:		

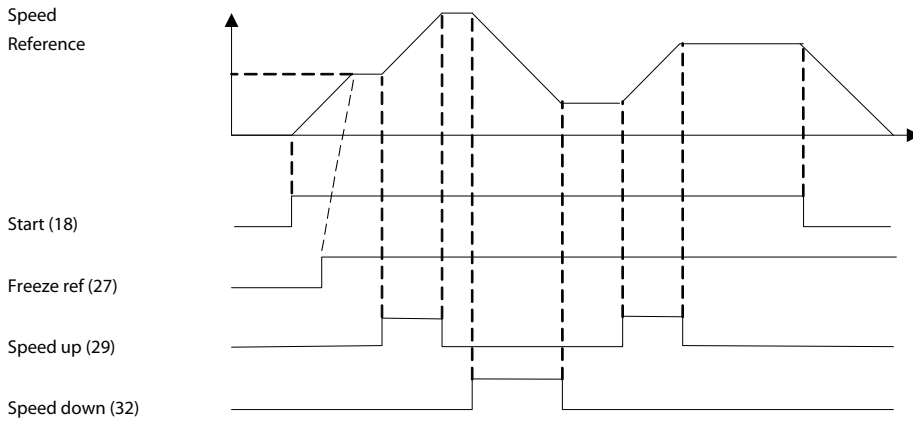

e30b840.12

Illustration 36: Speed Up/Speed Down

7.5.1.3 Start/Stop

Table 18: Start/Stop with Reversing and 4 Preset Speeds

	Parameters	
	Function	Setting
	Parameter 5-10 Terminal 18 Digital Input	[8] Start
	Parameter 5-11 Terminal 19 Digital Input	*[10] Reversing
	Parameter 5-12 Terminal 27 Digital Input	[0] No operation
	Parameter 5-14 Terminal 32 Digital Input	[16] Preset ref bit 0
	Parameter 5-15 Terminal 33 Digital Input	[17] Preset ref bit 1
	Parameter 3-10 Pre set Reference	25% Preset ref. 0 50% Preset ref. 1 75% Preset ref. 2 100% Preset ref. 3
	*=-Default value	
	Notes/comments:	

7.5.1.4 External Alarm Reset

Table 19: External Alarm Reset

	Parameters	
	Function	Setting
	Parameter 5-11 Terminal 19 Digital Input	[1] Reset
	*=-Default value	
Notes/comments:		

7.5.1.5 Motor Thermistor

Table 20: Motor Thermistor

	Parameters	
	Function	Setting
	Parameter 1-90 Motor Thermal Protection	[2] Thermistor trip
	Parameter 1-93 Thermistor Source	[1] Analog input 53
	Parameter 6-19 Terminal 53 mode	[1] Voltage
	*=Default value	
	Notes/comments: If only a warning is needed, set <i>parameter 1-90 Motor Thermal Protection</i> to [1] <i>Thermistor warning</i> .	
	NOTICE	
	To meet PELV insulation requirements, use reinforced or double insulation on the thermistors.	

7.5.1.6 SLC

Table 21: Using SLC to Set a Relay

	Parameters	
	Function	Setting
	Parameter 4-30 Motor Feedback Loss Function	[1] Warning
	Parameter 4-31 Motor Feedback Speed Error	50
	Parameter 4-32 Motor Feedback Loss Timeout	5 s
	Parameter 7-00 S speed PID Feedback Source	[1] 24 V encoder
	Parameter 5-70 Term 32/33 Pulses Per Revolution	*1024
	Parameter 13-00 SL Controller Mode	[1] On
	Parameter 13-01 Start Event	[19] Warning
	Parameter 13-02 Stop Event	[44] Reset key
	Parameter 13-10 Comparator Operand	[21] Warning no.
	Parameter 13-11 Comparator Operator	*[1]≈
	Parameter 13-12 Comparator Value	61
	Parameter 13-51 SL Controller Event	[22] Comparator 0
	Parameter 13-52 SL Controller Action	[32] Set digital out A low

<i>Parameter 5-40 Function Relay</i>	<i>[80] SL digital output A</i>
* = Default value	
<p>Notes/comments:</p> <p>If the limit in the feedback monitor is exceeded, <i>warning 61, feedback monitor</i> is issued. The SLC monitors <i>warning 61, feedback monitor</i>. If <i>warning 61, feedback monitor</i> becomes true, relay 1 is triggered.</p> <p>External equipment could indicate that service is required. If the feedback error goes below the limit again within 5 s, the drive continues, and the warning disappears. Relay 1 persists until [Off/Reset] is pressed.</p>	

7.5.1.7 Safe Torque Off (STO)

The Safe Torque Off (STO) function is a component in a safety control system. STO prevents the unit from generating the energy that is required to rotate the motor, thus ensuring safety in emergency situations.

The STO function is designed and approved suitable for the requirements of:

- IEC/EN 61508: SIL2
- IEC/EN 61800-5-2: SIL2
- IEC/EN 62061: SILCL of SIL2
- EN ISO 13849-1: Category 3 PL d

To achieve the required level of operational safety, select and apply the components in the safety control system appropriately. Before using STO, carry out a thorough risk analysis on the installation to determine whether the STO function and safety levels are appropriate and sufficient.

For more information on safe torque off (STO), see *chapter Safe Torque Off (STO)* in the VLT® Midi Drive FC 280 Operating Guide.

7.6 Fuses and Circuit Breakers

7.6.1 Introduction

Use fuses and/or circuit breakers on the supply side to protect service personnel and equipment from injuries and damage if there is component breakdown inside the drive (first fault).

Branch circuit protection

Protect all branch circuits in an installation, switchgear, and machines against short circuit and overcurrent according to national/international regulations.

N O T I C E

Integral solid-state short-circuit protection does not provide branch circuit protection. Provide branch circuit protection in accordance with the national and local rules and regulations.

⚠ W A R N I N G ⚠

PERSONAL INJURY AND EQUIPMENT DAMAGE RISK

Malfunction or failing to follow the recommendations may result in personal risk and damage to the drive and other equipment.

- Select fuses according to recommendations. Possible damages can be limited to be inside the drive.

7.6.2 Recommendation of Fuses

N O T I C E

EQUIPMENT DAMAGE

Failure to follow the protection recommendations can result in damage to the drive.

- Using fuses and/or circuit breakers is mandatory to ensure compliance with IEC 60364 for CE.

Design Guide

Danfoss recommends using the fuses and circuit breakers in the following tables to ensure compliance with UL 508C or IEC 61800-5-1. For non-UL applications, design circuit breakers for protection in a circuit capable of delivering a maximum of 50000 A_{rms} (symmetrical), 240 V/400 V maximum. The drive short-circuit current rating (SCCR) is suitable for use on a circuit capable of delivering not more than 100000 A_{rms}, 240 V/480 V maximum when protected by Class T fuses.

The following tables list the recommended fuses that have been tested.

Table 22: Non-UL Fuse and Circuit Breaker

Enclosure size		Power [kW (hp)]	Non-UL fuse	Non-UL circuit breaker (Eaton)
3-phase 380–480 V	K1	0.37 (0.5)	gG-10	PKZM0-16
		0.55–0.75 (0.75–1.0)		
		1.1–1.5 (1.5–2.0)	gG-20	
		2.2 (3.0)		
	K2	3.0–5.5 (4.0–7.5)	gG-25	PKZM0-20
	K3	7.5 (10)		PKZM0-25
	K4	11–15 (15–20)	gG-50	–
K5	18.5–22 (25–30)	gG-80	–	
3-phase 200–240 V	K1	0.37 (0.5)	gG-10	PKZM0-16
		0.55 (0.75)	gG-20	
		0.75 (1.0)		
		1.1 (1.5)		
		1.5 (2.0)		
	K2	2.2 (3.0)	gG-25	PKZM0-20
	K3	3.7 (5.0)		PKZM0-25
Single-phase 200–240 V	K1	0.37 (0.5)	gG-10	PKZM0-16
		0.55 (0.75)	gG-20	
		0.75 (1.0)		
		1.1 (1.5)		
		1.5 (2.0)		
	K2	2.2 (3.0)	gG-25	PKZM0-20

Table 23: UL fuse

Enclosure size		Power [kW (hp)]	Bussmann E4273						Littel-fuse E81895	MERSEN E163267/E2137	MERSEN E163267/E2138
			Class RK1	Class J	Class T	Class CC	Class CC	Class CC	Class RK1	Class CC	Class RK1
3-phase 380–480 V	K1	0.37–0.75 (0.5–1.0)	KTS-R-6	JKS-6	JJS-6	FNQ-R-6	KTK-R-6	LP-CC-6	KLSR-6	ATM-R6	A6K-6R

		1.1–1.5 (1.5–2.0)	KTS-R-10	JKS-10	JJS-10	FNQ-R-10	KTK-R-10	LP-CC-10	KLSR-10	ATM-R10	A6K-10R
		2.2 (3.0)	KTS-R-15	JKS-15	JJS-15	FNQ-R-15	KTK-R-15	LP-CC-15	KLSR-15	ATM-R15	A6K-15R
	K2–K3	3.0–7.5 (4.0–10)	KTS-R-25	JKS-25	JJS-25	FNQ-R-25	KTK-R-25	LP-CC-25	KLSR-25	ATM-R25	A6K-25R
	K4	11–15 (15–20)	KTS-R-50	JKS-50	JJS-50	–	–	–	KLSR-50	–	A6K-50R
	K5	18.5–22 (25–30)	–	JKS-80	JJS-80	–	–	–	–	–	–
3-phase 200–240 V	K1	0.37 (0.5)	KTN-R-6	JKS-6	JJN-6	FNQ-R-6	KTK-R-6	LP-CC-6	KLNR-6	ATM-R6	A2K-6R
		0.55 (0.75)	KTN-R-10	JKS-10	JJN-10	FNQ-R-10	KTK-R-10	LP-CC-10	KLNR-10	ATM-R10	A2K-10R
		0.75 (1.0)	KTN-R-15	JKS-15	JJN-15	FNQ-R-15	KTK-R-15	LP-CC-15	KLNR-15	ATM-R15	A2K-15R
		1.1–1.5 (1.5–2.0)	KTN-R-20	JKS-20	JJN-20	FNQ-R-20	KTK-R-20	LP-CC-20	KLNR-20	ATM-R20	A2K-20R
	K2–K3	2.2–3.7 (3.0–5.0)	KTN-R-25	JKS-25	JJN-25	–	–	–	KLNR-25	ATM-R25	A2K-25R
Single-phase 200–240 V	K1	0.37 (0.5)	KTN-R-6	JKS-6	JJN-6	FNQ-R-6	KTK-R-6	LP-CC-6	KLNR-6	ATM-R6	A2K-6R
		0.55 (0.75)	KTN-R-10	JKS-10	JJN-10	FNQ-R-10	KTK-R-10	LP-CC-10	KLNR-10	ATM-R10	A2K-10R
		0.75 (1.0)	KTN-R-15	JKS-15	JJN-15	FNQ-R-15	KTK-R-15	LP-CC-15	KLNR-15	ATM-R15	A2K-15R
		1.1–1.5 (1.5–2.0)	KTN-R-20	JKS-20	JJN-20	FNQ-R-20	KTK-R-20	LP-CC-20	KLNR-20	ATM-R20	A2K-20R
	K2	2.2 (3.0)	KTN-R-25	JKS-25	JJN-25	–	–	–	KLNR-25	ATM-R25	A2K-25R

8 Parameter Conversion Programming

8.1 Introduction

To convert the new parameter setup from VLT® 2800 to VLT® Midi Drive FC 280, it is advisable to use the automated conversion function and programming software tool VLT® Motion Control Tool MCT 10.

NOTICE

- Link to download the latest available version of the MCT 10 software: <https://www.danfoss.com/en/service-and-support/downloads/dds/vlt-motion-control-tool-mct-10/>.
- Following section gives an overview of the use of VLT® Motion Control Tool MCT 10. See [1.3 Additional Resources](#) for more detailed information and instruction in the VLT® Midi Drive FC 280 Operating Guide.

8.2 Parameters Conversion Process

1. Go to: <https://www.danfoss.com/en/service-and-support/downloads/dds/vlt-motion-control-tool-mct-10/>.
2. Select *Open MyDrive® Suite*.

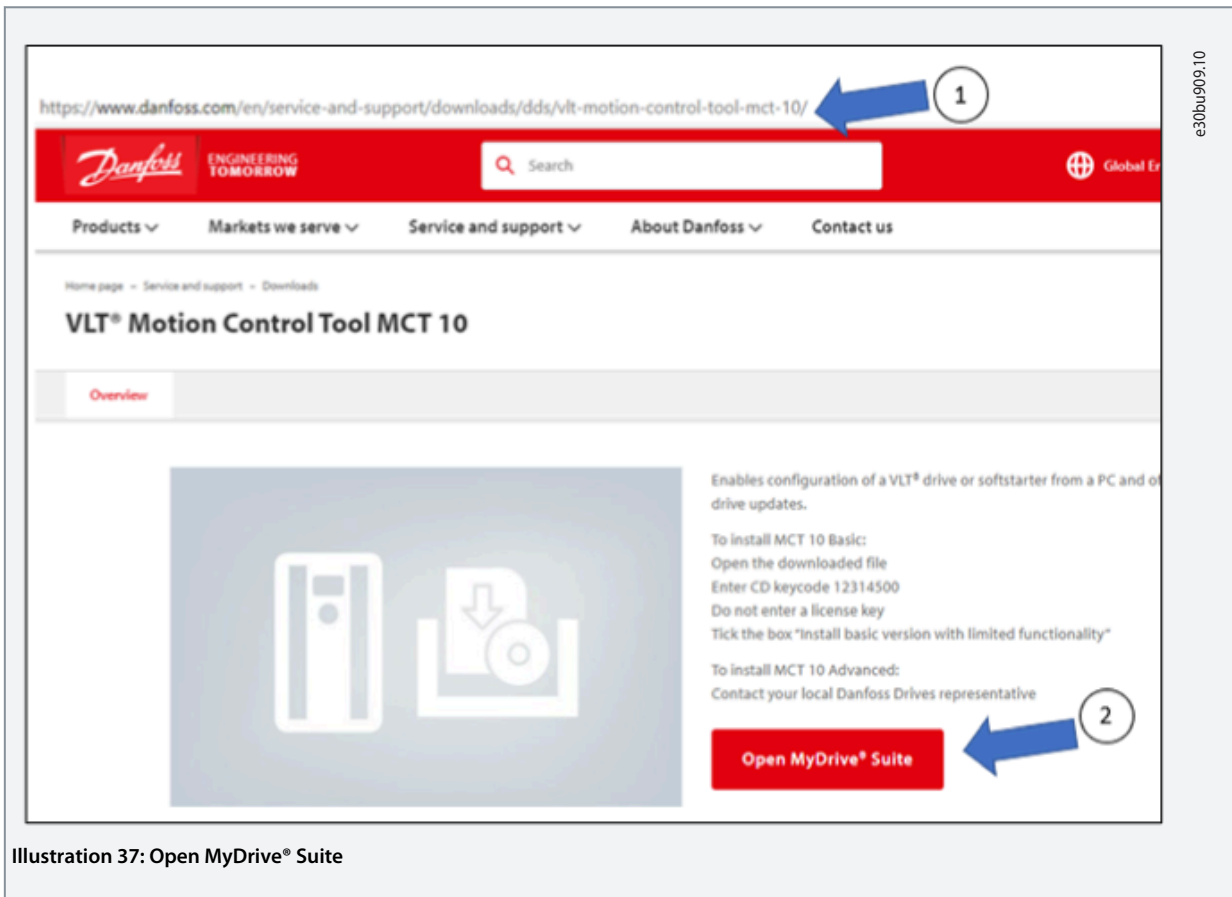

Illustration 37: Open MyDrive® Suite

3. Copy the CD keycode for the basic version download.

- Select *GET* to download the latest available version of the VLT® Motion Control Tool MCT 10.

VLT® Motion Control Tool MCT 10

OVERVIEW RELEASE NOTES

Enables configuration of a VLT® drive or softstarter from a PC and offers drive updates. Also Includes functionality for drive firmware update and configuration of functional safety using the safe plugin.
Basic version is free. To upgrade to Advanced version, please purchase the license key online via our authorized reseller FastSpring.
To install MCT 10 Basic:
Open the downloaded file
Enter CD keycode 12314500
Do not enter a license key
Tick the box Install "basic version with limited functionality."

5.60 GET BUY LICENSE

Illustration 38: Copy CD keycode

- Enter the CD keycode.
- Add a checkmark by *Install basic Version With Limited Functionality* and select *Next*.

CD Key and License Key

Please enter CD key and License key.

If your have purchased a CD version of MCT 10, the CD Cover contains a sticker with a License Key. Please uncheck the "Install Basic Version With Limited Functionality" check Box and enter the License key.

CD Key :

License Key :

Install Basic Version With Limited Functionality

Illustration 39: Enter CD code

Design Guide

- 7. Select *Complete* and follow the instructions until the download is completed.

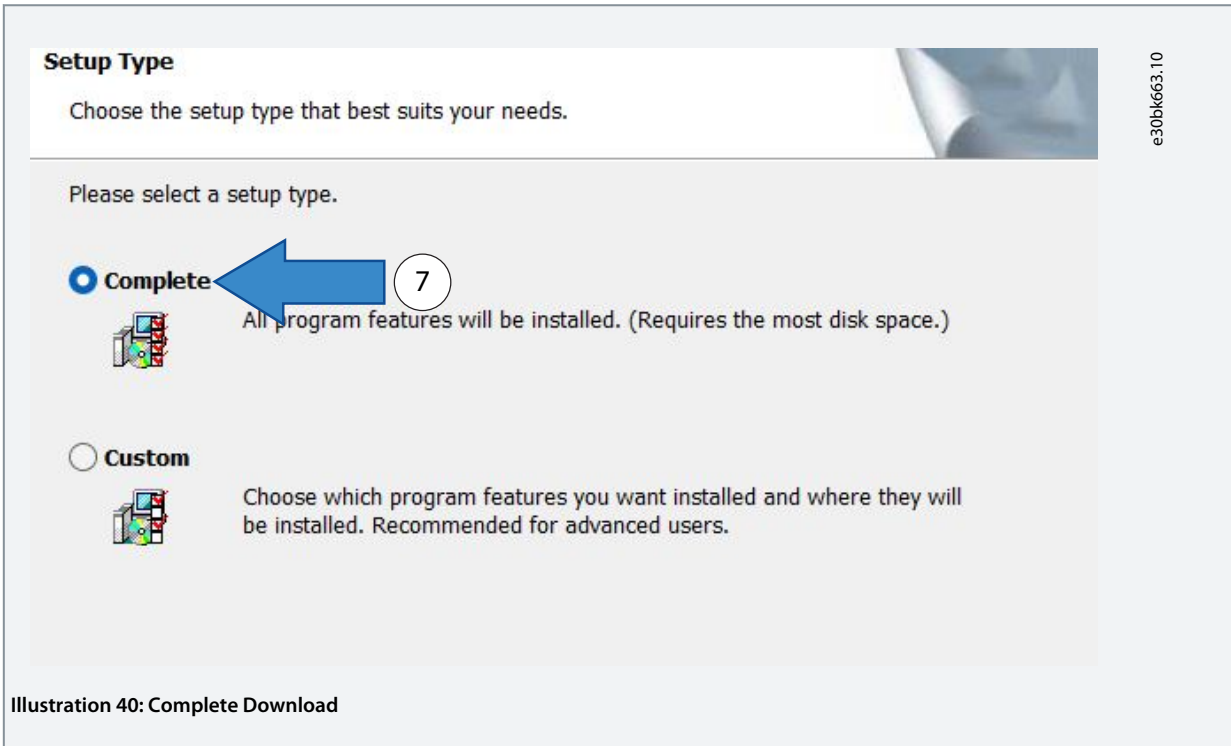

Illustration 40: Complete Download

- 8. Create a backup file of parameters of the VLT® 2800, which must be converted with the MCT 10 tool.

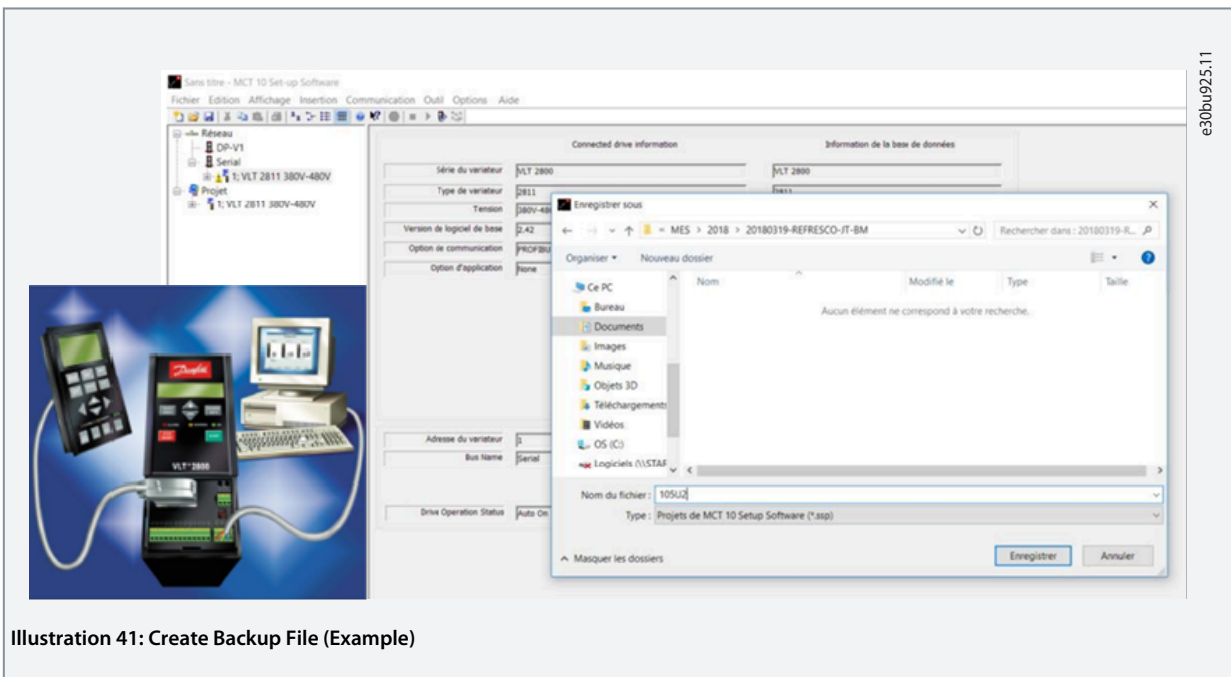

Illustration 41: Create Backup File (Example)

- Copy and paste the backup file program into *Project* and save it *File Save As*.

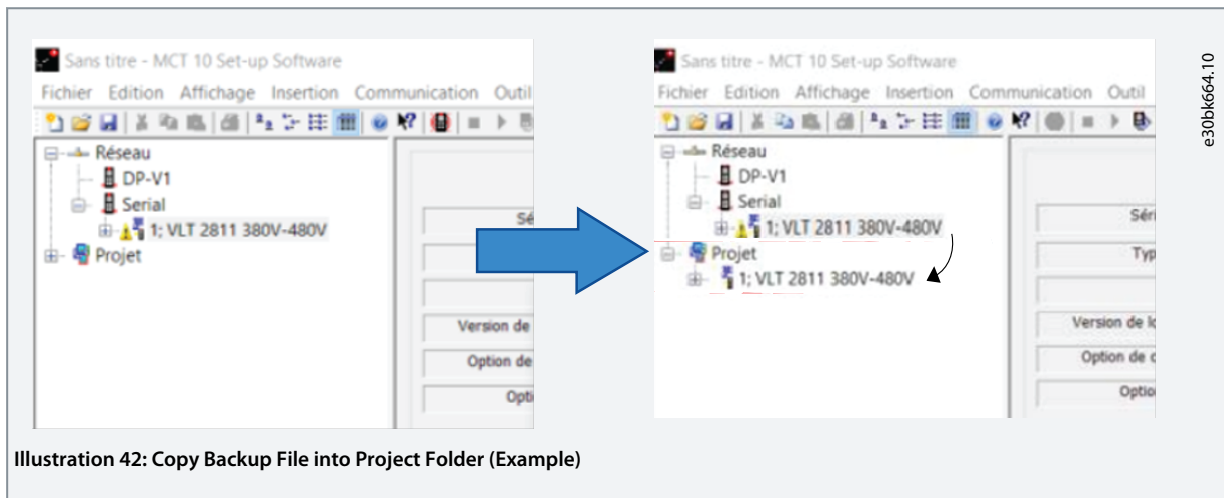

Illustration 42: Copy Backup File into Project Folder (Example)

- Select the *VLT® 2800 Conversion Wizard* option from the *Tools* tab option.

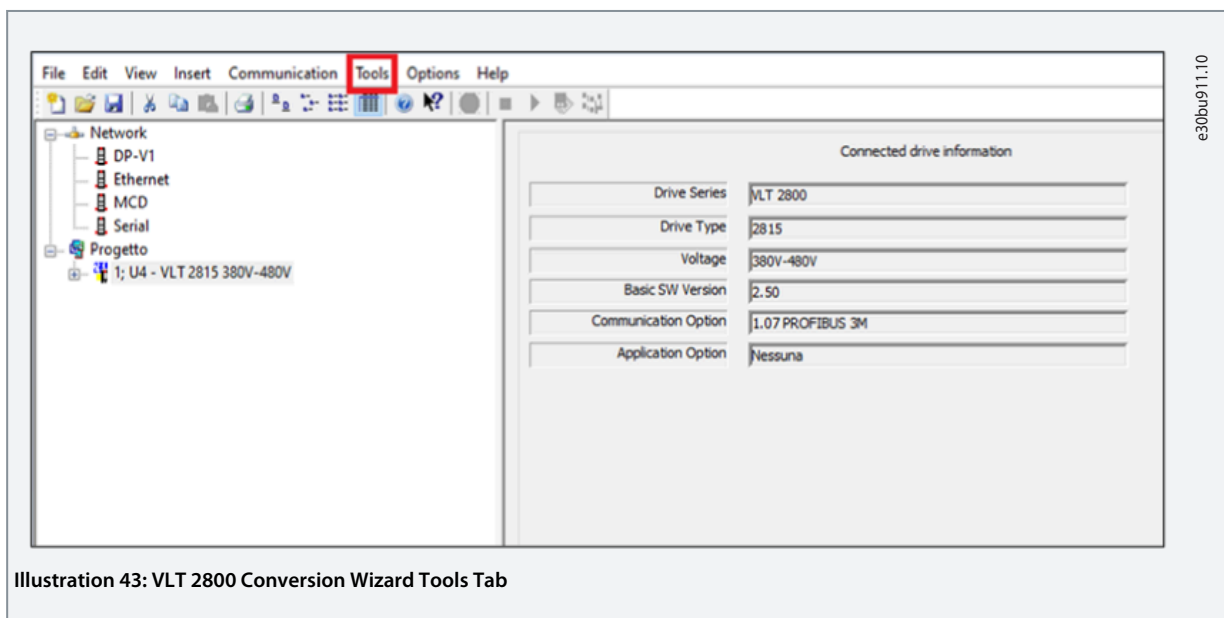

Illustration 43: VLT 2800 Conversion Wizard Tools Tab

11. Select *VLT® 2800* from the drop-down list under the Project folder and the *VLT 2800 Conversion Wizard* option from the *Tools* tab option.

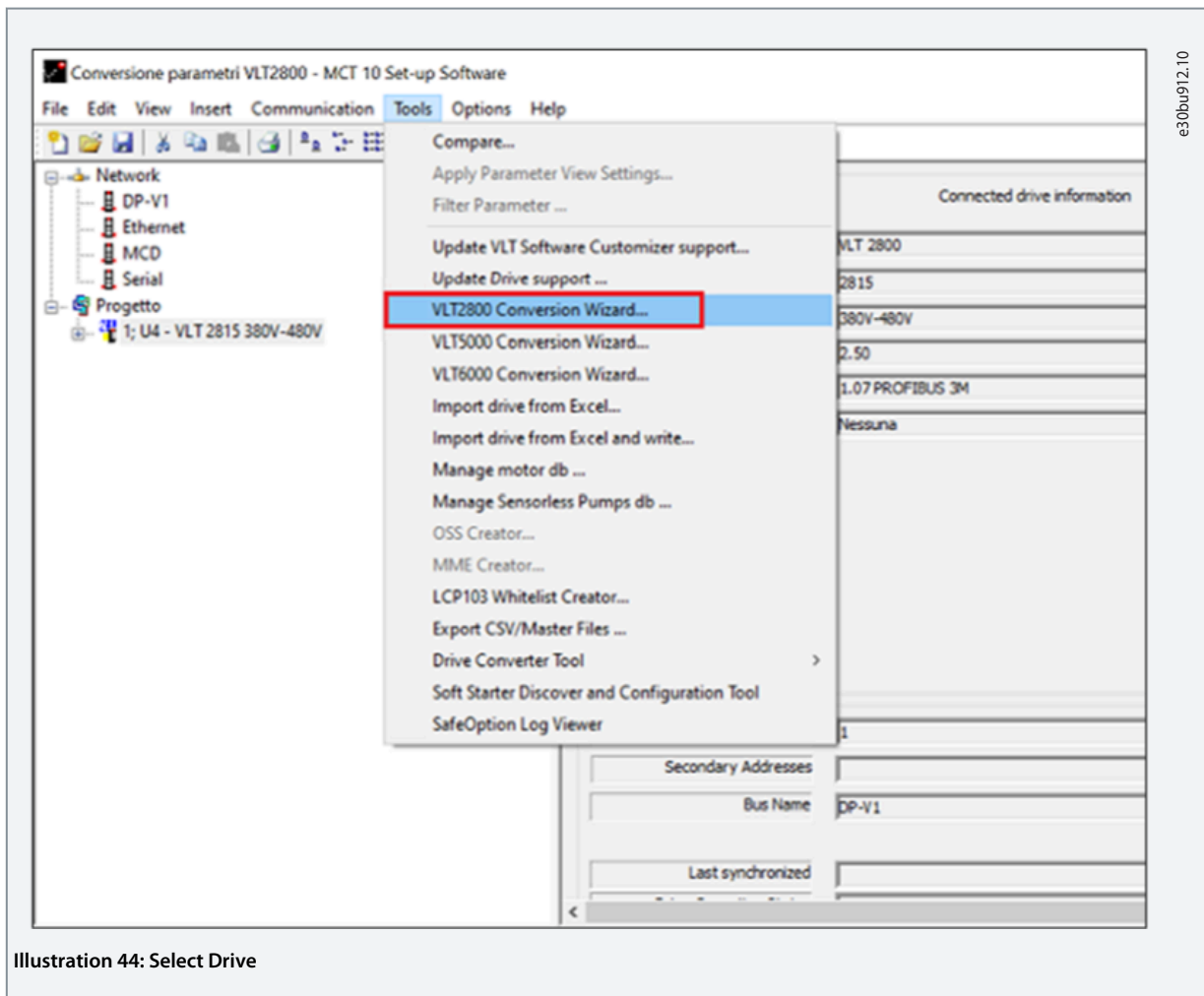

Illustration 44: Select Drive

- 12. Select the VLT® 2800 drive to convert and click *Next*.

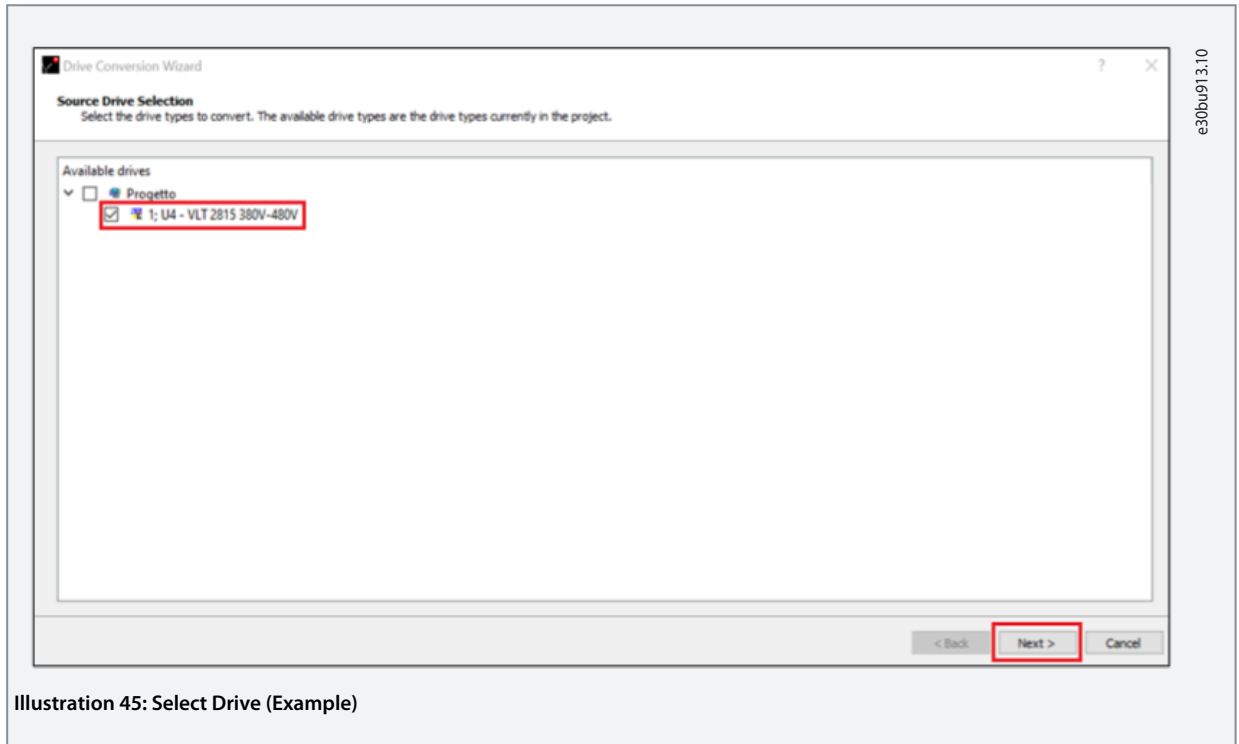

Illustration 45: Select Drive (Example)

- 13. Continue to click *Next* when prompted as shown in the following windows.

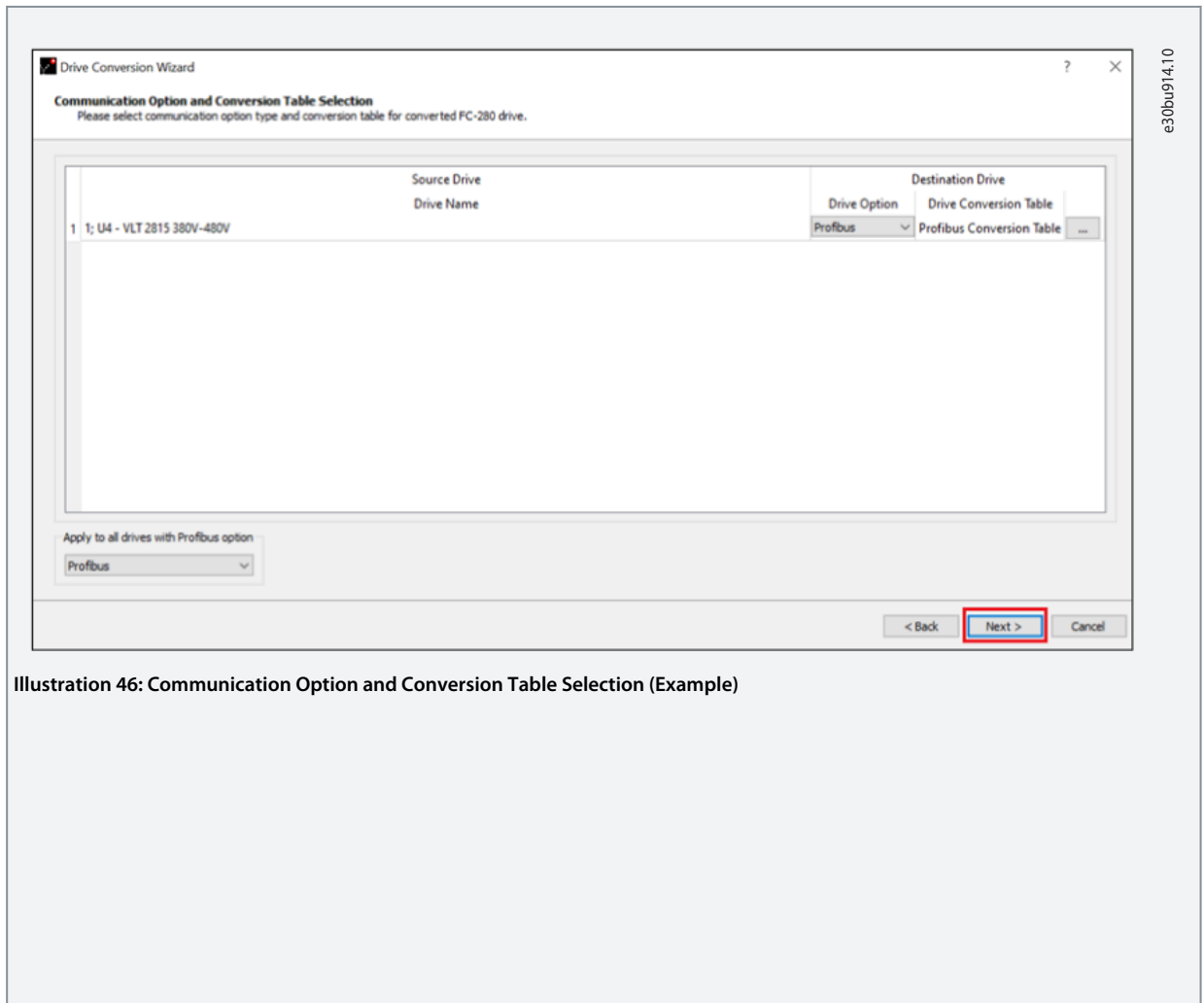

Illustration 46: Communication Option and Conversion Table Selection (Example)

Attention!
Please verify the drive conversion for your application!

The conversion is not guaranteed to be 100% correct in all applications. Especially the option parameters must be verified, since they are not part of the conversion. Please make a printout of the parameters with the selection "changed from factory default" in order to see what parameters are changed from default.

Relay Card is not supported by the converter.
Closed Loop applications are not supported by the converter.

Show this message every time

< Back **Next >** Cancel

Create new drives.
Specify FC-280 drives here.

Source Drive		Destination Drive								
Drive Name	Drive Name	Power Size	Voltage	Software version	Option A	Option B	Option C0	Option C1	Fieldbus	Ad
1; U4 - VLT 2815 380V-480V	1; U4 - VLT 2815 380V-480V (Converted)	1.50KW	380V-480V 3P	01.80	Profibus				DP-V1	5

Apply to all drives
Power Size Voltage Software version Fieldbus

Legend
 Address is in use in the project Recommended value

< Back **OK** Cancel

e30bu915.10
e30bu916.10

14. The conversion process now begins to run. Once it is completed, click *Finish*.



e30bu917.10

Illustration 47: Conversion Process in Progress (Example)

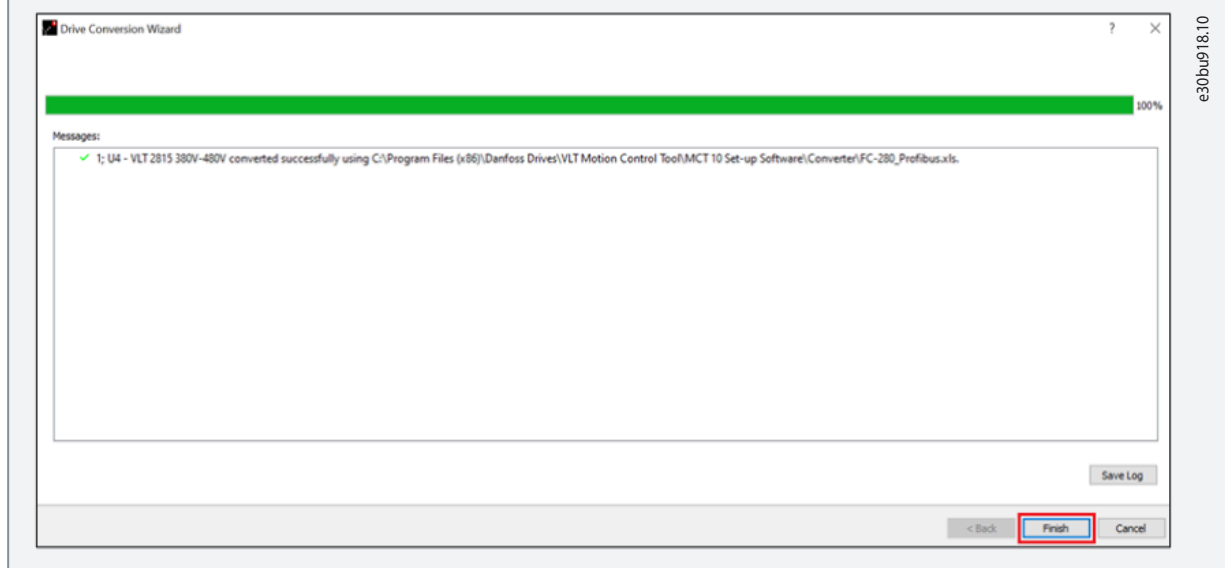

e30bu918.10

- When completed a new folder appears with the name of the drive followed by *converted*.

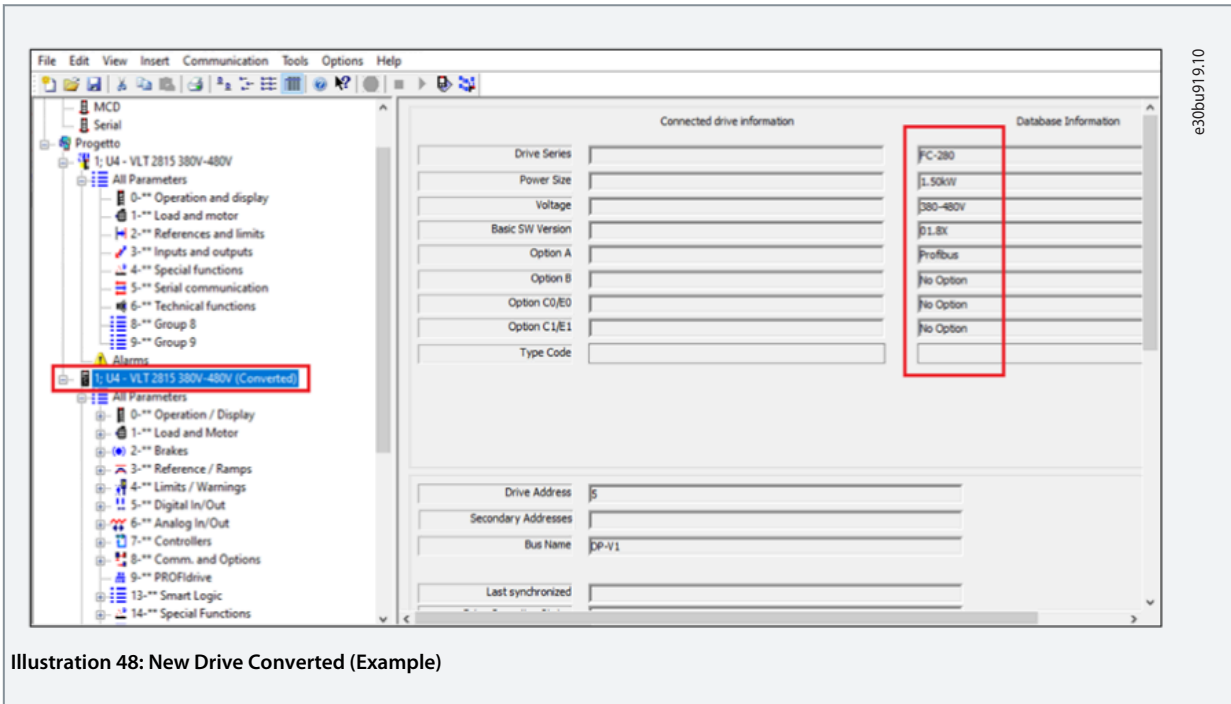

Illustration 48: New Drive Converted (Example)

- The only parameters, which must be manually verified, are related to the communication through fieldbus.

See [8.3 Corresponding Parameter Groups](#) and section [1.3 Additional Resources](#) for more information. See [9 Integration with the Existing PROFIBUS Communication](#) for proper set setting.

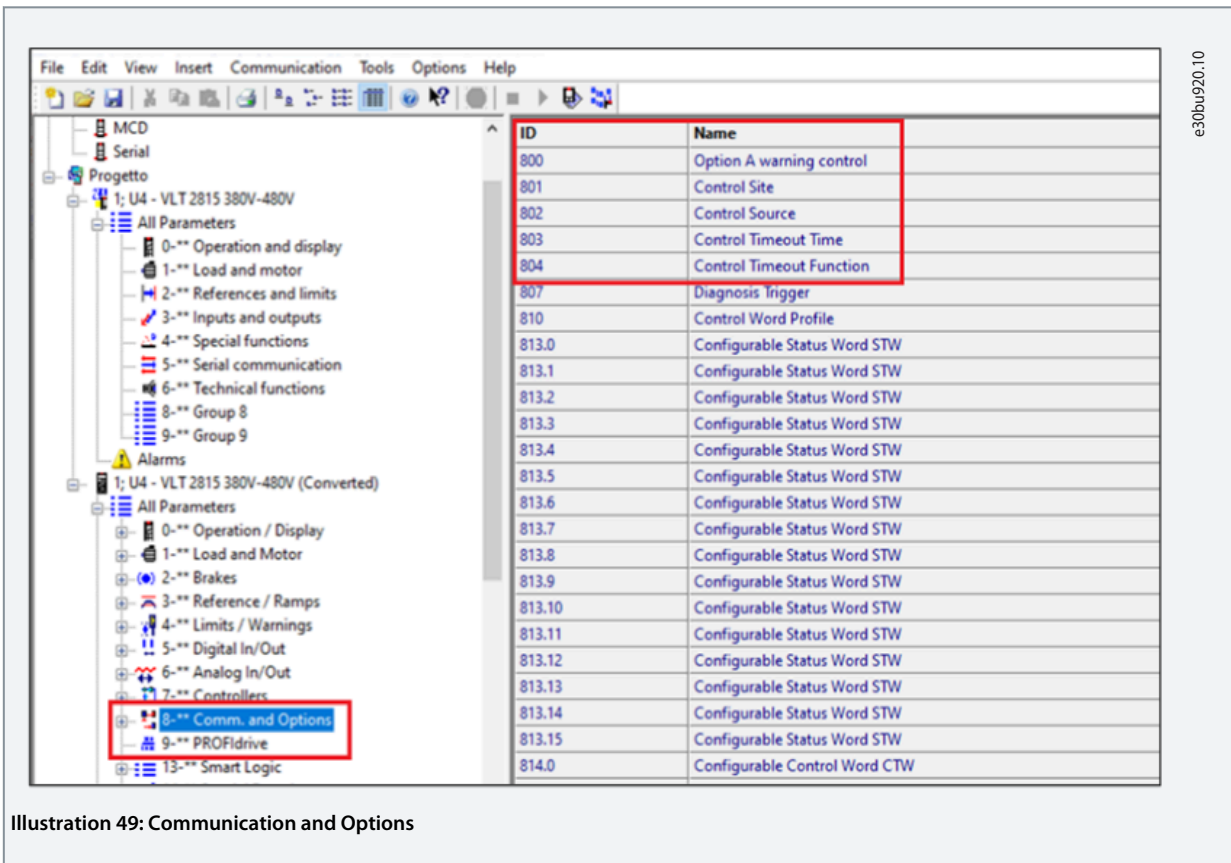

Illustration 49: Communication and Options

- Once the process has been executed, a new programming file for the new FC 280 replacement of the VLT® 2800 appears in the project. The programming file can be downloaded directly onto the FC 280 drive.

- Assign the fieldbus address to the unit (if communication option is present) through DIP switches present on the control cassette or with the LCP display by setting *parameter 9–18 Node Address*.

Illustration 50: Assign Fieldbus address

1	DIP switches
2	MAC address

- Connect the VLT® Midi drive FC280 to MCT 10 via the USB interface.

Make sure that *USB 1* port is selected in *connection* in the properties of the converted program.

Illustration 51: Connect via USB Interface (Example)

Design Guide

20. The drive is identified by the MCT 10 automatically, when the USB cable is connected. No special setting is needed.

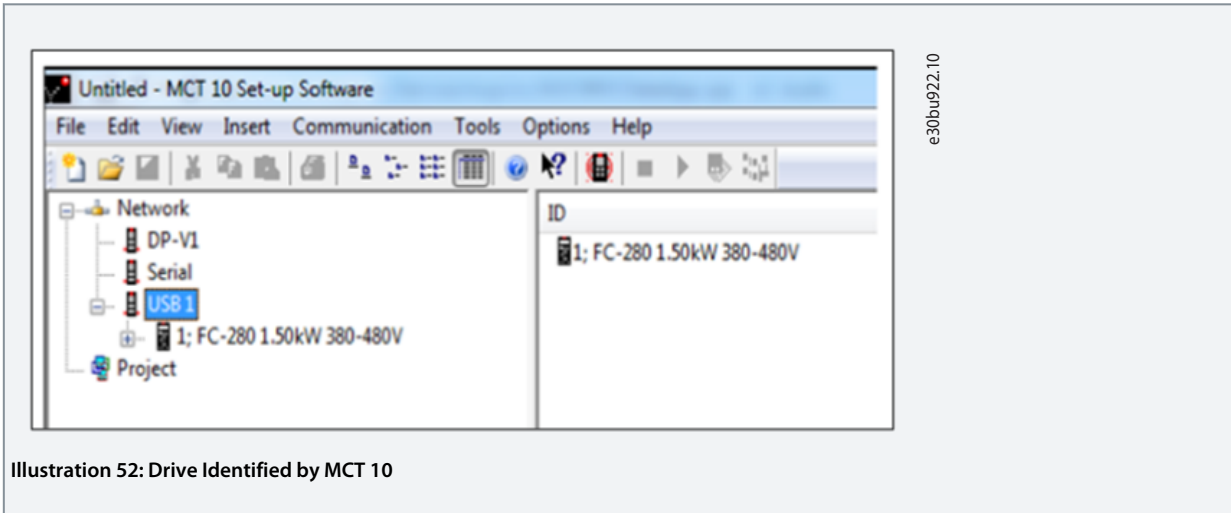

Illustration 52: Drive Identified by MCT 10

21. Right-click the converted drive, and select *Write to Drive* from the pop-up window.

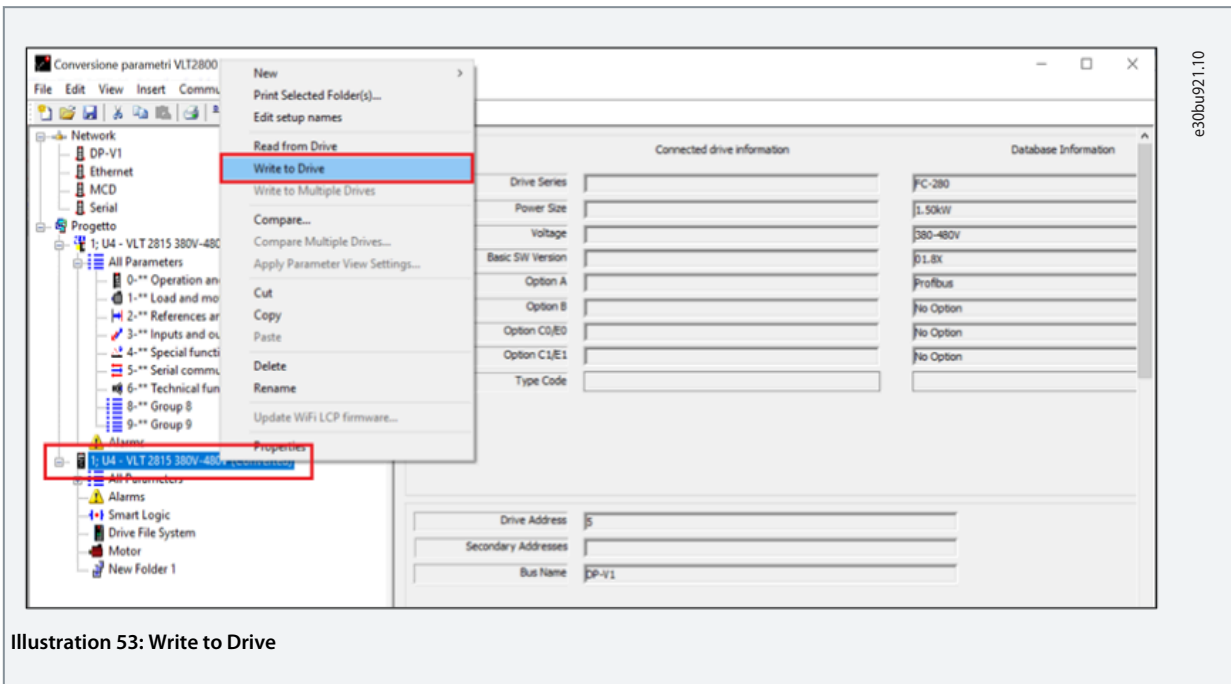

Illustration 53: Write to Drive

22. Once the process has been completed, the unit has been properly programmed and is ready to start.

NOTICE

If there is an alarm after conversion on starting the drive, contact Danfoss Service Support.

8.3 Corresponding Parameter Groups

The corresponding parameter groups between the 2 Drive series are shown in [Illustration 54](#). Although the parameter numbers are in different groups, the parameter attributes are same.

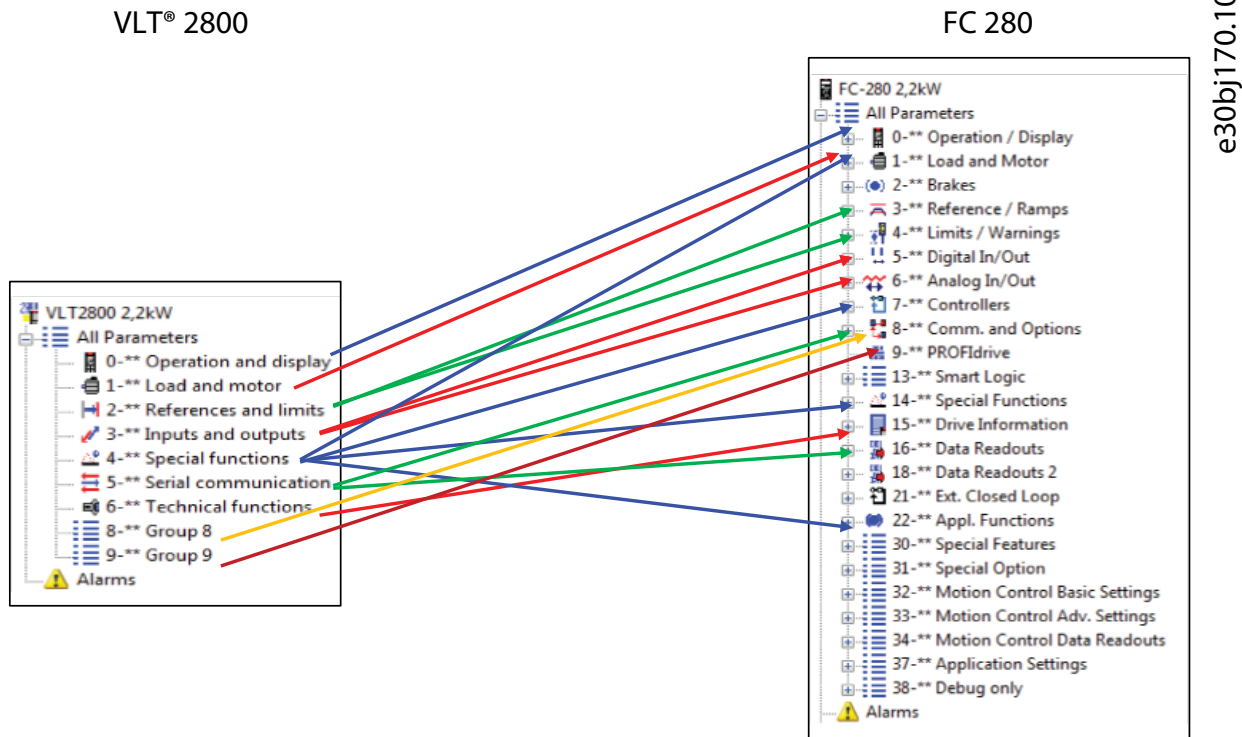

e30bj170.10

Illustration 54: Corresponding Parameter Groups Between the 2 Drive Series

For further details on equivalent parameters, contact Danfoss Drives technical support.

9 Integration with the Existing PROFIBUS Communication

9.1 PROFIBUS Fieldbus

PROFIBUS is a fieldbus system, which can be used for linking automation devices such as sensors and actuators with the controls by means of a 2-conductor cable. PROFIBUS DP is a fast communication protocol, made specially for communication between the automation system and various types of equipment. PROFIBUS is a registered trademark.

The FC Profile protocol available as communication interface in both VLT® 2800 and FC 280 products is not compatible with each other. The products must be reprogrammed and adapted to the new protocol or PROFIdrive profile.

It is necessary to include the MCM 103 memory module. The master detects the new FC 280 automatically as if it was a VLT® 2800, without changing the GSD file.

- The VLT® Memory Module MCM 103 must be ordered as a separate component and is not included in an FC 280 delivery.
- The converter only converts the current value. It does not convert the default values and parameter attributes. The parameters in the list are not set to the VLT 2800 default value automatically, when the drive is initialized.
- For other settings such as node address/baud rate, see [1.3 Additional Resources](#) VLT® Midi Drive FC 280 PROFIBUS DP Programming Guide for more information.
- The FC 280 converter is based on VLT 2800 standard software version 3.23.
- The VLT® Midi Drive FC 280 firmware must be version 1.50 or higher, for the memory module functions to work.
- There is no need to change PLC or upload GSD files.

NOTICE

The PROFIBUS connector on the VLT® Midi Drive FC280 is located on the top of the drive, while the PROFIBUS connection on the VLT®2800 is located on terminals 68/69 at the bottom of the drive.

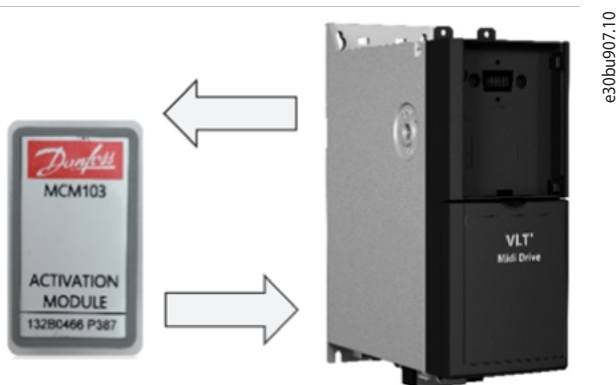

Illustration 55: FC 280 and MCM 103 Memory Module

Insert the MCM 103 Memory Module into its slot. VLT® Memory Module MCM 103 Installation Instructions, see [1.3 Additional Resources](#).

9.2 Integration with Existing PROFIBUS Fieldbus

NOTICE

The parameters of the PROFIBUS interface and communication are not automatically converted by the MCT 10 software setup tool.

- Therefore, the node number, the command reference source, and the emulation enablement of the VLT® 2800 on the fieldbus must be set manually and verified.

For some specific usages of the VLT® 2800 through a fieldbus option, it may be necessary to consider employment of a 24 V backup option (132B0368) when configuring the new drive, since the boot time between the 2 drive series is different.

A list of parameters to set and verify are described in [Table 24](#):

Table 24: Settings for PROFIBUS Communication to Emulate the VLT® 2800

Parameter number	Parameter name	Description	Notes
8-02	Control source	Option A.	–
8-03	Control timeout	Enter time in seconds.	If no time is entered, the parameter is not activated.
8-04	Function after activation of control timeout.	Enter the action to be taken under such condition.	–
8-50.0	Control function	Control function via digital and/or bus.	When selecting the OR logic, a jumper is required between terminals 12 and 27.
9-15.0	Write configuration PCD	Command word fieldbus CTW1.	Required to define the control word.
9-15.1	Write configuration PCD	Fieldbus reference 1.	Required to define the bus reference.
9-15.2 to 9-15.9	Write configuration PCD	Free selection according to the information required in each register.	–
9-16.0	Read configuration PCD	Common option STW.	For reading the status word.
9-16.1	Read configuration PCD	Actual value [%].	For reading the output frequency.
9-16.2 to 9-16.9	Read configuration PCD	Free selection according to the required information in each register.	–
9-18	Node address	PROFIBUS address of the inverter	–
14-70	Compatibility	VLT® 2800 12 M including MAV.	Select the type of PROFIBUS.

The parameters that are supported are specified below:

Possible selections of the parameters to be written via PROFIBUS FC 280 with VLT® 2800 emulation function activated.

These parameters below are write access parameters. In converter mode, these parameters can be selected in *parameter 9-15 PCD write configuration*. In *parameter 9-15 PCD write configuration*, the option number of the converted parameter is the VLT® 2800 parameter number plus 5000. For example, in *parameter 9-15 PCD write configuration*, VLT® 2800 parameter 2-06 Ramp type is shown as [5206] Ramp type.

Table 25: Access to Write Parameters

Name description	Parameter	
	VLT® 2800	FC 280
Ramp type	206	340
Ramp-up time 1	207	341
Ramp-down time 1	208	342
Ramp-up time 2	209	351
Ramp-down time 2	210	352
Jog ramp time	211	380
Qstop ramp time	212	381
Jog frequency	213	311

Name description	Parameter	
	VLT® 2800	FC 280
Preset ref. 1	215	310
Preset ref. 2	216	310.1
Preset ref. 3	217	310.2
Preset ref. 4	218	310.3
Maximum output frequency	202	419
Current limit	221	418

List of possible write parameters:

- [5201] Min output freq
- [5202] Max output freq
- [5204] Min reference
- [5205] Max reference
- [5206] Ramp type
- [5207] Ramp-up time 1
- [5208] Ramp-down time 1
- [5209] Ramp-up time 2
- [5210] Ramp-down time 2
- [5211] Jog ramp time
- [5212] Qstop ramp time
- [5213] Jog frequency
- [5215] Preset ref. 1
- [5216] Preset ref. 2
- [5217] Preset ref. 3
- [5218] Preset ref. 4
- [5219] Catch up/slow down value
- [5221] Current limit

Possible selections of read parameters via PROFIBUS FC 280 with VLT® 2800 emulation function activated.

The parameters below are read access parameters. In converter mode, these parameters can be selected in *parameter 9-16 PCD read configuration*. In *parameter 9-16 PCD read configuration*, the option number of the converted parameter is the VLT® 2800 parameter number plus with 5000. For example, in *parameter 9-16 PCD read configuration*, VLT® 2800 *parameter 5-22 Power [kW]* is shown as *[5522] Power [kW]*.

Table 26: Access to Read Parameters

Name description	Parameter	
	VLT® 2800	FC 280
Power [kW]	522	1610
Power [CV]	523	1611
Motor voltage	524	1612
Frequency	518	1613
Motor current	520	1614

Name description	Parameter	
	VLT® 2800	FC 280
Thermal load motor	526	1618
Torque [%]	521	1622
DC-link voltage	525	1630
Inverter temp.	537	1634
Inverter thermal	527	1635
External reference	533	1650
Feedback (unit)	517	1652
Digital input	528	1660
Term. 53, analog input	529	1662
Term. 60, analog input	531	1664
Pulse count	544	1667
Alarm word	538	1690
Warning word	540	1692
Extended status word	541	1694
Operating hours	600	1500
Running hours	601	1501
kWh counter	602	1502
Power up's	603	1503
Over temp.	604	1504
Over voltage	605	1505

List of possible read parameters:

- [5517] Feedback [Unit]
- [5518] Frequency
- [5520] Motor current
- [5521] Torque [%]
- [5522] Power [kW]
- [5523] Power [hp]
- [5524] Motor voltage
- [5525] DC-link voltage
- [5526] Thermal load motor
- [5527] Inverter thermal
- [5528] Digital input
- [5529] Term. 53, analog input
- [5531] Term. 60, analog input
- [5533] External ref.

Design Guide

- [5537] Inverter temperature
- [5538] Alarm word
- [5540] Warning word
- [5541] Extended status word
- [5544] Pulse count
- [5600] Operating hours
- [5601] Running hours
- [5602] Kwh counter
- [5603] Power up's
- [5604] Over temp's
- [5605] Over volt's

NOTICE

If there is an alarm after conversion on starting the drive, such as fieldbus timeout, overcurrent, contact Danfoss service support.

9.3 Software and Firmware to Support Existing Functionality

After successful configuration of VLT® Midi Drive FC 280, there are zip files for the software and firmware downloads under *Software tab* as shown in the following illustration in the Danfoss Product Store. Log-in to the Product Store is not necessary to download the files. The Software tab is the same for all FC 280 drive power sizes in all countries.

The screenshot shows the Danfoss product page for VLT® 134U2986. The 'Software' section is active, displaying a table of software and firmware files. The table has columns for Software Type, Title, Version, Released, and a download icon (ZIP).

Software Type	Title	Version	Released	
Fieldbus Configuration Files	VLT® Drives PROFIBUS GSD		03/11/2010	ZIP
Fieldbus Configuration Files	VLT® Drives PROFIBUS PCA Block		19/03/2008	ZIP
Fieldbus Configuration Files	VLT® EtherNet/IP Add-on Instructions		27/09/2013	ZIP
Fieldbus Configuration Files	VLT® MCA101 PROFIBUS GSD		03/11/2010	ZIP
Fieldbus Configuration Files	VLT® MCA104 CANopen EDS		23/06/2014	ZIP
Fieldbus Configuration Files	VLT® MCA120 PROFINET GSDML		21/02/2018	ZIP
Fieldbus Configuration Files	VLT® MCA123 POWERLINK XDD		02/08/2013	ZIP
Fieldbus Configuration Files	VLT® Midi Drive FC 280 POWERLINK XDD		09/12/2016	ZIP
Fieldbus Configuration Files	VLT® Midi Drive FC 280 PROFINET GSDML		30/10/2020	ZIP
Fieldbus Configuration Files	VLT® Midi Drive FC 280 PROFIBUS GSD	1.0	10/10/2016	ZIP
Fieldbus Configuration Files	VLT® Midi Drive FC 280 CANopen EDS	1.20	09/12/2016	ZIP
Fieldbus Configuration Files	VLT® Midi Drive FC 280 Ethernet/IP EDS	1.20	09/12/2016	ZIP
Software Tools	VLT® Motion Control Tool MCT31	2.0.4	17/10/2017	ZIP

e30b1666.10

Illustration 56: Software and Firmware to Support Existing Functionality

10 Relevant Technical Characteristics

10.1 Functions Comparison Between the 2 Drives

Following are the main characteristics of VLT® Midi Drive FC 280 to show its versatility and total readiness to be used as a replacement for VLT® 2800:

Table 27: Main Data of VLT® Midi Drive FC 280 and VLT® 2800

Main data	VLT® Midi Drive FC 280	VLT® 2800
Motor control core	VVC ⁺ /UF	VVC ⁺ /UF
Torque characteristic	CT/VT/AEO	CT/VT
Motor data adjustment	AMA	AMT
Motor construction	IM/SPM/IPM	IM
Brake chopper	Yes (3-phase)	Yes
Control card/control unit variants	Standard (Modbus) PROFIBUS DP-V1 PROFINET EtherNet/IP™ CANopen POWERLINK	Standard PROFIBUS DP-V1 DeviceNet
Support of B options	No	No
Support of 24 V power supply	Yes (as option/MCB 106)	No
LCP	NLCP/GLCP/Blind cover	NLCP (built in)
Functional safety (STO/SIL2)	Yes	No
Fan control	Variable speed control	On/Off control
Maximum ambient temperature	45°C (113°F)	45°C (113°F)
EMC maximum cable length IP20	A1 40 m (131 ft)/B 15 m (49 ft) in K1–K2 S2 A1 25 m (82 ft) in K1–K3 T4 A1 50 m (164 ft) in K4–K5 T4 A2 25 m (82 ft) in K1–K5 T4/T2 Unshielded: 75 m (246 ft)	A1 40 m (131 ft)/B 15 m (49 ft) in S2 drive A1 25 m (82 ft) in T4 drive up to 7.5 kW/10 hp A1 20 m (66 ft) in T2 drive
Maximum input voltage	280/480 V AC	240/480 V AC

Table 28: Maximum Cable Length According to EMC Level, Voltage, and Size

VLT® Midi drive FC 280				VLT® 2800		
EMC	V	Enclosure size	Length	EMC	V	Length
A1	S2	K1–K2	40 m (131 ft)	A1	S2	40 m (131 ft)
	T4	K1–K3	25 m (82 ft)		T4 (<7.5 kW/10 hp)	25 m (82 ft)
		K4–K5	50 m (164 ft)			

VLT® Midi drive FC 280				VLT® 2800		
EMC	V	Enclosure size	Length	EMC	V	Length
A2	T4/T2	K1–K5	25 m (82 ft)		T2	20 m (66 ft)
B	S2	K1–K2	15 m (49 ft)			
Without	T4/T2	K1–K5	75 m (246 ft)			

Table 29: Product Features Comparison between VLT® Midi Drive FC 280 and VLT® 2800

Comparison chart	VLT® Midi Drive FC 280	VLT® 2800
Feature/function		
Operating		
Power range 230 V AC 1 Ph (kW)	0.37–2.2	0.37–3.7
Power range 200–240 V AC (kW)	0.37–3.7	0.37–3.7
Power range 380–480 V AC (kW)	0.37–22	0.37–18.5
Ambient temperature °C (°F) (average for 24 hours without derating)	45 (55 maximum with derating) (113 (131 maximum with derating))	40 (104)
Variable switching frequency (kHz)	2–16	3–14
Cable length		
Shielded/Unshielded maximum [m (ft)]	75 (246)	45/75 (148/246)
Control modes		
Motor control	VCC+/U/F	VCC/U/F
Motor types	IM/SPM/IPM	IM
Torque characteristics	CT/VT/AEO	CT/VT
Motor data adjustment	AMA	AMT
Flying start		
Controlled ramps		
Linear & S ramps		
Process PID control		
Precise start/stop		
Reverse signal on keypad		
Digital potentiometer		
4 parameter setups		
Event history logging		
Enclosure styles		
Protected chassis (IP20)		

Comparison chart	VLT® Midi Drive FC 280	VLT® 2800
Feature/function		
NEMA 1 (IP21)	(Only in kit)	(Only in kit)
Special functions		
Smart logic controller SLC		X
Macro mode/Smart start wizards		
Safe Torque Off functionality (ISO 13849-1 PL d)		X
Safe Torque Off over fieldbus (PROFIsafe)		X
User interface		
Numeric keypad	LCP 21 optional	
Graphical keypad	LCP 102 optional	X
Std input/output		
Analog inputs	2	1
Analog outputs	1	1
Digital inputs	6	5
Digital outputs	1	1
Relay outputs	1	1
Communications		
RS485 (built in)		
Protocol (built in)	Modbus RTU, FC protocol	Modbus RTU, FC protocol
USB port (built in)		X
PROFIBUS DP		
DeviceNet	X	
CANopen		X
PROFINET		X
EtherCAT		X
POWERLINK		X
Other functions		
Brake chopper	Yes (3-phase)	
Supports of motor power size	6 (1 size up, 4 size down)	2 (1 size up, 1 size down)
Pluggable control terminals		

Comparison chart	VLT® Midi Drive FC 280	VLT® 2800
Feature/function		
Pluggable mains/motor terminals up to 7.5 kW (10 hp)		
Removable fan		X
Support of 24 V external power supply		X

11 Commissioning Assistance and Installation Checklist

11.1 Commissioning Assistance



Illustration 57: DrivePro® Start-up

DrivePro® Start-up is 1 of a portfolio of service products that Danfoss offers. The service products include direct, professional support from Danfoss personnel during commissioning of the new units to take full advantage of the new features and increased potential that the VLT® Midi Drive FC 280 drive offers.

The Danfoss commissioning service supports customer's by fine-tuning their Danfoss AC drives for optimal performance, right from day 1. It takes the complexity out of commissioning AC drives.

DrivePro® Start-up includes comprehensive inspection of customer's AC drive installation, and a full range of health checks and adjustments to aid smooth and straight-forward commissioning.

The DrivePro® Start-up service is provided to suit the customers time schedule and ensure that the AC drives are installed and configured correctly.



Illustration 58: The DrivePro® Start-up Service

DrivePro® Start-up eliminates unforeseen problems and issues during the start-up process and ensures that the AC drives are fine-tuned for optimal performance. Because of its fixed pricing and easy-to-quote setup, Danfoss sales teams can easily add DrivePro® Start-up to all AC drive projects and applications.

For more information, contact a Danfoss service partner or visit DrivePro® services online:

<https://www.danfoss.com/en/products/dds/drivepro-life-cycle-services/#tab-drivepro-life-cycle-services>

11.2 Installation Checklist

Before completing installation of the unit, inspect the entire installation as detailed in [Table 30](#). Check and mark the items when completed. Before commissioning or start-up, refer to the operating guide and Safety chapter.

⚠ CAUTION ⚠

POTENTIAL HAZARD IN THE EVENT OF INTERNAL FAILURE.

Risk of personal injury if the drive is not properly closed.

- Before applying power ensure that all safety covers are in place and securely fastened.

Table 30: Start-up Checklist

Inspect for	Description	☑
Auxiliary equipment	<ul style="list-style-type: none"> • Look for auxiliary equipment, switches, disconnects, or input fuses/circuit breakers located on input power side of the drive, or output side to the motor. Examine their operational readiness and ensure that they are ready in all respects for operation at full speed. • Check function and installation of any sensors used for feedback to the drive. • Remove power factor correction caps on motor(s), if present. 	
Cable routing	<ul style="list-style-type: none"> • Adjust any power factor correction capacitors on the mains side and ensure that they are dampened. • Ensure that input power, motor wiring, and control wiring are separated or in 3 separate metallic conduits for high-frequency noise isolation. 	
Control wiring	<ul style="list-style-type: none"> • Check for broken or damaged wires and loose connections. • Check that the control wiring is isolated from power and motor wiring for noise immunity. • Check the voltage source of the signals, if necessary. • The use of shielded cable or twisted pair is recommended. Ensure that the shield is terminated correctly at both ends. 	
Cooling clearance	<ul style="list-style-type: none"> • Units require top and bottom clearance adequate to ensure proper airflow for cooling. 	
Ambient conditions	<ul style="list-style-type: none"> • Check that requirements for ambient conditions are met. 	
Fusing and circuit breakers	<ul style="list-style-type: none"> • Check for proper fusing or circuit breakers. • Check that all fuses are inserted firmly and are in operational condition, and that all circuit breakers are in the open position. 	
Grounding	<ul style="list-style-type: none"> • Check for sufficient ground connections and ensure that they are tight and free of oxidation. • Do not ground to conduit or mount the back panel to a metal surface. 	
Input and output power wiring	<ul style="list-style-type: none"> • Check for loose connections • Check that the motor and mains cables are in separate conduit or separated shielded cables 	
Switches	<ul style="list-style-type: none"> • Ensure that all switch and disconnect settings are in the proper position. 	

Inspect for	Description	☑
Panel interior	<ul style="list-style-type: none"> • Inspect that the unit interior is free of dirt, metal chips, moisture, and corrosion. • Check that the unit is mounted on an unpainted, metal surface. 	
Switches	<ul style="list-style-type: none"> • Ensure that all switch and disconnect settings are in the proper positions. 	
Vibration	<ul style="list-style-type: none"> • Check that the unit is mounted solidly or that shock mounts are used, as necessary. • Check for an unusual amount of vibration. 	

12 Retrofitting Non-Danfoss Drives

12.1 Configuration Assistance and Ordering

To retrofit or replace any non-Danfoss drive, fill in, and send the retrofit template at the end of this chapter to Danfoss service center for assistance to configure a new Danfoss drive that best fits the application.

-Or-

Contact a Danfoss service provider to request a DrivePro® Retrofit On-site Audit to document the technical characteristics and application of the drive installation to ensure the correct choice and program application of the new drive. The audit also includes an inspection of the installation site to better plan and speed up the retrofitting service to mitigate down-time and plant productivity.

DrivePro® Retrofit Audit - order code: 130R1329.

DrivePro® Retrofit at a glance

Perform on-site audit*	Danfoss Drives performs an on-site audit to assess the drive system and the application.	<div data-bbox="1070 712 1318 965"> <p>Early Planning saves time and money in retrofitting drives</p> </div> <div data-bbox="1070 1010 1286 1137"> <p>Stay calm. You're covered Danfoss Drives secures:</p> </div> <div data-bbox="1070 1160 1353 1211"> Higher performance </div>
Recommend drives	Danfoss Drives recommends the optimal replacement drive bringing immediate performance improvements to a plant or process.	
Planned delivery scheduling	Tailored scheduling for retrofit drive replacement that fits your budget and timeline, while also ensuring maximum uptime and productivity.	
Installation and commissioning*	Danfoss is ready to support you every step of the way. DrivePro® Start-up is a professional commissioning service that configures the drive according to the process application to ensure the drive is working at its full potential to ensure maximum availability and process performance.	

*Optional service

e30bj208:10

Illustration 59: DrivePro® Retrofit Audit Process

To help replacing non-Danfoss drives:

- Print the following 3 sheets.
- Complete as much as possible.
- Send the 3 sheets to a Danfoss partner.

<h1>DrivePro® Retrofit Checklist</h1>						Page 1/2	
Complete one checklist per drive. Submit checklists with onsite information for each site or building.							
Customer name /building name							
This form completed by name of person?					Date		
Service provider? Company name?							
Existing drive information							
Brand			Model				
Serial number			Reference number				
Input voltage		Hp/kW		Output amps			
Enclosure rating			Other				
Drive condition or other information or notes.							
Motor 1 information							
Brand		Model					
Voltage	Hp/kW	Amps		RPM	Type		
Efficiency @ 50 Hz	Power factor			Motor lead length			
Efficiency @ 60 Hz							
Motor 2 information							
Brand		Model					
Voltage	Hp/kW	Amps		RPM	Type		
Efficiency @ 50 Hz	Power factor			Motor lead length			
Efficiency @ 60 Hz							
Application information							
Fan?	Pump?	Other					
Indoors?	Outdoors?	Environment issues: extreme ambient, moisture, temperature, containments, corrosives, etc.					
Existing drive protection:	YES	NO	Fuse or circuit breaker amp rating and type.				
Power quality issues: voltage? phase balance? capacitance switching?							

<h1>DrivePro® Retrofit Checklist</h1>		Page 2/2	
Complete one checklist per drive. Submit checklists with onsite information for each site or building.			
Conduit entry	Top		Mounting: Solid surface
	Bottom		
Other:		Other:	
Note if single drive or with integrated bypass that requires a back panel if not mounted against solid surface.			
Drive accessories and options/check all that apply or note other.			
Drive disconnect switch		2 contactor bypass	
Main disconnect & bypass switch		3 contactor bypass	
Drive and bypass circuit breaker		Auto bypass	
Separate drive and bypass disconnect		Electro-mechanical bypass	
Single motor		Soft starter bypass	
Dual motor		Notes:	
Contactor motor selection			
Input line reactor: 1.50 %		3 %	5 %
Input EMI filter define:		Output LC filter define:	
Harmonic filter define:			
Common start/stop relay:		Under voltage protection define:	
Any other options: transducer, warning alarms, reversing switch, auxiliary power, etc.			
Input/output & application			
Speed reference:	4-20 mA	0-10 V DC	
Other define:			
Serial communication protocol define:			

NON-Danfoss Drive Retrofit I/O Table

*Complete the table of the existing connections as a reference.
Contact Danfoss for technical assistance as needed.*

Wire colour	Wire number	Existing drive terminal number	Function	Signal type	Voltage	Danfoss drive terminal number.
			<i>Start, stop, safety interlock, speed reference, status, output reference, and so on.</i>	<i>Analog, digital, voltage, current, dry contact, and so on.</i>		Notes to be completed by Danfoss support.

Index

A

Accessories.....	12
Adapter plates.....	23
Additional resources.....	5
AMA.....	40
AMA with T27 connected.....	40
Application and parameter settings.....	39

B

Backward compatibility.....	26
Basic wiring schematic.....	36
Blind cover plate.....	12
Brake cable.....	31
Branch circuit protection.....	45

C

Cable size.....	32
Cables, distance between.....	31
Conduit.....	70
Configuration assistance.....	73
Control cable.....	31
Control wiring.....	70
Cooling clearance.....	70

D

Discharge time.....	8
Document and software version.....	5

E

EMC.....	70
EMC-compliant installation.....	31
Emulation function.....	25
Equalizing cable.....	31

F

Feedback.....	70
Firmware.....	64
Fuses.....	45, 70, 70

G

Graphical display.....	24
Grounding.....	70

H

High-lighted characteristics.....	66
-----------------------------------	----

I

Important user information.....	5
Input power.....	70
Installation.....	70

K

Key features.....	10
Knockout.....	32

L

Larger frame sizes.....	38
Leakage current.....	8
Legacy product.....	9
Life cycle management model.....	9
Local control panel.....	24

M

Main data	
Motor control core.....	66
Brake chopper.....	66
Fan control.....	66
Maximum ambient temperature.....	66
Mains cable.....	31
Management software.....	48
Manual configuration template.....	13
Mechanical installation.....	29
Memory module MCM 103.....	25
Motion control tool 10.....	48
Motor cable.....	31
Motor wiring.....	70

N

Noise isolation.....	70
Numerical display.....	12

P

Patent liability.....	5
PELV.....	44
Power factor.....	70
Power terminal.....	38
Process PID control.....	39
Product features comparison.....	66
PROFIBUS fieldbus.....	60, 60
PROFIBUS network.....	25
PROFINET.....	68

Q

Qualified personnel.....	7
--------------------------	---

R

Range of accessories.....	26
---------------------------	----

S

Safe Torque Off.....	45
Shielded cable.....	32, 70
Software.....	64
Speed reference.....	40
STO.....	45
Symbols.....	7

T

Template.....	73
Terminal function description.....	36
Thermistor.....	44
Type code.....	13

V		W	
VLT® control panel LCP 21 numeric.....	24	Wiring terminal connections.....	38
Voltage		Work-sheet template.....	73
Safety warning.....	7		

Danfoss A/S
Ulsnaes 1
DK-6300 Graasten
vlt-drives.danfoss.com

Danfoss can accept no responsibility for possible errors in catalogs, brochures, and other printed material. Danfoss reserves the right to alter its products without notice. This also applies to products already on order provided that such alterations can be made without subsequential changes being necessary in specifications already agreed. All trademarks in this material are property of the respective companies. Danfoss and the Danfoss logotype are trademarks of Danfoss A/S. All rights reserved.

