



Quick Guide VLT[®] Micro Drive



Contents

1 Quick Guide	2
1.1 Safety	2
1.1.1 Safety Instructions	2
1.2 Introduction	3
1.2.1 Available Literature	3
1.2.2 Approvals	3
1.2.3 IT Mains	3
1.2.4 Avoid Unintended Start	3
1.3 Installation	3
1.3.1 Side-by-Side Installation	3
1.3.2 Mechanical Dimensions	4
1.3.3 Connecting to Mains and Motor	6
1.3.4 Control Terminals	6
1.3.5 Power Circuit - Overview	7
1.3.6 Load Sharing/Brake	8
1.4 Programming	8
1.4.1 Programming with LCP	8
1.4.2 Programming on Automatic Motor Tuning (AMT)	9
1.5 Parameter Overview	10
1.6 Troubleshooting	14
1.6.1 Warnings and Alarms	14
1.7 Specifications	15
1.8 General Technical Data	17
1.9 Special Conditions	19
1.9.1 Derating for Ambient Temperature	19
1.9.2 Derating for Low Air Pressure	19
1.9.3 Derating for Running at Low Speeds	19
1.10 Options for VLT® Micro Drive	20
Index	21

1 Quick Guide

1.1 Safety

⚠ WARNING

HIGH VOLTAGE

Frequency converters contain high voltage when connected to AC mains input power. Installation, start up, and maintenance should be performed by qualified personnel only. Failure to perform installation, start up, and maintenance by qualified personnel could result in death or serious injury.

⚠ WARNING

UNINTENDED START

When the frequency converter is connected to AC mains, the motor may start at any time. The frequency converter, motor, and any driven equipment must be in operational readiness. Failure to be in operational readiness when the frequency converter is connected to AC mains could result in death, serious injury, equipment, or property damage.

⚠ WARNING

DISCHARGE TIME

Frequency converters contain DC-link capacitors that can remain charged even when the frequency converter is not powered. To avoid electrical hazards, disconnect AC mains, any permanent magnet type motors, and any remote DC-link power supplies, including battery backups, UPS and DC-link connections to other frequency converters. Wait for the capacitors to fully discharge before performing any service or repair work. The amount of wait time is listed in the *Discharge Time* table. Failure to wait the specified time after power has been removed before doing service or repair could result in death or serious injury.

Size	Minimum waiting time [min]
M1, M2 and M3	4
M4 and M5	15

Table 1.1 Discharge Time

Leakage Current (>3.5 mA)

Follow national and local codes regarding protective earthing of equipment with a leakage current > 3,5 mA. frequency converter technology implies high frequency switching at high power. This will generate a leakage current in the earth connection. A fault current in the frequency converter at the output power terminals might contain a DC component which can charge the filter capacitors and cause a transient earth current. The earth

leakage current depends on various system configurations including RFI filtering, screened motor cables, and frequency converter power.

EN/IEC61800-5-1 (Power Drive System Product Standard) requires special care if the leakage current exceeds 3,5 mA. Earth grounding must be reinforced in one of the following ways:

- Earth ground wire of at least 10 mm².
- Two separate earth ground wires both complying with the dimensioning rules.

See EN 60364-5-54 § 543.7 for further information.

Using RCDs

Where residual current devices (RCDs), also known as earth leakage circuit breakers (ELCBs), are used, comply with the following:

Use RCDs of type B only which are capable of detecting AC and DC currents.

Use RCDs with an inrush delay to prevent faults due to transient earth currents.

Dimension RCDs according to the system configuration and environmental considerations.

Motor Thermal Protection

Motor overload protection is possible by setting Parameter 1-90 Motor thermal protection to the value ETR trip. For the North American market: Implemented ETR function provide class 20 motor overload protection, in accordance with NEC.

Installation at High Altitudes

For altitudes above 2 km, contact Danfoss regarding PELV.

1.1.1 Safety Instructions

- Make sure the frequency converter is properly connected to earth.
- Do not remove mains connections, motor connections or other power connections while the frequency converter is connected to power.
- Protect users against supply voltage.
- Protect the motor against overloading according to national and local regulations.
- The earth leakage current exceeds 3.5 mA.
- The [Off/Reset] key is not a safety switch. It does not disconnect the frequency converter from mains.

1.2 Introduction

1.2.1 Available Literature

NOTICE

This quick guide contains the basic information necessary for installing and running the frequency converter.

If more information is needed, the literature below can be downloaded from:

<http://www.danfoss.com/BusinessAreas/DrivesSolutions/Documentations>

Title	Literature no.
VLT Micro Drive FC 51 Design Guide	MG02K
VLT Micro Drive FC 51 Quick Guide	MG02B
VLT Micro Drive FC 51 Programming Guide	MG02C
FC 51 LCP Mounting Instruction	MI02A
FC 51 De-coupling Plate Mounting Instruction	MI02B
FC 51 Remote Mounting Kit Mounting Instruction	MI02C
FC 51 DIN Rail Kit Mounting Instruction	MI02D
FC 51 IP21 Kit Mounting Instruction	MI02E
FC 51 Nema1 Kit Mounting Instruction	MI02F
Line Filter MCC 107 Installation Instruction	MI02U

Table 1.2

1.2.2 Approvals

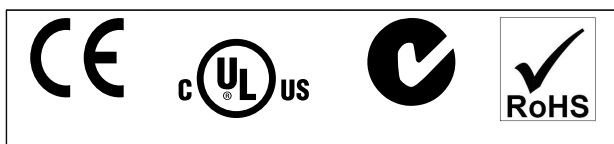

Table 1.3

1.2.3 IT Mains

NOTICE

IT Mains
Installation on isolated mains source, i.e. IT mains.

Max. supply voltage allowed when connected to mains: 440 V.

As an option, Danfoss offers recommended line filters for improved harmonics performance.

1.2.4 Avoid Unintended Start

While the frequency converter is connected to mains, the motor can be started/stopped using digital commands, bus commands, references or via the LCP or LOP.

- Disconnect the frequency converter from mains whenever personal safety considerations make it necessary to avoid unintended start of any motors.
- To avoid unintended start, always press [Off/Reset] before changing parameters.



Equipment containing electrical components must not be disposed of together with domestic waste. It must be separately collected with electrical and electronic waste according to local and currently valid legislation.

1.3 Installation

1. Disconnect FC 51 from mains (and external DC supply, if present.)
2. Wait for 4 min (M1, M2 and M3) and 15 min (M4 and M5) for discharge of the DC-link. See *Table 1.1*.
3. Disconnect DC bus terminals and brake terminals (if present).
4. Remove motor cable.

1.3.1 Side-by-Side Installation

The frequency converter can be mounted side-by-side for IP20 rating units and requires 100 mm clearance above and below for cooling. Refer to the specifications near the end of this document for details on environmental ratings of the frequency converter.

1.3.2 Mechanical Dimensions

A template for drilling can be found on the flap of the packaging.

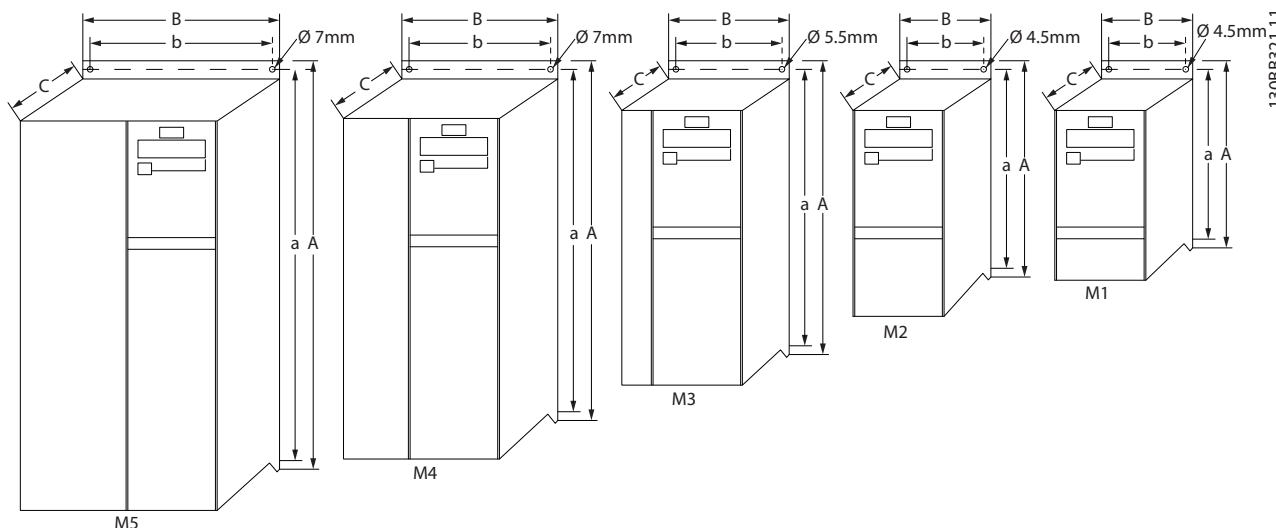

Illustration 1.1 Mechanical Dimensions

Enclosure	Power [kW]			Height [mm]			Width [mm]		Depth ¹⁾ [mm]	Max. Weight
	1X200-240 V	3X200-240 V	3X380-480 V	A	A (incl. decoupling plate)	a	B	b	C	Kg
M1	0.18-0.75	0.25-0.75	0.37-0.75	150	205	140.4	70	55	148	1.1
M2	1.5	1.5	1.5-2.2	176	230	166.4	75	59	168	1.6
M3	2.2	2.2-3.7	3.0-7.5	239	294	226	90	69	194	3.0
M4			11.0-15.0	292	347.5	272.4	125	97	241	6.0
M5			18.5-22.0	335	387.5	315	165	140	248	9.5

¹⁾ ForLCP with potentiometer, add 7.6 mm.

Table 1.4 Mechanical Dimensions

NOTICE

All cabling must comply with national and local regulations on cable cross-sections and ambient temperature. Copper conductors required, (60-75 °C) recommended.

Enclosure	Power [kW]			Torque [Nm]					
	1x200-240 V	3x200-240 V	3x380-480 V	Line	Motor	DC connection/Brake	Control Terminals	Earth	Relay
M1	0.18-0.75	0.25-0.75	0.37-0.75	1.4	0.7	Spade ¹⁾	0.15	3	0.5
M2	1.5	1.5	1.5-2.2	1.4	0.7	Spade ¹⁾	0.15	3	0.5
M3	2.2	2.2-3.7	3.0-7.5	1.4	0.7	Spade ¹⁾	0.15	3	0.5
M4			11.0-15.0	1.3	1.3	1.3	0.15	3	0.5
M5			18.5-22.0	1.3	1.3	1.3	0.15	3	0.5

¹⁾ Spade connectors (6.3 mm Faston plugs)

Table 1.5 Tightening of Terminals

Branch circuit protection

To protect the installation against electrical and fire hazard, all branch circuits in an installation, switch gear, machines etc., must be short-circuited and overcurrent protected according to national/international regulations.

Provide overload protection to avoid overheating of the cables in the installation. Overcurrent protection must always be carried out according to national regulations. Fuses must be designed for protection in a circuit capable of supplying a maximum of 100,000 A_{rms} (symmetrical), 480 V maximum.

Short circuit protection

Danfoss recommends using the fuses mentioned in the following tables to protect service personnel or other equipment in case of an internal failure in the unit or short-circuit on DC-link. The frequency converter provides full short circuit protection in case of a short-circuit on the motor or brake output.

Non UL compliance

If UL/cUL is not to be complied with, Danfoss recommends using the fuses mentioned in *Table 1.7*, which ensures compliance with EN50178/IEC61800-5-1:

In case of malfunction, not following the fuse recommendation may result in damage to the frequency converter and the installation.

Overcurrent protection

FC 51	Max. Fuses UL						Max. fuses non UL
	Bussmann	Bussmann	Bussmann	Littel fuse	Ferraz-Shawmut	Ferraz-Shawmut	
1X200-240 V							
kW	Type RK1	Type J	Type T	Type RK1	Type CC	Type RK1	Type gG
0K18-0K37	KTN-R15	JKS-15	JJN-15	KLN-R15	ATM-R15	A2K-15R	16A
0K75	KTN-R25	JKS-25	JJN-25	KLN-R25	ATM-R25	A2K-25R	25A
1K5	KTN-R35	JKS-35	JJN-35	KLN-R35	-	A2K-35R	35A
2K2	KTN-R50	JKS-50	JJN-50	KLN-R50	-	A2K-50R	50A
3x200-240 V							
0K25	KTN-R10	JKS-10	JJN-10	KLN-R10	ATM-R10	A2K-10R	10A
0K37	KTN-R15	JKS-15	JJN-15	KLN-R15	ATM-R15	A2K-15R	16A
0K75	KTN-R20	JKS-20	JJN-20	KLN-R20	ATM-R20	A2K-20R	20A
1K5	KTN-R25	JKS-25	JJN-25	KLN-R25	ATM-R25	A2K-25R	25A
2K2	KTN-R40	JKS-40	JJN-40	KLN-R40	ATM-R40	A2K-40R	40A
3K7	KTN-R40	JKS-40	JJN-40	KLN-R40	-	A2K-40R	40A
3x380-480 V							
0K37-0K75	KTS-R10	JKS-10	JJS-10	KLS-R10	ATM-R10	A6K-10R	10A
1K5	KTS-R15	JKS-15	JJS-15	KLS-R15	ATM-R15	A2K-15R	16A
2K2	KTS-R20	JKS-20	JJS-20	KLS-R20	ATM-R20	A6K-20R	20A
3K0	KTS-R40	JKS-40	JJS-40	KLS-R40	ATM-R40	A6K405R	40A
4K0	KTS-R40	JKS-40	JJS-40	KLS-R40	ATM-R40	A6K-40R	40A
5K5	KTS-R40	JKS-40	JJS-40	KLS-R40	-	A6K-40R	40A
7K5	KTS-R40	JKS-40	JJS-40	KLS-R40	-	A6K-40R	40A
11K0	KTS-R60	JKS-60	JJS-60	KLS-R60	-	A6K-60R	63A
15K0	KTS-R60	JKS-60	JJS-60	KLS-R60	-	A6K-60R	63A
18K5	KTS-R60	JKS-60	JJS-60	KLS-R60	-	A6K-60R	80A
22K0	KTS-R60	JKS-60	JJS-60	KLS-R60	-	A6K-60R	80A

Table 1.6 Fuses

1.3.3 Connecting to Mains and Motor

The frequency converter is designed to operate all standard three-phased asynchronous motors. The frequency converter is designed to accept mains/ motor cables with a maximum cross-section of 4 mm²/10 AWG (M1, M2 and M3) and maximum cross-section 16 mm²/6 AWG (M4 and M5).

- Use a shielded/armoured motor cable to comply with EMC emission specifications, and connect this cable to both the decoupling plate and the motor metal.
 - Keep motor cable as short as possible to reduce the noise level and leakage currents.
 - For further details on mounting of the decoupling plate, see *VLT Micro FC 51 Decoupling Mounting Plate Instructions*.
 - Also see EMC-Correct Installation in the *Design Guide*.
1. Mount the earth wires to earth terminal.
 2. Connect motor to terminals U, V and W.
 3. Mount mains supply to terminals L1/L, L2 and L3/N (3-phase) or L1/L and L3/N (single-phase) and tighten.

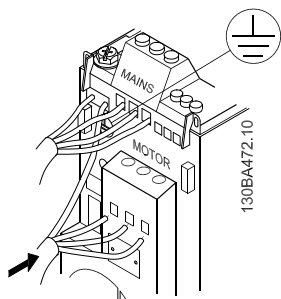

Illustration 1.2 Mounting of Earth Cable, Mains and Motor Wires

1.3.4 Control Terminals

All control cable terminals are located underneath the terminal cover in front of the frequency converter. Remove the terminal cover using a screwdriver.

NOTICE

See back of terminal cover for outlines of control terminals and switches.

NOTICE

Do not operate switches with power on the frequency converter.
6-19 Terminal 53 Mode must be set according to Switch 4 position.

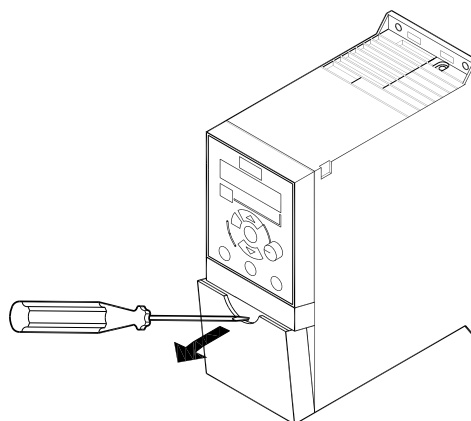

Illustration 1.3 Removing Terminal Cover

Switch 1	*OFF=PNP terminals 29 ON=NPN terminals 29
Switch 2	*OFF=PNP terminal 18, 19, 27 and 33 ON=NPN terminal 18, 19, 27 and 33
Switch 3	No function
Switch 4	*OFF=Terminal 53 0-10 V ON=Terminal 53 0/4-20 mA
*=default setting	

Table 1.7 Settings for S200 Switches 1-4

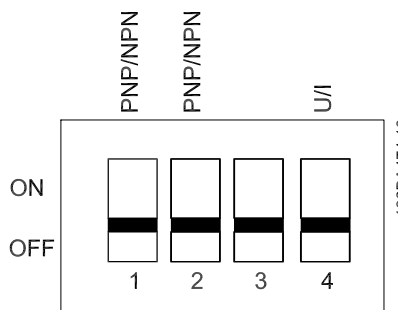

Illustration 1.4 S200 Switches 1-4

Illustration 1.5 shows all control terminals of the frequency converter. Applying Start (term. 18) and an analog reference (term. 53 or 60) make the frequency converter run.

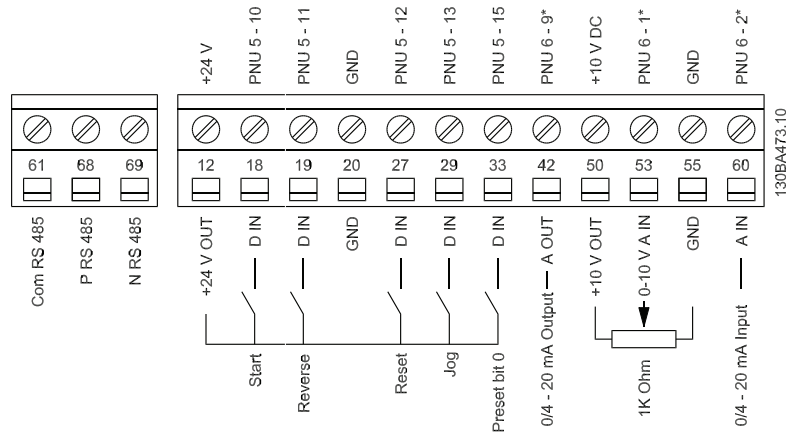

Illustration 1.5 Overview of Control Terminals in PNP-configuration and Factory Setting

1.3.5 Power Circuit - Overview

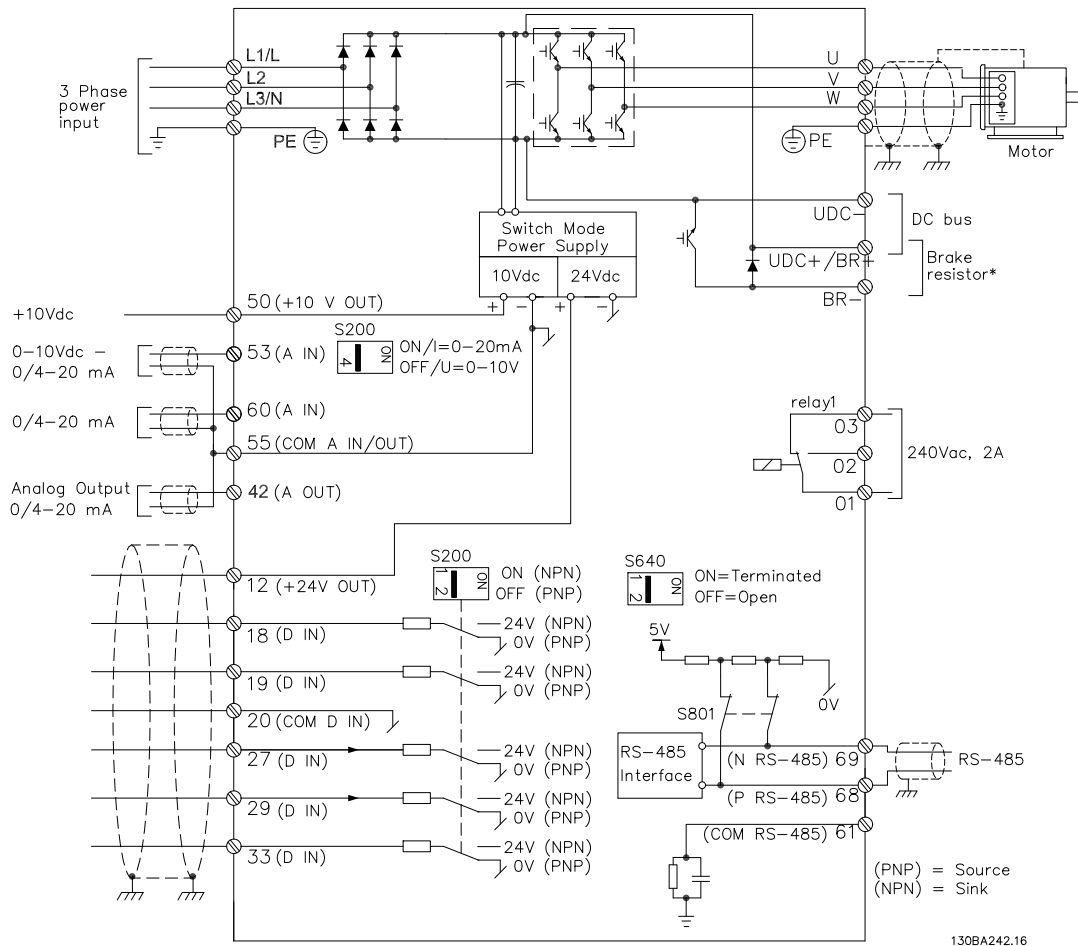

Illustration 1.6 Diagram Showing all Electrical Terminals

* Brake (BR+ and BR-) are not applicable for frame M1.

Brake resistors are available from Danfoss. Improved power factor and EMC performance can be achieved by installing optional Danfoss line filters. Danfoss power filters can also be used for load sharing.

1.3.6 Load Sharing/Brake

Use 6.3 mm insulated Faston Plugs designed for high voltage for DC (Load Sharing and brake). Contact Danfoss or see *instruction MI50N* for load sharing and *instruction MI90F* for brake.

Load sharing: Connect terminals -UDC and +UDC/+BR.
 Brake: Connect terminals -BR and +UDC/+BR (Not applicable for frame M1).

NOTICE

Voltage levels of up to 850 V DC may occur between terminals +UDC/+BR and -UDC. Not short circuit protected.

1.4 Programming

1.4.1 Programming with LCP

For detailed information on programming, see *VLT MICRO DRIVE FC 51 Programming Guide*.

NOTICE

The frequency converter can also be programmed from a PC via RS-485 com-port by installing the MCT 10 Set-up Software.

This software can either be ordered using code number 130B1000 or downloaded from the Danfoss Web site: www.danfoss.com/BusinessAreas/DrivesSolutions/softwaredownload

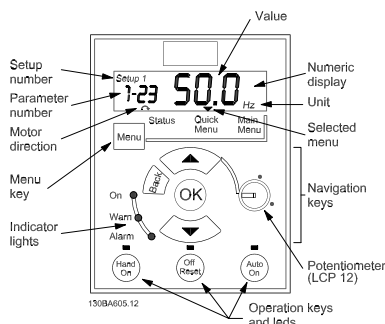

Illustration 1.7 Description of LCP Buttons and Display

Press [Menu] to select one of the following menus:

Status

For readouts only.

Quick Menu

For access to Quick Menus 1 and 2, respectively.

Main Menu

For access to all parameters.

Navigation Keys

[Back]: For moving to the previous step or layer in the navigation structure.

[▲] [▼]: For manoeuvring between parameter groups, parameters and within parameters.

[OK]: For selecting a parameter and for accepting changes to parameter settings.

Pressing [OK] for more than 1 s enters 'Adjust' mode. In 'Adjust' mode, it is possible to make fast adjustment by pressing [▲] [▼] combined with [OK].

Press [▲] [▼] to change value. Press [OK] to shift between digits quickly.

To exit 'Adjust' mode, press [OK] more than 1 s again with changes saving or press [Back] without changes saving.

Operation Keys

A yellow light above the operation keys indicates the active key.

[Hand On]: Starts the motor and enables control of the frequency converter via the LCP.

[Off/Reset]: The motor stops except in alarm mode. In that case the motor will be reset.

[Auto on]: The frequency converter is controlled either via control terminals or serial communication.

[Potentiometer] (LCP12): The potentiometer works in two ways depending on the mode in which the frequency converter is running.

In *Auto Mode* the potentiometer acts as an extra programmable analog input.

In *Hand on Mode* the potentiometer controls local reference.

1.4.2 Programming on Automatic Motor Tuning (AMT)

It is highly recommended to run AMT because it measures the electrical characteristics of the motor to optimize compatibility between the frequency converter and the motor under VVC^{plus} mode.

- The frequency converter builds a mathematical model of the motor for regulating output motor current thus enhancing motor performance.
- Run this procedure on a cold motor for best results To run AMT using the numeric LCP (NLCP) There is two AMT mode for drive. Mode1

1. Enter the main menu.
2. Go to parameter group 1-** *Load and Motor*.
3. Press [OK]
4. Set motor parameters using name plate data for parameter group 1-1-2* *Motor Data*.
5. Go to 1-29 *Automatic Motor Tuning (AMT)*.
6. Press [OK].
7. Select [2] *Enable AMT*

8. Press [OK].
9. The test will run automatically and indicate when it is complete.

Mode2

1. Enter the main menu.
2. Go to parameter group 1-** *Load and Motor*.
3. Press [OK].
4. Set motor parameters using name plate data for parameter group 1-1-2* *Motor Data*.
5. Go to 1-29 *Automatic Motor Tuning (AMT)*.
6. Press [OK]
7. Select [3] *Complete AMT with Rotating motor*
8. Press [OK]
9. The test will run automatically and indicate when it is complete.

NOTICE

Note! In mode 2 the rotor would rotating during the AMT progress. No load should add on motor in this AMT progress.

1.5 Parameter Overview

Parameter Overview			
<p>0-** Operation/Display 0-0* Basic Settings 0-03 Regional Settings *[0] International [1] US 0-04 Oper. State at Power-up (Hand) [0] Resume *[1] Forced stop, ref=old [2] Forced stop, ref=0 0-1* Set-up Handling 0-10 Active Set-up *[1] Setup 1 [2] Setup 2 [9] Multi Setup 0-11 Edit Set-up *[1] Setup 1 [2] Setup 2 [9] Active Setup 0-12 Link Setups [0] Not Linked *[20] Linked 0-31 Custom Readout Min Scale 0.00 – 9999.00 * 0.00 0-32 Custom Readout Max Scale 0.00 – 9999.00 * 100.0 0-4* Keypad 0-40 [Hand on] Key on [0] Disabled *[1] Enabled 0-41 [Off / Reset] Key on [0] Disable All *[1] Enable All [2] Enable Reset Only 0-42 [Auto on] Key on [0] Disabled *[1] Enabled 0-5* Copy/Save 0-50 Copy *[0] No copy [1] All to [2] All from [3] Size indep. from 0-51 Set-up Copy *[0] No copy [1] Copy from setup 1 [2] Copy from setup 2 [9] Copy from Factory setup 0-6* Password 0-60 (Main) Menu Password 0-999 *0 0-61 Access to Main/Quick Menu w/o Password *[0] Full access [1] LCP:Read Only [2] LCP:No Access 1-** Load/Motor 1-0* General Settings 1-00 Configuration Mode *[0] Speed open loop [3] Process 1-01 Motor Control Principle [0] U/f *[1] VVC+ 1-03 Torque Characteristics *[0] Constant torque [2] Automatic Energy Optim.</p>	<p>1-05 Local Mode Configuration [0] Speed Open Loop *[2] As config in par. 1-00 1-2* Motor Data 1-20 Motor Power [kW] [HP] [1] 0.09 kW/0.12 HP [2] 0.12 kW/0.16 HP [3] 0.18 kW/0.25 HP [4] 0.25 kW/0.33 HP [5] 0.37 kW/0.50 HP [6] 0.55 kW/0.75 HP [7] 0.75 kW/1.00 HP [8] 1.10 kW/1.50 HP [9] 1.50 kW/2.00 HP [10] 2.20 kW/3.00 HP [11] 3.00 kW/4.00 HP [12] 3.70 kW/5.00 HP [13] 4.00 kW/5.40 HP [14] 5.50 kW/7.50 HP [15] 7.50 kW/10.00 HP [16] 11.00 kW/15.00 HP [17] 15.00 kW/20.00 HP [18] 18.50 kW/25.00 HP [19] 22.00 kW/29.50 HP [20] 30.00 kW/40.00 HP 1-22 Motor Voltage 50-999 V *230 -400 V 1-23 Motor Frequency 20-400 Hz *50 Hz 1-24 Motor Current 0.01-100.00 A *Motortype dep. 1-25 Motor Nominal Speed 100-9999 rpm *Motortype dep. 1-29 Automatic Motor Tuning (AMT) *[0] Off [2] Enable AMT [3] Complete AMT with Rotating motor 1-3* Adv. Motor Data 1-30 Stator Resistance (Rs) [Ohm] * Dep. on motor data 1-33 Stator Leakage Reactance (X1) [Ohm] * Dep. on motor data 1-35 Main Reactance (Xh) [Ohm] * Dep. on motor data 1-5* Load Indep. Setting 1-50 Motor Magnetisation at 0 Speed 0-300% *100% 1-52 Min Speed Norm. Magnet. [Hz] 0.0-10.0 Hz *0.0Hz 1-55 U/f Characteristic - U 0-999.9 V 1-56 U/f Characteristic - F 0-400 Hz 1-6* Load Depen. Setting 1-60 Low Speed Load Compensation 0-199% *100% 1-61 High Speed Load Compensation 0-199% *100% 1-62 Slip Compensation -400-399% *100%</p>	<p>1-63 Slip Compensation Time Constant 0.05-5.00 s *0.10 s 1-7* Start Adjustments 1-71 Start Delay 0.0-10.0 s *0.0 s 1-72 Start Function [0] DC hold/delay time [1] DC brake/delay time *[2] Coast/delay time 1-73 Flying Start *[0] Disabled [1] Enabled 1-8* Stop Adjustments 1-80 Function at Stop *[0] Coast [1] DC hold 1-82 Min Speed for Funct. at Stop [Hz] 0.0-20.0 Hz *0.0 Hz 1-9*Motor Temperature 1-90 Motor Thermal Protection *[0] No protection [1] Thermistor warning [2] Thermistor trip [3] Etr warning [4] Etr trip 1-93 Thermistor Resource *[0] None [1] Analog input 53 [6] Digital input 29 2-** Brakes 2-0*DC-Brake 2-00 DC Hold Current 0-150% *50% 2-01 DC Brake Current 0-150% *50% 2-02 DC Braking Time 0.0-60.0 s *10.0s 2-04 DC Brake Cut In Speed 0.0-400.0 Hz *0.0Hz 2-1* Brake Energy Funct. 2-10 Brake Function *[0] Off [1] Resistor brake [2] AC brake 2-11 Brake Resistor (ohm) 5 -5000 *5 2-14 Brake Voltage reduce 0 - Powersize dep.* 0 2-16 AC Brake, Max current 0-150% *100% 2-17 Over-voltage Control *[0] Disabled [1] Enabled (not at stop) [2] Enabled 2-2* Mechanical Brake 2-20 Release Brake Current 0.00-100.0 A *0.00 A 2-22 Activate Brake Speed [Hz] 0.0-400.0 Hz *0.0 Hz 3-** Reference / Ramps 3-0* Reference Limits 3-00 Reference Range *[0] Min - Max [1] -Max - +Max</p>	<p>3-02 Minimum Reference -4999-4999 *0.000 3-03 Maximum Reference -4999-4999 *50.00 3-1* References 3-10 Preset Reference -100.0-100.0% *0.00% 3-11 Jog Speed [Hz] 0.0-400.0 Hz *5.0 Hz 3-12 Catch up/slow Down Value 0.00 - 100.0% * 0.00% 3-14 Preset Relative Reference -100.0-100.0% *0.00% 3-15 Reference Resource 1 [0] No function *[1] Analog Input 53 [2] Analog input 60 [8] Pulse input 33 [11] Local bus ref [21] Potentiometer 3-16 Reference Resource 2 [0] No function [1] Analog in 53 *[2] Analog in 60 [8] Pulse input 33 [11] Local bus reference [21] Lcp Potentiometer 3-17 Reference Resource 3 [0] No function [1] Analog Input 53 [2] Analog input 60 [8] Pulse input 33 *[11] Local bus ref [21] Potentiometer 3-18 Relative Scaling Ref. Resource *[0] No function [1] Analog Input 53 [2] Analog input 60 [8] Pulse input 33 *[11] Local bus ref [21] Potentiometer 3-4* Ramp 1 3-40 Ramp 1 Type *[0] Linear [2] Sine2 ramp 3-41 Ramp 1 Ramp up Time 0.05-3600 s *3.00 s (10.00 s¹) 3-42 Ramp 1 Ramp Down Time 0.05-3600 s *3.00s (10.00s¹) 3-5* Ramp 2 3-50 Ramp 2 Type *[0] Linear [2] Sine2 ramp 3-51 Ramp 2 Ramp up Time 0.05-3600 s *3.00 s (10.00 s¹) 3-52 Ramp 2 Ramp down Time 0.05-3600 s *3.00 s (10.00 s¹) 3-8* Other Ramps 3-80 Jog Ramp Time 0.05-3600 s *3.00 s (10.00s¹) 3-81 Quick Stop Ramp Time 0.05-3600 s *3.00 s (10.00s¹)</p>

¹⁾ M4 and M5 only

Table 1.8

<p>4-** Limits/Warnings 4-1* Motor Limits 4-10 Motor Speed Direction *[0] Clockwise If Par. 1-00 is set to close loop control [1] CounterClockwise *[2] Both if Par. 1-00 is set to open loop control 4-12 Motor Speed Low Limit [Hz] 0.0-400.0 Hz *0.0 Hz 4-14 Motor Speed High Limit [Hz] 0.1-400.0 Hz *65.0 Hz 4-16 Torque Limit Motor Mode 0-400% *150% 4-17 Torque Limit Generator Mode 0-400% *100% 4-4* Adj. Warnings 2 4-40 Warning Frequency Low 0.00 - Value of 4-41 Hz *0.0 Hz 4-41 Warning Frequency High Value of 4-40-400.0 Hz *400.00 Hz 4-5* Adj. Warnings 4-50 Warning Current Low 0.00-100.00 A *0.00 A 4-51 Warning Current High 0.0-100.00 A *100.00 A 4-54 Warning Reference Low -4999.000 - Value of 4-55 * -4999.000 4-55 Warning Reference High Value of 4-54 -4999.000 *4999.000 4-56 Warning Feedback Low -4999.000 - Value of 4-57 * -4999.000 4-57 Warning Feedback High Value of 4-56-4999.000 *4999.000 4-58 Missing Motor Phase Function [0] Off *[1] On 4-6* Speed Bypass 4-61 Bypass Speed From [Hz] 0.0-400.0 Hz *0.0 Hz 4-63 Bypass Speed To [Hz] 0.0 -400.0 Hz *0.0 Hz 5-1* Digital Inputs 5-10 Terminal 18 Digital Input [0] No function [1] Reset [2] Coast inverse [3] Coast and reset inv. [4] Quick stop inverse [5] DC-brake inv. [6] Stop inv *[8] Start [9] Latched start [10] Reversing [11] Start reversing [12] Enable start forward [13] Enable start reverse [14] Jog [16-18] Preset ref bit 0-2 [19] Freeze reference</p>	<p>5-10 Terminal 18 Digital Input [20] Freeze output [21] Speed up [22] Speed down [23] Setup select bit 0 [28] Catch up [29] Slow down [34] Ramp bit 0 [60] Counter A (up) [61] Counter A (down) [62] Reset counter A [63] Counter B (up) [64] Counter B (down) [65] ResetCounter B 5-11 Terminal 19 Digital Input See par. 5-10. * [10] Reversing 5-12 Terminal 27 Digital Input See par. 5-10. * [1] Reset 5-13 Terminal 29 Digital Input See par. 5-10. * [14] Jog 5-15 Terminal 33 Digital Input See par. 5-10. * [16] Preset ref bit 0 [26] Precise Stop Inverse [27] Start, Precise Stop [32] Pulse Input 5-3* Digital Outputs 5-34 On Delay, Terminal 42 Digital Output 0.00 - 600.00 s * 0.01 s 5-35 Off Delay, Terminal 42 Digital Output 0.00 - 600.00 s * 0.01 s 5-4* Relays 5-40 Function Relay *[0] No operation [1] Control ready [2] Drive ready [3] Drive ready, Remote [4] Enable / No warning [5] Drive running [6] Running / No warning [7] Run in range / No warning [8] Run on ref / No warning [9] Alarm [10] Alarm or warning [12] Out of current range [13] Below current, low [14] Above current, high [16] Below frequency, low [17] Above frequency, high [19] Below feedback, low [20] Above feedback, high [21] Thermal warning [22] Ready, No thermal warning [23] Remote ready, No thermal warning [24] Ready, Voltage ok [25] Reverse [26] Bus ok [28] Brake,NoWarn [29] Brake ready/NoFault [30] BrakeFault (IGBT) [32] Mech.brake control [36] Control word bit 11 [41] Below reference, low [42] Above reference, high [51] Local ref. active</p>	<p>5-40 Function Relay [52] Remote ref. active [53] No alarm [54] Start cmd active [55] Running reverse [56] Drive in hand mode [57] Drive in auto mode [60-63] Comparator 0-3 [70-73] Logic rule 0-3 [81] SL digital output B 5-41 On Delay, Relay 0.00-600.00 s *0.01 s 5-42 Off Delay, Relay 0.00-600.00 s *0.01 s 5-5* Pulse Input 5-55 Terminal 33 Low Frequency 20-4999 Hz *20 Hz 5-56 Terminal 33 High Frequency 21-5000 Hz *5000 Hz 5-57 Term. 33 Low Ref./Feedb. Value -4999-4999 *0.000 5-58 Term. 33 High Ref./Feedb. Value -4999-4999 *50.000 6-** Analog In/Out 6-0* Analog I/O Mode 6-00 Live Zero Timeout Time 1-99 s *10 s 6-01 Live Zero TimeoutFunction *[0] Off [1] Freeze output [2] Stop [3] Jogging [4] Max speed [5] Stop and trip 6-1* Analog Input 1 6-10 Terminal 53 Low Voltage 0.00-9.99 V *0.07 V 6-11 Terminal 53 High Voltage 0.01-10.00 V *10.00 V 6-12 Terminal 53 Low Current 0.00-19.99 mA *0.14 mA 6-13 Terminal 53 High Current 0.01-20.00 mA *20.00 mA 6-14 Term. 53 Low Ref./Feedb. Value -4999-4999 *0.000 6-15 Term. 53 High Ref./Feedb. Value -4999-4999 *50.000 6-16 Terminal 53 Filter Time Constant 0.01-10.00 s *0.01 s 6-19 Terminal 53 mode *[0] Voltage mode [1] Current mode</p>	<p>6-2* Analog Input 2 6-22 Terminal 60 Low Current 0.00-19.99 mA *0.14 mA 6-23 Terminal 60 High Current 0.01-20.00 mA *20.00 mA 6-24 Term. 60 Low Ref./Feedb. Value -4999-4999 *0.000 6-25 Term. 60 High Ref./Feedb. Value -4999-4999 *50.00 6-26 Terminal 60 Filter Time Constant 0.01-10.00 s *0.01 s 6-8* potentiometer 6-80 LCP Potmeter Enable [0] Disabled *[1] Enable 6-81 potm. Low Reference -4999-4999 *0.000 6-82 potm. High Reference -4999-4999 *50.00 6-9* Analog Output xx 6-90 Terminal 42 Mode *[0] 0-20 mA [1] 4-20 mA [2] Digital Output 6-91 Terminal 42 Analog Output *[0] No operation [10] Output Frequency [11] Reference [12] Feedback [13] Motor Current [16] Power [19] DC Link Voltage [20] Bus Reference 6-92 Terminal 42 Digital Output See par. 5-40 *[0] No Operation [80] SL Digital Output A 6-93 Terminal 42 Output Min Scale 0.00-200.0% *0.00% 6-94 Terminal 42 Output Max Scale 0.00-200.0% *100.0% 7-** Controllers 7-2* Process Ctrl. Feedb 7-20 Process CL Feedback 1 Resource *[0] NoFunction [1] Analog Input 53 [2] Analog input 60 [8] PulselInput33 [11] LocalBusRef</p>
---	--	--	--

Table 1.9

<p>7-3* Process PI Ctrl. 7-30 Process PI Normal/ Inverse Ctrl *[0] Normal [1] Inverse 7-31 Process PI Anti Windup [0] Disable *[1] Enable 7-32 Process PI Start Speed 0.0-200.0 Hz *0.0 Hz 7-33 Process PI Proportional Gain 0.00-10.00 *0.01 7-34 Process PI Integral Time 0.10-9999 s *9999 s 7-38 Process PI Feed Forward Factor 0-400% *0% 7-39 On Reference Bandwidth 0-200% *5% 8-** Comm. and Options 8-0* General Settings 8-01 Control Site *[0] Digital and ControlWord [1] Digital only [2] ControlWord only 8-02 Control Word Source [0] None *[1] FC RS485 8-03 Control Word Timeout Time 0.1-6500 s *1.0 s 8-04 Control Word Timeout Function *[0] Off [1] Freeze Output [2] Stop [3] Jogging [4] Max. Speed [5] Stop and trip 8-06 Reset Control Word Timeout *[0] No Function [1] Do reset 8-3* FC Port Settings 8-30 Protocol *[0] FC [2] Modbus 8-31 Address 1-247 *1 8-32 FC Port Baud Rate [0] 2400 Baud [1] 4800 Baud *[2] 9600 Baud For choose FC Bus in 8-30 *[3] 19200 Baud For choose Modbus in 8-30 [4] 38400 Baud 8-33 FC Port Parity *[0] Even Parity, 1 Stop Bit [1] Odd Parity, 1 Stop Bit [2] No Parity, 1 Stop Bit [3] No Parity, 2 Stop Bits 8-35 Minimum Response Delay 0.001-0.5 *0.010 s 8-36 Max Response Delay 0.100-10.00 s *5.000 s</p>	<p>8-4* FC MC protocol set 8-43 FC Port PCD Read Configuration *[0] None Expressionlimit [1] [1500] Operation Hours [2] [1501] Running Hours [3] [1502] kWh Counter [4] [1600] Control Word [5] [1601] Reference [Unit] [6] [1602] Reference % [7] [1603] Status Word [8] [1605] Main Actual Value [%] [9] [1609] Custom Readout [10] [1610] Power [kW] [11] [1611] Power [hp] [12] [1612] Motor Voltage [13] [1613] Frequency [14] [1614] Motor Current [15] [1615] Frequency [%] [16] [1618] Motor Thermal [17] [1630] DC Link Voltage [18] [1634] Heatsink Temp. [19] [1635] Inverter Thermal [20] [1638] SL Controller State [21] [1650] External Reference [22] [1651] Pulse Reference [23] [1652] Feedback [Unit] [24] [1660] Digital Input 18,19,27,33 [25] [1661] Digital Input 29 [26] [1662] Analog Input 33 (V) [27] [1663] Analog Input 53 (mA) [28] [1664] Analog Input 60 [29] [1665] Analog Output 42 [mA] [30] [1668] Freq. Input 33 [Hz] [31] [1671] Relay Output [bin] [32] [1672] Counter A [33] [1673] Counter B [34] [1690] Alarm Word [35] [1692] Warning Word [36] [1694] Ext. Status Word 8-5* Digital/Bus 8-50 Coasting Select [0] DigitalInput [1] Bus [2] LogicAnd *[3] LogicOr 8-51 Quick Stop Select See par. 8-50 * [3] LogicOr 8-52 DC Brake Select See par. 8-50 *[3] LogicOr 8-53 Start Select See par. 8-50 *[3] LogicOr 8-54 Reversing Select See par. 8-50 *[3] LogicOr 8-55 Set-up Select See par. 8-50 *[3] LogicOr 8-56 Preset Reference Select See par. 8-50 * [3] LogicOr 8-8* Bus communication Diagnostics 8-80 Bus Message Count 0-0 N/A *0 N/A 8-81 Bus Error Count 0-0 N/A *0 N/A 8-82 Slave Messages Rcvd 0-0 N/A *0 N/A 8-83 Slave Error Count 0-0 N/A *0 N/A</p>	<p>8-9* Bus Jog / Feedback 8-94 Bus feedback 1 0x8000-0x7FFF *0 13-** Smart Logic 13-0* SLC Settings 13-00 SL Controller Mode *[0] Off [1] On 13-01 Start Event [0] False [1] True [2] Running [3] InRange [4] OnReference [7] OutOfCurrentRange [8] BelowLow [9] AboveHigh [16] ThermalWarning [17] MainOutOfRange [18] Reversing [19] Warning [20] Alarm_Trip [21] Alarm_TripLock [22-25] Comparator 0-3 [26-29] LogicRule0-3 [33] DigitalInput_18 [34] DigitalInput_19 [35] DigitalInput_27 [36] DigitalInput_29 [38] DigitalInput_33 *[39] StartCommand [40] DriveStopped 13-02 Stop Event See par. 13-01 * [40] DriveStopped 13-03 Reset SLC *[0] Do not reset [1] Reset SLC 13-1* Comparators 13-10 Comparator Operand *[0] Disabled [1] Reference [2] Feedback [3] MotorSpeed [4] MotorCurrent [6] MotorPower [7] MotorVoltage [8] DCLinkVoltage [12] AnalogInput53 [13] AnalogInput60 [18] PulseInput33 [20] AlarmNumber [30] CounterA [31] CounterB 13-11 Comparator Operator [0] Less Than *[1] Approximately equals [2] Greater Than 13-12 Comparator Value -9999-9999 *0.0 13-2* Timers 13-20 SL Controller Timer 0.0-3600 s *0.0 s</p>	<p>13-4* Logic Rules 13-40 Logic Rule Boolean 1 See par. 13-01 *[0] False [30] - [32] SL Time-out 0-2 13-41 Logic Rule Operator 1 *[0] Disabled [1] And [2] Or [3] And not [4] Or not [5] Not and [6] Not or [7] Not and not [8] Not or not 13-42 Logic Rule Boolean 2 See par. 13-40 * [0] False 13-43 Logic Rule Operator 2 See par. 13-41 *[0] Disabled 13-44 Logic Rule Boolean 3 See par. 13-40 * [0] False 13-5* States 13-51 SL Controller Event See par. 13-40 *[0] False 13-52 SL Controller Action *[0] Disabled [1] NoAction [2] SelectSetup1 [3] SelectSetup2 [10-17] SelectPresetRef0-7 [18] SelectRamp1 [19] SelectRamp2 [22] Run [23] RunReverse [24] Stop [25] Qstop [26] DCstop [27] Coast [28] FreezeOutput [29] StartTimer0 [30] StartTimer1 [31] StartTimer2 [32] Set Digital Output A Low [33] Set Digital Output B Low [38] Set Digital Output A High [39] Set Digital Output B High [60] ResetCounterA [61] ResetCounterB 14-** Special Functions 14-0* Inverter Switching 14-01 Switching Frequency [0] 2 kHz *[1] 4 kHz [2] 8 kHz [4] 16 kHz not available for M5 14-03 Overmodulation [0] Off *[1] On 14-1* Mains monitoring 14-12 Function at mains imbalance *[0] Trip [1] Warning [2] Disabled</p>
---	---	--	---

Table 1.10

<p>14-2* Trip Reset 14-20 Reset Mode * [0] Manual reset [1-9] AutoReset 1-9 [10] AutoReset 10 [11] AutoReset 15 [12] AutoReset 20 [13] Infinite auto reset [14] Reset at power up 14-21 Automatic Restart Time 0 - 600s * 10s 14-22 Operation Mode * [0] Normal Operation [2] Initialisation 14-26 Action At Inverter Fault * [0] Trip [1] Warning 14-4* Energy Optimising 14-41 AEO Minimum Magnetisation 40 - 75 % * 66 % 14-9* Fault Settings 14-90 Fault level[3] Trip Lock [4] Trip with delayed reset 15-** Drive Information 15-0* Operating Data 15-00 Operating Days 15-01 Running Hours 15-02 kWh Counter 15-03 Power Ups 15-04 Over Temps</p>	<p>15-05 Over Volts 15-06 Reset kWh Counter * [0] Do not reset [1] Reset counter 15-07 Reset Running Hours Counter * [0] Do not reset [1] Reset counter 15-3* Fault Log 15-30 Fault Log: Error Code 15-4* Drive Identification 15-40 FC Type 15-41 Power Section 15-42 Voltage 15-43 Software Version 15-46 Frequency Converter Order. No 15-48 Id No 15-51 Frequency Converter Serial No 16-** Data Readouts 16-0* General Status 16-00 Control Word 0-0XFFFF 16-01 Reference [Unit] -4999-4999 *0.000 16-02 Reference % -200.0-200.0% *0.0% 16-03 Status Word 0-0XFFFF 16-05 Main Actual Value [%] -200.0-200.0% *0.0% 16-09 Custom Readout Dep. on par. 0-31, 0-32</p>	<p>16-1* Motor Status 16-10 Power [kW] 16-11 Power [hp] 16-12 Motor Voltage [V] 16-13 Frequency [Hz] 16-14 Motor Current [A] 16-15 Frequency [%] 16-18 Motor Thermal [%] 16-3* Drive Status 16-30 DC Link Voltage 16-34 Heatsink Temp. 16-35 Inverter Thermal 16-36 Inv.Nom. Current 16-37 Inv. Max. Current 16-38 SL Controller State 16-5* Ref./Feedb. 16-50 External Reference 16-51 Pulse Reference 16-52 Feedback [Unit] 16-6* Inputs/Outputs 16-60 Digital Input 18,19,27,33 0-1111 16-61 Digital Input 29 0-1 16-62 Analog Input 53 (volt) 16-63 Analog Input 53 (current) 16-64 Analog Input 60 16-65 Analog Output 42 [mA] 16-68 Pulse Input [Hz]</p>	<p>16-71 Relay Output [bin] 16-72 Counter A 16-73 Counter B 16-8* Fieldbus/FC Port 16-86 FC Port REF 1 0x8000-0x7FFFF 16-9* Diagnosis Readouts 16-90 Alarm Word 0-0XFFFFFFFF 16-92 Warning Word 0-0XFFFFFFFF 16-94 Ext. Status Word 0-0XFFFFFFFF 18-** Extended Motor Data 18-8* Motor Resistors 18-80 Stator Resistance (High resolution) 0.000-99.990 ohm *0.000 ohm 18-81 Stator Leakage Reactance(High resolution) 0.000-99.990 ohm *0.000 ohm</p>
---	--	---	---

Table 1.11

1.6 Troubleshooting

1.6.1 Warnings and Alarms

No.	Description	Warning	Alarm	Trip Lock	Error	Cause of Problem
2	Live zero error	X	X			Signal on terminal 53 or 60 is less than 50% of value set in 6-10 Terminal 53 Low Voltage, 6-12 Terminal 53 Low Current and 6-22 Terminal 54 Low Current.
4	Mains phase loss ¹⁾	X	X	X		Missing phase on supply side, or too high voltage imbalance. Check supply voltage.
7	DC over voltage ¹⁾	X	X			Intermediate circuit voltage exceeds limit.
8	DC under voltage ¹⁾	X	X			Intermediate circuit voltage drops below "voltage warning low" limit.
9	Inverter overloaded	X	X			More than 100% load for too long.
10	Motor ETR over temperature	X	X			Motor is too hot due to more than 100% load for too long.
11	Motor thermistor over temperature	X	X			Thermistor or thermistor connection is disconnected.
12	Torque limit	X				Torque exceeds value set in either par. 4-16 or 4-17.
13	Over Current	X	X	X		Inverter peak current limit is exceeded.
14	Earth fault	X	X	X		Discharge from output phases to ground.
16	Short Circuit		X	X		Short-circuit in motor or on motor terminals.
17	Control word timeout	X	X			No communication to frequency converter.
25	Brake resistor short-circuited		X	X		Brake resistor is short-circuited, thus brake function is disconnected.
27	Brake chopper short-circuited		X	X		Brake transistor is short-circuited, thus brake function is disconnected.
28	Brake check		X			Brake resistor is not connected/working
29	Power board over temp	X	X	X		Heat-sink cut-out temperature has been reached.
30	Motor phase U missing		X	X		Motor phase U is missing. Check the phase.
31	Motor phase V missing		X	X		Motor phase V is missing. Check the phase.
32	Motor phase W missing		X	X		Motor phase W is missing. Check the phase.
38	Internal fault		X	X		Contact local Danfoss supplier.
44	Earth fault		X	X		Discharge from output phases to ground.
47	Control Voltage Fault		X	X		24 V DC may be overloaded.
51	AMA check U _{nom} and I _{nom}		X			Wrong setting for motor voltage and/or motor current.
52	AMA low I _{nom}		X			Motor current is too low. Check settings.
59	Current limit	X				VLT overload.
63	Mechanical Brake Low		X			Actual motor current has not exceeded "release brake" current within "start delay" time window.
80	Drive Initialised to Default Value		X			All parameter settings are initialized to default settings.
84	The connection between drive and LCP is lost				X	No communication between LCP and frequency converter
85	Button disabled				X	See parameter group 0-4* LCP
86	Copy fail				X	An error occurred while copying from frequency converter to LCP or vice versa.
87	LCP data invalid				X	Occurs when copying from LCP if the LCP contains erroneous data - or if no data was uploaded to the LCP.
88	LCP data not compatible				X	Occurs when copying from LCP if data are moved between frequency converters with major differences in software versions.
89	Parameter read only				X	Occurs when trying to write to a read-only parameter.
90	Parameter database busy				X	LCP and RS485 connection are trying to update parameters simultaneously.
91	Parameter value is not valid in this mode				X	Occurs when trying to write an illegal value to a parameter.
92	Parameter value exceeds the min/max limits				X	Occurs when trying to set a value outside the range.
nw run	Not While RUNNING				X	Parameter can only be changed when the motor is stopped.
Err.	A wrong password was entered				X	Occurs when using a wrong password for changing a password-protected parameter.

¹⁾ These faults may be caused by mains distortions. Installing Danfoss Line Filter may rectify this problem.

Table 1.12 Warnings and Alarms Code List

1.7 Specifications

1.7.1 Mains Supply 1x200-240 V AC

Normal overload 150% for 1 minute							
Frequency converter		PK18	PK37	PK75	P1K5	P2K2	
Typical Shaft Output [kW]		0.18	0.37	0.75	1.5	2.2	
Typical Shaft Output [HP]		0.25	0.5	1	2	3	
IP 20		M1	M1	M1	M2	M3	
Output current							
	Continuous (1x200-240 V AC) [A]	1.2	2.2	4.2	6.8	9.6	
	Intermittent (1x200-240 V AC) [A]	1.8	3.3	6.3	10.2	14.4	
	Max. cable size:						
	(mains, motor) [mm ² /AWG]	4/10					
Max. input current							
	Continuous (1x200-240 V) [A]	3.3	6.1	11.6	18.7	26.4	
	Intermittent (1x200-240 V) [A]	4.5	8.3	15.6	26.4	37.0	
	Max. mains fuses [A]	See 1.3.3 Fuses					
	Environment						
	Estimated power loss [W], Best case/Typical ¹⁾	12.5/ 15.5	20.0/ 25.0	36.5/ 44.0	61.0/ 67.0	81.0/ 85.1	
	Weight enclosure IP20 [kg]	1.1	1.1	1.1	1.6	3.0	
Efficiency [%], Best case/Typical ¹⁾	95.6/ 94.5	96.5/ 95.6	96.6/ 96.0	97.0/ 96.7	96.9/ 97.1		

Table 1.13 Mains Supply 1x200-240 V AC

1. At rated load conditions.

1.7.2 Mains Supply 3x200-240 V AC

Normal overload 150% for 1 min								
Frequency converter		PK25	PK37	PK75	P1K5	P2K2	P3K7	
Typical Shaft Output [kW]		0.25	0.37	0.75	1.5	2.2	3.7	
Typical Shaft Output [HP]		0.33	0.5	1	2	3	5	
IP 20		M1	M1	M1	M2	M3	M3	
Output current								
	Continuous (3x200-240 V) [A]	1.5	2.2	4.2	6.8	9.6	15.2	
	Intermittent (3x200-240 V) [A]	2.3	3.3	6.3	10.2	14.4	22.8	
	Max. cable size:							
	(mains, motor) [mm ² /AWG]	4/10						
Max. input current								
	Continuous (3x200-240 V) [A]	2.4	3.5	6.7	10.9	15.4	24.3	
	Intermittent (3x200-240 V) [A]	3.2	4.6	8.3	14.4	23.4	35.3	
	Max.mains fuses [A]	See 1.3.3 Fuses						
	Environment							
	Estimated power loss [W], Best case/Typical ¹⁾	14.0/ 20.0	19.0/ 24.0	31.5/ 39.5	51.0/ 57.0	72.0/ 77.1	115.0/ 122.8	
	Weight enclosure IP20 [kg]	1.1	1.1	1.1	1.6	3.0	3.0	
Efficiency [%], Best case/Typical ¹⁾	96.4/ 94.9	96.7/ 95.8	97.1/ 96.3	97.4/ 97.2	97.2/ 97.4	97.3/ 97.4		

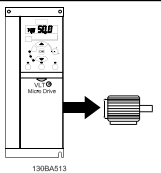
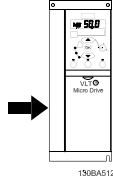
Table 1.14 Mains Supply 3x200-240 V AC

¹⁾ At rated load conditions.

1.7.3 Mains Supply 3x380-480 V AC

Normal overload 150% for 1 minute								
Frequency converter		PK37	PK75	P1K5	P2K2	P3K0	P4K0	
Typical Shaft Output [kW]		0.37	0.75	1.5	2.2	3.0	4.0	
Typical Shaft Output [HP]		0.5	1	2	3	4	5	
IP 20		M1	M1	M2	M2	M3	M3	
Output current								
	Continuous (3x380-440 V) [A]	1.2	2.2	3.7	5.3	7.2	9.0	
	Intermittent (3x380-440 V) [A]	1.8	3.3	5.6	8.0	10.8	13.7	
	Continuous (3x440-480 V) [A]	1.1	2.1	3.4	4.8	6.3	8.2	
	Intermittent (3x440-480 V) [A]	1.7	3.2	5.1	7.2	9.5	12.3	
	Max. cable size:							
	(mains, motor) [mm ² /AWG]							4/10
Max. input current								
	Continuous (3x380-440 V) [A]	1.9	3.5	5.9	8.5	11.5	14.4	
	Intermittent (3x380-440 V) [A]	2.6	4.7	8.7	12.6	16.8	20.2	
	Continuous (3x440-480 V) [A]	1.7	3.0	5.1	7.3	9.9	12.4	
	Intermittent (3x440-480 V) [A]	2.3	4.0	7.5	10.8	14.4	17.5	
	Max. mains fuses [A]							See 1.3.3 Fuses
	Environment							
	Estimated power loss [W], Best case/ Typical ¹⁾	18.5/ 25.5	28.5/ 43.5	41.5/ 56.5	57.5/ 81.5	75.0/ 101.6	98.5/ 133.5	
	Weight enclosure IP20 [kg]	1.1	1.1	1.6	1.6	3.0	3.0	
Efficiency [%], Best case/ Typical ¹⁾	96.8/ 95.5	97.4/ 96.0	98.0/ 97.2	97.9/ 97.1	98.0/ 97.2	98.0/ 97.3		

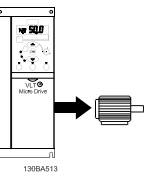
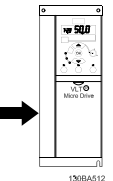
Table 1.15 Mains Supply 3x380-480 V AC

1. At rated load conditions.

Normal overload 150% for 1 minute								
Frequency converter		P5K5	P7K5	P11K	P15K	P18K	P22K	
Typical Shaft Output [kW]		5.5	7.5	11	15	18.5	22	
Typical Shaft Output [HP]		7.5	10	15	20	25	30	
IP 20		M3	M3	M4	M4	M5	M5	
Output current								
	Continuous (3x380-440 V) [A]	12.0	15.5	23.0	31.0	37.0	43.0	
	Intermittent (3x380-440 V) [A]	18.0	23.5	34.5	46.5	55.5	64.5	
	Continuous (3x440-480 V) [A]	11.0	14.0	21.0	27.0	34.0	40.0	
	Intermittent (3x440-480 V) [A]	16.5	21.3	31.5	40.5	51.0	60.0	
	Max. cable size:							
	(mains, motor) [mm ² /AWG]	4/10			16/6			
Max. input current								
	Continuous (3x380-440 V) [A]	19.2	24.8	33.0	42.0	34.7	41.2	
	Intermittent (3x380-440 V) [A]	27.4	36.3	47.5	60.0	49.0	57.6	
	Continuous (3x440-480 V) [A]	16.6	21.4	29.0	36.0	31.5	37.5	
	Intermittent (3x440-480 V) [A]	23.6	30.1	41.0	52.0	44.0	53.0	
	Max. mains fuses [A]							See 1.3.3 Fuses
	Environment							
	Estimated power loss [W], Best case/ Typical ¹⁾	131.0/ 166.8	175.0/ 217.5	290.0/ 342.0	387.0/ 454.0	395.0/ 428.0	467.0/ 520.0	
	Weight enclosure IP20 [kg]	3.0	3.0					
Efficiency [%], Best case/ Typical ¹⁾	98.0/ 97.5	98.0/ 97.5	97.8/ 97.4	97.7/ 97.4	98.1/ 98.0	98.1/ 97.9		

Table 1.16 Mains Supply 3x380-480 V AC

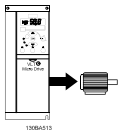
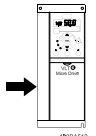
1. At rated load conditions.

1.8 General Technical Data

Protection and features

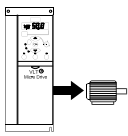
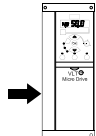
- Electronic thermal motor protection against overload.
- Temperature monitoring of the heat sink ensures that the frequency converter trips in case of overtemperature
- The frequency converter is protected against short-circuits between motor terminals U, V, W.
- When a motor phase is missing, the frequency converter trips and issues an alarm.
- When a mains phase is missing, the frequency converter trips or issues a warning (depending on the load).
- Monitoring of the intermediate circuit voltage ensures that the frequency converter trips, when the intermediate circuit voltage is too low or too high.
- The frequency converter is protected against earth faults on motor terminals U, V, W.

Mains supply (L1/L, L2, L3/N)

Supply voltage	200-240 V ±10%
Supply voltage	380-480 V ±10%
Supply frequency	50/60 Hz
Max. imbalance temporary between mains phases	3.0% of rated supply voltage
True Power Factor	≥0.4 nominal at rated load
Displacement Power Factor (cosφ) near unity	(>0.98)
Switching on input supply L1/L, L2, L3/N (power-ups)	maximum 2 times/min.
Environment according to EN60664-1	overvoltage category III/pollution degree 2

The unit is suitable for use on a circuit capable of delivering not more than 100.000 RMS symmetrical Amperes, 240/480 V maximum.

Motor output (U, V, W)

Output voltage	0-100% of supply voltage
Output frequency	0-200 Hz (VVC ^{plus}), 0-400 Hz (u/f)
Switching on output	Unlimited
Ramp times	0.05-3600 s

Cable lengths and cross sections

Max. motor cable length, screened/armoured (EMC correct installation)	15 m
Max. motor cable length, unscreened/unarmoured	50 m
Max. cross section to motor, mains*	
Connection to load sharing/brake (M1, M2, M3)	6.3 mm insulated Faston Plugs
Max. cross section to load sharing/brake (M4, M5)	16 mm ² /6 AWG
Maximum cross section to control terminals, rigid wire	1.5 mm ² /16 AWG (2x0.75 mm ²)
Maximum cross section to control terminals, flexible cable	1 mm ² /18 AWG
Maximum cross section to control terminals, cable with enclosed core	0.5 mm ² /20 AWG
Minimum cross section to control terminals	0.25 mm ²

* See 1.7 Specifications for more information!

Digital inputs (pulse/encoder inputs)

Programmable digital inputs (pulse/encoder)	5 (1)
Terminal number	18, 19, 27, 29, 33,
Logic	PNP or NPN
Voltage level	0-24 V DC
Voltage level, logic '0' PNP	<5 V DC
Voltage level, logic '1' PNP	>10 V DC
Voltage level, logic '0' NPN	>19 V DC
Voltage level, logic '1' NPN	<14 V DC
Maximum voltage on input	28 V DC
Input resistance, R _i	approx. 4 kΩ
Max. pulse frequency at terminal 33	5000 Hz

Min. pulse frequency at terminal 33	20 Hz
Analog Inputs	
Number of analog inputs	2
Terminal number	53, 60
Voltage mode (Terminal 53)	Switch S200=OFF(U)
Current mode (Terminal 53 and 60)	Switch S200=ON(I)
Voltage level	0-10 V
Input resistance, R_i	approx. 10 k Ω
Max. voltage	20 V
Current level	0/4 to 20 mA (scaleable)
Input resistance, R_i	approx. 200 Ω
Max. current	30 mA
Analog output	
Number of programmable analog outputs	1
Terminal number	42
Current range at analog output	0/4-20 mA
Max. load to common at analog output	500 Ω
Max. voltage at analog output	17 V
Accuracy on analog output	Max. error: 0.8% of full scale
Scan interval	4 ms
Resolution on analog output	8 bit
Scan interval	4 ms
Control card, RS-485 serial communication	
Terminal number	68 (P,TX+, RX+), 69 (N,TX-, RX-)
Terminal number 61	Common for terminals 68 and 69
Control card, 24 V DC output	
Terminal number	12
Max. load (M1 and M2)	100 mA
Max. load (M3)	50 mA
Max. load (M4 and M5)	80 mA
Relay output	
Programmable relay output	1
Relay 01 Terminal number	01-03 (break), 01-02 (make)
Max. terminal load (AC-1) ¹⁾ on 01-02 (NO) (Resistive load)	250 V AC, 2 A
Max. terminal load (AC-15) ¹⁾ on 01-02 (NO) (Inductive load @ $\cos\phi$ 0.4)	250 V AC, 0.2 A
Max. terminal load (DC-1) ¹⁾ on 01-02 (NO) (Resistive load)	30 V DC, 2 A
Max. terminal load (DC-13) ¹⁾ on 01-02 (NO) (Inductive load)	24 V DC, 0.1 A
Max. terminal load (AC-1) ¹⁾ on 01-03 (NC) (Resistive load)	250 V AC, 2 A
Max. terminal load (AC-15) ¹⁾ on 01-03 (NC) (Inductive load @ $\cos\phi$ 0.4)	250 V AC, 0.2 A
Max. terminal load (DC-1) ¹⁾ on 01-03 (NC) (Resistive load)	30 V DC, 2 A
Min. terminal load on 01-03 (NC), 01-02 (NO)	24 V DC 10 mA, 24 V AC 20 mA
Environment according to EN 60664-1	overvoltage category III/pollution degree 2
¹⁾ IEC 60947 part 4 and 5	
Control card, 10 V DC output	
Terminal number	50
Output voltage	10.5 V \pm 0.5 V
Max. load	25 mA

NOTICE

All inputs, outputs, circuits, DC supplies and relay contacts are galvanically isolated from the supply voltage (PELV) and other high-voltage terminals.

Surroundings

Enclosure	IP20
Enclosure kit available	IP21, TYPE 1
Vibration test	1.0 g
Max. relative humidity	5%-95 % (IEC 60721-3-3; Class 3K3 (non-condensing) during operation
Aggressive environment (IEC 60721-3-3), coated	class 3C3
Test method according to IEC 60068-2-43 H2S (10 days)	
Ambient temperature	Max. 40 °C

Derating for high ambient temperature, see

Minimum ambient temperature during full-scale operation	0 °C
Minimum ambient temperature at reduced performance	- 10 °C
Temperature during storage/transport	-25 to +65/70 °C
Maximum altitude above sea level without derating	1000 m
Maximum altitude above sea level with derating	3000 m

Derating for high altitude, see 1.9 Special Conditions

Safety standards	EN/IEC 61800-5-1, UL 508C
EMC standards, Emission	EN 61800-3, EN 61000-6-3/4, EN 55011, IEC 61800-3 EN 61800-3, EN 61000-6-1/2, EN 61000-4-2, EN 61000-4-3, EN 61000-4-4, EN 61000-4-5, EN 61000-4-6
EMC standards, Immunity	

See 1.9 Special Conditions

1.9 Special Conditions

1.9.1 Derating for Ambient Temperature

The ambient temperature measured over 24 hours should be at least 5 °C lower than the max. ambient temperature.

If the frequency converter is operated at high ambient temperature, the continuous output current should be decreased.

The frequency converter has been designed for operation at max 50 °C ambient temperature with one motor size smaller than nominal. Continuous operation at full load at 50 °C ambient temperature will reduce the lifetime of the frequency converter.

1.9.2 Derating for Low Air Pressure

The cooling capability of air is decreased at low air pressure.

For altitudes above 2000 m, contact Danfoss regarding PELV.

Below 1000 m altitude no de-rating is necessary but above 1000 m the ambient temperature or the maximum output current should be decreased.
Decrease the output by 1% per 100 m altitude above 1000 m or reduce the max. ambient temperature by 1 degree per 200 m.

1.9.3 Derating for Running at Low Speeds

When a motor is connected to a frequency converter, it is necessary to check that the cooling of the motor is adequate.

A problem may occur at low speeds in constant torque applications. Running continuously at low speeds – below half the nominal motor speed – may require additional air cooling. Alternatively, choose a larger motor (one size up).

1.10 Options for VLT® Micro Drive

Ordering No	Description
132B0100	VLT Control Panel LCP 11 w/o potentiometer
132B0101	VLT Control Panel LCP 12 with potentiometer
132B0102	Remote Mounting Kit for LCP incl. 3 m cable IP55 with LCP 11, IP21 with LCP 12
132B0103	Nema Type 1 kit for M1 frame
132B0104	Type 1 kit for M2 frame
132B0105	Type 1 kit for M3 frame
132B0106	De-coupling plate kit for M1 and M2 frames
132B0107	De-coupling plate kit for M3 frame
132B0108	IP21 for M1 frame
132B0109	IP21 for M2 frame
132B0110	IP21 for M3 frame
132B0111	DIN rail mounting kit for M1 and M2 frames
132B0120	Type 1 kit for M4 frame
132B0121	Type 1 kit for M5 frame
132B0122	De-coupling plate kit for M4 and M5 frames
132B0126	M1 frame spare parts kits
132B0127	M2 frame spare parts kits
132B0128	M3 frame spare parts kits
132B0129	M4 frame spare parts kits
132B0130	M5 frame spare parts kits
132B0131	Blank cover
130B2522	MCC 107 filter for 132F0001
130B2522	MCC 107 filter for 132F0002
130B2533	MCC 107 filter for 132F0003
130B2525	MCC 107 filter for 132F0005
130B2530	MCC 107 filter for 132F0007
130B2523	MCC 107 filter for 132F0008
130B2523	MCC 107 filter for 132F0009
130B2523	MCC 107 filter for 132F0010
130B2526	MCC 107 filter for 132F0012
130B2531	MCC 107 filter for 132F0014
130B2527	MCC 107 filter for 132F0016
130B2523	MCC 107 filter for 132F0017
130B2523	MCC 107 filter for 132F0018
130B2524	MCC 107 filter for 132F0020
130B2526	MCC 107 filter for 132F0022
130B2529	MCC 107 filter for 132F0024
130B2531	MCC 107 filter for 132F0026
130B2528	MCC 107 filter for 132F0028
130B2527	MCC 107 filter for 132F0030

Table 1.17

Danfoss Line Filters and brake resistors are available upon request.

Index

A

Active Set-up..... 10
 Ambient Temperature..... 19
 Analog Inputs..... 18

B

Brake
 Resistor (ohm)..... 10
 Resistor Short-circuited..... 14

C

Cable Lengths And Cross Sections..... 17
 Clearance..... 3
 Control Card, 24 V DC Output..... 18

D

DC-brake..... 11
 DC-Brake..... 10
 De-coupling Plate Kit..... 20
Derating
 For Ambient Temperature..... 19
 For Low Air Pressure..... 19
 For Running At Low Speeds..... 19

Digital

Inputs..... 17
 Inputs (pulse/encoder Inputs)..... 17
 DIN Rail Mounting Kit..... 20

E

Earth Leakage Current..... 2
 Edit Set-up..... 10
 Electronic Waste..... 3

G

Ground Wire..... 2
 Grounding..... 2

H

Hand Mode..... 11

I

IP21..... 20
 Isolated Mains Source..... 3
 IT Mains..... 3

L

Load
 Compensation..... 10
 Sharing/Brake..... 8

M

Main Menu..... 8

Mains

Supply..... 15
 Supply (L1/L, L2, L3/N)..... 17
 Supply 1x200-240 V AC..... 15
 Supply 3x200-240 V AC..... 15
 Supply 3x380-480 V AC..... 16

Motor

Output (U, V, W)..... 17
 Overload Protection..... 2
 Phase..... 11
 Protection..... 17
 Temperature..... 10

N

Navigation Keys..... 8
 Nema Type 1 Kit..... 20

O

Operation Keys..... 8
 Output Performance (U, V, W)..... 17
 Overcurrent Protection..... 5
 Over-voltage Control..... 10

P

Power Circuit - Overview..... 7
Protection
 Protection..... 5
 And Features..... 17

Q

Quick Menu..... 8

R

RCD..... 2
 Relay Output..... 18
 Remote Mounting Kit..... 20

S

Slip Compensation..... 10
 Status..... 8
 Surroundings..... 19

T

Thermistor..... 10

U

UL Compliance..... 5

V

VLT

Control Panel LCP 11..... 20

Control Panel LCP 12..... 20

Voltage Level..... 17

W

Warnings And Alarms..... 14



www.danfoss.com/drives

Danfoss can accept no responsibility for possible errors in catalogues, brochures and other printed material. Danfoss reserves the right to alter its products without notice. This also applies to products already on order provided that such alterations can be made without subsequential changes being necessary in specifications already agreed. All trademarks in this material are property of the respective companies. Danfoss and the Danfoss logotype are trademarks of Danfoss A/S. All rights reserved.

