



Operating Instructions

MCB 15x Safety Option

Legal Information and Safety

According to the Machinery Directive regulation, it is hereby stated that the original language of these Operating Instructions is English UK.

Legal Information, Copyright and Revisions

This publication contains information proprietary to Danfoss and is protected by Copyright laws of Denmark, international treaties and most other countries. All trademarks in this publication are property of the respective companies. Danfoss and the Danfoss logotype are trademarks of Danfoss A/S. All rights reserved.

Although Danfoss has tested and reviewed the correctness, completeness and documentation of this publication, Danfoss makes no warranty or representation, neither express or implied, with respect to this publication, including but not limited to its quality, correctness, completeness, performance, or fitness for a particular purpose.

Danfoss reserves the right to revise, update and change this publication at any time without prior notice or specific obligation to inform former or present users of such revisions or changes.

Warranty and Liability

All claims to warranty and liability are rendered invalid if

- the product was used contrary to the purpose for which it is intended
- damage can be attributed to not having followed the guidelines in the manual
- operating personnel are not suitably qualified
- any type of modification has been made (e.g. exchanging components on the PCB boards, soldering work etc.)

Safety

⚠ WARNING

HIGH VOLTAGE!

Frequency converters contain high voltage when connected to AC mains input power. Installation, start up, and maintenance should be performed by qualified personnel only. Failure to perform installation, start up, and maintenance by qualified personnel could result in death or serious injury.

⚠ WARNING

UNINTENDED START!

When the frequency converter is connected to AC mains, the motor may start at any time. The frequency converter, motor, and any driven equipment must be in operational readiness. Failure to be in operational readiness when the frequency converter is connected to AC mains could result in death, serious injury, equipment, or property damage.

⚠ CAUTION

This option is suitable for performing mechanical work on the frequency converter system or affected area of a machine only. It does NOT provide electrical safety. This option should NOT be used as a control for starting and/or stopping the frequency converter. See the requirements for those applications in ISO 12100.

Risk Assessment

CAUTION

The MCB 15x is intended to be part of the safety-related control system of a machine. Before installation, a risk assessment shall be performed to determine whether the specifications of this safety option are suitable for all foreseeable operational and environmental characteristics for the system in which it will be installed.

The system user is responsible for

- the set-up, safety rating and validation of any sensors or actuators connected to the system
- completing a system-level risk assessment and reassessing the system any time a change is made
- providing supposition (as needed for the application) that the system fulfills desired safety rating
- project management and proof testing
- programming the application software and the safety option configurations in accordance with the information in this manual
- access to the control system
- analysing all configuration settings and selecting the proper setting to achieve the required safety rating

Safety Regulations

- Check that the mains supply has been disconnected and that the necessary time has elapsed before removing motor and mains supply plugs and before commencing any repair work
- The [Off] key on the LCP does not disconnect mains supply and must never be used as a safety switch
- Ensure the following in accordance with national and local regulations
 - The equipment must be properly earthed
 - The user must be protected against supply voltage
 - The motor must be protected against overload
- The earth leakage current exceeds 3.5 mA
- Protection against motor overload is not included in the factory setting. If this function is desired, set *1-90 Motor Thermal Protection* to data value [4] *ETR trip 1* or data value [3] *ETR warning 1*
- Do not remove the plugs for the motor and mains supply while the frequency converter is connected to mains

NOTE

The frequency converter has more voltage sources than L1, L2 and L3, when load sharing (linking of DC intermediate circuit) or external 24 V DC are installed.

Qualified Personnel

The products may only be assembled, installed, programmed, commissioned, operated, maintained and decommissioned by persons with proven skills. Persons with proven skills

- are qualified electrical engineers, or persons who have received training from qualified electrical engineers and are suitably experienced to operate devices, systems, plant and machinery in accordance with the general standards and guidelines for safety technology
- are familiar with the basic regulations concerning health and safety/accident prevention
- have read and understood the safety guidelines given in this description and also the instructions given in the *VLT® AutomationDrive Operating Instructions*.
- have a good knowledge of the generic and specialist standards applicable to the specific application

Users of PDS(SR)s are responsible for

- hazard and risk analysis of the application
- identifying safety functions required and allocating SIL or PLr to each of the functions
- other subsystems and the validity of signals and commands from them
- designing appropriate safety-related control systems (hardware, software, parameterisation, etc.)

Warnings and Approvals

▲WARNING

Indicates a potentially hazardous situation which, if not avoided, could result in death or serious injury.

▲CAUTION

Indicates a potentially hazardous situation which, if not avoided, may result in minor or moderate injury. It may also be used to alert against unsafe practices.

CAUTION

Indicates a situation that may result in equipment or property-damage-only accidents.

NOTE

Indicates highlighted information that should be regarded with attention to avoid mistakes or operate equipment at less than optimal performance.

Approvals



Table 1.1

Contents

1 Introduction	4
1.1 Purpose of the Manual	4
1.2 Overview of Documentation	4
1.3 Abbreviations and Definitions	5
2 Functions and System Overview	7
2.1.1 Behaviour of Holding Brake	8
2.1.2 Safety Certification	8
2.1.3 Implementation in Control Systems	8
2.1.4 Specification of Safety Functions	8
2.1.4.1 Performance Level and Safety Integrity Level (SIL)	8
2.1.5 Validation of Performance Level	9
2.1.6 Activation of Safety Functions	9
2.1.7 Simultaneous Activation of Safety Functions	9
2.1.8 Functional Proof Tests	10
2.1.9 PFD and PFH Definitions	10
2.1.10	10
2.1.11 MCT 10 Set-up Software with Safe Plug-in	11
2.2 Unit Features	11
2.3 Front View	11
2.4 Categories of Safe Stop	11
2.4.1 Operation and Requirements	12
2.4.2 Safety Functions	12
2.4.3 Safe Torque Off - STO	12
2.4.4 Safe Stop 1 - SS1	13
2.4.4.1 SS1 Delay	13
2.4.4.2 SS1 Delay with S-ramp Stop Profile	14
2.4.4.3 SS1 Ramp	15
2.4.4.4 SS1 Ramp Slope	15
2.4.4.5 SS1 Ramp time	16
2.4.5 Safely Limited Speed (SLS)	16
2.4.5.1 SLS without Ramp	17
2.4.5.2 SLS with Ramp	18
2.5 Inputs and Output	19
2.5.1 Inputs	19
2.5.2 Reset Input (DI2)	19
2.5.3 Output	19
2.5.4 Permitted Sensors	19
2.5.5 Reset	20

2.5.6 Signal Filtering	20
2.5.7 Stable Signal Time from Safe Outputs	20
2.5.8 Zero Speed Time Error Detection	21
2.5.9 Yearly Test	21
2.5.10 Safety Parameter Settings	21
2.5.11 Encoder Interface	21
2.6 Limitations	22
2.6.1 Exceeded Limit Value and Internal Errors	22
2.6.2 Compatibility between Safety and Frequency Converter Functions	22
3 Installation	23
3.1 Installing the MCB 15x	23
3.1.1 Requirements for Safe Use	23
3.1.2 Protected Cable Installation	23
3.1.3 Installation	23
3.1.4 General Wiring Guidelines	25
3.1.5 Connector Pin Assignment	26
3.2 Encoder	28
3.2.1 Permissible Encoder Cable Length	28
3.2.2 Encoder Wiring Examples	28
3.2.3 Proximity Switch	28
3.3 Application Examples	29
3.3.1 Connecting Safe Digital Inputs	29
4 Commissioning	31
4.1.1 Safety Guidelines	31
4.1.2 Commissioning Requirements	31
4.2 Initial Commissioning	31
4.2.1 Power-up/Self-test	31
4.2.2 Initial Commissioning	32
4.2.3 Safe Option Customisation	32
4.2.4 Setting up the Encoder	32
4.2.5 Commissioning Test	33
4.3 Operation	33
5 General Parameter Set-up	34
5.1 Configuration	34
5.1.1 General Parameter Set-up	34
5.1.2 Parameter Status via Fieldbus	34
5.1.3 Configuration	34
5.1.4 Password Protection	35

5.2 Parameter List	35
6 Service and Repair	41
6.1 Updates, Servicing and Modifications	41
6.2 Repair	41
6.3 Replacing	41
6.3.1 Removing the MCB 15x	41
6.3.2 Replacing the MCB 15x	41
6.3.3 Copying Safe Parameter Set-up	42
6.4 Commissioning Test	46
6.4.1 Safety Guidelines	46
6.4.2 Condition before Performing the Commissioning Test	46
6.4.3 Safety Functions of the Frequency Converter	48
6.5 Disposal	54
7 Reset and Status over Fieldbus	55
7.1.1 Reset of MCB 15x Safe Option and Pending Safe Function	55
7.1.2 Retrieving MCB 15x Safe Option Status	55
8 Warnings and Alarms	57
8.1.1 Messages	57
8.2 Warnings and Alarms	58
8.2.1 Safe Option Warning	65
8.2.2 Safe Option Reset Message	65
9 Technical Specifications	67
9.1.1 Safety Characteristic Data	69
Index	70

1 Introduction

1.1 Purpose of the Manual

NOTE

Retain this documentation for instruction and for future reference.

These Operating Instructions explain the function and operation and provide installation and wiring guidelines for the MCB 15x.

Also refer to the following documents from the motion control range:

- *MCT 10 Set-up Software Operating Instructions* describe the configuration of the MCB 15x.
- *VLT® AutomationDrive Operating Instructions* describe the frequency converter.
- The online help for the MCT 10 Set-up Software describes how to set the parameters for the frequency converter and the MCB 15x.

Be conversant with the information in these documents to fully understand this manual.

1.2 Overview of Documentation

Introduction

Explains the contents, structure and specific order of this manual.

Functions and System Overview

Provides information on the most important product features.

Installation

Explains how to install and wire the product.

Commissioning

Describes how to commission the product.

General Parameter Set-up

Describes the basic parameters for setting.

Service and Repair

Describes how to replace a defective MCB 15x and how to update, service and modify the firmware and the MCB 15x.

Warning and Alarms

Contains a table overview of the warnings and alarms.

Troubleshooting tips are also part of the overview.

Technical Specifications

Specifies the technical details of the MCB 15x.

The manuals listed below contain important information about safety systems that must be used to mount and set up the speed monitoring safety functions of the MCB 15x module.

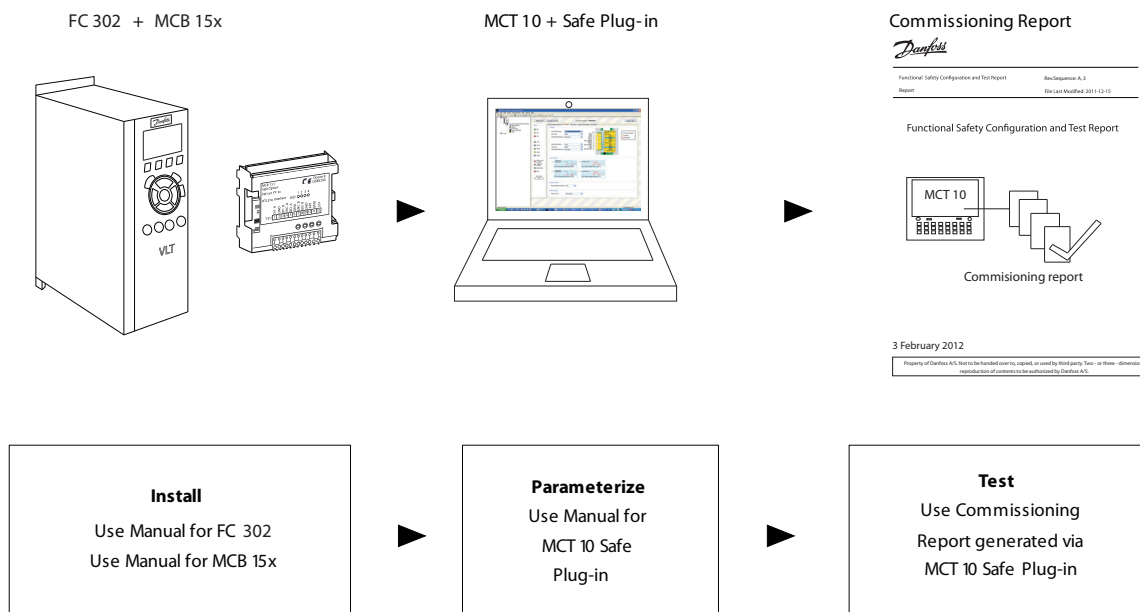

Illustration 1.1 System Overview

Referenced literature

- VLT® AutomationDrive Operating Instructions
- MCT 10 Set-up Software Operating Instruction

Also refer to www.danfoss.com/drives for frequently asked questions and additional information.

1.3 Abbreviations and Definitions

CCW	Counter Clockwise
CW	Clockwise
EMC	Electromagnetic compatibility
Encoder	Sensor for detection of the angular position of a rotating component. Installed on/in a motor, the encoder shows the angular position of the rotor.
Error	Discrepancy between a computed, observed or measured value or condition and the specified or theoretically correct value or condition.
Fatal error	In the case of fatal error, the product is no longer able to control the motor so that the power stage must be immediately disabled.
Fault	Fault is a state that can be caused by an error
Fault reset	A function used to restore the frequency converter to an operational state after a detected error is cleared by removing the cause of the error so that the error is no longer active.
Error class	Classification of errors into groups. The different error classes allow for specific responses to errors, for example by severity.

Parameter	Device data and values that can be read and set (to a certain extent) by the user
PELV	Protective Extra Low Voltage, low voltage with isolation. For more information: IEC 60364-4-41 or IEC 60204-1.
RS-485	Fieldbus interface as per EIA-422/485 Bus Description, which enables serial data transmission with multiple devices.
Degree of protection	The degree of protection is a standardized specification for electrical equipment that describes the protection against the ingress of foreign objects and water (for example: IP20).
PLC	Programmable logic controller
Warning	If the term is used outside the context of safety instructions, a warning alerts to a potential problem that was detected by a monitoring function. A warning is not an error and does not cause a transition of the operating state.
Factory setting	Factory settings when the product is shipped
SLS - Safely limited speed	Safety function in accordance with EN IEC 61800-5-2, monitors the frequency converter to check that it stays within a defined speed limit. SLS is the abbreviation for safely limited speed.
SS1 - Safe stop 1	Safety function in accordance with EN IEC 61800-5-2, ensures that the motor decelerates in the expected way. SS1 is the abbreviation for safe stop 1.

STO - Safe torque off	Safety function in accordance with EN IEC 61800-5-2, prevents torque from being generated by the motor. This function is integrated within the frequency converter as standard. STO is the abbreviation for safe torque off.
OSSD	Output Signal Switching Device (EN 61496-1)
PL/ Performance Level	Discrete level used to specify the ability of safety-related parts of control systems to perform a safety function under foreseeable conditions (EN ISO 13849-1)
SIL	Safety Integrity level (IEC61508, IEC61800-5-2, IEC62061)
TM	Mission Time (EN ISO 13849-1)
MTTF/MTTFd	Mean time to failure/Mean time to dangerous failure (EN ISO 13849-1)
Cat.	Category (EN ISO 13849-1)
CCF	Common Cause Failure (IEC 61508, IEC 62061, EN 61511-1, EN ISO 13849-1)
DC	Diagnostic Coverage (EN ISO 13849-1, IEC 62061(IEC 61508-2))
PFd	Probability of Failure on Demand (IEC 61508, IEC 62061)
PFH	Probability of Failure per Hour (IEC 62061 and IEC61508)
SRECS	Safety Related Electrical Control System (IEC 62061)
PUST	Power Up Self Test. Internal self test on the MCB 15x.
SO	Safe Option (MCB 15x)
Safe state	If a safe state fault is detected, the safety option goes into safe state. This includes faults related to integrity of hardware or firmware.
SRP/CS	Safety related parts of control systems (EN ISO 13849-1)
Dlx	DI1: Digital Input 1 DI2: Digital Input 2
SF	Safe Function
Blank Initial State	Factory settings

Table 1.1 Abbreviations and Definitions

2 Functions and System Overview

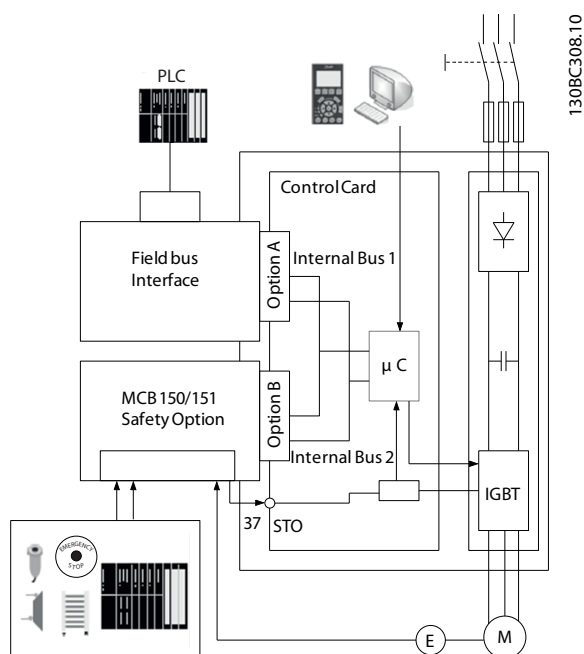

Illustration 2.1 Safe Drive System

The MCB 15x performs safety functions in accordance with EN IEC 61800-5-2. It monitors safe motion sequences on frequency converters, which are safely brought to a stop and shut down in the event of an error.

The MCB 15x is built into a VLT® AutomationDrive FC 302 and requires a signal from a sensor unit. A safe drive system from Danfoss consists of the following

- Frequency converter, VLT® AutomationDrive FC 302
- MCB 15x built into the frequency converter

The MCB 15x

- activates safety functions
- monitors safe motion sequences
- signals the status of safety functions to the safety control system via possible connected Profibus fieldbus
- activates the selected failure reaction Safe Torque Off or Safe Stop 1, in the event of an error

There are 2 variants of the MCB 15x, one with HTL encoder interface (MCB 151) and one with TTL encoder interface (MCB 150).

The MCB 15x Safe Option is constructed as a standard option for the VLT® AutomationDrive FC 302 and is automatically detected after mounting.

The MCB 15x can be used to monitor the stopping, starting or speed of a rotating or laterally moving device. As speed monitor, the option is often used in combination with hard guarding, access doors, and safety gates with solenoid-lock or -unlock safety switches. When the speed of the monitored device drops below the set switch point (where its speed is no longer considered dangerous), the MCB 15x sets S37 output low. This allows the operator to open the safety gate. In speed monitor applications, the safety output S37 is high for operation (when the motor speed of the monitored device is below the set switch point). When the speed exceeds the set value, indicating a too-high (dangerous) speed, the safety output is low.

The frequency converter

- removes the power to the motor,
- switches the motor to torque-free, if Safe Torque Off is activated

The safety control system

- activates the safety functions via inputs on the MCB 15x
- evaluates signals from safety devices, such as
 - E-STOP push buttons
 - Non Contact Magnetic switch
 - Interlocking switch
 - Light curtain devices
- processes the MCB 15x status function
- provides safe connection between MCB 15x and safety control system
- provides fault detection at activation of safety functions (shorts across contacts, short circuit) on signal between the safety control system and MCB 15x

2.1.1 Behaviour of Holding Brake

CAUTION

RISK OF HAZARD!

If external forces act on the motor (vertical axis) and an unwanted movement, for example caused by gravity, could cause a hazard, add measures for fall protection before operating the motor.

Triggering the Safe Torque Off safety function means that the delay time for motors with holding brake is not effective. The motor cannot generate holding torque to bridge the time to application of the holding brake. Check whether additional measures have to be taken; for example, this may cause the load of vertical axes to lower.

2.1.2 Safety Certification

The MCB 15x is certified for use in safety applications up to and including SIL 2 according to EN IEC 61508 and EN IEC 62061, Performance Level PL d and Category 3 according to EN ISO 13849-1. Safety requirements are based on the standards current at the time of certification. The IFA (Institute for Occupational Safety & Health) has

approved the MCB 15x for use in safety-related applications where the de-energised state is considered to be the safe state. All of the examples related to I/O included in this manual are based on achieving de-energisation as the safe state.

2.1.3 Implementation in Control Systems

In many cases design measures are not sufficient and protective devices are needed to minimise risk. In this context, safety functions executed by SRP/CS (safety related parts of control systems) are defined. SRP/CS includes the entire safety chain with sensor (detect), logic (process) and actuator (switch).

Safety functions are defined on the basis of both the application and the hazard. They are often specified in a Type C standard (a product standard) which provides precise specifications for special machines. If a C standard is not available, the machine designer defines the safety functions. Typical safety functions are described in more detail in EN ISO 13849-1, section 5, *Specification of Safety Functions*. The safety functions for frequency converter systems are described in IEC 61800-5-2.

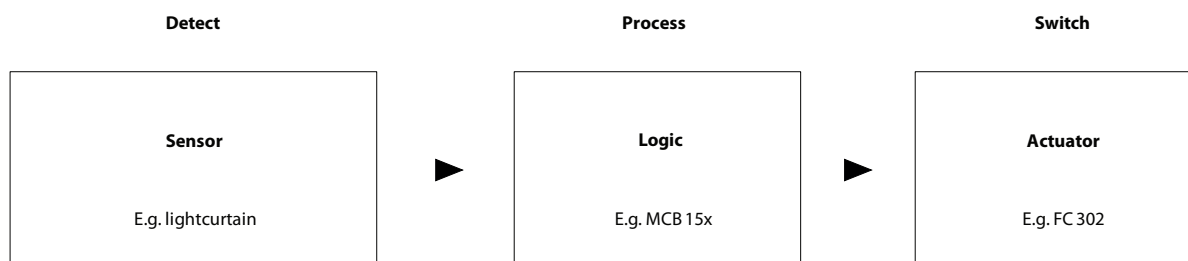

1308C962.10

Illustration 2.2 Sensor-Logic-Actuator Safety Chain

2.1.4 Specification of Safety Functions

The standards require a specification of functional requirements. The specification must contain details about each safety function that should be executed. Also define the

- necessary interfaces with other control functions
- required error responses
- performance level required PLr or achievable SIL level

2.1.4.1 Performance Level and Safety Integrity Level (SIL)

For safety-related control systems, Performance Level (PL), according to EN ISO 13849-1, and SIL levels, according to EN IEC 61508 and EN IEC 62061, include a rating of the system's ability to perform its safety functions. All of the safety-related components of the control system must be included in both a risk assessment and the determination of the achieved levels. Refer to EN ISO 13849-1, EN IEC 61508 or EN IEC 62061 standards for complete information on requirements for PL and SIL determination.

2.1.5 Validation of Performance Level

Check whether the required Performance Level "PLr", determined in the risk assessment, is achieved by the selected system for each safety function used.

Check the calculation using the SISTEMA SW Tool of IFA (Institute for Occupational Safety & Health). Danfoss provides a component library which can be used for the calculation. Danfoss offers corresponding services to support the system check by calculation. Library can be downloaded from <http://www.dguv.de/ifa/en/pra/software/sistema>.

If using another validation method for the performance level, use the characteristic safety values specified.

If two equal safety functions have to be configured, they must be parameterised as SS1-a and SS1-b or SLS-a and SLS-b.

2.1.6 Activation of Safety Functions

- The safety functions are activated using the dual-pole safe inputs on the MCB 15x.
- These inputs operate in accordance with the fail-safe principle (on switching off). The safety control system activates the safety functions via a 1/0 transition.
- Deactivate the safety functions before applying any changes to them.

2.1.7 Simultaneous Activation of Safety Functions

All safety functions can be active at the same time. However, Safe Torque Off has priority over all other safety functions. Functions already started (e.g. Safe Stop 1 or Safely Limited Speed) are canceled and the frequency converter coasts.

- Safe Torque Off has the highest priority. If the Safe Torque Off function is triggered, a Safe Torque Off is managed no matter what other functions are active.
- Safe Stop 1 has medium priority to the other safe functions.
- Safely Limited Speed has the lowest priority.

If two Safe Stop 1 functions are active at the same time, the function with the steepest ramp has higher priority than the function with less steep ramp.

If two Safely Limited Speed functions are active at the same time, the function with the lowest speed limit has higher priority than the function with higher speed limit.

2

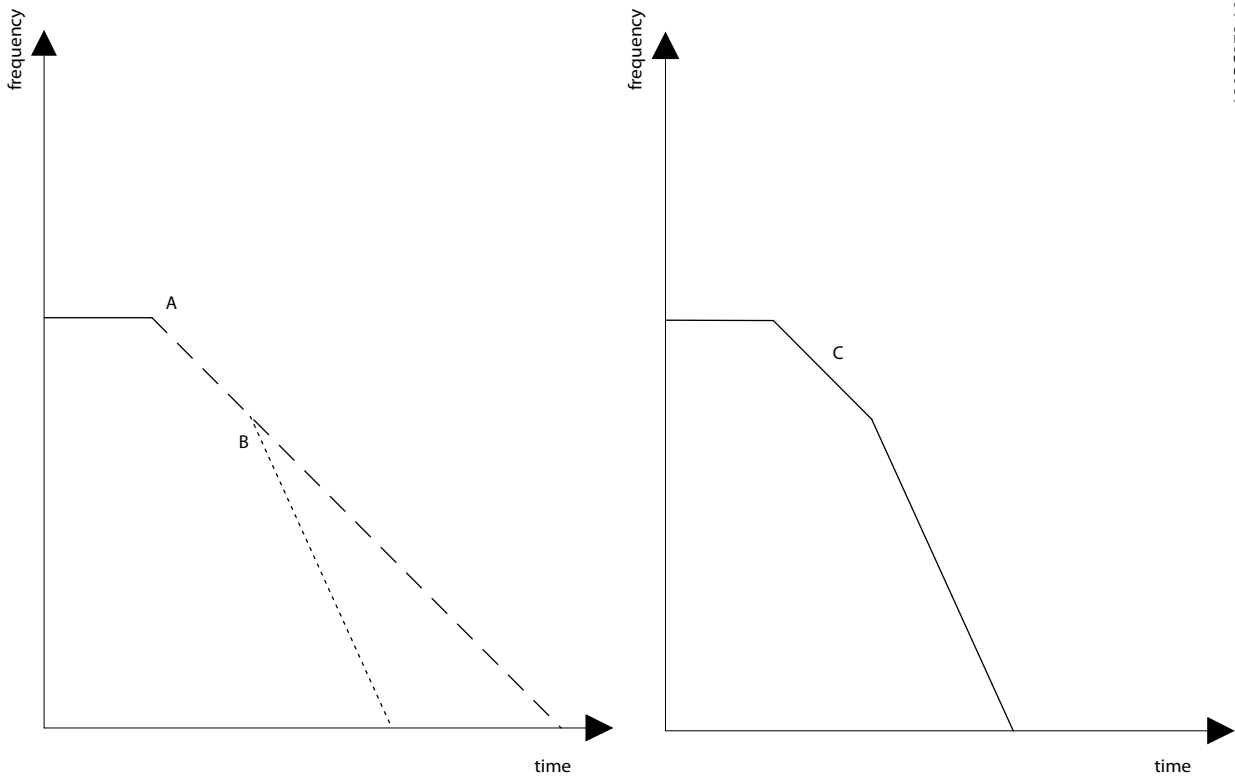

130BC373.10

Illustration 2.3 Two Safe Stop 1 Safety Functions Active

A	Ramp stop function 1
B	Ramp stop function 2
C	Actual ramp stop function

Table 2.1 Legend to Illustration 2.3

Illustration 2.3 shows the result of activating first a Safe Stop 1 function with a given ramp and afterwards activating a second Safe Stop 1 ramp with a steeper ramp. The graph shows the actual ramp function.

2.1.8 Functional Proof Tests

The functional safety standards require that functional proof tests are performed on the equipment used in the system. Proof tests are performed at user-defined intervals and are dependent on PFD and PFH values.

2.1.9 PFD and PFH Definitions

Safety-related systems can be classified as operating in either a Low Demand mode, or in a High Demand/Continuous mode.

Low demand mode

The frequency of demands for operation made on a safety-related system is no greater than once per year.

High Demand/Continuous mode

The frequency of demands for operation made on a safety-related system is greater than once per year.

The SIL value for a low demand safety-related system is directly related to order-of-magnitude ranges of its average probability of failure on demand (PFD). The SIL value for a High Demand/continuous mode safety-related system is directly related to the probability of a dangerous failure per hour (PFH).

CAUTION

RISK OF PERSONAL INJURY AND EQUIPMENT DAMAGE!

To avoid personal injury and equipment damage, only use the MCB 15x for its intended purpose.

The following is considered as improper use

- any component, technical or electrical modification to the frequency converter
- use of the frequency converter outside the allowed electrical and environmental conditions specified in 9 Technical Specifications and in the VLT® AutomationDrive Operating Instructions.

The MCB 15x is designed for use in safety-related applications. It meets the requirements for safety functions in accordance with IEC 61800-5-2, regarding safe motion monitoring.

2.1.11 MCT 10 Set-up Software with Safe Plug-in

Use MCT 10 Set-up Software to configure the safety functions supported in MCB 15x.

- Configuration of the safety functions is required for safe motion sequences. In the event of an error or fault, these functions will shut down the frequency converter's power element in a safe and controlled way.
- Setting of limit values, braking ramps for the safety functions, monitoring of motion sequences.

The software

- Runs in full with a license key. All functions are available from MCT 10 Set-up Software version 3.18.
- Supports the configuration of applications with up to max. 256 safety options per project
- Has a simple language setting for the user interface

A PDF file and a commissioning report can be generated for documentation of the project and all its settings.

2.2 Unit Features

The MCB 15x has the following features

- 2 Dual-pole, digital inputs to activate the safety functions in accordance with EN IEC 61800-5-2
 - Safe Torque Off (STO)
 - Safe Stop 1 (SS1)
 - Safely Limited Speed (SLS)
- Reset function
 - Digital input 2 can be used for resetting the MCB 15x after an error or after deactivation of a safety function.
- Status indicators
 - Safe output status (LED 4)
 - Safe input status (LED 1 and LED 2)
 - LED 3 reserved for future use (always in off state)
 - By Fault or warning the LEDs indicate a failure via flash pattern, see *Table 8.2*
- Supply voltage
 - Internally supplied by the frequency converter.
 - 24 V DC output for safety sensors and encoder available.

2.3 Front View

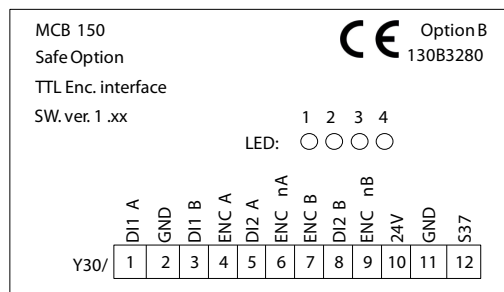

130BC306.10



Illustration 2.4 MCB 150

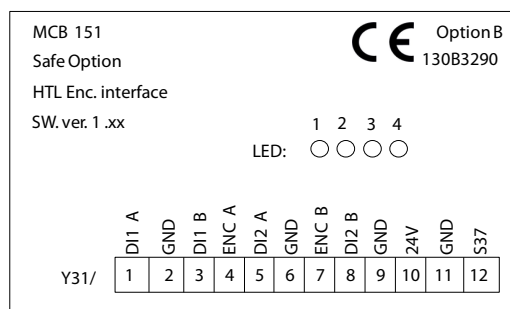

130BC307.10

Illustration 2.5 MCB 151

2.4 Categories of Safe Stop

International standard EN/ISO 13850 specifies the functional requirements and design principles of emergency stop devices.

It applies to all machines, whatever type of energy is used to control this function.

The standard allows two types of stop

- Category 0 stop: Stopping by immediately cutting-off power or mechanical disconnection between the dangerous components
- Category 1 stop: Controlled stopping with power maintained to the actuator to achieve stopping (braking for example), then cut-off of power when zero speed is reached.

During a category 0 stop, the motor coasts down in an uncontrolled way. If access to the machine coasting down involves a hazard (results of the hazard and risk analysis), take protective measures to avoid the hazard.

Refer to EN IEC 61800-5-2:2007 (4.2.2.2) for a definition of Safe Torque Off (STO).

A Category 1 stop triggers a controlled stop. The MCB 15x monitors the controlled stop. If a power outage or an error occurs, a controlled stop is impossible. Trigger the safety function Safe Torque Off after the stop to shut off the motor torque.

Refer to EN IEC 61800-5-2:2007 (4.2.2.3) for a definition of Safe Stop 1 (SS1).

An evaluation of the machine-related risks determines which of the two stopping methods to use.

NOTE

When designing the machine application, consider timing and distance for a coast to stop (Stop Category 0 or Safe Torque Off). For more information regarding stop categories, refer to EN IEC 60204-1.

2.4.1 Operation and Requirements

The MCB 15x is redundant and self-checking. It requires digital input signals from an input sensor (e.g., PNP proximity switch) or higher resolution TTL or HTL encoders to monitor for either safe stop or speed conditions.

2.4.2 Safety Functions

Safety functions maintain a safe condition or prevent hazardous conditions from arising. The safety functions for frequency converters are defined in EN IEC 61800-5-2.

The MCB 15x implements the following safety functions

- Safe Torque Off (STO)
 - No power is being fed to the motor which can generate a rotation. Stop category 0 to EN IEC 60204-1
- Safe stop 1 (SS1)
 - Motor decelerates. Monitoring of deceleration ramp and Safe Torque Off following zero speed, or Safe Torque Off at the end of a deceleration time. Stop category 1 to EN IEC 60204-1
- Safely limited speed (SLS)
 - Prevents exceeding a defined speed value

2.4.3 Safe Torque Off - STO

The safety function Safe Torque Off disconnects power to the motor. It is implemented via the frequency converter's shutdown path and the MCB 15x safe outputs.

Features of the safety function

- The motor becomes torque-free and no longer generates any hazardous movements
- To prevent the frequency converter from running down in an uncontrolled manner, in normal operation the safety function Safe Torque Off is activated via the safety function Safe Stop 1
- Safe Torque Off is only activated directly when
 - There is an internal error on the MCB 15x
 - The Safe Stop 1 delay time is set to 0
 - One of the inputs DI1 or DI2 has been selected as Safe Torque Off function
- The safety function Safe Torque Off corresponds to a category 0 stop (uncontrolled stop) in accordance with EN IEC 60204-1.

Prerequisites for normal operation

- Input DI1 or DI2: "1" Signal (+24 V DC)
- S37 output: "1" Signal (+24 V DC). The MCB 15x is ready for operation

Safety function is activated

- By an error after limit values have been exceeded for Safe Stop 1 and Safely Limited Speed or
- By an internal error on the MCB 15x or frequency converter, if the frequency converter can no longer be controlled

- By executing the safety function Safe Stop 1 (1/0 transition). In this case the frequency converter is monitored before it is switched to torque-free.
- By download of parameterisation via MCT 10 Safe Plug-in if the current frequency converter is running.
- By executing the safety function Safe Torque Off (1/0 transition). This function ensures that no torque-generating energy can continue to affect a motor and prevents unintentional start-ups.

⚠ WARNING

If any external forces influence the motor axis (e.g. suspended loads), additional measures (e.g. a safety holding brake) are required in order to eliminate hazards.

The Safe Torque Off (STO) may be used where power removal is required to prevent an unintended start. The function disables the control voltage of the frequency converter output stage. Thus it prevents the frequency converter from generating the voltage required to rotate the motor (see *Illustration 2.6*). The function allows for performing maintenance work on non-electrical parts of the machinery without switching off the power supply to the frequency converter.

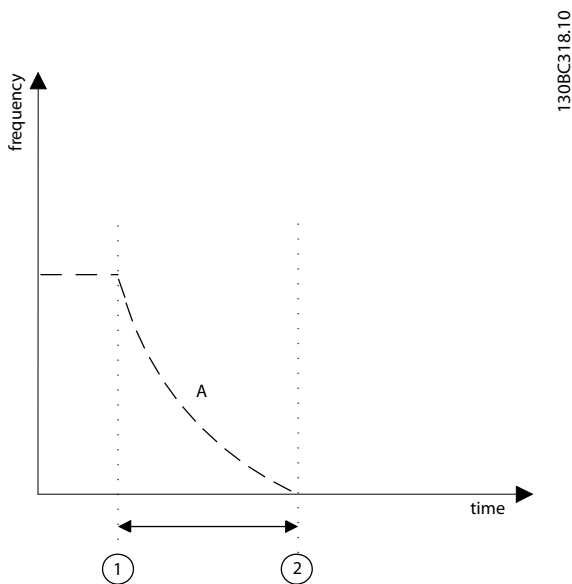

Illustration 2.6 Safe Torque Off

A	Actual frequency
1	Activation of Safe Torque Off
2	Motor standstill

Table 2.2 Legend to *Illustration 2.6*

2.4.4 Safe Stop 1 - SS1

The safety function Safe Stop 1 monitors the deceleration to zero speed in a controlled manner and activates Safe Torque Off after detection of stop. The Safe Stop 1 can either be configured as SS1 Delay or SS1 Ramp.

Features of the Safety Function

- The safety function Safe Stop 1 corresponds to a category 1 stop (controlled braking) in accordance with EN IEC 60204-1
- Monitoring the speed deceleration after which the energy supply to the motor is safely interrupted
- The motor becomes torque-free and removes hazardous movements

2.4.4.1 SS1 Delay

Select SS1 Delay to activate Safe Stop 1 function while a parameterised safety delay timer expires.

Safe Torque Off is activated immediately when the configured Stop Delay has expired, regardless of speed.

Selecting the SS1 Settings

1. Enter *42-41 Ramp Profile*
2. Select
 - *[0] Linear*, if the ramp must follow a linear curve
 - *[2] S-ramp Const Time*, if the ramp should follow an S-ramp

By using SS1 Delay, the frequency converter attempts to follow the selected ramp. After a specified delay time, Safe Torque Off is activated and the motor is made torque free.

⚠ CAUTION

Using SS1 Delay may result in the motor still spinning when the Safe Torque Off is activated. The risk analysis for the machine must indicate that this behaviour can be tolerated. An interlock may be required.

Default value in *42-40 Type* is *[0] Delay*. If this value is selected, the Safe Stop 1 function activates a braking ramp defined from a selected time delay in *42-42 Delay Time*. This means that the braking ramp is linear. Type the value of *42-43 Delta T*, which is a reasonable tolerance after the SS1 Delay Time has expired.

By selecting SS1 Delay, the Safe Stop 1 function is active while a parameterised safety delay timer expires.

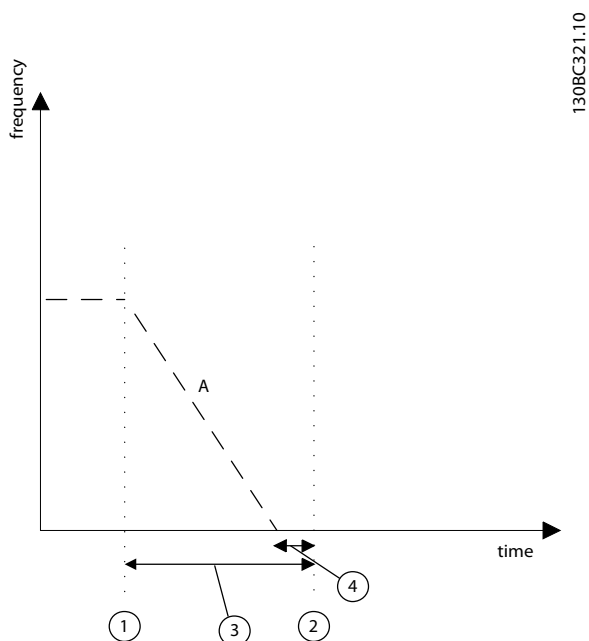

130BC321.10

Illustration 2.7 SS1 Delay

A	Actual frequency
1	Activation of SS1 Delay Timer
2	Activation of Safe Torque Off
3	42-42 Delay Time
4	42-43 Delta T

Table 2.3 Legend to Illustration 2.7

NOTE

The Safe Stop 1 function (SS1 Delay) does not monitor the stopping of the frequency converter!

The safety relevant time Δt allows the frequency converter to come to a stop before Safe Torque Off is activated. Thus ensuring that the system is also stopped before Safe Torque Off is activated. If a fault occurs, the frequency converter does not come to a stop. It coasts after the time delay no matter of the speed of the frequency converter.

When Safe Stop 1 function is active, the frequency converter brings the motor to zero speed. The Safe Torque Off function is triggered after a specified safety-relevant time. This safety function corresponds to a controlled stop of the frequency converter according to EN IEC 60204-1, stop category 1.

2.4.4.2 SS1 Delay with S-ramp Stop Profile

An S-ramp gives non-linear acceleration, compensating for jerks in the application.

1. Define a speed profile by a delay (a "worst case" delay from actual frequency to zero speed) and a delay tolerance. The safety relevant time Δt allows the frequency converter to come to a stop before Safe Torque Off is activated. Thus ensuring that the system is also stopped before Safe Torque Off is activated. If a fault occurs, the frequency converter does not come to a stop. It coasts after the time delay no matter the frequency converter speed.
2. Define and save an S-ramp configuration, which achieves zero speed within the delay.
3. Configure the S-Ramp ratio at deceleration start in 42-48 S-ramp Ratio at Decel. Start and set 42-49 S-ramp Ratio at Decel. End for S-Ramp ratio at deacceleration end.

Parameter	Unit	Range	Default
42-42 Delay Time	s	0.1-1800.0 s	1.0 s
42-43 Delta T	%	0-50%	5%
42-48 S-ramp Ratio at Decel. Start	%	1-99	50
42-49 S-ramp Ratio at Decel. End	%	1-99	50

Table 2.4 Parameters for SS1 Delay with S-ramp Stop Profile

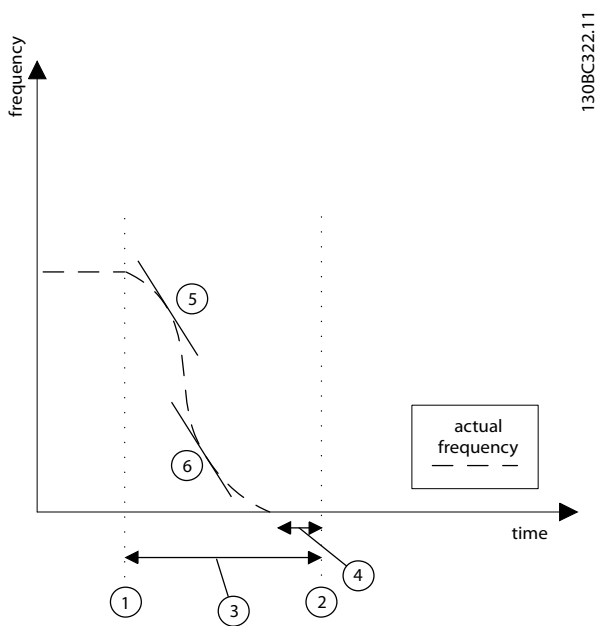

Illustration 2.8 SS1 Delay with S-ramp Stop Profile

A	Actual frequency
1	Activation of SS1 Ramp Delay
2	Activation of Safe Torque Off
3	42-42 Delay Time
4	42-43 Delta T
5	42-48 S-ramp Ratio at Decel. Start
6	42-49 S-ramp Ratio at Decel. End

Table 2.5 Legend to Illustration 2.8

2.4.4.3 SS1 Ramp

NOTE

The SS1 Ramp function can only be used when an encoder is connected to the MCB 15x.

This Safe Stop type allows access to the hazard area immediately after motion is detected as stopped rather than waiting until a specific time has elapsed.

The MCB 15x monitors the following functions

- Braking ramp

In the MCT 10 Set-up Software Safe Plug-in, the braking ramp is specified and monitoring is activated. The braking period depends on the speed of the motor when braking is started. The braking ramp can be monitored via a maximum speed error specified in the MCT 10 Set-up Software in 42-45 Delta V.

- Braking ramp in normal operation

The frequency converter starts with the configured braking ramp when safety function Safe Stop 1 has been activated. Once the speed is at zero speed limit, Safe Torque Off is activated.

- Safety function Safe Torque Off is activated when the configured limit value for the position error is exceeded

A standstill threshold Zero speed (42-46 Zero Speed) for activating the safety function Safe Torque Off can be specified in MCT 10 Set-up Software.

Safety function Safe Torque Off is activated when zero speed is achieved.

Prerequisites for normal operation

- Input DI1 or DI2: "1" Signal (+24 V DC)
- S37 output: "1" Signal (+24 V DC). The MCB 15x is ready for operation

A 1/0 transition at the selected DI1 or DI2 input activates the safety function.

Signal status of the inputs DI1 and DI2

The Safe Stop 1 ramp starts when one of the two inputs is set to "0". The safety function Safe Torque Off is activated once the braking ramp has reached zero speed.

2.4.4.4 SS1 Ramp Slope

For the stopping process, the MCB 15x initiates a stop signal to the frequency converter and monitors the controlled braking by monitoring the braking ramp. The admissible deceleration ramp is specified in 42-44 Deceleration Rate. The frequency converter must decelerate at least with the steepness of this deceleration ramp in the event of a Safe Stop 1 request from the MCB 15x, even under heavy load. If the frequency converter does not fulfill the admissible deceleration ramp during a Safe Stop 1 requested by the MCB 15x, a Safe Torque Off is triggered immediately. The motor then performs an uncontrolled stop. This action prevents the frequency converter from continuing to run or even accelerating in the event of an error.

Parameter	Unit	Range	Default
42-44 Deceleration Rate	/s	1-30000 s	1500 s
42-45 Delta V	RPM	1-10000 RPM	120 RPM
42-46 Zero Speed	RPM	1-600 RPM	10 RPM

Table 2.6

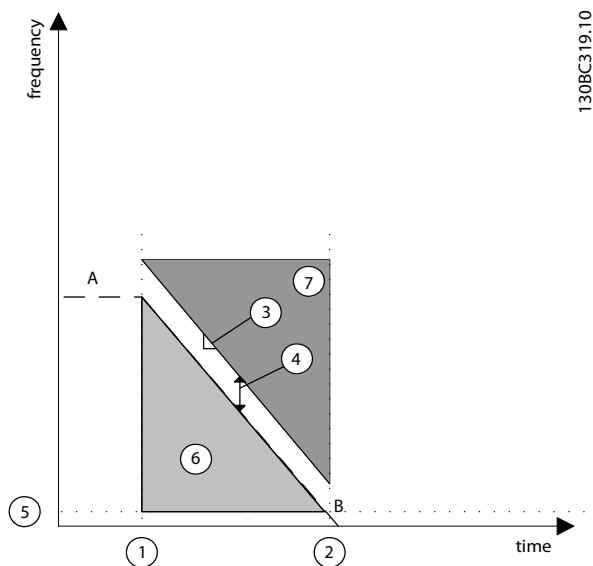

130BC319.10

Illustration 2.9 SS1 Ramp Slope

A	Actual frequency
B	SS1 Ramp
1	Activation of SS1 Ramp Slope
2	Activation of STO
3	42-44 Deceleration Rate
4	42-45 Delta V
5	42-19 Zero Speed Limit
6	Safety function monitors
7	Activation of failure function

Table 2.7 Legend to Illustration 2.9

When the Safe Stop 1 function is active, the frequency converter brings the motor to zero speed. The deceleration is monitored. If the monitored deceleration is slower than expected or at zero speed, Safe Torque Off is triggered.

This safety function corresponds to a controlled stop of the frequency converter according to EN IEC 60204-1, stop category.

2.4.4.5 SS1 Ramp time

Define a speed monitoring profile by a deceleration time and a tolerance (Δv).

Parameter	Unit	Range	Default
42-47 Ramp Time	s	0.1 - 1800.0 s	1.0 s
42-45 Delta V	RPM	1 - 10000 RPM	120 RPM
42-46 Zero Speed	RPM	1 - 600 RPM	10 RPM

Table 2.8 Parameters for SS1 Ramp Time

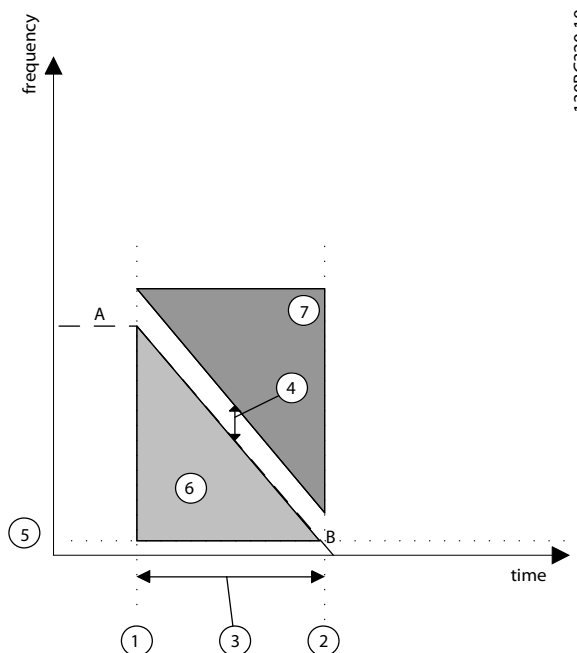

130BC320.10

Illustration 2.10 SS1 Ramp Time

A	Actual frequency
B	SS1 ramp
1	Activation of SS1 Ramp Time
2	Activation of STO
3	42-44 Deceleration Rate
4	42-45 Delta V
5	42-19 Zero Speed Limit
6	Safety function monitors
7	Activation of failure function Safe Torque Off

Table 2.9 Legend to Illustration 2.10

2.4.5 Safely Limited Speed (SLS)

NOTE

The Safely Limited Speed function can only be used when an encoder is connected to the MCB 15x.

This function is used to limit a machine speed. The main goal is to monitor the motor speed and to adjust the speed to a set point. There are two types of Safely Limited Speed

- SLS without Ramp: Monitors the motor speed and, depending on the setting of 42-52 Fail Safe Reaction, trips in Safe Torque Off or Safe Stop 1 if an over speed occurs
- SLS with Ramp: Limits the motor speed to a set point and, depending on the setting of 42-52 Fail Safe Reaction, trips in Safe Torque Off or Safe Stop 1, if an over speed occurs

The Safe Limited Speed is given as Speed limit in 42-51 Speed Limit. The value for the Cut Off Speed partly depends on the motor that is being used. A suggested value from MCT 10 Set-up Software calculates a value for which Danfoss guarantees functionality. This value is called delta speed Limit and is added to the selected speed limit and suggested as value in 42-50 Cut Off Speed.

2.4.5.1 SLS without Ramp

The safety function Safely Limited Speed monitors whether a specified velocity value is exceeded since it was activated via DI1 or DI2. The function is active until the selected input has been put to high again.

If 2 Safe Speed limits must be monitored, set one of the 2 Safe Digital Inputs DI1 or DI2 in 42-20 Safe Function to SLS-a or SLS-b. Then select the input type under 42-21 Type.

The Cut Off Speed represents the maximum allowed frequency of the actual motor frequency. If the motor frequency accelerates above that value, the MCB 15x enters External Fault Selected (STO or SS1 Ramp), and the error is given. The frequency value at which a shutdown is realized should be parameterised in 42-50 Cut Off Speed.

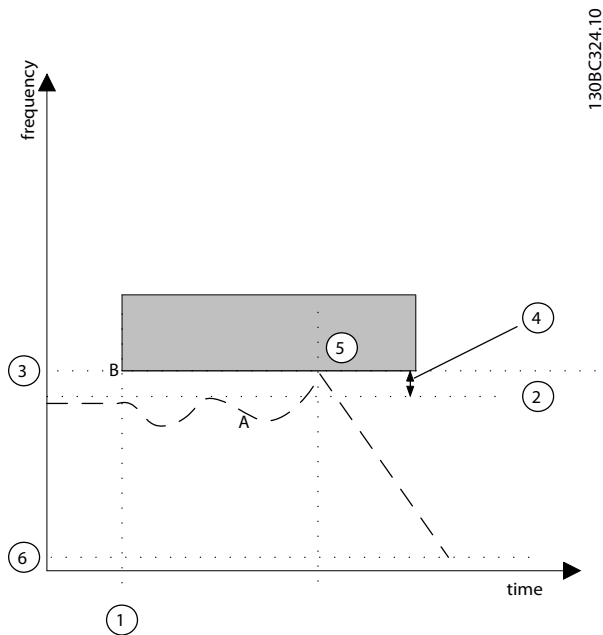

Illustration 2.11 SLS without Ramp

A	Actual frequency
B	SLS limit
1	SLS is activated
2	42-51 Speed Limit
3	42-50 Cut Off Speed
4	Delta speed limit
5	Activation of failure function set in 42-52 Fail Safe Reaction
6	Fixed value of 120 RPM in 42-19 Zero Speed Limit

Table 2.10 Legend to Illustration 2.11

Parameter	Unit	Range	Default
42-50 Cut Off Speed	RPM	1-10000 RPM	270 RPM
42-51 Speed Limit	RPM	1-9999 RPM	150 RPM
42-52 Fail Safe Reaction	n/a	Safe Torque Off/ Safe Stop 1	Safe Torque Off

Table 2.11 Parameters for SLS without Ramp

If speed exceeds the limit, 42-52 Fail Safe Reaction is activated. The safety function can either be Safe Torque Off or SS1 Ramp Time. Safe Stop 1 can only be triggered as error response if one Safe Stop 1 function has been set as as Safe Stop 1 with ramp time function, set in 42-40 Type.

Safe jog in combination with SLS

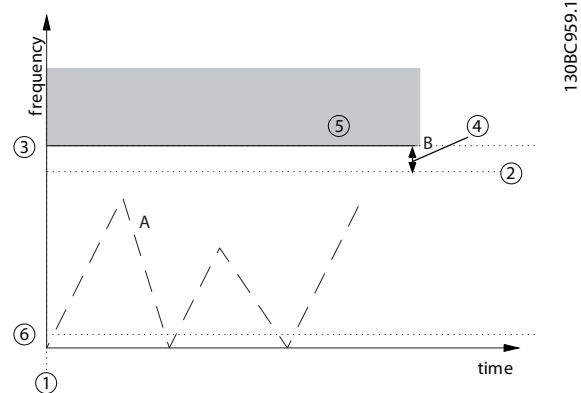

Illustration 2.12 Safe Jog

A	Actual frequency
B	SLS limit
1	SLS is activated
2	42-51 Speed Limit
3	42-50 Cut Off Speed
4	Delta speed limit
5	Activation of failure function set in 42-52 Fail Safe Reaction
6	Fixed value of 120 RPM in 42-19 Zero Speed Limit

Table 2.12 Legend to Illustration 2.12

Access under specific conditions of reduced risk

Under specific conditions of reduced risk, safe jog allows for access to areas for fault-finding, commissioning, etc. On machines where safe jog (jogging or inching) is needed, this is also possible from zero speed setpoint.

By activating Safely Limited Speed, the motor can be moved at safe jog resulting in a number of cycles and with safely monitored movements. The motor can be started and stopped continuously also from zero speed.

2.4.5.2 SLS with Ramp

If this safety function is needed, configure the MCB 15x for Safely Limited Speed (SLS). When the inputs DI1 or DI2 are selected as SLS, input is OFF, feedback velocity is monitored and compared against a configurable safe speed limit.

Select 42-53 *Start Ramp* to configure an SLS Monitoring Ramp. The delay begins when SLS monitoring is requested by the selected input for SLS transition from ON to OFF. The MCB 15x begins monitoring for safe limited speed when the delay times out. If the system speed exceeds or is equal to the configured safe speed limit during Safely Limited Speed monitoring, a Safely Limited Speed fault occurs and the MCB 15x initiates the configured Safe Stop type selected in 42-52 *Fail Safe Reaction*.

Follow these steps to configure the Safely Limited Speed operation

1. If a safe speed limit must be monitored, set one of the 2 safe digital inputs, DI1 or DI2, to [1] *SLS-a* or [2] *SLS-b* in 42-20 *Safe Function*.
2. Select input type in 42-21 *Type*.
3. Select 42-53 *Start Ramp* to run Safely Limited Speed with monitored braking ramp. The default value is [0] *No* for applications without SLS Ramp control.
4. Set the time allowed to reach Safe Limited Speed in 42-54 *Ramp Down Time*.

When the MCB 15x actively monitors Safely Limited Speed, and the motor speed is at or below the configured safe speed limit, the function monitors the speed until the function is deactivated.

5. Set the value in 42-50 *Cut Off Speed*.

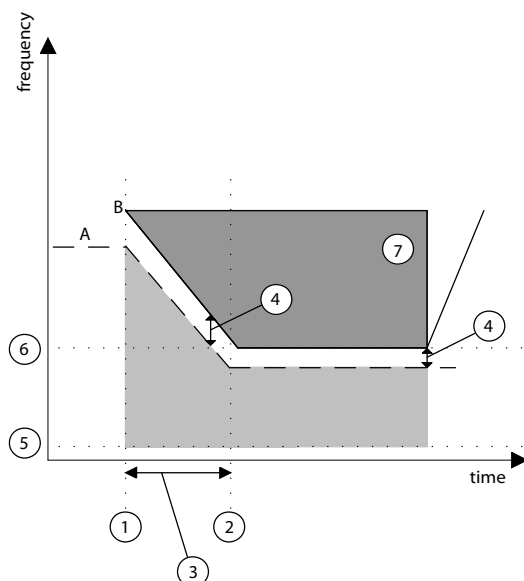

130BC323.10

Illustration 2.13 SLS with Ramp

A	Actual frequency
B	SLS limit
1	Safely Limited Speed is activated with SS1 Ramp Time
2	Safely Limited Speed speed limit reached
3	Ramp down time
4	Delta speed limit
5	Zero speed limit, fixed value of 120 RPM
6	Cut-off speed
7	Activation of failure function set in 42-52 <i>Fail Safe Reaction</i>

Table 2.13 Legend to Illustration 2.13

Activation of failure function set in 42-52 *Fail Safe Reaction*.

Parameter	Unit	Range	Default
42-50 Cut Off Speed	RPM	1-10000 RPM	270 RPM
42-51 Speed Limit	RPM	1-9999 RPM	150 RPM
42-52 Fail Safe Reaction	n/a	Safe Torque Off/ Safe Stop 1	Safe Torque Off
42-53 Start Ramp	n/a	No/Yes	No
42-54 Ramp Down Time	s	0.1-3600.0 s	1.0 s

Table 2.14 Parameters for SLS with Ramp

If the speed exceeds the limit, 42-52 *Fail Safe Reaction* is activated. The safety function can either be Safe Torque Off or SS1 Ramp Time. SS1 can only be triggered as error response if one digital input is selected as SS1 with ramp time function, set in 42-40 *Type*.

Select 42-53 *Start Ramp* if the delay begins when the selected input for Safely Limited Speed transition from ON to OFF requires Safely Limited Speed monitoring.

The ramping begins at the absolute value of the actual speed. If the actual speed is already below the Safely

Limited Speed limit, the limit comes into effect immediately without ramping. When the Safely Limited Speed function is deactivated, the speed limits are ramped up back to the values defined in parameter group 3-7* *References*, and the actual speed returns to the reference value if it was limited by this function.

2.5 Inputs and Output

An internal diagnostic function in the MCB 15x cyclically tests the correct function of the output. A detected fault sets the MCB 15x into an alarm status. At the same time, the option output S37 goes low.

Shorts between the two lines of a dual channel input are not detected. Therefore the cables of the channels must be routed separately to exclude short circuits.

NOTE

Routing of the sensor cables

All initiator/encoder cables must be shielded when laid. The shielding must be connected to chassis at both ends.

2.5.1 Inputs

The Dual-pole digital inputs are used to activate the safety functions. Digital Input 1 can be

- STO: Safe Torque Off
- SS1: Safe stop 1
- SLS: Safely limited speed

Signals at the input

- 1/0 transition at the input: Safety function is activated
- "0" signal (0 V) at the input: Safety function is activated
- "1" signal (+24 V) at the input: Safety function is not activated

Digital Input 2 can be

- STO: Safe Torque Off
- SS1: Safe stop 1
- SLS: Safely limited speed
- Reset: Additional safe input to reset the MCB 15x after an error, or after resetting the option after deactivating a safety function on input DI1

Signals at the input

- 1/0 transition at the input: Safety function is activated
- "0" signal (0 V) at the input: Safety function is activated
- "1" signal (+24 V) at the input: Safety function is not activated
- 0/1 transition at the DI2 input if configured to reset: The MCB 15x is reset

2.5.2 Reset Input (DI2)

The reset input is for resetting the safety circuit selected on DI1. Configure the reset input for automatic or manual reset types. If manual reset is configured, wire the DI2A reset input terminal to a 24 V DC via an NO switch.

2.5.3 Output

Safe, single-pole output

S37 is the output that goes to the Safe Torque Off input of the frequency converter.

- Safe Torque Off Acknowledge
 - Internal error on frequency converter or MCB 15x
 - Limit values exceeded
 - Activated via SS1
 - PUST
 - External failure

2.5.4 Permitted Sensors

The following sensor types are applicable

- sensors with two NC contacts
- antivalent contacts (1 NO contact and 1 NC contact)
- sensor output of type 2xPNP

Sensors with two NO contacts are not applicable.

The safe digital inputs are configured for both directly connecting safety sensors, e.g. emergency stop control devices or light curtains, as well as for connecting pre-processing safety relays, e.g. safe controls. See examples of connecting the safe digital input, in accordance with EN ISO 13849-1 and EN IEC 62061 in 3.3.1 *Connecting Safe Digital Inputs*.

2.5.5 Reset

CAUTION

Both safety inputs must be off after an input fault or PUST has occurred, before a reset is accepted to branch into safe monitoring again.

This reset must only be possible at the location where the command has been initiated.

To operate the MCB 15x, the application must send a reset signal either via the LCP, via a dedicated digital input or via a control word. When a safety function has been activated, or an external failure has caused a failure state, a reset is necessary to enable the safety option again. When the connected sensor on DI1 or DI2, or both is enabled via a reset, the MCB 15x can be switched on again. This deactivates active safety functions or errors.

NOTE

First, trip alarms displayed on the frequency converter must be acknowledged after which a pending safety function can be acknowledged. A single reset for the alarm mode and a single reset for acknowledgment of the active safety function. Alarms caused by the frequency converter must be reset before an alarm can be reset on the MCB 15x.

2.5.6 Signal Filtering

If a sensor with 2NC or 1NC/NO is selected, the MCB 15x checks the signals of the safe digital input for consistency. Consistent signals at both inputs always assume the same signal state (high or low). If 1NC/1NO is selected, it checks the right state of each input.

With electromechanical sensors (e.g. emergency stop buttons or door switches), the two sensor contacts never switch at the same time (discrepancy). A long-term discrepancy points towards a fault in the wiring of a safe input, for example, a wire break. An adjustable filter in the MCB 15x prevents faults caused by temporary discrepancy. Within the filter tolerance time *42-22 Discrepancy Time*, the MCB 15x suppresses the discrepancy monitoring of the safe inputs.

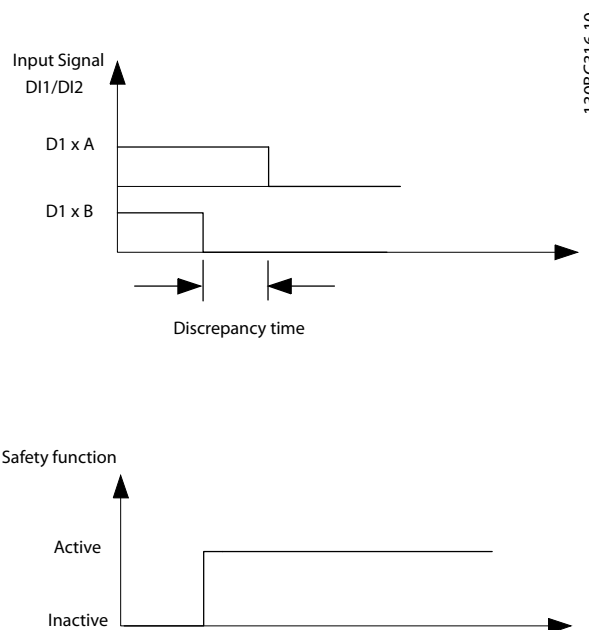

Illustration 2.14 Discrepancy Time

Parameterise the discrepancy time of the switching elements connected to the DIs. The default value is 10 ms.

NOTE

The discrepancy time does not extend the MCB 15x response time. The MCB 15x activates its safety function as soon as one of the two DI signals changes from high to low.

2.5.7 Stable Signal Time from Safe Outputs

The MCB 15x normally responds immediately to signal changes at its safe input DI1 or DI2. This is not required in the following cases

- When interconnecting the safe input of the option with an electromechanical sensor, contact bounce may result in signal changes occurring, to which the option could respond.
- Several control modules test their safe outputs using Test Pulse Pattern (on/off tests), to identify faults due to either short or cross circuiting. When interconnecting the safe input of the option with a safe output of a control module, the option could respond to these test signals.

A signal change during a Test Pulse Pattern usually lasts 1 ms.

Under stable signal time, short pulses, which could lead to safety functions being incorrectly activated, can be filtered.

NOTE

The stable signal time extends the MCB 15x response time. The MCB 15x only activates the safety function after the response time has expired.

If the signal to the input on MCB 15x is not stable, the option responds with a fault.

Definition of a stable signal

Following a change to the DI input signals, the option triggers an internal monitoring time. Use 42-23 *Stable Signal Time* to select an appropriate stable signal time. A constant signal level is a high or a low state, for at least 42-23 *Stable Signal Time*.

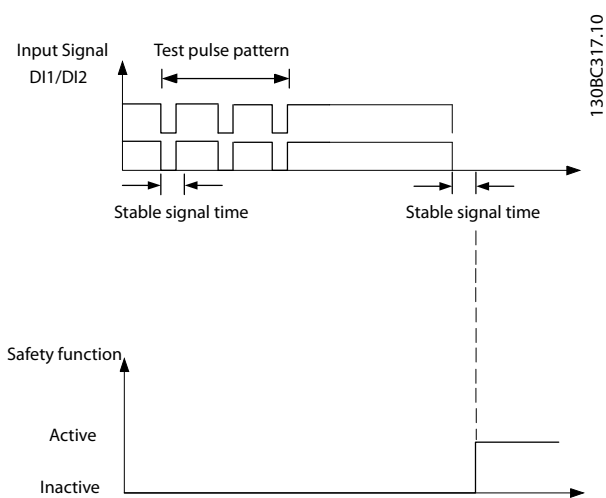

Illustration 2.15 Filter for Suppressing Temporary Signal Changes

2.5.8 Zero Speed Time Error Detection

Zero Speed Timer monitors if the frequency converter is operated below 120 RPM during Safely Limited Speed.

42-18 *Zero Speed Timer* contains the remaining time until the monitoring responds. The MCB 15x signals *Alarm Ext Fail Prec Thresh Timer Elapsed* after the monitoring time expires.

Define the monitoring time while commissioning the system depending on the particular application.

2.5.9 Yearly Test

According to EN ISO 13849-1, EN IEC 62061 and EN IEC 61508, the MCB 15x must regularly test its safety-relevant circuits to ensure correct functioning. This test must be performed at least once every year. After the power supply has been connected, the MCB 15x checks its circuits to switch-off the torque each time the Safe Torque Off function is selected. The MCB 15x monitors the regular test of its safety-relevant circuits using a time module.

After one year in operation, the frequency converter displays a message that a yearly test must be performed. The frequency converter must be power cycled by disconnecting and then reconnecting the supply voltage. Activate the used inputs on the MCB 15x and check that they function correctly.

2.5.10 Safety Parameter Settings

Factory setting for both digital inputs is Safe Torque Off, meaning that the Safe Output S37 is in low state.

At the first power up, the option shows Blank Initial State.

Properties of Safety parameters

- They are kept separate for each monitoring channel.
- During start-up, a checksum (Cyclic Redundancy Check, CRC) over the safety parameters is generated and checked. The parameters are stored on the non-volatile memory on the option.

A reset of the safety parameters to the factory setting can be executed via MCT 10 Set-up Software.

NOTE

If the MCB 15x is reinstalled in another frequency converter, all MCB 15x parameters can be selected either from the MCB 15x or the parameters in the frequency converter in which the option is now installed. A commissioning test must always be performed to ensure the correct functionality.

2.5.11 Encoder Interface

CAUTION

Some of the diagnostics performed on the encoder signals require motion to detect faults. Make sure that motion occurs at least once every 12 months.

To detect the standstill or the motor speed, the speed (frequency) is measured using a TTL encoder (MCB 150), an HTL encoder (MCB 151) or a PNP proximity switch (MCB 151). The HTL encoder uses two signal tracks, A and B. TTL encoders uses two signal tracks A, B and their inverted tracks nA, nB.

Use twisted-pair, individually screened cable to connect encoders and MCB 15x.

2.6 Limitations

2.6.1 Exceeded Limit Value and Internal Errors

- Exceeding set limit values activate the stop braking ramp.
- Any internal error on the MCB 15x or frequency converter activates the safety function Safe Torque Off. The frequency converter coasts the motor.

Internal errors always result in a fault, requiring a power cycle of the frequency converter to reset the failure. Alternatively, use *42-90 Restart Safe Option* to restart the MCB 15x after internal failure without power cycling the frequency converter.

2.6.2 Compatibility between Safety and Frequency Converter Functions

Ensure that MCB 15x is compatible with the used frequency converter functions. *Table 2.15* shows compatible functions.

Frequency Converter Function	SLS	SS1	STO
Power sizes 0.37-75 kW	C	C	C
PROFIBUS DP V1 MCA 101	C	C	C
VVC ^{plus} open loop	C	C	C
VVC ^{plus} closed loop	C	C	C
24 V DC supply option MCB 107	C	C	C
FLUX open loop	X	X	X
FLUX closed loop	X	X	X
Ramp	C	C	C
Load sharing	C	C	C
DC brake	C	C	C
OVC	C	C	C
Flying start	C	C	C
External fault	C	C	C
Jog	C	C	C
U/f	C	C	C
Kinetic back-up	C	C	C
LCP sw version 7.0 and newer is supported	C	C	C

Table 2.15 Compatibility of Safety and Frequency Converter Functions

C: *Compatible functions*

X: *Incompatible functions*

3 Installation

3.1 Installing the MCB 15x

⚠ WARNING

Before start, disconnect the power supply voltage to the frequency converter. Never install an option card into the frequency converter during operation.

Ensure that all dangerous voltages connected from external control circuits to the inputs and outputs of the frequency converter are switched off. In addition to conventional installation tools, have the Operating Instructions for VLT® AutomationDrive and MCT 10 Set-up Software available as they contain important information that is not included in this manual.

The MCB 15x VLT Safe Option is exclusively intended for use in option slot "B". The mounting position of B options is shown in *Illustration 3.1*.

⚠ WARNING

ELECTRICAL HAZARD!

Safe Stop activation (Safe Torque Off) does not provide electrical safety. The safety device connected to the dual pole input of the MCB 15x must fulfill the requirements safety level for the application for interrupting the voltage/current to MCB 15x. This is also valid for the connections between MCB 15x safe output S37 and terminal T37 on the frequency converter. Read and follow the instructions for the safety device to connect it properly to the MCB 15x.

3.1.1 Requirements for Safe Use

⚠ CAUTION

Ensure that the installation and wiring are EMC-compliant to avoid personal injury and damage to the product.

Refer to the guidelines stated in this manual. Also ensure compliance with

- VLT® AutomationDrive Operating Instructions
- Tool-Tip help for the configuration tool MCT 10 Safe Plug-in

The MCB 15x may only be used with the following frequency converters

- VLT® AutomationDrive FC 302, power sizes from 0.37 kW to 75 kW, from SW Version 6.64

3.1.2 Protected Cable Installation

If short circuits and cross circuits can be expected with safety-related signals and if they are not detected by upstream devices, protected cable installation is required as per EN ISO 13849-2.

3.1.3 Installation

⚠ CAUTION

The VLT® AutomationDrive with MCB 15x (including the connection between output S37 (Y30/12 or Y31/12) on MCB15x and X44/12 on the control card) must be placed in an IP54 enclosure as per IEC 60529.

These step-by-step instructions describe how to mount the control cables

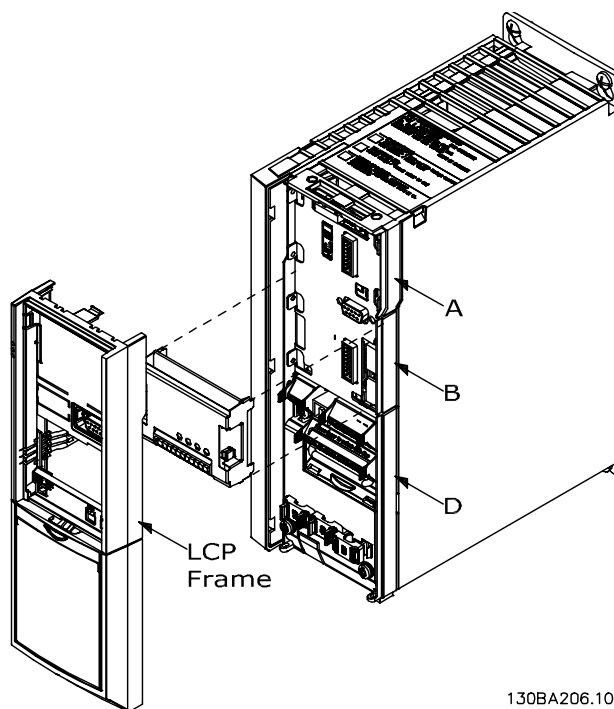

Illustration 3.1 How to Fit the MCB 15x

A	A-option slot
B	B-option slot
D	D-option slot

Table 3.1 Legend to Illustration 3.1

3

1. Disconnect power to the frequency converter.
2. Remove the LCP, the terminal cover, and the LCP frame from the frequency converter.
3. Fit the MCB 15x option in slot B.
4. Remove the jumper wire between control terminals 37 and 12 or 13.
 - Cutting or breaking the jumper is not sufficient to avoid short circuiting.

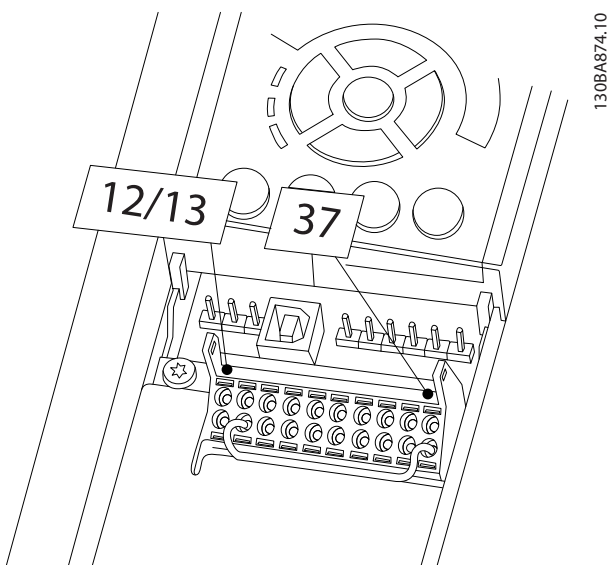

Illustration 3.2 Jumper between Terminal 12/13 (24 V) and 37

5. Connect the safe output S37 on the MCB 15x to terminal 37 on the control card (maximum length of this wire is 10 cm).
 6. Connect the control cables to MCB 15x and relieve the cable by the enclosed cable strips.
- Follow the General Wiring Guidelines in 3.1.4 General Wiring Guidelines.

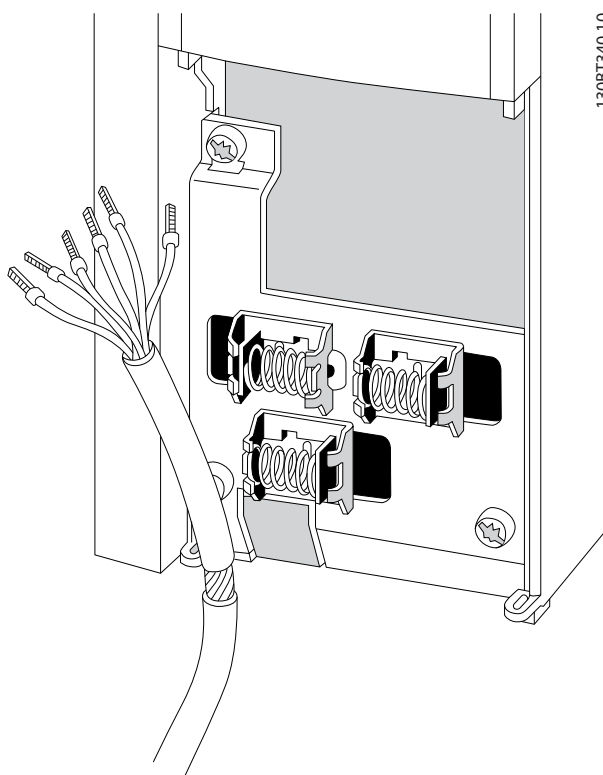

Illustration 3.3 Connecting Screened Wire

7. Remove the knock out in the extended LCP frame, so that the option will fit under the extended LCP frame.
8. Fit the extended LCP frame and terminal cover.

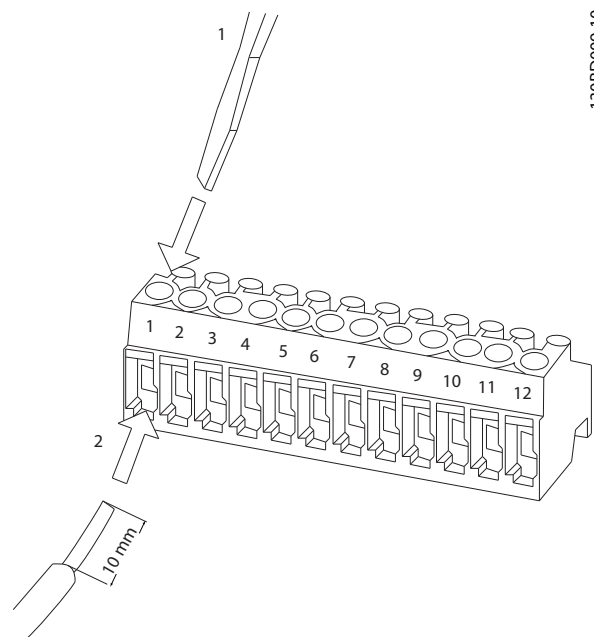

Illustration 3.4 Connecting Control Wiring

NOTE

The connections are not pre-wired from factory.

9. Fit the LCP or blind cover in the extended LCP frame.
10. Connect power to the frequency converter.
11. Set up the input/output functions in the corresponding parameters, as mentioned in the manual for the Safe Plug-in in MCT 10

The commissioning test report is automatically generated via the Safe Plug-in in MCT 10 after downloading the parameters to the MCB 15x.

- Connect cable screens as close as possible to the cabinet cable entry
- If at all possible, intermediate terminals should not interrupt cable screens
- Retain cable screens for both power cables as well as for signal and data cables using the appropriate EMC clamps. The screen clamps must connect the screen to the EMC shield bar or the screen support element for control cables through a low inductive connection through a large surface area.

CAUTION

The operator or electrical installer is responsible for proper earthing and compliance with all applicable national and local safety regulations.

3.1.4 General Wiring Guidelines**Inputs**

Use appropriate wiring to exclude short circuits between the inputs or to a supply line

Output

Use separate multicore cable for supply voltages to avoid short circuits between the cable from the output (S37) to the 24 V DC supply line



As a result of short circuits, it is no longer possible to switch off the frequency converter Terminal 37.

NOTE

Control cables must be screened/armoured.

See 8.9.3 *Earthing of Screened Control Cables* in the VLT[®] *Automation Drive Design Guide* for detailed specifications.

Only screened cables are suitable for connecting encoders.

NOTE

All signals to MCB 15x must be PELV supplied and comply with EN IEC 60204.

- Route sensitive control cables - such as encoder and active safety component cables - without any interruption with optimum screen support at both ends
- Connect screens at both ends to the grounded enclosures through a good electrical connection and through a large surface area

3.1.5 Connector Pin Assignment

Y30	Pin	Name	Description
	1	DI1 A	Digital Input 1 A channel
	2	GND	Digital GND
	3	DI1 B	Digital Input 1 B channel
	4	ENC A	Encoder Channel A
	5	DI2 A	Digital Input 2 A channel
	6	ENC nA	Encoder Channel A inverted
	7	ENC B	Encoder Channel B
	8	DI2 B	Digital Input 2 B channel
	9	ENC nB	Encoder Channel B inverted
	10	24 V	Power output
	11	GND	Supply GND
	12	S37	STO enable

Table 3.2 Connector Pin Assignment, MCB 150

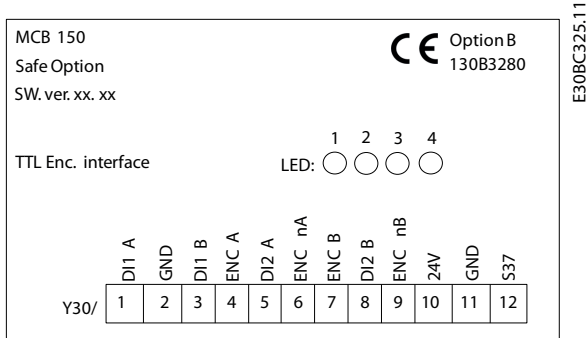

Illustration 3.5 Nameplate MCB 150

Y31	Pin	Name	Description
	1	DI1 A	Digital Input 1 A channel
	2	GND	Digital GND
	3	DI1 B	Digital Input 1 B channel
	4	ENC A	Encoder Channel A
	5	DI2 A	Digital Input 2 A channel
	6	GND	Digital GND
	7	ENC B	Encoder Channel B
	8	DI2 B	Digital Input 2 B channel
	9	GND	Digital GND
	10	24 V	Power output
	11	GND	Supply GND
	12	S37	STO enable

Table 3.3 Connector Pin Assignment, MCB 151

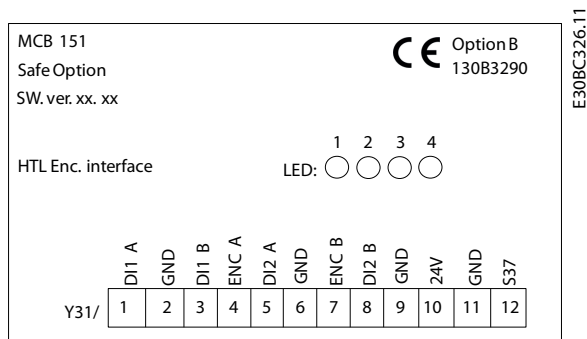

Illustration 3.6 Nameplate MCB 151

3.2 Encoder

3.2.1 Permissible Encoder Cable Length

The permissible cable length depends on the selected encoder. The longest cable can be achieved when using bipolar TTL encoders.

Unipolar HTL encoders only permit a shorter length. In this case, the encoder power supply voltage plays a decisive role.

The maximum cable length for HTL encoders used as unipolar encoder (in this case only one signal is evaluated) is 100 m.

The maximum cable length for TTL encoders used as bipolar encoder (in this case both signals A/nA or B/nB) is 150 m.

The minimum cross section of the power supply conductor is 0.75 mm².

NOTE

Routing of the sensor cables

All initiator/encoder cables must be screened when laid. The screen must be connected to chassis at both ends. Always connect chassis on the rotary encoder to chassis on the frequency converter.

CAUTION

The sensor connections must not be plugged in or pulled off during operation. This could damage the electrical components of the encoder. Always de-energise connected encoders and the MCB 15x before plugging in or pulling off encoder connections. Lines twisted in pairs for signal transmission according to RS-485 standard must be used for data signals or track A and track B. The wire cross section must in each individual case be chosen in compliance with the current consumption of the encoder and the cable length required for the installation.

Diagnostics are performed on the encoder input signals. If the encoder diagnostic tests fail, an error 99 (Safe State fault) occurs.

3.2.2 Encoder Wiring Examples

Illustration 3.7 and Illustration 3.8 show examples of how to connect encoder power and encoder signals.

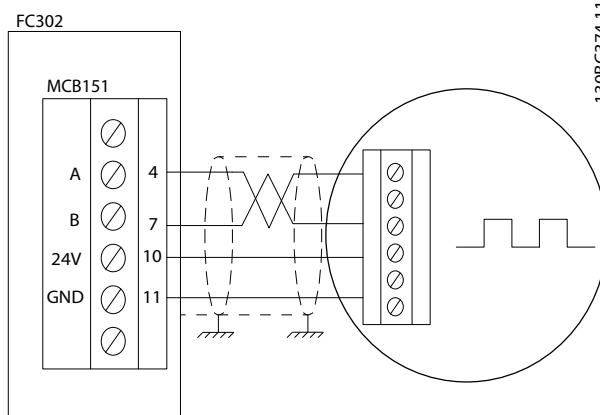

Illustration 3.7 Y31/ Connecting Power and Encoder Signals to HTL Encoder (MCB 151)

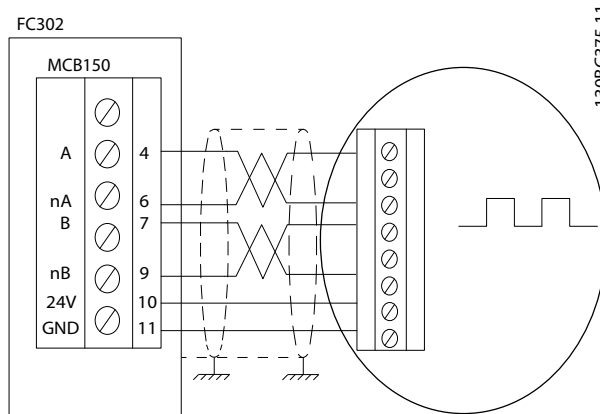

Illustration 3.8 Y30/ Connecting Power and Differential Encoder Signals to TTL Encoder (MCB 150)

Illustration 3.8 shows TTL encoder with 24 V supply and TTL output. If an encoder for 5 V supply must be connected, use a 5 V external supply.

3.2.3 Proximity Switch

An inductive proximity switch, detecting already present mechanical parts, e.g. a gear wheel, is a frequently used alternative to standard encoders. The minimum number of teeth on the gear wheel is 2.

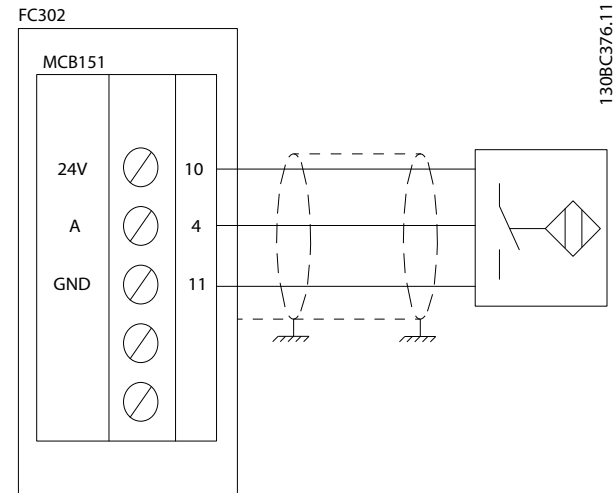

Illustration 3.9 Y/31 Connecting Power to Proximity Switch (only HTL)

NOTE

The proximity switch cable must be screened and terminated to chassis at both ends (at the proximity switch side and at the option side).

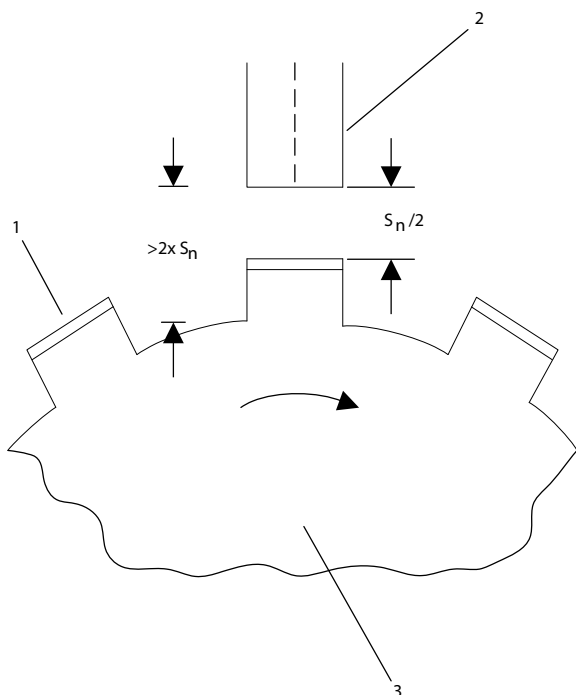

Illustration 3.10 Gear Wheel for Proximity Switch

1	Measuring plate
2	Proximity switch
3	Disc (non conducting material)

Table 3.4 Legend to Illustration 3.10

The operating distance S set to half the nominal operating distance S_n , corresponds approximately to the optimum conditions with respect to resolution and switching frequency.

NOTE

When using PNP proximity switch as encoder feedback, set 42-14 Feedback Type to [1] Without direction info.

3.3 Application Examples

3.3.1 Connecting Safe Digital Inputs

The following pages contain examples of connecting the fail-safe digital input according to EN ISO 13849-1 and EN IEC 62061. The examples apply in cases where all components are installed in a control cabinet.

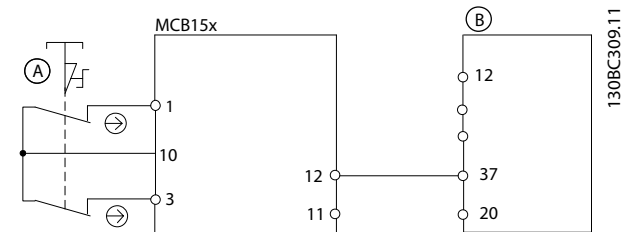

Illustration 3.11 Connecting a Sensor, e.g. 2-channel Emergency Stop Mushroom Push Button or Limit Switch

A	2-channel emergency stop switch
B	FC 302

Table 3.5 Legend to Illustration 3.11

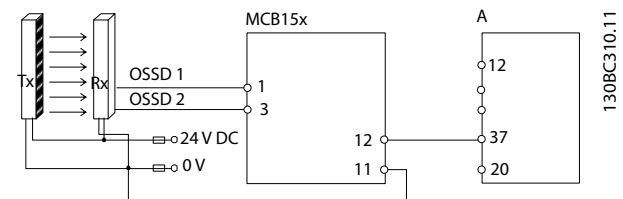

Illustration 3.12 Connecting an Electronic Sensor, e.g. Safety Light Curtain

A	FC 302
---	--------

Table 3.6 Legend to Illustration 3.12

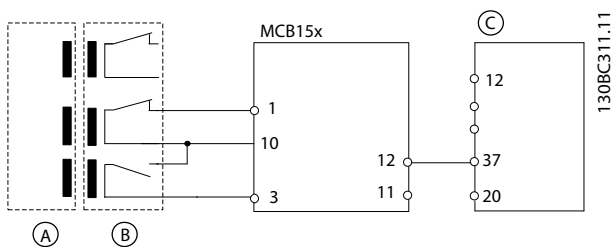

Illustration 3.13 Connecting 1 NO/1 NC Sensor, e.g. Magnetic Switch

A	Actuator
B	Switch
C	FC 302

Table 3.7 Legend to Illustration 3.13

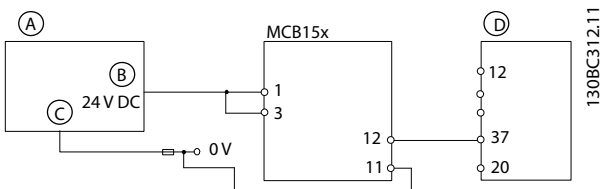

Illustration 3.14 Connecting a Digital Output Module, e.g. Safety PLC

A	Safety PLC
B	Safety output
C	GND
D	FC 302

Table 3.8 Legend to Illustration 3.14

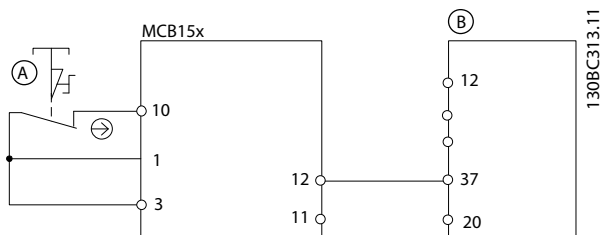

Illustration 3.15 Connecting a Sensor, e.g. 1-channel Emergency Stop Mushroom Pushbutton or Limit Switch

A	1-channel emergency stop switch
B	FC 302

Table 3.9 Legend to Illustration 3.15

NOTE

All equipment used must be suitable for the selected category/PL or SIL.

NOTE

Use of a 1-channel E-stop switch provides no input redundancy, and no ability for the MCB 15x to monitor for input short circuits. One-channel E-stop switches used with an MCB 15x are suitable only for Category 2 applications, per EN ISO 13849-1 PL c or SIL1.

When a 1-channel E-stop is used, guard against failure modes that can result in an unsafe condition. An example of an unsafe condition could be the failure of the contact to a short circuit condition. A switch with positive opening operation should be used to reduce the possibility of a failure of the switch to open. A short circuit failure results in loss of switching function. This failure can occur from a short across the switch contacts, a short across the wires connected to the switch between the switch and the MCB 15x, or a short to a secondary source of power. To reduce these risks, physically separate the wires from each other and from other sources of power (e.g., in separate wire ways or conduit). According to the definition of European standard EN ISO 13849-1, a 1-channel E-stop could be used in applications where PL c or less (b or a) has been determined via a risk-assessment procedure.

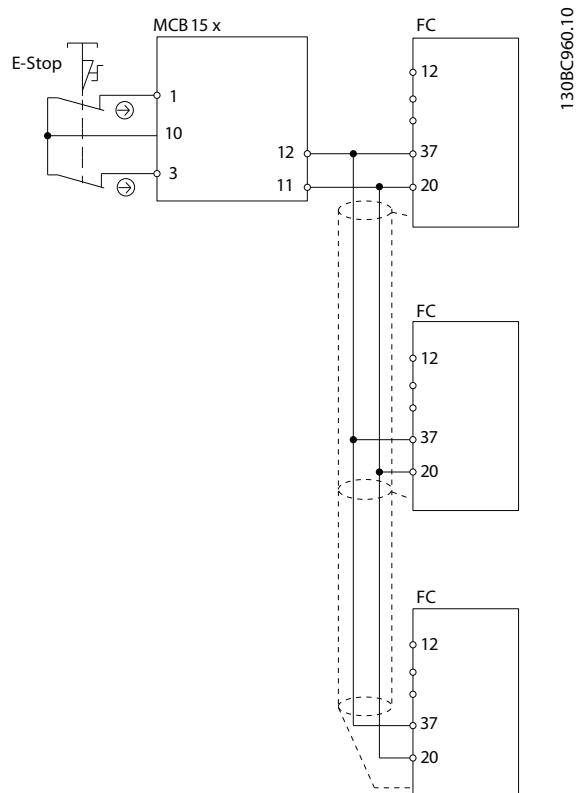

Illustration 3.16 Example of Multiple Frequency Converters in Daisy Chain

Up to 3 frequency converters may be connected in a daisy chain. Total cable length must not exceed 30 m.

4 Commissioning

4.1.1 Safety Guidelines

When commissioning/recommissioning

- Secure the site in accordance with regulations (barrier, warnings, signs, etc.). Only qualified personnel is allowed to commission/recommission the system
- Refer to the guidelines, information and specifications stated in the Operating Instructions of the relevant programmable control system
- Make sure that no personal injury and/or material damage can occur, even if the plant/machine moves unintentionally

CAUTION

ELECTROSTATIC DISCHARGE!

Electrostatic discharge can damage components. Ensure discharge before touching the MCB 15x, e.g. by touching an earthed, conductive surface or by wearing an earthed armband.

⚠WARNING

RISK OF ELECTROCUTION!

Never wire the electrical connections on the frequency converter while voltage is applied.

Switch off power.

Make sure that the control cabinet is provided with access lock or warning signs.

DO NOT switch on the voltages until the system is commissioned.

Refer to *VLT® AutomationDrive Operating Instructions* for further information on the frequency converter.

Refer to *MCT 10 Set-up Software Operating Instructions* for further information on the Safe Plug-in.

4.1.2 Commissioning Requirements

The procedure requires installation of MCT 10 Set-up Software, version 3.18 or later, and a successful connection to VLT® AutomationDrive with integrated MCB 15x.

1. Configure the MCB 15x in the MCT 10 with Safe Plug-in. Ensure only to configure safety functions that are wired up to the MCB 15x inputs.
2. Ensure that the device number (serial number and order number) of the MCB 15x on the frequency converter matches the device number of the MCB 15x in the MCT 10 Safe Plug-in.

3. Ensure that the frequency converter is ready for commissioning (see *VLT® AutomationDrive Operating Instructions*)

The following components are required to perform the necessary steps for commissioning the MCB 15x.

- MCT 10 Set-up Software
- Profibus MCA 101 DP V1 connection or RS-485 Interface adaptor for connecting the control card of the frequency converter with the PC

Observe the following

- When setting up the option for the first time, ensure to have a commissioning report at hand, see further information in *MCT 10 Set-up Software Operating Instructions*

NOTE

Only LCP SW version 7.0 or newer is supported.

4.2 Initial Commissioning

4.2.1 Power-up/Self-test

Once the power supply has been applied to the frequency converter, the MCB 15x performs a self-test. During the self-test phase, all LEDs light up (lamp test) and the message *Safe Opt. initialized - SO RESET requested* or *SO in Self-test* appears. After power-up, the LEDs light up according to the device status.

NOTE

If the supply voltage of the MCB 15x exceeds the permissible range, the safety function *Safe Torque Off* is triggered. The safety-related output is switched off.

4.2.2 Initial Commissioning

1. Connect the configuration PC to the frequency converter or motion control system
 - 1a Make the interface in the MCT 10 Safe Plug-in (refer to the chapter *Functional Safety Configuration Plug-in* in the *MCT 10 Set-up Software Operating Instructions* and the Tool-Tip for help).
2. Switch on the supply voltages
 - Switch on all the supply voltages for the frequency converter and MCB 15x
 - The display elements on the frequency converter and on the MCB 15x show when they are ready for operation. The display elements on the MCB 15x are described in *4.2 Operation*.
3. Download configuration file
 - Establish communication between the PC and the frequency converter by selecting *Write to drive* in the MCT 10 Safe Plug-in
 - Make sure that no other system is accessing the interface
 - Apply password, unequal to default password
 - On multi-axis systems the MCB 15x can be selected individually for the download. The configuration is distributed to the MCB 15x options via the MCT 10.

When the configuration file is downloaded, the LCP reads "SO Custom. completed".

The configuration is checked as it is downloaded.

- Feasibility of the configuration data
- Proper wiring
- Correct device number (order number). If the self test is successful, the frequency converter's power element is enabled.

NOTE

Up to 10 seconds may elapse before the MCB 15x is ready for operation.

4.2.3 Safe Option Customisation

LCP messages used to indicate the different states of the customisation processes.

LCP message	Description
	MCT 10 Customisation of MCB 15x requested
	MCT 10 Customisation of MCB 15x aborted
	MCT 10 Customisation of MCB 15x complete

Table 4.1

4.2.4 Setting up the Encoder

1. Choose the type of feedback device, either [1] *Safe Option* or [0] *None* in *42-10 Measured Speed Source*. For SS1 time delay functionality no feedback source is necessary.
2. Set the feedback parameters for the MCB 15x.
 - In Closed Loop applications set *7-00 Speed PID Feedback Source* to [11] *MCB 15x*
3. Set *Mounting Type* to *Motor shaft mounted* or *Application mounted*.
 - Select a gear ratio within 0.0001 - 32.0000 (default 1) in *42-13 Gear Ratio*.
4. Set the correct encoder value in *42-11 Encoder Resolution*.
5. Set *42-12 Encoder Direction* to [0] *Clockwise* (default) or [1] *Counter clockwise*.
6. Set *42-14 Feedback Type* to [0] *With direction info* or [1] *Without direction info*.

NOTE

If the selected encoder resolution is below 150 PPR for HTL/TTL encoder, set a feedback filter value in *42-15 Feedback Filter*. The system then calculates an allowed value. This is also the case when using a proximity switch feedback where the encoder resolution is below 600 PPR.

NOTE

Depending on the system, a movement can imply different directions for the motor encoder.

NOTE

Depending on the application, the motor encoder may be connected via a gearbox.

4.2.5 Commissioning Test

The MCT 10 Safe Plug-in creates a commissioning report based on the commissioning test result. It generates the frequency converter safety signature. This function provides a final report when the MCB 15x has been configured. This report is considered as a help tool for safety commissioning and validates that all the safety functions are operational. The commissioning report can either be printed or converted into a PDF file.

The test objective is to verify proper implementation (forced dormant error detection measures) and to examine the response of specific monitoring functions to the explicit input of values outside tolerance limits.

⚠ WARNING

After hardware and/or software components have been modified or replaced, all protective equipment must be closed before system start-up and activation of the frequency converter. Personnel must keep out of the danger zone. It is mandatory to carry out a partial or complete commissioning test after having made certain changes or replacements. Before allowing anybody to re-enter the danger zone, test the steady control response by briefly moving the frequency converters in forward and reverse direction (\pm).

EN IEC 61508, EN IEC 62061 and EN ISO 13849 require that the final assembler of the machine validates the operation of the safety function with a commissioning test. The commissioning tests for the standard safety functions Safe Stop of the frequency converter are described in the frequency converter manuals. The tests for the optional safety functions are described in the commissioning report generated by the MCT 10 Safe Plug-in. The commissioning test must be performed

- at initial start-up of the safety function
- after any changes related to the safety function (wiring, components, settings, etc.)
- after any maintenance work related to the safety function.

The test objective is to verify proper implementation (forced dormant error detection measures) and to examine the response of specific monitoring functions to the explicit input of values outside tolerance limits.

4.3 Operation**⚠ WARNING****UNINTENDED BEHAVIOUR**

Numerous stored data or settings govern the behaviour of the frequency converter system. Unsuitable settings or data may trigger unexpected movements or responses to signals and disable monitoring functions.

- Do NOT operate the frequency converter system with unknown settings or data
- Verify that the stored data and settings are correct
- When commissioning, carefully run tests for all operating states and potential error situations
- Verify the functions after replacing the product and also after changing the settings or data
- Only start the system if there are no persons or obstructions in the hazardous area

Failure to follow these instructions can result in death, serious injury or equipment damage.

Prerequisites for normal operation are

- commissioning is complete
- the MCB 15x contains the configuration data
- the safety functions have been tested
- LED1, LED2 and LED4 are lit

During operation

- any pulse edge change at the MCB 15x safe input is monitored
- the safety functions are performed in accordance with the configuration

5 General Parameter Set-up

5.1 Configuration

5.1.1 General Parameter Set-up

See *5.2 Parameter List* to configure an operation of the MCB 15x. The set-up is done via MCT 10 Safe Plug-in.

Speed monitoring by MCB 15x

If an external encoder is connected to the MCB 15x and selected in *42-10 Measured Speed Source*, speed monitoring is active all the time whether a safety function is requested or not. However, if a Safe Torque Off is triggered (either directly, or as a consequence of a Safe Stop 1) it interrupts the speed monitoring.

Encoder Configuration

To define the type of feedback used by the MCB 15x, select *[1] Safe option* in *42-10 Measured Speed Source*.

5.1.2 Parameter Status via Fieldbus

Via the Profibus fieldbus, if installed, read access to the status parameters of the safety module MCB 15x is possible. The parameters are accessed the same way as the parameters of the frequency converter. The states of the inputs and the output as well as the operating states of the MCB 15x can be read via the fieldbus. For further information, refer to the *VLT® AutomationDrive Programming Guide*.

- STO active
- SS1a active
- SS1b active
- SLSa active
- SLSb active
- DI1 active
- DI2 active
- Error active

5.1.3 Configuration

The safety functions to be carried out by the MCB 15x are defined in the MCT 10 Safe Plug-in.

- Configurations of the safety functions
- Setting of limit values, braking ramps for the safety functions, monitoring of motion sequences

NOTE

Always perform the required commissioning test. The commissioning test report is automatically generated via the Safe Plug-in in MCT 10 after downloading the parameters to the MCB 15x.

Download of the configuration to MCB 15x.

- On single-drive systems, via the RS-485/USB interface on the frequency converter
- On networked systems, via the RS-485 or Profibus MCA 101 DP V1 interface on the MCT 10 Safe Plug-in. The control system passes the configuration to the respective MCB 15x
- The feasibility of the configuration is checked when it is downloaded

Further information on configuration and setting parameters for the safety functions is available in the online help for the MCT 10 Safe Plug-in and in the *MCT 10 Set-up Software Operating Instructions*.

The MCB 15x is configured with the commissioning software MCT 10 Set-up Software via a Safe Plug-in. The Safe Plug-in in the commissioning software is available as default from version 3.18.

The commissioning software provides the following menu items for the MCB 15x

- General Speed Monitoring
- Safe Input
- Safe Stop 1
- Safely Limited Speed
- Parameters
- Status

The menu items are described in detail in the *MCT 10 Set-up Software Operating Instruction*.

The menu item *Status* shows the following

- Current signal states of inputs and output
- Option operating mode
- Active safety function

The states of the inputs and output cannot be changed via the commissioning software.

5.1.4 Password Protection

Use a password to protect the system configuration. A password must be entered only when changing safe option parameters (writing to option).

Default password is 12345678.

Change the MCB 15x default password before downloading the parameter values of an MCB 15x with factory settings. Only persons knowing the parameter password can change the MCB 15x parameter values.

NOTE

No password is required to access the commissioning parameters of the MCB 15x. The password is required when the parameters must be downloaded to the option via *Write to Drive*.

The password **must** be of 8 characters and is case-sensitive. Alphanumeric characters and symbols are valid for password.

The MCB 15x checks the parameter password entered. Use the menu item *Change Password* to change the MCB 15x parameter password. Change the MCB 15x password if there is any indication of manipulation.

Forgot the MCB 15x parameter password?

- Select [Reset] in [Administration]
- Change the MCB 15x password
- Perform a commissioning test

5.2 Parameter List

All parameters except 42-90 *Restart Safe Option* are read only.

Group	Group Name	Parameter	Value range/ available choices	Default	Description	Conversion index	Data type
42-1*	Speed Monitoring	42-10 Measured Speed Source	[0] None [1] Safe Option	[1] Safe Option	The source of the speed feedback.	-	u_int8
		42-11 Encoder Resolution	1 - 4096 ppr (for HTL encoder) 1 - 10000 ppr (for TTL encoder)	1024 ppr	Encoder or Proximity Switch resolution of the encoder connected to the MCB150 HTL and MCB151 TTL.	0	u_int16
		42-12 Encoder Direction	[0] Clockwise [1] Counter clockwise	[0] Clockwise	Gives the possibility to change the detected encoder rotation direction without changing the wiring to the encoder.	-	u_int8
		42-13 Gear Ratio	0.0001 - 32.0000	1	Ratio between motor speed and encoder speed. Remark: Only used when gear mounted.	-4	u_int32
		42-14 Feedback Type	[0] With direction info [1] Without direction info	[0] With direction info	The feedback can be with or without direction information. For Encoder direction info is available. For Proximity Switch, select [1] Without Direction Info.	-	u_int8
		42-15 Feedback Filter	0.01 - 200.00 Hz	200 Hz	Frequency of the feedback filter. Default value is 200 Hz (off) if the encoder resolution is higher than 150 ppr. A filter value of 200 Hz is selected, meaning the filter is off. Based on the given encoder resolution, gear ratio and feedback type, it will be recommend whether to use the filter or not.	-2	u_int16
		42-18 Zero Speed Timer	0 - 10000 h	8760 h	Time period where the option is allowed to be below 120 RPM when SLS is active before STO is activated.	74	u_int16
		42-19 Zero Speed Limit	Fixed	120 RPM		67	u_int16

Group	Group Name	Parameter	Value range/ available choices	Default	Description	Conversion index	Data type
42-2*	Safe Input	42-20 Safe Function	[0] STO [1] SS1-a [2] SS1-b [3] SLS-a [4] SLS-b [5] disable	[0] STO	This can be one of the safety functions or disabled. Remark: Both Safe Inputs can NOT be disabled at the same time!	-	u_int8
		42-21 Type	[0] NCNC [1] Antivalent [2] NC	[0] NCNC	NCNC, antivalent (NC/NO) or 1NC.	-	u_int8
		42-22 Discrepancy Time	0 - 5000 ms	10 ms	An adjustable filter time prevents faults caused by temporary discrepancy.	-3	u_int16
		42-23 Stable Signal Time	0 - 5000 ms	10 ms	An adjustable signal filter in the MCB 15x suppresses temporary signal changes using Test Pulse Pattern.	-3	u_int16
		42-24 Restart Behaviour	[0] Manual [1] Automatic	[0] Manual	In case of an activated safety function, the MCB 15x can restart automatically or wait for a RESET signal from the user.	-	u_int8
42-3*	General	42-30 External Failure Reaction	[0] STO [1] SS1-a [2] SS1-b	[0] STO	Safety Function that will be executed in case of an external failure.	-	u_int8
		42-31 Reset Source	[0] Drive Reset [1] Drive Safe Reset [2] Safe Option DI2_A	[0] Drive Reset	Source for the RESET of the MCB 15x. Can either be executed on the option input DI2, via profibus or and digital input on the FC or via the LCP. By selecting <i>Drive Safe Reset</i> only the MCB 15x is reset.	-	u_int8
		42-33 Parameter Set Name	Visible String, length: 8	SafeSet1	Name of the Safe Parameter Set (must be 8 characters to avoid a Bad Customization data Error).		

Group	Group Name	Parameter	Value range/ available choices	Default	Description	Conversion index	Data type
42-4*	SS1	42-40 Type	[0] Delay [1] Ramp (slope) [2] Ramp (time)	[0] Delay	The type of the SS1 Safety Function.	-	u_int8
		42-41 Ramp Profile	[0] Linear [2] S-ramp Const Time	[0] Safe Option Linear	The ramp profile for a SS1 Delay can be either specified as linear or S-ramp.	-	u_int8
		42-42 Delay Time	0.1 - 3600.0 s	1.0 s	Time until STO is activated	-1	u_int16
		42-43 Delta T	0 - 99 %	2%	ΔT will be subtracting from the time in <i>42-42 Delay Time</i> to get motor to stop before the timer expires.	0	u_int8
		42-44 Deceleration Rate	1 - 30000 RPM/s	1500 RPM/s	Deceleration rate for the SS1 slope based ramp type.	0	u_int16
		42-45 Delta V	1 - 10000 RPM	120 RPM	Tolerance between calculated and actual speed that the MCB 15x allows.	67	u_int16
		42-46 Zero Speed	1 - 600 RPM	10 RPM	When this speed is reached, the MCB 15x activates the STO.	67	u_int16
		42-47 Ramp Time	0.1 - 3600.0 s	1.0 s	Time to ramp down to 0 RPM	-1	u_int16
		42-48 S-ramp Ratio at Decel. Start	1 to (100 - 42-49 S-ramp Ratio at Decel. End) %	50%	The proportion of the total ramp-down time (<i>42-42 Delay Time</i>) where the deceleration torque increases. The larger the percentage value, the greater the jerk compensation achieved, and thus the lower the torque jerks in the application.	0	u_int8
	42-49 S-ramp Ratio at Decel. End	1 to (100 - 42-48) %	50%	The proportion of the total ramp-down time (<i>42-42 Delay Time</i>) where the deceleration torque decreases. The larger the percentage value, the greater the jerk compensation achieved, and thus the lower the torque jerks in the application.	0	u_int8	

Group	Group Name	Parameter	Value range/ available choices	Default	Description	Conversion index	Data type
42-5*	SLS	42-50 Cut Off Speed	(42-51 + 1) to 10000 RPM	270 RPM	Speed at which the Fail Safe Reaction gets activated. This should be the value of 42-51 Speed Limit plus a tolerance.	67	u_int16
		42-51 Speed Limit	0 to (42-50 - 1) RPM	150 RPM	Maximum speed that is allowed when the SLS function is active.	67	u_int16
		42-52 Fail Safe Reaction	[0] STO [1] SS1-a [2] SS1-b	[0] STO	Safety function that will get activated, if the speed exceeds the limit. Only for SLS.	-	u_int8
		42-53 Start Ramp	[0] No [1] Yes	[0] No	If the speed at activation of SLS is higher than the speed limit, it will ramp down to the speed limit (yes) or activate an STO (no).	-	u_int8
		42-54 Ramp Down Time	0.1 - 3600.0 s	1.0 s	Ramp down time for start ramp.	-1	u_int16
42-8*	Status	42-80 Safe Option Status	0 - 4294967295 N/A	0 N/A	Shows the safety option status word as a hexadecimal value.	0	u_int32
		42-81 Safe Option Status 2	0 - 2147483647 N/A	0 N/A	Shows the safety option status 2 as a hexadecimal value. e.g. it contains DI1, DI2 and Blank Initial State status.	0	u_int32
		42-85 Active Safe Func.	<ul style="list-style-type: none"> • [0] STO • [1] SS1-a • [2] SS1-b • [3] SLS-a • [4] SLS-b 	None	Shows the currently active safe function. Can be used on LCP. NOTE Can only be selected in parameters 0-20 to 0-22.	-	u_int8
		42-86 Safe Option Info	0 - None, if no safe function is active	0 N/A	Shows information about Safe Option. Can be used on LCP. NOTE Can only be selected in parameters 0-23 and 0-24.	0	
		42-89 Customization File Version	0.00 - 99.99 N/A	1.00 N/A	Stores the Customization File Version.	-2	u_int16

Group	Group Name	Parameter	Value range/ available choices	Default	Description	Conversion index	Data type
42-9*	Special	42-90 Restart Safe Option	[0] No [1] Yes	[0] No	Possibility to restart option after internal failure without power cycling the frequency converter.	-	u_int8

Table 5.1 Safety Option Parameters

Refer to *VLT® AutomationDrive Operating Instructions* for a comprehensive parameter list.

6 Service and Repair

6.1 Updates, Servicing and Modifications

NOTE

Updates to Firmware

Contact Danfoss to get an update of the firmware.

CAUTION

Firmware Modifications

Only Danfoss is authorized to change the firmware. If other parties make changes to the firmware, the warranty expires. Furthermore, Danfoss cannot be held liable for any consequences the changes may have on the functional safety.

CAUTION

Modifications to the Unit

Only Danfoss is allowed to make hardware modifications of the MCB 15x. If other parties make changes to the unit, the warranty expires. Furthermore, Danfoss cannot be held liable for any consequences the changes may have on the functional safety.

CAUTION

Servicing

Once a year, check that the MCB 15x functions properly to ensure the safety of the option. Perform the check by either

- testing the function, or
- switching off the options used in the safety chain

6.2 Repair

WARNING

ELECTRICAL SHOCK HAZARD!

Always disconnect mains supply to the frequency converter before removing the MCB 15x.

Only Danfoss is authorized to make repair to the MCB 15x. A defect option must be shipped back to Danfoss.

6.3 Replacing

6.3.1 Removing the MCB 15x

Before removing the MCB 15x

1. Save all parameters of MCB 15x, see *MCT 10 Set-up Software Operating Instructions*.
2. Duplicate the existing device setting.

NOTE

The frequency converter generates an error message after removing the MCB 15x.

How to remove the MCB 15x

1. Disconnect all power (power stage supply voltage and controller supply) before plugging in or removing the option.
2. Verify that no voltage is present.
3. Remove the MCB 15x according to the instructions in *Installation in VLT® AutomationDrive Operating Instructions*.

NOTE

If the removed safety module is installed in another frequency converter, the frequency converter issues a warning and SO Parameter Selection. The user can then select the safety configuration from either the frequency converter or from the Safety Option.

6.3.2 Replacing the MCB 15x

WARNING

ELECTRICAL SHOCK HAZARD!

Always disconnect mains supply to the frequency converter before removing the MCB 15x.

When replacing the MCB 15x, note the following

- If the firmware version has changed, configured functions and stated parameters may no longer be supported or may have been modified. Adapt the configuration in the MCT 10 Set-up Software.
- Download the configuration to the MCB 15x again

Alternatively, copy the safe parameters using a graphical LCP, see *6.3.3 Copying Safe Parameter Set-up*.

NOTE

Option Change (Alarm 67) detection informs that a change of the frequency converter hardware configuration has occurred after a power-up. This situation could occur after installing/removing an option, or if an option is defect. If the configuration changes, the frequency converter freezes the hardware configuration, trips and refuses to start up, thus avoiding any unintended parameter changes.

Reset all option parameters to factory settings to avoid this trip.

1. Order a new MCB 15x option at Danfoss.
2. Replace the defective option, see 3 *Installation*.

At the first power-up, the frequency converter recognises different configurations between the MCB 15x and the frequency converter if the safe option parameters are not set to default.

3. Select *Frequency converter*.
4. If configures, enter the password for the copied SO configuration from LCP.
5. Accept to download the safe parameters to the frequency converter/MCB 15x.
6. Select *OK*.
7. Restart the frequency converter.

After replacing the MCB 15x, download the configuration data again, either from

- MCT 10 Safe Plug-in to the MCB 15x via RS-485 or USB
- an LCP in the frequency converter to the MCB 15x

A checksum is saved along with the file to allow for identification for the duplicated MCB 15x parameters. Follow the guided sequence on the LCP display to transfer the MCB 15x parameters to an MCB 15x.

Verify that the correct MCB 15x parameter file is transferred to the MCB 15x.

Perform a commissioning test, see 4.2.5 *Commissioning Test*.

6.3.3 Copying Safe Parameter Set-up

To copy the safe parameter set-up to another frequency converter

1. Prepare a commissioning report.
2. Select [1] *All to LCP* in 0-50 *LCP Copy*. Monitor the upload on the progress bar.
3. Install the LCP with all the copied parameters on the frequency converter that needs to be updated.
4. Select [2] *All from LCP* in 0-50 *LCP Copy*. The normal password protection can be applied in 0-60 *Main Menu Password*.
5. Enter the password for copied SO configuration (= safe parameters) from LCP.
6. Accept the download of the safe parameters to the frequency converter, which now has a new configuration assigned to it.
7. Reset the frequency converter to activate the new configuration.

LCP Copy

Message	Description
<p>0 RPM None 1(1) Password 0-69 Password Protection of safety Parameter [1] Enabled ([0] Disabled)</p>	<p>130BD114.10 The password protection of the safety parameters is enabled.</p>
<p>0 RPM None 1(1) Copy/Save 0-5 x 0-50 LCP Copy [9] Safety Par. from LCP</p>	<p>130BD116.10 Copying the safety parameters from the LCP into the frequency converter is selected.</p>

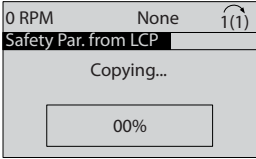
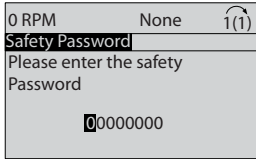
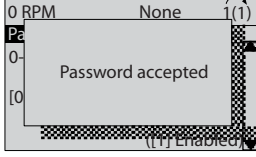
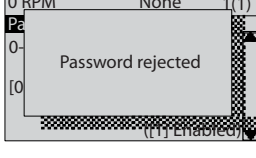
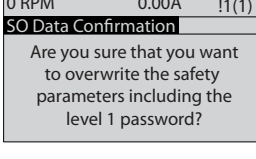
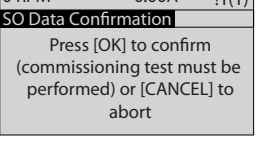
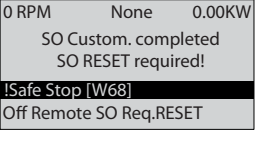
Message	Description
 <p>0 RPM None 1(1) Safety Par. from LCP Copying... 00%</p>	130BD117.10 The safety parameters get copied from the LCP into the frequency converter.
 <p>0 RPM None 1(1) Safety Password Please enter the safety Password 0000000</p>	130BD118.10 Enter the correct safety parameters password (default: 300).
 <p>0 RPM None 1(1) Pe 0- [0 Password accepted (1) Enabled</p>	130BD119.10 If the entered password is correct, this overlay message will be shown for some seconds.
 <p>0 RPM None 1(1) Pe 0- [0 Password rejected (1) Enabled</p>	130BD123.10 If the entered password is wrong, this overlay message will be shown for some seconds. Then the password can be entered again.
 <p>0 RPM 0.00A 1(1) SO Data Confirmation Are you sure that you want to overwrite the safety parameters including the level 1 password?</p>	130BD120.10 Decision box for continuing overwriting the existing data or to abort the procedure.
 <p>0 RPM 0.00A 1(1) SO Data Confirmation Press [OK] to confirm (commissioning test must be performed) or [CANCEL] to abort</p>	130BD121.10
 <p>Status 1(1) 0 RPM None 0.00KW SO Custom. completed SO RESET required! !Safe Stop [W68] Off Remote SO Req.RESET</p>	130BD122.10 Press [OK] to complete the customisation of the safety option. A reset is required to finalize this procedure.

Message	Description
	<p>1308D124.10 Press [Cancel] to abort the customisation of the safety option. A reset is required to finalize this procedure.</p>

Table 6.1 LCP Copy Messages

Mismatch of Safe Option Parameters

Message	Description
	<p>1308D115.10 Whenever there is mismatch of safety parameters within safe option and the frequency converter, this selection form is displayed on the LCP. Select between the 'safety data on safe option' or the 'safety data on frequency converter' as valid data.</p>
	<p>1308D122.10 If selecting [SO:...], the customization of the safety option is completed and a reset is required to finalize this procedure.</p>
	<p>1308D118.10 If selecting [VLT:...], the safety parameters password protection is enabled, enter the correct safety parameters password (default: 300).</p>
	<p>1308D119.10 If the entered password is correct, this overlay message will be shown for some seconds.</p>
	<p>1308D123.10 If the entered password is wrong, this overlay message will be shown for some seconds. Then the password can be entered again.</p>

6

Message	Description
 <p>130BD120.10</p>  <p>130BD121.10</p>	<p>Decision box for continuing overwriting the existing data or to abort the procedure.</p>
 <p>130BD122.10</p>	<p>Press [OK] to complete the customization of the safety option. A reset is required to finalize this procedure.</p>
 <p>130BD124.10</p>	<p>Press [Cancel] to abort the customization of the safety option. A reset is required to finalize this procedure.</p>

Table 6.2 Mismatch between Safety Parameters in the safety Option and the Frequency Converter



1308C327:10

Illustration 6.1 Possible Parameter Set-up

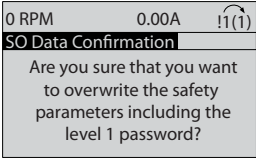
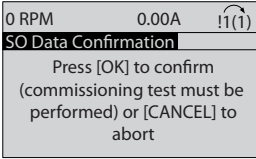
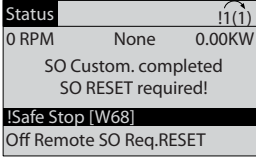
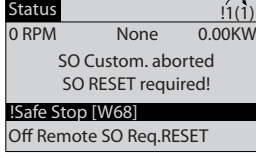
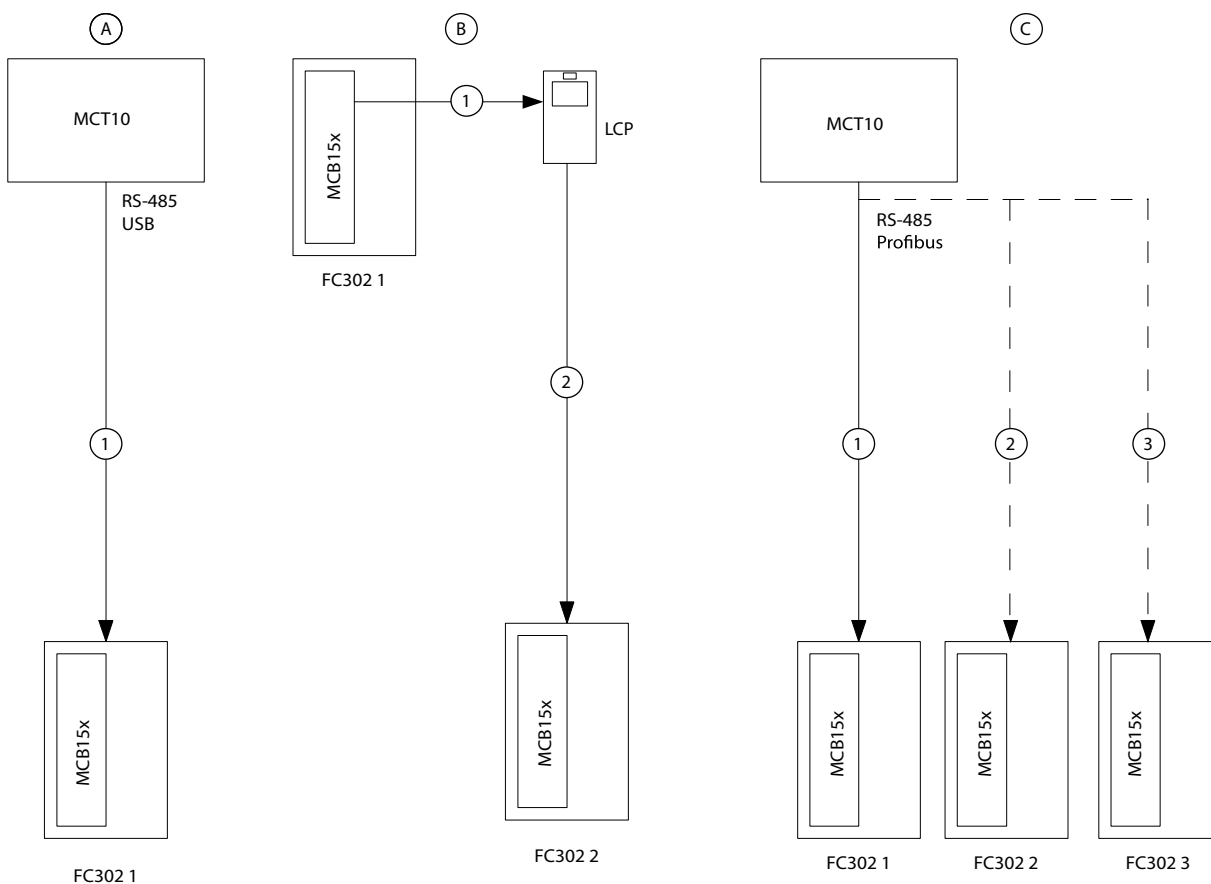
6.4 Commissioning Test

The commissioning test for systems with safety functions is focused on validating the functionality of safety monitoring and stop functions configured in the drive system.

The test objective is to verify proper configuration of the defined safety functions and of test mechanisms and to examine the response of specific monitoring functions to the explicit input of values outside tolerance limits. The test must cover all drive-specific Safety configured monitoring functions running in the final set-up.

6.4.1 Safety Guidelines

When commissioning/recommissioning, note the following

- Secure the site in accordance with the regulations (barrier, warning signs etc.). The system may only

be commissioned/recommissioned by qualified personnel.

- Refer to the information and specifications stated in the operating instructions of the relevant programmable control system.
- During commissioning/recommissioning, make sure that no personal injury and/or material damage can occur, even if the plant/machine moves unintentionally.
- When commissioning the safety option MCB 15x, read the safety guidelines in the *Start up and Functional Testing* chapter in the operating instructions for the frequency converter.

6.4.2 Condition before Performing the Commissioning Test

The system integrator/machine manufacturer performs a commissioning test of the MCB 15x to verify and document the correct selection of the MCB 15x parameter values. The system integrator/machine manufacturer

hereby proves to have tested the effectiveness of the safety functions used. The commissioning test must be performed on the basis of the risk analysis. All applicable standards and regulations must be adhered to.

- The machine is properly wired
- Check the effectiveness of all safety components used in the application
- All safety equipment such as protective door monitoring devices, light barriers or emergency stop switches is connected and ready for operation
- All motor parameters and command parameters must be set correctly on the frequency converter

A commissioning test of the MCB 15x must be performed in the following situations

- After the configuration of each machine
- After changing the MCB 15x parameters
- After making changes to the machine (as per applicable standards and regulations)

Check the effectiveness of all safety functions used.

1. Document each individual step of the test.
2. Note the checksum of the MCB 15x parameters in the records.
3. Do NOT release the system unless it has successfully passed all individual steps of the test.
4. Restart the frequency converter and check that the motor runs normally.

6.4.3 Safety Functions of the Frequency Converter

Commissioning test report

After making e.g. LCP Copy of safe parameters a commissioning test is required. Use this short version of the commissioning test report to follow and approve the test sequence.

Safety functions	Test procedure	Approved <input checked="" type="checkbox"/>
Safe Torque Off (STO)	1. Safe Torque Off function must be disabled via DI1. via DI2. Check the Safe Torque Off circuit connections against the circuit diagram.	
	2. No safety faults and alarms.	
	3. Run the frequency converter.	
	4. Ensure that the correct frequency converter is running.	
	5. Select Safe Torque Off while the frequency converter is running.	
	6. Check the following The frequency converter coasts to zero speed. The motor is braked and stopped by the mechanical brake (if available and configured). Warning/Alarm 68 is displayed.	
	7. Deselect Safe Torque Off.	
	8. Check the following Depending on the configuration, Safety Func. Pending is displayed. Safe Torque Off deselected and inactive.	
	9. Restart the frequency converter and check that the motor runs normally.	
	10. Ensure that the Safe Torque Off function is safe and accepted to operate.	
	11. Document and sign the commissioning test report.	

Table 6.3

Safety functions	Test procedure	Approved <input checked="" type="checkbox"/>
Safe Stop 1 time based (SS1)	1. Safe Stop 1 function must be disabled via DI1. via DI2. Check the Safe Stop 1 circuit connections against the circuit diagram.	
	2. No safety faults and alarms.	
	3. Run the frequency converter.	
	4. Ensure that the correct frequency converter is running.	
	5. Select Safe Stop 1 while the frequency converter is running.	
	6. Check the following The frequency converter ramps down to zero speed. Ensure that it stops within the delay time specified. The motor is braked and stopped by the mechanical brake (if available and configured). The SS1 will end with an STO warning or alarm, depending on configuration.	
	7. Deselect Safe Stop 1.	
	8. Check the following Safety Func. Pending is displayed. Safe Stop 1 deselected and inactive.	
	9. Restart the frequency converter and check that the motor runs normally.	
	10. Ensure that the Safe Stop 1 function is ready to operate.	
	11. Document and sign the commissioning test report.	

Table 6.4

Safety functions	Test procedure	Approved <input checked="" type="checkbox"/>
Safe Stop 1 Delay	1. Safe Stop 1 Delay function must be disabled via DI1. via DI2. Check the Safe Stop 1 circuit connections against the circuit diagram.	
	2. No safety faults and alarms.	
	3. Run the frequency converter.	
	4. Ensure that the correct frequency converter is running.	
	5. Select Safe Stop 1 Delay while the frequency converter is running.	
	6. Check the following The frequency converter ramps down to zero speed. Ensure that it stops within the delay time specified. The motor is braked and stopped by the mechanical brake (if available and configured). The SS1 will end with an STO warning or alarm depending on configuration.	
	7. Deselect Safe Stop 1 Delay.	
	8. Check the following Safety Func. Pending is displayed. Safe Stop 1 Delay deselected and inactive.	
	9. Restart the frequency converter and check that the motor runs normally.	
	10. Ensure that the Safe Stop 1 function is ready to operate.	
	11. Document and sign the commissioning test report.	

Table 6.5

Safety functions	Test procedure	Approved <input checked="" type="checkbox"/>
Safe Stop 1 ramp based (SS1)	1. Safe Stop 1 function must be disabled via DI1. via DI2. Check the Safe Stop 1 circuit connections against the circuit diagram.	
	2. No safety faults and alarms.	
	3. Run the frequency converter.	
	4. Ensure that the correct frequency converter is running.	
	5. Select Safe Stop 1 while the frequency converter is running.	
	6. Check the following The frequency converter ramps down to zero speed. The motor is braked and stopped by the mechanical brake (if available and configured). The SS1 will end with an STO warning or alarm depending on configuration.	
	7. Deselect Safe Stop 1.	
	8. Check the following Safety Func. Pending is displayed. Safe Stop 1 deselected and inactive.	
	9. Restart the frequency converter and check that the motor runs normally.	
	10. Ensure that the Safe Stop 1 function is ready to operate.	
	11. Document and sign the commissioning test report.	

Table 6.6

Safety functions	Test procedure	Approved <input checked="" type="checkbox"/>
Safely Limited Speed (SLS) without ramp	1. Safely Limited Speed function must be disabled via DI1. via DI2. Check the Safe Stop 1 circuit connections against the circuit diagram.	
	2. No safety faults and alarms.	
	3. Run the frequency converter. Up and down ramps can be separately entered for JOG operation (JOG-Mode). This can be parameterised as part of the Quick Menu. The motor speed must be higher than the Safely Limited Speed selected, if the machine allows this	
	4. Ensure that the correct frequency converter is running.	
	5. Select Safely Limited Speed while the frequency converter is running.	
	6. Check the following The frequency converter coasts to zero speed if Safe Torque Off is selected as fault reaction. Run Safe Stop 1 if that is selected as fault reaction. The motor is braked and stopped by the mechanical brake (if available and configured). Ensure that Error 70 is displayed.	
	7. Deselect Safely Limited Speed.	
	8. Check the following Safety Func. Pending is displayed. Safely Limited Speed deselected and inactive.	
	9. Restart the frequency converter and check that the motor runs normally.	
	10. Ensure that the Safely Limited Speed function is ready to operate. Run motor below SLS limit Activate SLS Increase reference above SLS limit Make sure that SLS limit will not be exceeded	
	11. Document and sign the commissioning test report.	

Table 6.7

Safety functions	Test procedure	Approved <input checked="" type="checkbox"/>
Safely Limited Speed (SLS) with ramp	1. Safely Limited Speed function must be disabled via DI1. via DI2. Check the Safely Limited Speed circuit connections against the circuit diagram.	
	2. No safety faults and alarms.	
	3. Run the frequency converter. The motor speed must be higher than the Safely Limited Speed selected, if the machine allows this	
	4. Ensure that the correct frequency converter is running.	
	5. Select Safely Limited Speed while the frequency converter is running.	
	6. Check the following The speed ramps down according to the chosen ramp time/slope to Safely Limited Speed set point.	
	7. Deselect Safely Limited Speed.	
	8. Safe Func. Pending is displayed.	
	9. Run the frequency converter. The motor speed must be higher than the Safely Limited Speed selected, if the machine allows this	
	10. Ensure that the correct frequency converter is running.	
	11. Select Safely Limited Speed while the frequency converter is running.	
	12. Check the following The frequency converter ramps down to the Safe Limited Speed.	
	13. Deselect Safely Limited Speed.	
	14. Check the following No safety faults. Safe Func. Pending is displayed.	
	15. Reset the frequency converter and check that the motor runs normally.	
	16. Ensure that the Safely Limited Speed function is ready to operate.	
	17. Document and sign the commissioning test report.	

6

Table 6.8

Tester/Approver	Date: _____
	Signature: _____

Table 6.9

6.5 Disposal

6.5.1 Disposal Instruction

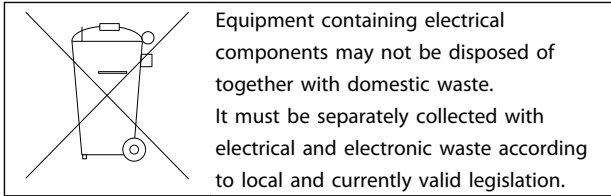

Table 6.10

7 Reset and Status over Fieldbus

7.1.1 Reset of MCB 15x Safe Option and Pending Safe Function

There are two different methods of performing a reset of MCB 15x and pending safe function. The configuration of 42-31 *Reset Source* is decisive for which method to use.

If 42-31 *Reset Source* is set to [0] *Drive Reset*, a reset according to the selected control word profile is required.

NOTE

The frequency converter specific alarms are also reset.

If 42-31 *Reset Source* is set to [1] *Drive Safe Reset*, [3] *Safe Option Reset* must be configured in 8-14 *Configurable Control Word CTW*.

NOTE

The frequency converter specific alarms will not be reset and the control word profile is overwritten.

7.1.2 Retrieving MCB 15x Safe Option Status

A subset of the MCB 15x status can be retrieved as part of the status word. It will change the behaviour selected as control word profile.

Configure [91] *Safe Opt. Reset. req.* and [90] *Safe Function active* in 8-13 *Configurable Status Word STW* to

- Indicate that a reset of the safe option is required
- Indicate that a safe function is active

42-80 *Safe Option Status* indicates the actual status (active safe function, any requests and error number) of the MCB 15x and is accessible as read only parameter from any interface or configurable as read process data for a specific fieldbus.

CAUTION

Only active safe function will be set in *Safe Option Status*.

Bit	Description
0	Normal_up
1	PUST
2	STO
3	SS1-a
4	SS1-b
5	SLS-a
6	SLS-b
7	Reserved for further SF
8	Reserved for further SF
9	Reserved for further SF
10	Reserved for further SF
11	Int_fail
12	Reset required
13	Pending fail safe state
14	Ext_fail
15	Safe function pending
16	General reset
17	Customisation_confirmed
18	Customisation_aborted
19	Customisation_requested
20	Suspension of speed monitoring
21	PUST warning
22	DI_1_offline_warning
23	DI_2_offline_warning
24	Error code
25	Error code
26	Error code
27	Error code
28	Error code
29	Error code
30	Error code
31	Error code

Table 7.1 Explanation of the Status Bits for Safe Option Status

Bit 00, Safety function deactive/active
 When bit 00 = "0", "Safety function, fail safe reaction is active or pending or warning is active"
 When bit 00 = "1", Normal Operation.

Bit 01, Power Up Self Test
 When bit 01 = "1", Safe Option is in PUST state.

Bit 02, Safe Torque Off
 When bit 02 = "0", Safe Torque Off is not active.
 When bit 02 = "1", Safe Torque Off is active.

Bit 03, Safe Stop 1 a
 When bit 03 = "0", Safe Stop 1-a is not active.
 When bit 03 = "1", Safe Stop 1-a is active.

Bit 04, Safe Stop 1 b

When bit 04 = "0", Safe Stop 1-b is not active.
When bit 04 = "1", Safe Stop 1-b is active.

Bit 05, Safely Limited Speed a

When bit 05 = "0", Safely Limited Speed-a is not active.
When bit 05 = "1", Safely Limited Speed-a is not active.

Bit 06, Safely Limited Speed b

When bit 06 = "0", Safely Limited Speed-b is not active.
When bit 06 = "1", Safely Limited Speed-b is not active.

Bit 07-10, For Future Safety functions reserved

Bit 11, Internal failure

When bit 11 = "0", No Internal failure is active.
When bit 11 = "1", Internal failure is active.

Bit 12, Reset

When bit 12 = "0", No Safe Option reset required
When bit 12 = "1", Safe Option reset required

Bit 13, Pending fail safe state

When bit 13 = "0", No pending fail safe state
When bit 13 = "1", Safe Option will be in this state at each power up.

Bit 14, External failure

When bit 14 = "0", No External failure is active.
When bit 14 = "1", External failure is active.

Bit 15, Safe function pending

When bit 15 = "0", No Safe function pending
When bit 15 = "1", Safe function pending

Bit 16, General Reset

When bit 16 = "0", No change in state
When bit 16 = "1", General Reset is done

Bit 17, Customization confirmed

When bit 17 = "0", No change in state
When bit 17 = "1", Customization confirmed by user

Bit 18, Customization aborted

When bit 18 = "0", No change in state
When bit 18 = "1", Customization aborted by user

Bit 19, Customization requested

When bit 19 = "0", No change in state
When bit 19 = "1", Customization is requested by user

Bit 20, Suspension of speed monitoring

When bit 20 = "0", No change in state
When bit 20 = "1", Suspension of speed monitoring – see error code

Bit 21, Power Up Self Test Warning

When bit 21 = "0", No change in state
When bit 21 = "1", Power Up Self Test Warning is issued

Bit 22, Digital Input 1 Offline Test Warning

When bit 22 = "0", No change in state
When bit 22 = "1", Digital Input 1 Offline Test Warning

Bit 23, Digital Input 2 Offline Test Warning

When bit 23 = "0", No change in state
When bit 23 = "1", Digital Input 2 Offline Test Warning

Bit 24-31, It contains reason for possible internal errors or external errors – see error code

42-81 *Safe Option Status 2* indicates which digital input of MCB 15x is either activated, in pending state or in blank initial state.

Bit	Description	State
0	DI1 Safety Status	00 - Inactive
1		01 - Active 10 - Pending
2	DI2 Safety Status	00 - Inactive
3		01 - Active 10 - Pending
4	Blank initial state	0 (inactive)/1 (active)
5	Unused	
31		

Table 7.2 Explanation for the Status Bits for Safe Option Status 2

Bit 00 - 01, DI1 Safety Status

When bit 00-01 = "00" Inactive
When bit 00-01 = "01" Active
When bit 00-01 = "11" Pending

Bit 02 - 03, DI2 Safety Status

When bit 00-01 = "00" Inactive
When bit 00-01 = "01" Active
When bit 00-01 = "11"

Pending Bit 04, Blank Initial Status

When bit 04 = "0" Safe Option is configured
When bit 04 = "1" Safe Option is in blank initial state

Bit 05-31, reserved for future use

8 Warnings and Alarms

This chapter provides troubleshooting tables for diagnosing fault conditions associated with the MCB 15x Safety Option.

The MCB 15x differentiates between the fault types shown in *Table 8.1*.

Fault type	Description	Effect on the system	Reset condition
Fatal Error	Severe exceptional error caused by the program run in the MCB 15x. Cyclic program sequence is no longer possible for safety related reasons. The last active function is displayed. The system is in stop mode.	Output S37 is switched off	Reset possible by power cycling the frequency converter or restart the MCB 15x via <i>42-90 Restart Safe Option</i>
Alarm	Functional fault, caused by an external process. Both systems continue to run cyclically and serve all requests from the communication interfaces. Sensing of the external process is also maintained.	Output S37 is switched off!	Reset possible via parameterizable input DI2, reset on LCP/DI or via Field bus or via <i>42-90 Restart Safe Option</i>

Table 8.1 Fault Types

Colour	Mode	Description
Green	Flashing	System OK, configuration validated
Green	Permanent	System OK, input or output activated
Yellow	Flashing	System OK, configuration not yet validated
Red	Flashing	Alarm
Red	Permanent	Fatal error

displayed in the expanded diagnostics system MCT 10.



Table 8.2 LED Status Indicators

All external failures can be removed by giving a reset signal (via LCP, DI2a and Digital inputs on Control Card or via Profibus depending on configuration). All internal failures can be removed by power cycle, *42-90 Restart Safe Option* and configuration.

8.1.1 Messages

Any errors on the MCB 15x are indicated on the frequency converter display with different messages

The following options are available for detailed diagnostics and fault detection

- LEDs on the front of the MCB 15x provide information on operating states. The LEDs are used to indicate the status of the option, i.e. active safety functions, failures and warnings, if any.
- LCP text or info via bus display the status of the safety functions (e.g. SS1a).

The following are displayed in online mode in the MCT 10 Set-up Software

- Status of MCB 15x inputs and output errors, messages and the corresponding remedies are

8.2 Warnings and Alarms

NOTE

The errors are not listed numerically.

Error No.	Description	Led Indications					
		Reason	Action	LED1	LED 2	LED4	
	Internal failure					Green Constant	
1	Diagnostic in progress					Green Constant	
67	Int Fail tolerance error exceeded: Reaction STO	<ul style="list-style-type: none"> Check that data for feedback (ppr., Type of feedback and gear ratio) are entered correctly Direction of feedback is wrong. Due to use of feedback filter the dynamic of the system does not match with dynamic of feedback filter (<i>42-15 Feedback Filter</i>). System is ramping too fast. Feedback signals are not received at all. No correction shielding of feedback cables. 	<ul style="list-style-type: none"> Make a re-customisation with correct data if needed Set <i>42-12 Encoder Direction</i> to the opposite value. Decrease ramping time on frequency converter Try to run the system at e.g. 60 RPM. If error nr. 99 now occurs, this is the reason. Improve shielding of feedback cables and motor cables. 			Status of LED 1 and LED2 depends on safety function state assigned to DI1 and DI2 respectively	Red Constant
68	Int fail Speed limit SS1a Ramp: Reaction STO	<ul style="list-style-type: none"> The value of ΔV is too small. For closed loop system it must often be larger than the recommended value. Due to use of feedback filter the dynamic of the system does not match with dynamic of feedback filter (<i>42-15 Feedback Filter</i>). Load change takes place during ramping. 	<ul style="list-style-type: none"> If running in closed loop, try to adjust PID setting and if needed increase SS1 ramping time. Try to increase <i>42-15 Feedback Filter</i>, but this might cause error nr. 67 to occur. Otherwise increase <i>42-45 Delta V</i>. 				Red Constant
69	Int fail Speed limit SS1b Ramp: Reaction STO	See 68	See 68				Red Constant

Table 8.3

Error No.	Description	Led Indications				
				LED1	LED 2	LED4
	Internal failure	Reason	Action			Green Constant
70	Int fail speed limit SLSa : Reaction STO	Happens during ramping to SLS limit, see 68. Happens during speed below SLS limit: <ul style="list-style-type: none"> If speed is above Cut Off speed at activation point and 42-53 Start Ramp is set to "No", this error occurs. Noise on the feedback signal (incl. quantisation noise) is larger than expected. Load change takes place, do as in above point) 	<ul style="list-style-type: none"> Change 42-53 Start Ramp to "Yes" and set 42-54 Ramp Down Time accordingly. Increase 42-50 Cut Off Speed or decrease 42-51 Speed Limit to get a larger tolerance 			Red Constant
134	Int fail speed limit SLSa: Reaction SS1a	See 70	See 70			Red Constant
198	Int fail speed limit SLSa :Reaction SS1b	See 70	See 70			Red Constant
71	Int fail speed limit SLSb : Reaction STO	See 70	See 70			Red Constant
135	Int fail speed limit SLSb :Reaction SS1a	See 70	See 70			Red Constant
199	Int fail speed limit SLSb :Reaction SS1b	See 70	See 70			Red Constant
72	Int Fail Processor Failure: Reaction STO	<ul style="list-style-type: none"> The two processors on MCB 15x have different safety states. CPU 2 fails 	<ul style="list-style-type: none"> First power cycle the frequency converter or restart the MCB 15x by 42-90 Restart Safe Option. Secondly try to make a general reset of the MCB 15x with the "Administration" button (MCB 15x goes back to blank initial state) If the problem persists, contact Danfoss 			Red Constant

Status of LED 1 and LED2 depends on safety function state assigned to DI1 and DI2 respectively

Table 8.4

Error No.	Description	Led Indications				
		Reason	Action	LED1	LED 2	LED4
	Internal failure					Green Constant
73	Int Fail safe output switch1: Reaction STO	Diagnostic of safe output of CPU 1 fails.	<ul style="list-style-type: none"> First power cycle frequency converter or restart the MCB 15x by <i>42-90 Restart Safe Option</i>. If the problem persists, contact Danfoss 			Red Constant
74	Int Fail safe output switch2: Reaction STO	Diagnostic of safe output of CPU 2 fails.	<ul style="list-style-type: none"> First power cycle frequency converter or restart the option by <i>42-90 Restart Safe Option</i>. If the problem persists, contact Danfoss 			Red Constant
75	Int Fail DI2 in PUST: Reaction STO	<ul style="list-style-type: none"> Safety input connected to DI2 has illegal signal level. Sensor is broken 	<ul style="list-style-type: none"> Check that configuration of DI2 (<i>42-21 Type</i> sub index [1]) is set correctly or the connected sensor is installed according to specification. 			Red Constant
76	Int Fail DI1 in PUST: Reaction STO	<ul style="list-style-type: none"> Safety input connected to DI1 has illegal signal level. Sensor is broken 	<ul style="list-style-type: none"> Check that the configuration of DI1 (<i>42-21 Type</i> sub index [1]) is set correctly or the connected sensor is installed according to specification. 			Red Constant
77	Int Fail failsafe data CRC mismatch: Reaction STO	The CRC of the MCB 15x does not match the stored CRC value on the frequency converter.	Configure the MCB 15x with MCT 10 safe plug-in or by CRC select/LCP copy			Red Constant
78	Int Fail S1S2CommChannel: Reaction STO	The communication between CPU 1 and CPU 2 fails.	<ul style="list-style-type: none"> First power cycle frequency converter or restart the MCB 15x by <i>42-90 Restart Safe Option</i>. If the problem persists, contact Danfoss 			Red Constant

Status of LED 1 and LED2 depends on safety function state assigned to DI1 and DI2 respectively

8

Table 8.5

Error No.	Description	Led Indications				
		Reason	Action	LED1	LED 2	LED4
	Internal failure					Green Constant
79	Int Fail No SPI comm: Reaction STO		Contact Danfoss			Red Constant
80	Int Fail No CAN comm: Reaction STO		Contact Danfoss			Red Constant
81	Int Fail under voltage Vuc1: Reaction STO	Voltage for CPU 1 is too low.	<ul style="list-style-type: none"> First power cycle frequency converter. If the problem persists, contact Danfoss 			Red Constant
82	Int Fail overvoltage Vuc1: Reaction STO	Voltage for CPU 1 is too high.	<ul style="list-style-type: none"> First power cycle frequency converter. If the problem persists, contact Danfoss 			Red Constant
83	Int Fail undervoltage 24 V IO: Reaction STO	Voltage for terminal 12 safe output is too low.	<ul style="list-style-type: none"> First power cycle frequency converter. If the problem persists, contact Danfoss 			Red Constant
84	Int Fail overvoltage 24v IO: Reaction STO	Voltage for terminal 12 safe output is too high.	<ul style="list-style-type: none"> First power cycle frequency converter. If the problem persists, contact Danfoss 			Red Constant
85	Int Fail undervoltage Vuc2: Reaction STO	Voltage for CPU 2 (GPIO) is too low.	<ul style="list-style-type: none"> First power cycle frequency converter. If the problem persists, contact Danfoss 			Red Constant
86	Int Fail overvoltage Vuc2: Reaction STO	Voltage for CPU 2 (GPIO) is too high.	<ul style="list-style-type: none"> First power cycle frequency converter. If the problem persists, contact Danfoss 			Red Constant
87	Int Fail undervoltage int5v: Reaction STO	Voltage used for other circuits than CPU is too low.	<ul style="list-style-type: none"> First power cycle frequency converter. If the problem persists, contact Danfoss 			Red Constant

Status of LED 1 and LED2 depends on safety function state assigned to DI1 and DI2 respectively

Table 8.6

Error No.	Description	Led Indications				
		Reason	Action	LED1	LED 2	LED4
	Internal failure					Green Constant
88	Int Fail overvoltage int5v: Reaction STO	Voltage used for other circuits than CPU is too high.	<ul style="list-style-type: none"> First power cycle frequency converter. If the problem persists, contact Danfoss 			Red Constant
89	Int Fail Memory Fail S2: Reaction STO	<ul style="list-style-type: none"> Data in EEPROM for CPU 2 is corrupted. The Flash memory fails. 	<ul style="list-style-type: none"> Try to perform a general reset of the MCB 15x with the "Administration" button. If the problem persists, contact Danfoss 			Red Constant
90	Int Fail Memory Fail S1: Reaction STO	<ul style="list-style-type: none"> Data in EEPROM for CPU 1 is corrupted. The Flash memory fails. 	<ul style="list-style-type: none"> Try to perform a general reset of the MCB 15x with the "Administration" button. If the problem persists, contact Danfoss 			Red Constant
91	Int Fail undervoltage Vuc2 PLL: Reaction STO	Voltage for CPU2 (PLL) s too low.	<ul style="list-style-type: none"> First power cycle frequency converter. If the problem persists, contact Danfoss 			Red Constant
92	Int Fail overvoltage Vuc2 PLL: Reaction STO	Voltage for CPU2 (PLL) is too high.	<ul style="list-style-type: none"> First power cycle frequency converter. If the problem persists, contact Danfoss 			Red Constant
93	Int Fail undervoltage Vuc2 Core: Reaction STO	Voltage for CPU2 (Core) s too low.	<ul style="list-style-type: none"> First power cycle frequency converter. If the problem persists, contact Danfoss 			Red Constant
94	Int Fail overvoltage Vuc2 Core: Reaction STO	Voltage for CPU2 (Core) is too high.	<ul style="list-style-type: none"> First power cycle frequency converter. If the problem persists, contact Danfoss 			Red Constant

Status of LED 1 and LED2 depends on safety function state assigned to DI1 and DI2 respectively

8

Table 8.7

Error No.	Description	Led Indications				
		Reason	Action	LED1	LED 2	LED4
	Internal failure					Green Constant
95	Int Fail undervoltage Vuc2 SDRAM: Reaction STO	Voltage for CPU2 (SDRAM) is too low.	<ul style="list-style-type: none"> First power cycle frequency converter. If the problem persists, contact Danfoss 	Status of LED 1 and LED2 depends on safety function state assigned to DI1 and DI2 respectively		Red Constant
96	Int Fail overvoltage Vuc2 SDRAM: Reaction STO	Voltage for CPU2 (SDRAM) is too high.	<ul style="list-style-type: none"> First power cycle frequency converter. If the problem persists, contact Danfoss 			Red Constant
97	Int Fail MOC Fail S1: Reaction STO		<ul style="list-style-type: none"> Contact Danfoss 			Red Constant
98	Int fail invalid customer file version	Version of customisation file of MCB 15x stored in EEPROM does not match the customisation file supported by the SW version of MCB 15x.	Do a new configuration with MCT 10 safe plug-in which supports the SW version of MCB 15x.			
99	Int Fail Feedback error	The connected feedback source does not give any signal.	Check to connection is done according to the specification or if the feedback source is broken.			Red
113	Ext Fail DI1 : Reaction STO	<ul style="list-style-type: none"> Safety input connected to DI1 has illegal signal level. Sensor is broken. 	Check that configuration of DI1 (42-21 Type sub index [0] is set correctly or the connected sensor is installed according to specification	Red Constant	Status depends on safety function state assigned to DI2	Red flashing, cycle (on 500 ms, off 500 ms)
177	Ext Fail DI1 :Reaction SS1a	See 113	See 113	Red Constant		Red flashing, cycle (on 500 ms, off 500 ms)
241	Ext Fail DI1 :Reaction SS1b	See 113	See 113	Red Constant		Red flashing, cycle (on 500 ms, off 500 ms)
114	Ext Fail DI2 : Reaction STO	<ul style="list-style-type: none"> Safety input connected to DI2 has illegal signal level. Sensor is broken 	Check that configuration of DI2 (42-21 Type sub index [1] is set correctly or the connected sensor is installed according to specification	Status depends on Safety function state assigned to DI1	Red Constant	Red flashing, cycle (on 500 ms, off 500 ms)

Error No.	Description	Led Indications				
				LED1	LED 2	LED4
178	Ext Fail DI2 :Reaction SS1a	See 114	See 114	Status depends on Safety function state assigned to DI1	Red Constant	Red flashing, cycle (on 500 ms, off 500 ms)
242	Ext Fail DI2 :Reaction SS1b	See 114	See 114	Status depends on Safety function state assigned to DI1	Red Constant	Red flashing, cycle (on 500 ms, off 500 ms)
115	Ext Fail Prec Thresh Timer Elapsed : Reaction STO	The frequency converter has been running below 120 RPM for more than the time entered in parameter 42-18 Zero Speed Timer with safe function SLS active.	Increase speed to above 120 RPM.	Status of LED 1 and LED2 depends on Safety function state assigned to DI1 and DI2 respectively		Red flashing, cycle (on 500 ms, off 500 ms)
179	Ext Fail Prec Thresh Timer Elapsed :Reaction SS1a	See 115	See 115			Red flashing, cycle (on 500 ms, off 500 ms)
243	Ext Fail Prec Thresh Timer Elapsed :Reaction SS1b	See 115	See 115			Red flashing, cycle (on 500 ms, off 500 ms)
116	Ext Fail SF activation Speed Suspension : Reaction STO	The frequency converter has been running below 120 RPM for more than 1 year and a safety function that need speed feedback is activated.	Increase speed to above 120 RPM.			Red flashing, cycle (on 500 ms, off 500 ms)
180	Ext Fail SF activation Speed Suspension: Reaction SS1a	See 116	See 116			Red flashing, cycle (on 500 ms, off 500 ms)
244	Ext Fail SF activation Speed Suspension :Reaction SS1b	See 116	See 116			Red flashing, cycle (on 500 ms, off 500 ms)
252	Safe Option Failure	In case of a dangerous failure the MCB 15x must bring the frequency converter into the fail-safe state which can be either External failure or internal failures.	Power cycle the frequency converter. If the problem persists, contact Danfoss			

Table 8.8

8.2.1 Safe Option Warning

MCB 15x warning messages

A warning message notifies that an issue exists on the MCB 15x. It is not handled as an internal or external failure. These messages are defined to indicate that a manual user action is required.

NOTE

At any possible failure or warning indicated from the MCB 15x, the LCP displays Warning 'Safe Option Failure [W252]' at the least.

8.2.2 Safe Option Reset Message

Requests for safe option RESET

For some messages, the MCB 15x requires an acknowledgement of an ongoing action or failure on the MCB 15x. The MCB 15x uses 'Safe Option RESET' as a 'Restart and Failure Acknowledgement'

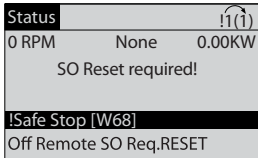
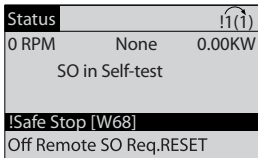
LCP message	Description
	<p>In the following cases the MCB 15x requests a 'Restart and Failure Acknowledgement' signal:</p> <ol style="list-style-type: none"> 1. MCB 15x Safe option is in 'Safety Function Pending' state (Remark: Occurs only if reset behaviour is set/ configured to 'manual') 2. After a power cycle with a 'Safety Function' 3. In PUST (power up self test), if an external failure occurred before power cycle 4. When an External failure occurred 5. When customization was aborted or completed 6. At the reception of an 'General Reset' (required after 'Blank Initial State' or in the 'Customization State'.)
	<p>MCB 15x indicates that it is PUST State (Power Up Self Test).</p> <ol style="list-style-type: none"> 1. Ensure that no safe function is active after a power cycle.

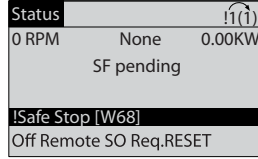
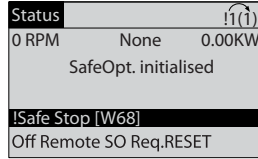
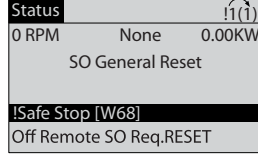
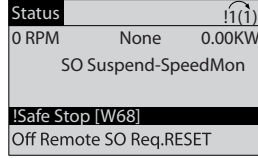
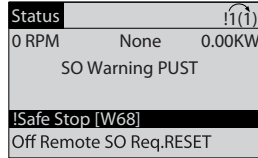
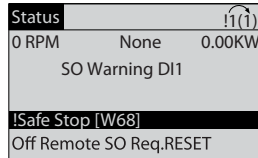
LCP message	Description
	<p>A safety function is pending at the start-up, if the frequency converter was powered down while a safety function was active. It is also pending, when the frequency converter was powered down while the MCB 15x has detected a failure during an active safety function.</p>
	<p>MCB 15x requests a 'Restart and Failure Acknowledge signal', which is always required after a PUST and when a safety function gets released and is configured to be confirmed that the motor is able to run.</p>
	<p>Occurs only if General Reset is performed from MCT 10. It is an indication to the user. The safe option is set to Blank initial state and safe parameters are set to default.</p>
	<p>Zero Speed Timer contains the remaining time until the Fail Prec Thresh Timer Elapsed after the monitoring time expires. The MCB 15x signals Warning.</p>
	<p>PUST warning has occurred. Warning cause: Expiry of PUST timer. Memory test required, perform power cycle.</p>
	<p>DI1 offline warning has occurred. Warning cause: Expiry of offline timer for DI1.</p>

LCP message	Description
	<p>130BD134.10</p> <p>DI2 offline warning has occurred. Warning cause: Expiry of offline timer for DI2.</p>
	<p>130BD131.10</p> <p>Speed monitoring suspension warning has occurred. Warning cause: Suspension of speed monitoring for certain duration.</p>

Table 8.9

9 Technical Specifications

MCB 150/MCB 151

Power consumption	2 W (equivalent power consumption related to VDD)
Current consumption VCC (5 V)	< 200 mA
Current consumption VDD (24 V)	< 30 mA (< 25 mA for MCB 150)

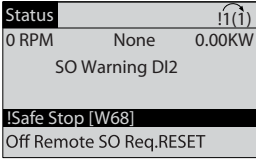
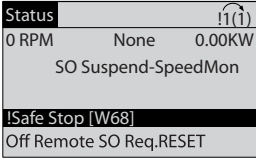
Digital inputs

Number of digital inputs	4 (2 x 2-channel Digital Safety Input)
Input voltage range	0 to 24 V DC
Input voltage, logic '0'	< 5 V DC
Input voltage, logic '1'	> 12 V DC
Input voltage (max)	28 V DC
Input current (min)	6 mA @Vin=24 V (inrush current 12 mA peak)
Input resistance	approx. 4 kΩ
Galvanic isolation	No
Short circuit-proof	Yes
Input pulse recognition time (min)	3 ms
Discrepancy time (min)	9 ms
Cable length	< 30 m (screened or unscreened cable) > 30 m (screened cable)

Digital output (Safe output)

Number of outputs	1
Output voltage low	< 2 V DC
Output voltage high	> 19.5 V DC
Output voltage (max)	24.5 V DC
Nominal output current (@24 V)	< 100 mA
Nominal output current (@0 V)	< 0.5 mA
Galvanic Isolation	No
Diagnostic test pulse	300 us
Short circuit-proof	Yes
Cable length	< 30 m (screened cable)

TTL encoder input (MCB 150)

Number of encoder inputs	4 (2 x differential inputs A/A; B/B)
Encoder types	TTL, RS-422/RS-485 incremental encoders
Input differential voltage range	-7 to +12 V DC
Input common mode voltage	-12 to +12 V DC
Input voltage, logic '0' (diff)	< -200 mV DC
Input voltage, logic '1' (diff)	> +200 mV DC
Input resistance	approx. 120 Ω
Maximum frequency	410 KHz
Short circuit-proof	Yes
Cable length	< 150 m (Tested with screened cable - Heidenhain AWM Style 20963 80°C 30V E63216, 100 m screened motor cable, no load on motor)

HTL encoder input (MCB 151)

Number of encoder inputs	2 (2 x single ended inputs A; B)
Encoder types	HTL incremental encoders; HTL Proximity sensor
Logic input	PNP
Input voltage range	0 to 24 V DC
Input voltage, logic '0'	< 5V DC
Input voltage, logic '1'	> 12 V DC
Input voltage (max)	28 V DC
Input resistance	approx. 4 Ω

Maximum frequency	110 kHz
Short circuit-proof	Yes
Cable length	< 100 m (Tested with screened cable - Heidenhain AWM Style 20963 80°C 30V E63216, 100 m screened motor cable, no load on motor)
24 V supply output	
Supply voltage	24 V DC (Voltage tolerance: +0.5 V DC to -4.5 V DC)
Maximum output current	150 mA
Short circuit-proof	Yes
Cable length	< 30 m (screened or unscreened cable) > 30 m (screened cable)
Ground I/O section	
Cable length	< 30 m (screened or unscreened cable) > 30 m (screened cable)
Cable cross sections	
Digital inputs/output supply voltage	0.75 mm ² /AWG 18, AEH without plastic collar in accordance with DIN 46228/1
Reset characteristics	
Manual reset time	≤ 5 ms (MCB 15x) ≤ 5 ms (frequency converter) ≤ 10 ms (fieldbus)
Manual reset pulse time	10 μs (MCB 15x and frequency converter)
Automatic reset time	≤ 4 ms
Start-up reset time	≤ 5 s (42-90 Restart Safe Option)
Response time	
Input to output response time	≤ 2 ms
Emergency stop until beginning of SS1/SLS	≤ 7 ms
Cross fault detection time	≤ 3 ms (@activated output)

9.1.1 Safety Characteristic Data

European directives	Machinery Directive (2006/42/EC)	EN ISO 13849-1 EN IEC 62061 EN IEC 61800-5-2	
	EMC Directive (2004/108/EC)	EN 50011 EN 61000-6-3 EN 61800-3	
	Low Voltage Directive (2006/95/EC)	EN 50178 EN 61800-5-1	
Safety standards	Safety of Machinery	EN ISO 13849-1 IEC 62061 IEC 60204-1	
	Functional Safety	IEC 61508-1 to -7 IEC 61800-5-2	
Safety function		IEC 61800-5-2	IEC 60204-1
		Safe Torque Off (STO)	Stop Category 0
		Safe Stop 1 (SS1)	Stop Category 1
		Safely Limited Speed (SLS)	
Safety performance	Safety Integrity Level	SIL 2 SIL CL2	
	HFT (IEC 61508)	Hardware Fault Tolerance = 1	
	Subsystem Classification	Type B	
	Probability of Dangerous Failure per Hour	PFH: 1,52 e-8	
	Probability of Dangerous Failure on Demand	PFD: 1,33 e-3	
	Category	Cat 3	
	Performance Level	PL d (cat 3)	
	Mean Time to Dangerous Failure of each Channel	MTTFd: 245 years (High)	
	Average Diagnostic Coverage	DC _{ave} : 86% (Low)	
	Safe Failure Fraction	SFF: 90%	
	Proof Test Interval	20 Years	

Table 9.1 Safety Characteristic Data

The safety-related characteristic data are valid for all safety functions.

All units used within a safety function must be considered when calculating the safety characteristic data.

Index

A	
Approvals.....	2
C	
Cable Length.....	25, 28
Category	
0 Stop.....	11, 12
1 Stop.....	11, 12, 13
Commissioning	
Software.....	34
Test.....	21, 34, 35, 42
Configuration.....	1, 4, 11, 14, 32, 33, 34, 41, 42, 57
Cross Section.....	28
D	
Digital Input.....	11, 12, 17, 18, 19, 20, 29, 57
Discrepancy.....	5, 20, 37
Disposal Instruction.....	54
E	
Encoder.....	5, 12, 15, 16, 19, 25, 28, 33, 34
Error Response.....	17, 18
F	
Feedback Source.....	32, 63
H	
HTL Encoder.....	7, 12, 28
M	
MCT 10 Safe Plug-in.....	13, 31, 33, 34, 42, 60, 63
O	
Option Change.....	42
P	
Password.....	42
PNP Proximity Switch.....	12, 21, 29
Priority.....	9
R	
Ramp.....	9, 13, 15, 17, 18, 22, 38, 39
Response Time.....	21
RS-485.....	28, 31, 34, 42
S	
Safe	
Motion Monitoring.....	10
Stop 1.....	5, 7, 9, 11, 12, 13, 15, 17, 19, 34
Torque Off.....	7, 9, 12, 13, 14, 15, 18, 19, 21, 22, 31, 34
Safely Limited Speed.....	5, 9, 11, 12, 13, 16, 18, 19, 34
Safety	
Control System.....	7, 9
Function.....	5, 9, 11, 12, 13, 14, 15, 16, 17, 18, 19, 20, 22, 31, 34
Sensor.....	11, 19
Sensor.....	1, 5, 7, 12, 19, 20, 29
Signal.....	2, 7, 12, 15, 19, 20, 21, 23, 25, 28, 33, 34, 57
SLS.....	5, 11, 16, 18, 19, 34, 36, 39, 64
S-ramp.....	14, 38
SS1	
SS1.....	19
Delay.....	13, 14
Ramp.....	13, 15, 17, 18, 58
STO.....	6, 12, 17, 19, 21
T	
Technical Specifications.....	67
Test Pulse Pattern.....	20, 37
TTL Encoder.....	7, 28
U	
USB.....	31, 34, 42
W	
Warnings And Alarms.....	57



www.danfoss.com/drives

Danfoss can accept no responsibility for possible errors in catalogues, brochures and other printed material. Danfoss reserves the right to alter its products without notice. This also applies to products already on order provided that such alterations can be made without subsequential changes being necessary in specifications already agreed. All trademarks in this material are property of the respective companies. Danfoss and the Danfoss logotype are trademarks of Danfoss A/S. All rights reserved.



