

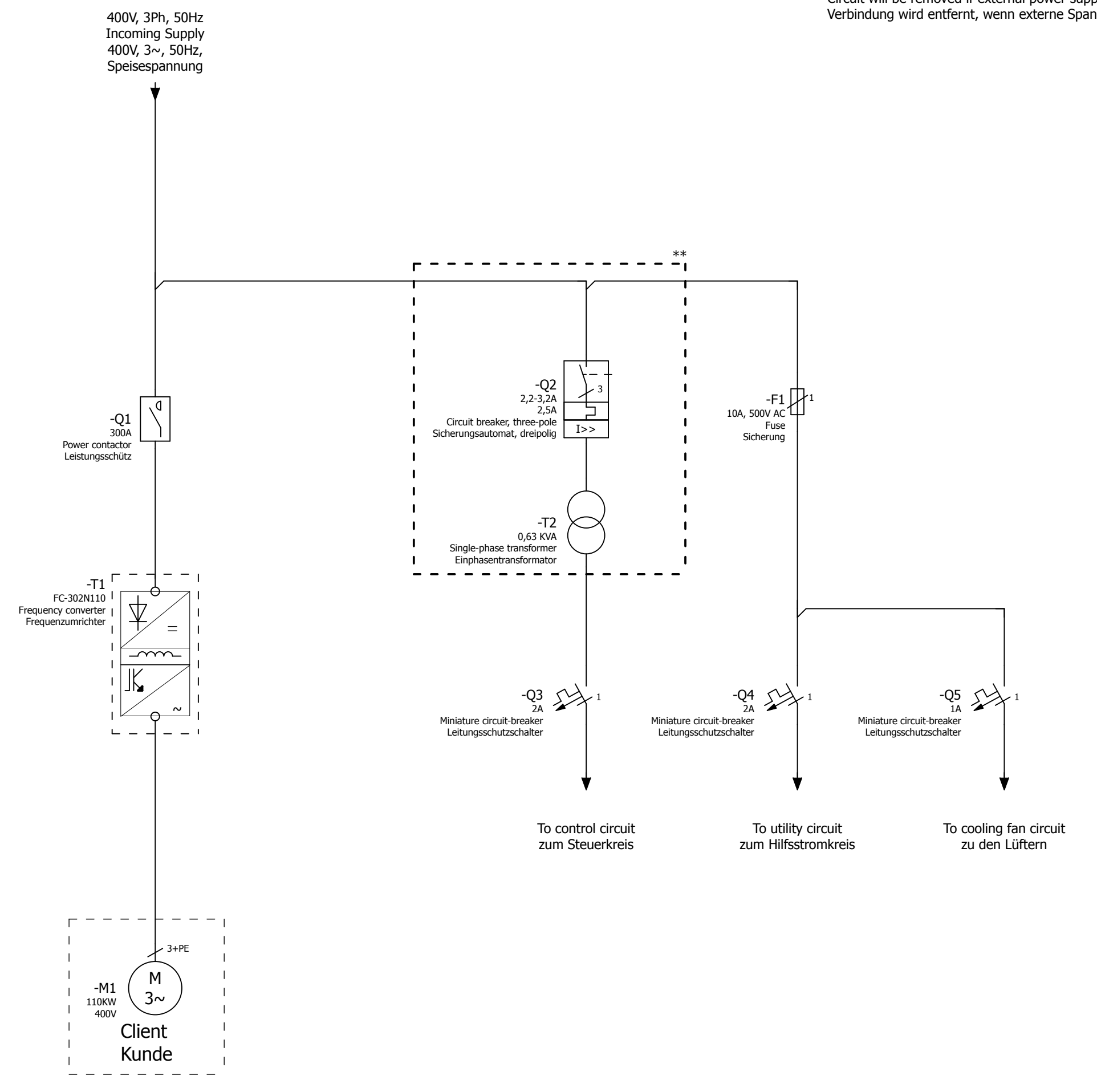

** - Circuit will be removed if external power supply considered
Verbindung wird entfernt, wenn externe Spannungsversorgung angelegt wird



=REPORT+CONNECTION LIST/3

Date		9/30/2013	Commission		Danfoss GmbH		FILE-NAME: LOGOB300.jpg Size 300px x 116px	Page description		Project Number	= FC302	Page
Ed.		----	Project description		VLT Drives EMA, Carl-Legien Strasse 8			Schematic single-line Schaltplan einpolig		-----	+ N110KW 230V	1
Appr.		----	Contactor		63073 Offenbach, Germany			SAP NO	Manufacturer no	Page		
Modification	Date	Name	Contr.	----	Schütz					33		