

VACON 10
AC DRIVES

QUICK GUIDE

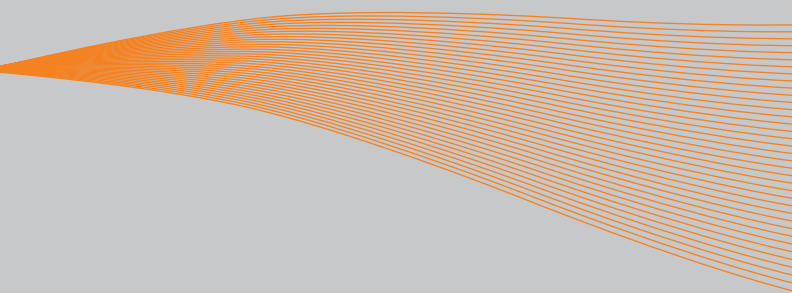

This quick guide includes the essential steps for easy installation and setup of your Vacon 10 frequency converter. Before commissioning your drive, download and read the complete Vacon 10 User Manual available at: www.vacon.com -> Support & Downloads

1. SAFETY



ONLY A COMPETENT ELECTRICIAN IS ALLOWED TO CARRY OUT THE ELECTRICAL INSTALLATION!

This quick guide contains clearly marked warnings which are intended for your personal safety and to avoid any unintentional damage to the product or connected appliances.

Please read these warnings carefully:



The components of the power unit of the frequency converter are live when Vacon 10 is connected to mains. Coming into contact with this voltage is extremely dangerous and may cause death or severe injury.



The motor terminals U, V, W (T1, T2, T3) and the possible brake resistor terminals -/+ are live when Vacon 10 is connected to mains, even if the motor is not running.



The control I/O-terminals are isolated from the mains potential. However, the relay output terminals may have a dangerous control voltage present even when Vacon 10 is disconnected from mains.



The earth leakage current of Vacon 10 frequency converters exceeds 3.5mA AC. According to standard EN61800-5-1, a reinforced protective ground connection must be ensured. **See Chapter 7!**



If the frequency converter is used as a part of a machine, the machine manufacturer is responsible for providing the machine with a main switch [EN 60204-1].



If Vacon 10 is disconnected from mains while running the motor, it remains live if the motor is energized by the process. In this case the motor functions as a generator feeding energy to the frequency converter.



After disconnecting the frequency converter from the mains, wait until the fan stops and the indicators on the display go out. Wait 5 more minutes before doing any work on Vacon 10 connections.



The motor can start automatically after a fault situation, if autorestart function has been activated.

2. INSTALLATION

2.1 Mechanical installation

There are two possible ways to mount Vacon 10 in the wall; either screw or DIN-rail mounting.

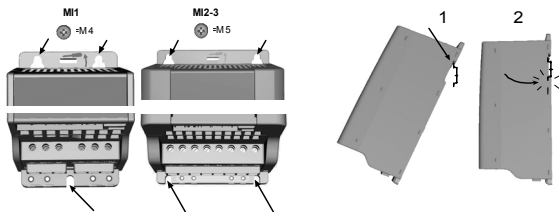

Figure 1: Screw mounting (left) and DIN-rail mounting (right)

NOTE! See the mounting dimensions on the back of the drive. Leave **free space** for cooling above (**4 in**) and below (**2 in**) Vacon 10, and on the sides (**4 in**) of Vacon 10! [Side-to-side installation allowed only if the ambient temperature is below 104F].

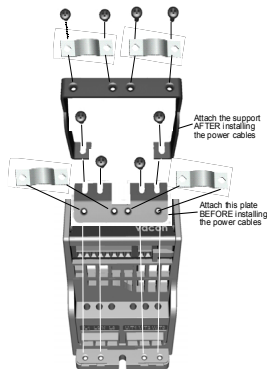

Figure 2: Attaching the PE-plate and API cable support

2.2 Cabling and connections

2.2.1 Power cabling

Note! Tightening torque for power cables is 4 - 5 in.-lbs.

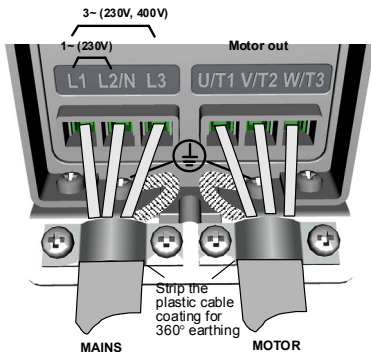

Figure 3: Vacon 10 power connections, MI1

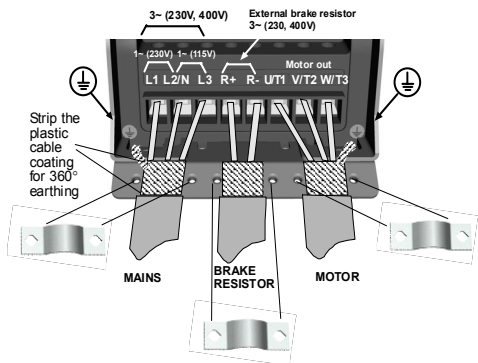

Figure 4: Vacon 10 power connections, MI2 - MI3

2.2.2 Control cabling

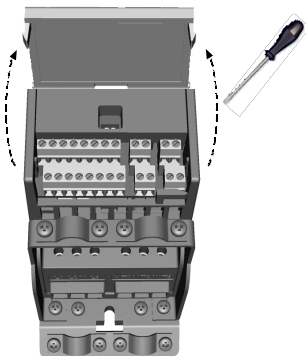

Figure 5: Open the cover

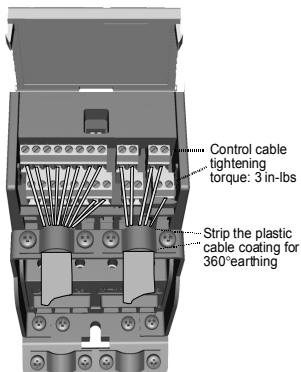
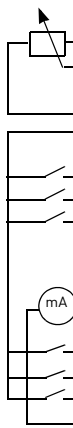

Figure 6: Install the control cables. See next page!

3. CONTROL I/O AND TERMINALS(API FULL)

Reference:

Potentiometer: 1-10K +/- 5%



Terminal	Signal	Factory preset	Description
1	+10Vref	Ref. voltage out	Maximum load 10 mA
2	AI1	Analog signal in 1	Freq. reference ^{P1} 0 - +10 V Ri = 200 kΩ (min)
3	GND	I/O signal ground	
6	24Vout	24V output for DI's	±20 % , max. load 50 mA
7	GND	I/O signal ground	
8	DI1	Digital input 1	Start forward ^{P1}
9	DI2	Digital input 2	Start reverse ^{P1}
10	DI3	Digital input 3	Preset speed B0 ^{P1}
A	A	RS485 signal A	FB Communication
B	B	RS485 signal B	FB Communication
4	AI2	Analog signal in 2	PI actual value ^{P1}
5	GND	I/O signal ground	0{4} - 20 mA, Ri = 200Ω
13	GND	I/O signal ground	
14	DI4	Digital input 4	Preset speed B1 ^{P1}
15	DI5	Digital input 5	Fault reset ^{P1}
16	DI6	Digital input 6	Disable PI control ^{P1}
18	AO	Analog signal out	Output frequency ^{P1} 0{4} - 20 mA, RL = 500Ω
20	DO	Digital signal out	Active = READY ^{P1} Open collector, max. load 48V/50mA
22	RO 13	Relay out 1	Active = RUN ^{P1} Max. switching load: 250Vac/2A or 250Vdc/0,4A
23	RO 14		
24	RO 22	Relay out 2	Active = FAULT ^{P1} Max. switching load: 250Vac/2A or 250Vdc/0,4A
25	RO 21		
26	RO 24		

Table 1: Vacon 10 General purpose application default I/O configuration and connections ,API Full(see information on other API's in User manual)

P) = Programmable function, see User manual, Parameters

Vacon 10 I/O terminals:

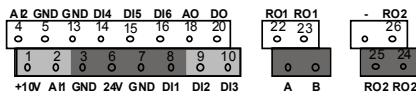

■ + ■ = API LIMITED

■ = API RS485

Tel. +1 877 822 6606 • Fax +1 717 264 3115

4. NAVIGATION & STARTUP

4.3 The main menus of Vacon 10

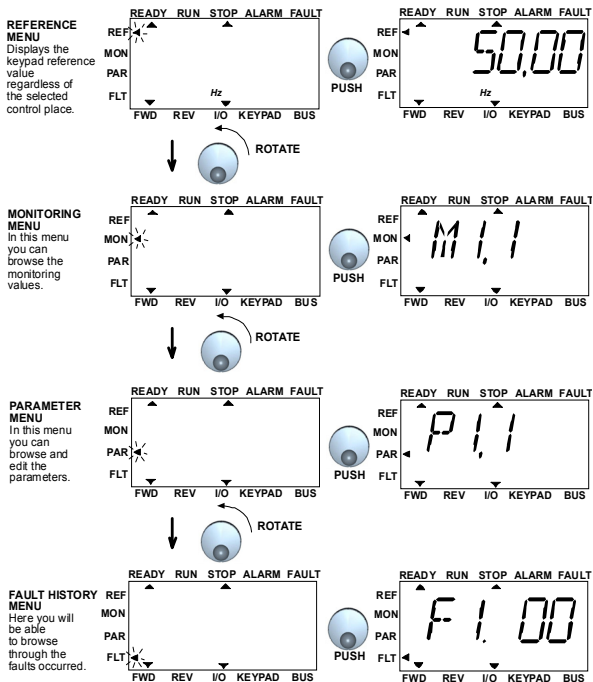

Figure 7: The main menu of Vacon 10

Note! You can quickly change the active control place from remote to local and back by pressing the navigation wheel for a few seconds!

4.4 Commissioning and startup wizard

4.4.1 Commissioning steps:

1. Read safety instructions on page 1	7. Perform test run without motor, see the User Manual at www.vacon.com
2. Secure the grounding and check that cables comply with requirements	8. Run no-load tests without motor being connected to the process
3. Check quality and quantity of cooling air	9. Perform an identification run (Par. ID631)
4. Check that all start/stop switches are in STOP position	10. Connect the motor to the process and perform test run once again
5. Connect the drive to mains	11. Vacon 10 is now ready for use
6. Run the Startup wizard and set all necessary parameters	

Table 2: Commissioning steps

4.4.2 Startup wizard

Vacon 10 runs the startup wizard in first power-up. After that the wizard can be run by pressing STOP for 5 seconds in main menu. The following figures show the procedure.

NOTE! Running the startup wizard will always return all parameter settings to their factory defaults!

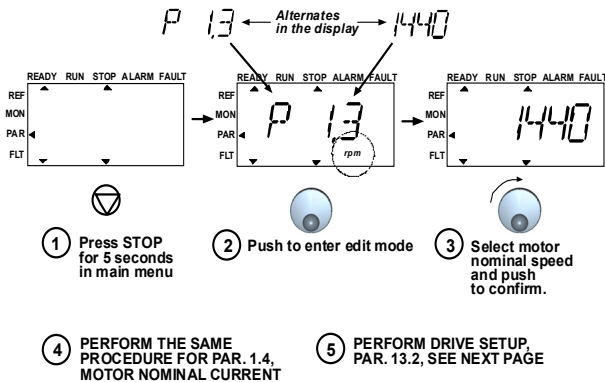
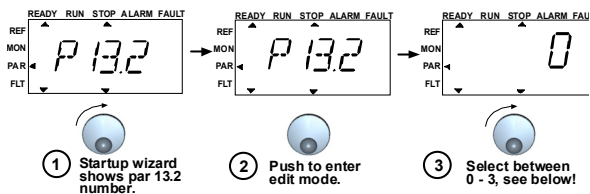

Figure 8: Vacon 10 startup wizard (General purpose application)

Selections:

	P1.1	P1.2	P1.7	P1.15	P2.1	P2.2	P2.3	P3.1	P3.2	P3.3	P4.2	P4.3
0 = Basic	V*	50/60 Hz	1,1 x I _{NMOT}	0= Not used	I/O	0= Ramp	0= Coast.	0 Hz	50/60 Hz	0= Ai1 0-10V	3 s	3 s
1 = Pump drive	V*	50/60 Hz	1,1 x I _{NMOT}	0= Not used	I/O	0= Ramp	1= Ramp	20 Hz	50/60 Hz	0= Ai1 0-10V	5 s	5 s
2 = Fan drive	V*	50/60 Hz	1,1 x I _{NMOT}	0= Not used	I/O	0= Ramp	0= Coast.	20 Hz	50/60 Hz	0= Ai1 0-10V	20 s	20 s
3 = Conveyor drive	V*	50/60 Hz	1,5 x I _{NMOT}	1= Used	I/O	0= Ramp	0= Coast.	0 Hz	50/60 Hz	0= Ai1 0-10V	1 s	1 s

*Same as drive voltage, except in 115V drives this value is 230V

Parameters affected:

P1.1 Motor Un (V)	P2.3 Stop function
P1.2 Motor fn (Hz)	P3.1 Min frequency
P1.7 Current limit (A)	P3.2 Max frequency
P1.15 Torque boost	P3.3 I/O reference
P2.1 Control place	P4.2 Acc. time (s)
P2.2 Start function	P4.3 Dec time (s)

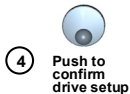
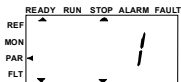

Figure 9: Drive setup

5. MONITORING & PARAMETERS

NOTE! Complete parameter listing and descriptions are given in Vacon 10 User Manual on: www.vacon.com -> Support & downloads.

5.1 Monitoring values

Code	Monitoring signal	Unit	ID	Description
M1.1	Output frequency	Hz	1	Frequency to the motor
M1.2	Frequency reference	Hz	25	
M1.3	Motor shaft speed	rpm	2	Calculated motor speed
M1.4	Motor current	A	3	Measured motor current
M1.5	Motor torque	%	4	Calculated actual/nominal torque of the motor
M1.6	Motor power	%	5	Calculated actual/nominal power of the motor
M1.7	Motor voltage	V	6	Motor voltage
M1.8	DC-link voltage	V	7	Measured DC-link voltage
M1.9	Unit temperature	°C	8	Heat sink temperature
M1.10	Motor temperature	%		Calculated motor temperature
M1.11	Analogue input 1	%	13	AI1 value
M1.12	Analogue input 2	%	14	AI2 value ONLY IN API FULL!
M1.13	Analogue output	%	26	AO1 ONLY IN API FULL!
M1.14	DI1, DI2, DI3		15	Digital input statuses
M1.15	DI4, DI5, DI6		16	Digital input statuses ONLY IN API FULL!
M1.16	RO1, (also RO2, DO in API FULL)		17	Relay/digital output statuses
M1.17	PI setpoint	%	20	In percent of the maximum process reference
M1.18	PI feedback	%	21	In percent of the maximum actual value
M1.19	PI error value	%	22	In percent of the maximum error value
M1.20	PI Output	%	23	In percent of the maximum output value

Table 3: Vacon 10 **API RS-485** monitoring values (General purpose application)

5.2 Quick setup parameters (Virtual menu, shows when par. 13.1 = 1)

Code	Parameter	Min	Max	Unit	Default	ID	Note
P1.1	Motor nominal voltage	180	690	V	230 400 575	110	Check rating plate on the motor
P1.2	Motor nominal frequency	30	320	Hz	50,00	111	Check rating plate on the motor
P1.3	Motor nominal speed	300	20000	rpm	1440	112	Default applies for a 4-pole motor.
P1.4	Motor nominal current	0,2 x I _{NUnit}	2,0 x I _{NUnit}	A	I _{NUnit}	113	Check rating plate on the motor
P1.5	Motor cos ϕ	0,30	1,00		0,85	120	Check rating plate on the motor
P1.7	Current limit	0,2 x I _{NUnit}	2 x I _{NUnit}	A	1,5 x I _{NUnit}	107	
P1.15	Torque boost	0	1		0	109	0 = Not used 1 = Used
P2.1	Remote control place	1	2		1	172	1 = I/O terminal 2 = Fieldbus (one selection removed)
P2.2	Start function	0	1		0	505	0 = Ramp 1 = Flying start
P2.3	Stop function	0	1		0	506	0 = Coasting 1 = Ramp
P3.1	Min frequency	0,00	P3.2	Hz	0,00	101	
P3.2	Max frequency	P3.1	320	Hz	50,00	102	
P3.3	I/O reference	0	4		3	117	0 = Preset Speeds [0-7] 1 = Keypad Reference 2 = Fieldbus Reference 3 = AI1 (API FULL & LIMITED) 4 = AI2 (API FULL)
P3.4	Preset speed 0	0,00	P3.2	Hz	5,00	124	Activated by digital inputs
P3.5	Preset speed 1	0,00	P3.2	Hz	10,00	105	Activated by digital inputs
P3.6	Preset speed 2	0,00	P3.2	Hz	15,00	106	Activated by digital inputs
P3.7	Preset speed 3	0,00	P3.2	Hz	20,00	126	Activated by digital inputs
P4.2	Acceleration time	0,1	3000	s	1,0	103	Acceleration time from 0 Hz to maximum frequency

Table 4: Quick setup parameters

Code	Parameter	Min	Max	Unit	Default	ID	Note
P4.3	Deceleration time	0,1	3000	s	1,0	104	Deceleration time from maximum frequency to 0 Hz.
P6.1	AI1 Signal range	0	3		0	379	API FULL and LIMITED: 0 = Voltage 0...10 V 1 = Voltage 2...10 V API LIMITED ONLY: 2 = Current 0...20 mA 3 = Current 4...20 mA NOTE: When using API LIMITED, select the voltage/current range also with the dip switch
P6.5	AI2 Signal range (API Full only)	2	3		3	390	2 = Current 0...20 mA 3 = Current 4...20 mA
P10.4	Fault autoreset	0	1		0	731	0 = Not used 1 = Used
P13.1	Parameter conceal	0	1		1	115	0 = All parameters visible 1 = Only quick setup parameter group visible

Table 4: Quick setup parameters

5.3 Motor settings (Control panel: Menu PAR -> P1)

NOTE! These parameters are shown, when P13.1 = 0.

Code	Parameter	Min	Max	Unit	Default	ID	Note
P1.1	Motor nominal voltage	180	690	V	230 400 575	110	Check rating plate on the motor
P1.2	Motor nominal frequency	30	320	Hz	50,00	111	Check rating plate on the motor
P1.3	Motor nominal speed	300	20000	rpm	1440	112	Default applies for a 4-pole motor.
P1.4	Motor nominal current	0,2 x I_{Nunit}	2,0 x I_{Nunit}	A	I_{Nunit}	113	Check rating plate on the motor
P1.5	Motor cos ϕ	0,30	1,00		0,85	120	Check rating plate on the motor
P1.7	Current limit	0,2 x I_{Nunit}	2 x I_{Nunit}	A	1,5 x I_{Nunit}	107	
P1.8	Motor control mode	0	1		0	600	0 = Frequency control 1 = Speed control
P1.9	U/f ratio selection	0	2		0	108	0 = Linear 1 = Squared 2 = Programmable
P1.10	Field weakening point	30,00	320	Hz	50,00	602	
P1.11	Voltage at field weakening point	10,00	200	%	100,00	603	% of Nominal voltage of the motor
P1.12	U/f curve midpoint frequency	0,00	P1.10	Hz	50,00	604	
P1.13	U/f curve midpoint voltage	0,00	P1.11	%	100,00	605	% of Nominal voltage of the motor
P1.14	Output voltage at zero frequency	0,00	40,00	%	0,00	606	% of Nominal voltage of the motor
P1.15	Torque boost	0	1		0	109	0 = Not used 1 = Used
P1.16	Switching frequency	1,5	16,0	kHz	6,0	601	
P1.17	Brake chopper	0	2		0	504	0=Disabled 1=Used in Run state 2=Used in Run and Stop state
Only in API FULL & LIMITED							
P1.18	Motor identification	0	1		0	631	1=Identification without run after start command

Table 5: Motor settings

5.4 Start/stop setup (Control panel: Menu PAR -> P2)

Code	Parameter	Min	Max	Unit	Default	ID	Note
P2.1	Remote control place	1	2		1	172	1 = I/O terminal 2 = Fieldbus (keypad control is activated with par. 2.5)
P2.2	Start function	0	1		0	505	0 = Ramp 1 = Flying start
P2.3	Stop function	0	1		0	506	0 = Coasting 1 = Ramp
P2.4	Start/Stop logic	0	3		0	300	Start signal 1 (Default DI1) Start signal 2 (Default DI2) 0 Start Fwd Start reverse 1 Start Reverse 2 Start Pulse Stop Pulse 3 Start Fwd Start Rv REAF REAF
P2.5	Local/remote	0	1			211	0 = Remote 1 = Keypad

Table 6: Start/Stop setup

5.5 Frequency references (Control panel: Menu PAR -> P3)

Code	Parameter	Min	Max	Unit	Default	ID	Note
P3.1	Min frequency	0,00	P3.2	Hz	0,00	101	
P3.2	Max frequency	P3.1	320	Hz	50,00	102	
P3.3	I/O reference	0	4		3	117	0 = Preset Speeds (0-7) 1 = Keypad Reference 2 = Fieldbus Reference 3 = AI1 (API FULL & LIMITED) 4 = AI2 (API FULL)
P3.4	Preset speed 0	0,00	P3.2	Hz	5,00	124	Activated by digital inputs
P3.5	Preset speed 1	0,00	P3.2	Hz	10,00	105	Activated by digital inputs
P3.6	Preset speed 2	0,00	P3.2	Hz	15,00	106	Activated by digital inputs
P3.7	Preset speed 3	0,00	P3.2	Hz	20,00	126	Activated by digital inputs
P3.8	Preset speed 4	0,00	P3.2	Hz	25,00	127	Activated by digital inputs
P3.9	Preset speed 5	0,00	P3.2	Hz	30,00	128	Activated by digital inputs
P3.10	Preset speed 6	0,00	P3.2	Hz	40,00	129	Activated by digital inputs
P3.11	Preset speed 7	0,00	P3.2	Hz	50,00	130	Activated by digital inputs

Table 7: Frequency references

NOTE! These parameters are shown, when P13.1 = 0

5.6 Ramps and brakes setup (Control panel: Menu PAR -> P4)

Code	Parameter	Min	Max	Unit	Default	ID	Note
P4.1	Ramp shape	0,0	10,0	s	0,0	500	0 = Linear >0 = S-curve ramp time
P4.2	Acceleration time	0,1	3000	s	1,0	103	
P4.3	Deceleration time	0,1	3000	s	1,0	104	
P4.4	DC braking current	0.2 x I _{Nunit}	2 x I _{Nunit}	A	Varies	507	
P4.5	DC braking time at start	0,00	600.00	s	0	516	0 = DC brake is off at start
P4.6	Frequency to start DC braking during ramp stop	0,10	10,00	Hz	1,50	515	
P4.7	DC braking time at stop	0,00	600.00	s	0	508	0 = DC brake is off at stop
P4.8	Flux brake enable	0	1		0	520	0 = Off 1 = On
P4.9	Flux braking current	0	7,4	A		519	
P4.10	Ramp shape 2	0,0	10,0	s	0,0	501	0 = Linear >0 = S-curve ramp time
P4.11	Acceleration time 2	0,1	3000	s	1,0	502	
P4.12	Deceleration time 2	0,1	3000	s	1,0	503	

Table 8: Ramps and brakes setup

5.7 Digital inputs (Control panel: Menu PAR -> P5)

Code	Parameter	Min	Max	Unit	Default	ID	Note
P5.1	Start signal 1	0	6		1	403	0 = Not used 1 = DI1
							2 = DI2 Only in API FULL & LIMITED 3 = DI3
							4 = DI4 Only in API FULL 5 = DI5 6 = DI6
P5.2	Start signal 2	0	6		2	404	As parameter 5.1
P5.3	Reverse	0	6		0	412	As parameter 5.1
P5.4	Ext. fault Close	0	6		0	405	As parameter 5.1
P5.5	Ext. fault Open	0	6		0	406	As parameter 5.1
P5.6	Fault reset	0	6		5	414	As parameter 5.1
P5.7	Run enable	0	6		0	407	As parameter 5.1
P5.8	Preset speed B0	0	6		3	419	As parameter 5.1
P5.9	Preset speed B1	0	6		4	420	As parameter 5.1
P5.10	Preset speed B2	0	6		0	421	As parameter 5.1
P5.11	Disable PI	0	6		6	1020	As parameter 5.1
P5.12	Force to I/O	0	1/6		0	409	As parameter 5.1
P5.13	Ramp time selection	0	6		0	408	As parameter 5.1

Table 9: Digital inputs

NOTE! These parameters are shown, when **P13.1 = 0**.

5.8 Analogue inputs (Control panel: Menu PAR -> P6)

Code	Parameter	Min	Max	Unit	Default	ID	Note
Only in API FULL & LIMITED							
P6.1	AI1 Signal range	0	3		0	379	API FULL and LIMITED: 0 = Voltage 0...10 V 1 = Voltage 2...10 V API LIMITED ONLY: 2 = Current 0...20 mA 3 = Current 4...20 mA NOTE: When using API LIMITED, select the voltage/current range also with the dip switch
P6.2	AI1 filter time	0,0	10,0	s	0,1	378	0 = no filtering
P6.3	AI1 Custom min	-100,0	100,0	%	0,0	380	0,0 = no min scaling
P6.4	AI1 Custom max	-100,0	100,0	%	100,0	381	100,0 = no max scaling
Only in API FULL							
P6.5	AI2 signal range	2	3		3	390	2 = Current 0...20 mA 3 = Current 4...20 mA
P6.6	AI2 filter time	0,0	10,0	s	0,1	389	0 = no filtering
P6.7	AI2 Custom min	-100,0	100,0	%	0,0	391	0,0 = no min scaling
P6.8	AI2 Custom max	-100,0	100,0	%	100,0	392	100,0 = no max scaling

Table 10: Analogue inputs

NOTE! These parameters are shown, when **P13.1 = 0**.

5.9 Digital and analogue outputs (Control panel: Menu PAR -> P7)

Code	Parameter	Min	Max	Unit	Default	ID	Selections
Only in API FULL							
P7.1	Relay output 1 content	0	11	P7.6	2	313	0 = Not used 1 = Ready 2 = Run 3 = Fault 4 = Fault Inverted 5 = Alarm 6 = Reversed 7 = At Speed 8 = Motor Regulator Active 9 = FBControlWord.Bit13 10 = FBControlWord.Bit14 11 = FBControlWord.Bit15
In all API versions							
P7.2	Relay output 2 content	0	11		3	314	As parameter 7.1
Only in API FULL							
P7.3	Digital output 1 content	0	11		1	312	As parameter 7.1
P7.4	Analogue output function	0	4		1	307	0 = Not in use 1 = Output freq. ($0-f_{max}$) 2 = Output current ($0-I_{nMotor}$) 3 = Torque (0-Nominal torque) 4 = PI controller output
P7.5	Analogue output minimum	0	1		1	310	0 = 0 mA 1 = 4 mA
Only in API Limited							
P7.6	Relay 2 invert	0	1		0	489	1 = Relay 2 inverted

Table 11: Digital and analogue inputs

NOTE! These parameters are shown, when **P13.1 = 0**.

5.10 Protections (Control panel: Menu PAR -> P9)

Code	Parameter	Min	Max	Unit	Default	ID	Note
P9.1	Response to 4mA reference fault	0	2		1	700	0 = No response 1 = Alarm 2 = Fault, stop acc. to P2.3
P9.2	Response to under voltage fault	1	2		2	727	1 = Alarm 2 = Fault, stop acc. to P2.3
P9.3	Earth fault protection	1	2		2	703	1 = Alarm 2 = Fault, stop acc. to P2.3
P9.4	Stall protection	0	2		1	709	0 = No response 1 = Alarm 2 = Fault, stop acc. to P2.3
P9.5	Underload protection	0	2		1	713	0 = No response 1 = Alarm 2 = Fault, stop acc. to P2.3
P9.7	Thermal protection of the motor	0	2		2	704	0 = No response 1 = Alarm 2 = Fault, stop acc. to P2.3
P9.8	Motor ambient temperature	-20	100	°C	40	705	
P9.9	Motor cooling factor at zero speed	0,0	150,0	%	40,0	706	
P9.10	Motor thermal time constant	1	200	min	45	707	
P9.11	Motor Phase Supervision	0	2	unit	2	702	0 = No response 1 = Warning 2 = Fault, stop mode after fault according to ID506(P2.3 Stop function)

Table 12: Protections

NOTE! These parameters are shown, when **P13.1 = 0**.

5.11 Fault autoreset parameters (Control panel: Menu PAR -> P10)

Code	Parameter	Min	Max	Unit	Default	ID	Note
P10.1	Wait time	0,10	10,00	s	0,50	717	Delay before automatic restart after a fault has disappeared
P10.2	Trial time	0,00	90,00 (FULL & LIMITED) 60,00 (RS485)	s	30,00	718	Defines the time before the frequency converter tries to automatically restart the motor after the fault has disappeared
P10.3	Start function	0	2		0	719	0 = Ramp 1 = Flying start 2 = According to P4.2 Affects only to start after autoreset!
P10.4	Fault auto reset	0	1		0	731	0 = Disabled 1 = Enabled

Table 13: Fault autoreset parameters

5.12 PI control parameters (Control panel: Menu PAR -> P12)

Code	Parameter	Min	Max	Unit	Default	ID	Note
P12.1	PI activation	0	2		0	163	0 = Not used 1 = PI for motor control 2 = PI for external use (Only in API FULL)
P12.2	PI controller gain	0,0	1000	%	100,0	118	
P12.3	PI controller I-time	0,00	320,0	s	10,00	119	
P12.4	Keypad PI reference	0,0	100,0	%	0,0	167	
P12.5	Setpoint source	0	3		0	332	0 = Keypad PI reference, P12.4 1 = Fieldbus 2 = AI1 Only in API FULL & LIMITED 3 = AI2 Only in API FULL
P12.6	Feedback source	0	2		2	334	0 = Fieldbus 1 = AI1 Only in API FULL & LIMITED 2 = AI2 Only in API FULL

Table 14: PI control parameters

Code	Parameter	Min	Max	Unit	Default	ID	Note
P12.7	Feedback minimum	0,0	100,0	%	0,0	336	0 = No minimum scaling
P12.8	Feedback maximum	0,0	100,0	%	100,0	337	100,0 = No maximum scaling
P12.9	Error value inversion	0	1		0	340	0=No inversion (Feedback<Setpoint->Increase PI Output) 1=Inverted (Feedback<Setpoint->Decrease PI Output)

Table 14: PI control parameters

5.13 Easy usage menu (Control panel: Menu PAR -> P0)

Code	Parameter	Min	Max	Unit	Default	ID	Note
P13.1	Parameter conceal	0	1		1	115	0 = All parameters visible 1 = Only quick setup parameter group visible
P13.2	Drive setup	0	3		0	540	0 = Basic 1 = Pump drive 2 = Fan drive 3 = Conveyor drive (HP) NOTE! Visible only during Startup wizard

Table 15: Easy usage menu

NOTE! These parameters are shown, when **P13.1 = 0**.

5.14 System menu parameters

Code	Parameter	Min	Max	Default	ID	Note
Software information (MENU PAR -> S1)						
S1.1	API system SW				2314	
S1.2	API system SW version				835	
S1.3	Power SW ID				2315	
S1.4	Power SW version				834	
S1.5	Application SW ID				837	
S1.6	Application SW revision				838	
S1.7	System load				839	
RS485 information (MENU PAR -> S2)						
S2.1	Communication status				808	Format: xx.yyy xx = 0 - 64 (Number of error messages) yyy = 0 - 999 (Number of correct messages)
S2.2	Fieldbus protocol	0	1	0	809	0 = FB disabled 1 = Modbus
S2.3	Slave address	1	255	1	810	
S2.4	Baud rate	0	5	5	811	0 =300, 1 =600, 2 =1200, 3 =2400, 4 =4800, 5 =9600,
S2.5	Number of stop bits	0	1	1	812	0 =1, 1 =2
S2.6	Parity type	0	0	0	813	0 = None (locked)
S2.7	Communication time-out	0	255	0	814	0 = Not used, 1 = 1 second, 2 = 2 seconds, etc.
S2.8	Reset communication status				815	1 = Resets par. S2.1
Total counters (MENU PAR -> S3)						
S3.1	MWh counter				827	
S3.2	Power on days				828	
S3.3	Power on hours				829	
User settings (MENU PAR -> S4)						
S4.1	Display contrast	0	15	7	830	Adjusts the display contrast
S4.2	Default page	0	20	0	2318	Defines which monitoring page (1.1. - 1.20) is shown after startup. 0 = Not used
S4.3	Restore factory defaults	0	1	0	831	1 = Restores factory defaults for all parameters

Table 16: System menu parameters

6. FAULT TRACING

Fault code	Fault name
1	Overcurrent
2	Overvoltage
3	Earth fault
8	System fault
9	Undervoltage
11	Output phase supervision
13	Frequency converter undertemperature
14	Frequency converter overtemperature
15	Motor stalled
16	Motor overtemperature
17	Motor underload
22	EEPROM checksum fault
25	Microcontroller watchdog fault
27	Back EMF protection
34	Internal bus communication
35	Application fault
41	IGBT Overtemperature
50	Analogue input $I_{in} < 4\text{mA}$ (selected signal range 4 to 20 mA)
51	External fault
53	Fieldbus fault
57	Identification fault

Table 1: Fault codes. See User Manual for detailed fault descriptions.

7. GENERAL DATA

Dimensions and weight	Frame	Height Width Depth (mm) Weight (kg)
	MI1	160,1 65,5 98,5 0,55
	MI2	195 90 101,5 0,70
	MI3	254,3 100 108,5 0,99
Supply network	Networks	Vacon 10 (400V) cannot be used with corner grounded networks
	Short circuit current	Maximum short circuit current has to be < 50kA
Motor connection	Output voltage	0 - U_{in}
	Output current	Continuous rated current I_N at ambient temperature max. +50°C (depends on the unit size), overload 1.5 x I_N max. 1min/10min
	Starting current / torque	Current 2 x I_N for 2 secs in every 20 sec period. Torque depends on motor
	Output frequency	0...320 Hz
Ambient conditions	Frequency resolution	0,01 Hz
	Ambient operating temperature	-10°C (no frost)...+50°C: rated loadability I_N
	Storage temperature	-40°C...+70°C
	Enclosure class	IP20
	Relative humidity	0...95% RH, non-condensing, non-corrosive, no dripping water
	Air quality: - chemical vapours - mech. particles	IEC 721-3-3, unit in operation, class 3C2 IEC 721-3-3, unit in operation, class 3S2
	Altitude	100% load capacity (no derating) up to 1000m. 1% derating for each 100m above 1000m; max. 2000m
	Vibration: EN60068-2-6	3...150 Hz Displacement amplitude 1[peak] mm at 3...15.8 Hz Max acceleration amplitude 1 G at 15.8...150 Hz
Shock IEC 68-2-27	UPS Drop Test (for applicable UPS weights) Storage and shipping: max 15 G, 11 ms (in package)	
Pollution degree	PD2	
EMC	Immunity	Complies with EN50082-1, -2, EN61800-3
	Emissions (See detailed descriptions in Vacon 10 User Manual at: www.vacon.com)	115V: Complies with EMC category C4 230V: Complies with EMC category C2; With an internal RFI filter 400V: Complies with EMC category C2; With an internal RFI filter 575V: Complies with EMC category C4 All: No EMC emission protection (Vacon level N): Without RFI filter
Standards		For EMC: EN61800-3, For safety: UL508C, EN61800-5-1
Certificates and manufacturer's declarations of conformity		For safety: CB, CE, UL, cUL, For EMC: CE, CB, c-tick (see unit nameplate for more detailed approvals)

Cable and fuse requirements (See detailed data in Vacon 10 User Manual at: www.vacon.com) 380 - 480V 208-240V 3-575V	Frame	Fuse [A]	Mains cable Cu (mm ²)	Terminal cable min-max (mm ²)	
				Main & earth	Control & relay
115V 208 - 240V 1-	MI1	6	3*1.5+1.5	1.5-4	0.5-1.5
	MI2	10			
	MI3	20	3*2.5+2.5	1.5-6	
	MI1	10	2*1.5+1.5	1.5-4	
	MI2	20	2*2.5+2.5		
	MI3	32	2*6+6	1.5-6	

- With above-mentioned fuses, the drive can be connected to power supply the short circuit current of which is max. 50kA
- Use cables with heat resistance of at least +70°C.
- The fuses function also as cable overload protection.
- These instructions apply only to cases with one motor and one cable connection from the frequency converter to the motor.
- To fulfil standard EN61800-5-1, the protective conductor should be **at least 10mm² Cu or 16mm AL**. Another possibility is to use an additional protective conductor of at least the same size as the original one.

Vacon 10 power ratings

Mains voltage 115 V, 50/60 Hz, 1~ series					
Frequency converter type	Rated loadability		Motor shaft power P [HP]	Nominal input current [A]	Mechanical size
	100% contin. current I _N [A]	150% overload current [A]			
0001	1,7	2,6	0.33	9,2	MI2
0002	2,4	3,6	0.5	11,6	MI2
0003	2,8	4,2	0.75	12,4	MI2
0004	3,7	5,6	1	15	MI2
0005	4,8	7,2	1.5	16,5	MI3

Mains voltage 208-240 V, 50/60 Hz, 1~ series					
Frequency converter type	Rated loadability		Motor shaft power P [kW]	Nominal input current [A]	Mechanical size
	100% contin. current I_N [A]	150% overload current [A]			
0001	1,7	2,6	0,25	4,2	MI1
0002	2,4	3,6	0,37	5,7	MI1
0003	2,8	4,2	0,55	6,6	MI1
0004	3,7	5,6	0,75	8,3	MI2
0005	4,8	7,2	1,1	11,2	MI2
0007	7,0	10,5	1,5	14,1	MI2
0009	9,6	14,4	2,2	22,1	MI3

Mains voltage 208-240 V, 50/60 Hz, 3~ series					
Frequency converter type	Rated loadability		Motor shaft power	Nominal input current	Mechanical size
	100% contin. current I_N [A]	150% overload current [A]	P [kW]	[A]	
Vacon 10-1L-0001-2	1,7	2,6	0,25	2,7	MI1
Vacon 10-1L-0002-2	2,4	3,6	0,37	3,5	MI1
Vacon 10-1L-0003-2	2,8	4,2	0,55	3,8	MI1
Vacon 10-1L-0004-2	3,7	5,6	0,75	4,3	MI2
Vacon 10-1L-0005-2	4,8	7,2	1,1	6,8	MI2
Vacon 10-1L-0007-2	7,0	10,5	1,5	8,4	MI2
Vacon 10-1L-0011-2	11	16,5	2,2	13,4	MI3

Mains voltage 380-480 V, 50/60 Hz, 3~ series					
Frequency converter type	Rated loadability		Motor shaft power	Nominal input current	Mechanical size
	100% continuous current I_N [A]	150% overload current [A]	380-480V supply P [kW]	[A]	
Vacon 10-3L-0001-4	1,3	2,0	0,37	2,2	MI1
Vacon 10-3L-0002-4	1,9	2,9	0,55	2,8	MI1
Vacon 10-3L-0003-4	2,4	3,6	0,75	3,2	MI1
Vacon 10-3L-0004-4	3,3	5,0	1,1	4,0	MI2
Vacon 10-3L-0005-4	4,3	6,5	1,5	5,6	MI2
Vacon 10-3L-0006-4	5,6	8,4	2,2	7,3	MI2
Vacon 10-3L-0008-4	7,6	11,4	3,0	9,6	MI3
Vacon 10-3L-0009-4	9,0	13,5	4,0	11,5	MI3
Vacon 10-3L-0012-4	12,0	18,0	5,5	14,9	MI3

Note: The input currents are calculated values with 100 kVA line transformer supply.

Mains voltage 575 V, 50/60 Hz, 3~ series					
Frequency converter type	Rated loadability		Motor shaft power P [HP]	Nominal input current [A]	Mechanical size
	100% contin. current I_N [A]	150% overload current [A]			
0002	1,7	2,6	1	2	M13
0003	2,7	4,2	2	3,6	M13
0004	3,9	5,9	3	5	M13
0006	6,1	9,2	5	7,6	M13
0009	9	13,5	10	10,4	M13
0011	11	16,5	10	14,1	M13

Note: The input currents are calculated values with 100 kVA line transformer supply.

Quick Modbus setup

1	A: Select Fieldbus as remote control place: P2.1 to 3 – Fieldbus B: Set Modbus RTU protocol to "ON": S2.2 to 1 – Modbus
2	A. Set Control Word to "0" (2001) B. Set Control Word to "1" (2001) C. Frequency converter status is RUN D. Set Reference value to "5000" (50,00%) (2003) E. Actual Speed is 5000 (25.00 Hz if MinFreq is 0.00 Hz and MaxFreq is 50.00 Hz) F. Set Control Word to "0" (2001) G. Frequency converter status is STOP

VACON

DRIVEN BY DRIVES

Find your nearest Vacon office
on the Internet at:

www.vacon.com

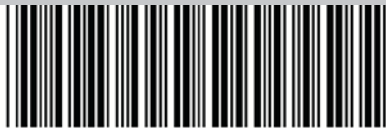

D P D 0 0 5 1 0