

VACON[®] NX

DC/DC DRIVES

ADFIF101

DC/DC CONVERTER

APPLICATION MANUAL

VACON[®]

Vacon NXP DC/DC Converter Application

INDEX

Document code: DPD01886B
Software code: ADFIF101V089
Date: 15.12.2020

VACON NXP DC/DC CONVERTER APPLICATION.....	3
1. Introduction.....	6
2. DC/DC Application compatibility issues.....	7
3. CONTROL IO.....	8
4. DC/DC Application – Monitoring Values.....	9
4.1 Monitoring values.....	10
4.1.1 Monitoring 1.....	10
4.1.2 Monitoring 2 values.....	10
4.1.3 Fieldbus values.....	11
4.1.4 Master-Follower values.....	11
4.1.5 Voltage Reference Chain.....	11
4.2 Monitoring Values description.....	12
4.2.1 Monitoring 1 values.....	12
4.2.2 Monitoring 2 values.....	13
4.2.3 Fieldbus monitoring values.....	15
4.2.4 Master-Follower monitoring values.....	19
4.2.5 Voltage Reference Chain.....	20
5. Parameter List.....	21
5.1 Basic parameters.....	21
5.2 Reference Handling.....	21
5.2.1 Reference Handling.....	21
5.2.2 Voltage Reference.....	21
5.2.3 Current Reference.....	22
5.2.4 Start Reference Handling.....	22
5.3 Input signals.....	23
5.3.1 Basic Settings.....	23
5.3.2 Digital inputs.....	23
5.3.3 Analogue Input 1.....	23
5.3.4 Analogue Input 2.....	24
5.3.5 Analogue Input 3.....	24
5.3.6 Analogue Input 4.....	24
5.4 Output signals.....	25
5.4.1 Digital Outputs.....	25
5.4.2 Analogue Output 1.....	26
5.4.3 Analogue Output 2.....	26
5.4.4 Delayed Digital Output 1.....	27
5.4.5 Delayed Digital Output 2.....	27
5.4.6 Output Options.....	27
5.5 Limit Settings.....	28
5.5.1 Current Limit.....	28
5.5.2 Under Voltage Control for DC-Link Voltage.....	28
5.5.3 Over Voltage Control for DC-Link Voltage.....	28
5.5.4 Source Voltage.....	28
5.6 DC Control Parameters.....	29

5.6.1	Inner control	29
5.6.2	Closed Loop.....	29
5.6.3	Voltage Feedback Signal	29
5.7	Drive Control parameters	30
5.7.1	Identification.....	30
5.7.2	System Test (Internal).....	30
5.7.3	Battery Emulator/Simulator.....	31
5.8	Master-Follower Parameters	31
5.9	Fieldbus parameters	32
5.10	Protections (Control keypad:	34
5.10.1	General.....	34
5.10.2	Temperature sensors	34
5.10.3	Thermal Protection	34
5.10.4	Fieldbus protection	34
5.10.5	Protection.....	34
5.11	ID Control Functions.....	35
5.11.1	Value Control	35
5.11.2	DIN ID Control 1	35
5.11.3	DIN ID Control 2	35
5.11.4	DIN ID Control 3	36
5.12	Keypad control (Control keypad: Menu M3).....	37
5.13	System menu (Control keypad: Menu M6)	37
5.14	Expander boards (Control keypad: Menu M7)	37
6.	Description of parameters.....	38
6.1	Basic parameters	38
6.2	Reference Handling	40
6.2.1	Voltage reference handling.....	41
6.2.2	Current reference handling.....	42
6.2.3	Start Reference Handling	43
6.3	Input Signals.....	44
6.3.1	Basic Settings	44
6.3.2	Digital Inputs.....	45
6.3.3	Analogue Inputs 1-4	46
6.4	Output Signals	50
6.4.1	Digital Outputs	50
6.4.2	Analogue Outputs 1 & 2	52
6.4.3	Delayed Digital Outputs 1 & 2.....	55
6.4.4	Output Options	56
6.5	Limit Settings.....	57
6.5.1	Current Limit	57
6.5.2	Under Voltage Control.....	58
6.5.3	Over Voltage Controller.....	59
6.5.4	Source Dc Voltage limits	60
6.6	DC Control.....	61
6.6.1	Inner Control Loop	61
6.6.2	Closed Loop.....	62
6.6.3	Voltage Feedback.....	63
6.7	Drive Control	64
6.7.1	Identification.....	65
6.7.2	System Test.....	66
6.7.3	Battery Emulator/Simulator.....	67
6.8	Master-Follower parameters	69
6.8.1	Master follower configuration	70
6.9	Fieldbus parameters.....	72
6.10	Protections.....	74
6.10.1	General.....	74

6.10.2	Temperature Sensors	75
6.10.3	Thermal Protection	76
6.10.4	Fieldbus protection	76
6.11	ID Function.....	78
6.11.1	Value Control	78
6.11.2	DIN ID Control.....	81
6.12	Keypad control	82
7.	Control and Status Words	83
7.1	FB Control Word with Basic In Bypass	83
7.2	FB Control Word with Standard	84
7.3	FB Status Word.....	85
7.4	Status Word (Application) ID 43.....	87
8.	Problem solving	89
9.	Fault codes.....	90

1. INTRODUCTION

This manual describes the DC/DC converter application software that can be used with Vacon NX products.

The DC/DC converter can be used to convert power between different DC-voltage levels. Typical applications are power conversion between battery and DC-link of a drive system or grid converter. The DC/DC converter can be used as a variable DC-voltage power supply.

This application requires the NXP3 control board and the VB761D version.

The capacitor and voltage measurements are optional, depending on the process requirements. The measurement itself can be given via analogue input or through fieldbus by power the management system. The measurement is used to smoothen the start, because the voltage control can be started at the correct level when it is known before start.

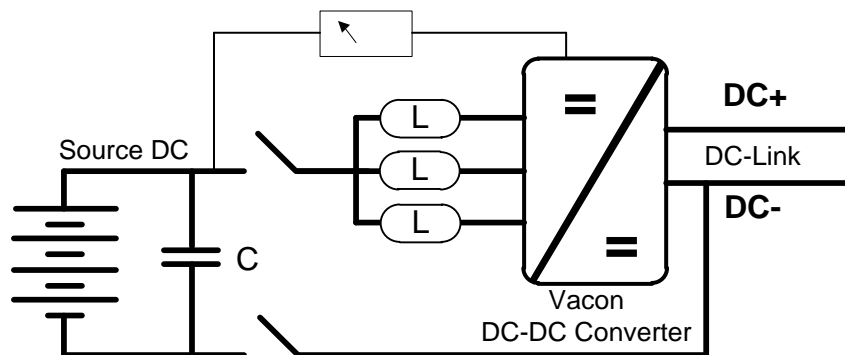

Figure 1, DC/DC connection

2. DC/DC APPLICATION COMPATIBILITY ISSUES

V053

- No Compatibility issues.

Note 1: This application parameters are not kept backwards compatible if new features or improvements would be difficult to implement by doing so. Read this change note and chapter “Compatibility issues in parameters between versions” from manual before updating the application.

Note 2: It's recommended to use compare function for parameter changes when updating application, especially in cases when version number change is considerably high. Application is constantly developed; this includes changing parameter default values, and if parameters are directly downloaded to drive improved default values may be lost.

3. CONTROL I/O



NXOPTA1			
Terminal	Signal		Description
1	+10V _{ref}	Reference voltage output	Voltage for potentiometer, etc.
2	AI1+	Analogue input 1. Range 0-10V, R _i = 200Ω Range 0-20 mA R _i = 250Ω	Analogue input 1 Input range selected by jumpers. Default range: Voltage 0 – 10 V
3	AI1-	I/O Ground	Ground for reference and controls
4	AI2+	Analogue input 2. Range 0-10V, R _i = 200Ω Range 0-20 mA R _i = 250Ω	Analogue input 2 Input range selected by jumpers. Default range: Current 0 – 20 mA
5	AI2-		
6	+24V	Control voltage output	Voltage for switches, etc. max 0.1 A
7	GND	I/O ground	Ground for reference and controls
8	DIN1	Start Request Programmable G2.3.1	Contact closed = Start Request
9	DIN2	Programmable G2.3.1	No function defined at default
10	DIN3	Fault Reset Programmable G2.3.1	Rising edge will reset active faults.
11	CMA	Common for DIN 1—DIN 3	Connect to GND or +24V
12	+24V	Control voltage output	Voltage for switches (see #6)
13	GND	I/O ground	Ground for reference and controls
14	DIN4	Programmable G2.3.1	No function defined at default
15	DIN5	Programmable G2.3.1	No function defined at default
16	DIN6	Programmable G2.3.1	No function defined at default
17	CMB	Common for DIN4—DIN6	Connect to GND or +24V
18	AOA1+	Analogue output 1 Programmable P2.3.1.2	Output range selected by jumpers. Range 0—20 mA. R _L , max. 500Ω Range 0—10 V. R _L > 1kΩ
19	AOA1-		
20	DOA1	Digital output Ready / Warning (Blinking)	Programmable Open collector, I _L ≤50mA, U _L ≤48 VDC
NXOPTA2			
21	RO1	RELAY OUTPUT 1 Programmable G2.4.1	Switching capacity 24 VCD / 8 A 250 VAC / 8 A 125 VDC / 0.4 A
22	RO1		
23	-RO1-		
24	RO2	Relay output 2	
25	RO2		
26	RO2		

Table 3-1. Default I/O configuration.

4. DC/DC APPLICATION – MONITORING VALUES

On the next pages you will find the lists of parameters within the respective parameter groups.

Column explanations:

Code	= Location indication on the keypad; Shows the operator the present parameter number
Parameter	= Name of parameter
Min	= Minimum value of parameter
Max	= Maximum value of parameter
Unit	= Unit of parameter value; given if available
Default	= Value preset by factory
Cust	= Customer's own setting
ID	= ID number of the parameter
	= On parameter code: Parameter value can only be changed after the Drive has been stopped.
	= Monitoring value is possible to control from fieldbus by ID number

The manual presents signals that are not normally visible for monitoring. i.e. is not a parameter or standard monitoring signal. These signals are presented with [a letter]. e.g.
[FW]MotorRegulatorStatus

[V]	Normal monitoring signal
[P]	Normal parameter in application.
[FW]	Firmware signal, Can be monitored with NCDrive when signal type is selected Firmware
[A]	Application signal, can be monitored with NCDrive when signal type is selected Application.
[R]	Reference type parameter on keypad.
[F]	Function. Signal is received as an output of function.
[DI]	Digital input signal.

4.1 Monitoring values

The monitoring values are the actual values of parameters and signals as well as statuses and measurements. Monitoring values cannot be edited.

4.1.1 Monitoring 1

Code	Signal	Unit	Form.	ID	Description
V1.1	Source Current	A	Varies	1104	
V1.2	Source Voltage	V	#, #	1107	Estimated at run state
V1.3	Active Current Reference	%	#, #	1704	
V1.4	Active Current	%	#, #	1125	Active current of the drive in % of Source Nominal Current > 0 Current from DC-Link To Source < 0 Current from Source to DC-Link
V1.5	Source DC Ref.	%	#, #, #	606	
V1.6	Source DC Act.	%	#, #, #	1873	Run state calculated, scaled.
V1.7	Source Meas. DC	%	#, #, #	1866	
V1.8	Source Meas. Vdc	Vdc	#, #	1164	Voltage feedback signal selected in P2.6.4.1
V1.9	DC-Link Current	%	#, #	1861	
V1.10	DC-Link Voltage	V	#	1108	Measured DC Link voltage in Volts, filtered
V1.11	DC-Link Act.	%	#, #, #	7	Percentage of source nominal voltage
V1.12	Unit Temperature	°C	#	1109	Heatsink temperature
V1.13	Status Word		#	43	

4.1.2 Monitoring 2 values

Code	Signal	Unit	Form.	ID	Description
V1.15.1	DC Voltage	V	#	44	Unfiltered
V1.15.2	Current	A	Varies	1113	Unfiltered
V1.15.3	IU Current	%	#, #	1851	
V1.15.4	IV Current	%	#, #	1852	
V1.15.5	IW Current	%	#, #	1868	
V1.15.6	Power kW	kW	Varies	1508	
V1.15.7	Discharging Limit	%	#, #	1855	
V1.15.8	Charging Limit	%	#, #	1854	
V1.15.9	Mindex	%	#, #, #	1856	
V1.15.10	Power Ref. %	%	#, #	1700	
V1.15.11	Power Act. %	%	#, #	5	
V1.15.12	DIN Status Word 1		#	56	
V1.15.13	DIN Status Word 2		#	57	
V1.15.14	Measured Temperature Max	°C	#, #	42	
V1.15.15	Meas. Temp 1	°C	#, #	51	
V1.15.16	Meas. Temp 2	°C	#, #	52	
V1.15.17	Meas. Temp 3	°C	#, #	53	

4.1.3 Fieldbus values

Code	Signal	Unit	Form.	ID	Description
V1.16.1	FB Control Word		#	1160	
V1.16.2	FB Voltage Reference	%	#,##	875	
V1.16.3	FB Status Word		#	68	
V1.16.4	FB Current Reference	%	#,#	1140	
V1.16.5	FB Power Reference	%	#,#	1141	
V1.16.6	Warning No.		#	74	
V1.16.7	Fault No.		#	37	
V1.16.8	Fault Word 1		#	1172	
V1.16.9	Fault Word 2		#	1173	
V1.16.10	Warning Word 1		#	1174	
V1.16.11	Analogue Input 1		#,##	13	
V1.16.12	Analogue Input 2		#,##	14	
V1.16.13	Analogue Input 3		#,##	27	
V1.16.14	Analogue Input 4		#,##	28	
V1.16.15	Analogue Output 1		#,##	26	
V1.16.16	Analogue Output 2		#,##	31	
V1.16.17	FB Analog Out	%	#,##	48	

4.1.4 Master-Follower values

Code	Signal	Unit	Form.	ID	Description
V1.17.1	Master CW		#	93	Master Control Word
V1.17.2	Status Word D1		#	1615	
V1.17.3	Status Word D2		#	1602	
V1.17.4	Status Word D3		#	1603	
V1.17.5	Status Word D4		#	1604	

4.1.5 Voltage Reference Chain

Code	Signal	Unit	Form.	ID	Description
V1.18.1	Source DC Ref In	%	#,##	1127	Voltage reference before ramp
V1.18.2	Source DC Ref.	%	#,##	606	Voltage reference after ramp
V1.18.3	Source Ref. Final	%	#,##	1131	
V1.18.4	Source Measured DC	%	#,##	1866	

4.2 Monitoring Values description

4.2.1 Monitoring 1 values

V1.1 Source Current A ID1104

Sum current of all phases.

V1.2 Source Voltage V ID1107

Estimated source voltage. Value is update when drive is in run state.

V1.3 Active Current Reference % ID1704

Active current reference of the drive in percentage of Source Nominal Current.

Active Curr. Ref > 0: Current flow from Drive DC-Link to Source.

Active Curr. Ref < 0: Current flow from Source to Drive DC-Link.

V1.4 Active Current % ID1125

Active current of the drive in percentage of Source Nominal Current

Active Current > 0: Current flow from Drive DC-Link to Source.

Active Current < 0: Current flow from Source to Drive DC-Link.

V1.5 Source DC Ref. % ID606

DC Reference for the DC Source Voltage. Percentage of Source Nom Voltage parameter.

V1.6 Source DC Act. % ID1873

DC Actual of the DC Source in percentage of Source Nom Voltage. Value is update when drive is in run state.

V1.7 Source Measured DC % #,## ID1866

Measured DC Voltage.

If Source DC voltage is available by external measurement make connection to this by Voltage feedback analogue input signal selected in P2.6.4.1.

If used Closed Loop Control and given trough fieldbus use Fast fieldbus communication and FB Process Data In 1 channel for actual value by connecting to this monitoring signal ID1866.

V1.8 Source Measured Vdc Vdc ID1164

Measured DC Voltage in Vdc for Closed Loop control and for starting voltage.

V1.9 DC-Link Current % ID1861

Calculated DC-Link Current in percentage of Source Nom Current.

V1.10 DC-Link Voltage V ID1108

Measured DC-link voltage in Vdc

V1.11 DC-Link Act. % ID7

Measured DC-Link voltage in percentage of Source Nom Voltage.

V1.12 Unit Temperature °C ID1109

The highest measured drive temperature.

V1.13 Status Word ID43

Application Status Word combines different drive statuses to one data word.

Application Status Word ID43		
	FALSE	TRUE
b0	Closed Loop Control not active	Closed Loop Control active
b1	Not in Ready state	Ready
b2	Not Running	Running
b3	No Fault	Fault
b4	Discharging disabled, low voltage	Discharging Allowed
b5	Charging Disabled, high voltage	Charging Allowed
b6	Run Disabled	Run Enable
b7	No Warning	Warning
b8		Charging Switch closed (internal)
b9		Over Voltage Regulator Active
b10		Under Voltage regulator active.
b11		
b12	No Run Request	Run Request
b13		One or more regulators active
b14	Current/Power Control Mode	Voltage Control Mode.
b15		

4.2.2 Monitoring 2 values**V1.15.1 DC Voltage V ID44**

Unfiltered DC-Link Voltage in V.

V1.15.2 Current A ID1113

Unfiltered source DC current in A.

V1.15.3 IU Current % ID1851

Unfiltered U phase current.

V1.15.4 IV Current % ID1852

Unfiltered U phase current.

V1.15.5 IW Current % ID1868

Unfiltered U phase current.

V1.15.6 Power kW kW ID1508

Calculated kW value of power flow.

V1.15.7 Discharge Limit % ID1855

Used Active discharge current limit, limit is showing 1/3 % of source nominal current. i.e. limit is per phase.

V1.15.8 Charging Limit % ID1854

Used Active charge current limit, limit is showing 1/3 % of source nominal current. i.e. limit is per phase.

V1.15.9 Mindex % ID 1856

Voltage reference as % of unit nominal voltage (500 V / 690 V)

V1.15.10 Power Ref. % % ID1700

Percentage power reference. Shown correctly when Power Control mode or Current Control mode active.

V1.15.11 Power Act. % % ID5

Percentage power value scaled to Source Nom Power parameter.

V1.15.12 DIN Status 1 ID 56**V1.15.13 DIN Status 2 ID 57**

	DIN StatusWord 1	DIN StatusWord 2
b0	DIN: A.1	DIN: C.5
b1	DIN: A.2	DIN: C.6
b2	DIN: A.3	DIN: D.1
b3	DIN: A.4	DIN: D.2
b4	DIN: A.5	DIN: D.3
b5	DIN: A.6	DIN: D.4
b6	DIN: B.1	DIN: D.5
b7	DIN: B.2	DIN: D.6
b8	DIN: B.3	DIN: E.1
b9	DIN: B.4	DIN: E.2
b10	DIN: B.5	DIN: E.3
b11	DIN: B.6	DIN: E.4
b12	DIN: C.1	DIN: E.5
b13	DIN: C.2	DIN: E.6
b14	DIN: C.3	
b15	DIN: C.4	

V1.15.14 Measured Temperature °C ID42

Maximum temperature of the first used measurement board.

4.2.3 Fieldbus monitoring values

See detail descriptions from chapter Control and Status words

V1.16.1 FB Control Word ID 1160

Control word from fieldbus. Below table is for bypass operation for such fieldbus board that natively supports this or can be parameterized to bypass mode. See details from chapter 8 Fieldbus profile for Vacon DC/DC Drive.

FB Control Word ID1160		
Bit	Signal	Comment
B00	DC Charge	0 = 1 = Charge DC
B01		
B02		
B03	Run	0 = DC/DC Converter is stopped 1 = DC/DC Converter is started
B04		
B05		
B06		
B07	Reset	0>1 Reset fault.
B08		
B09		
B10	PLC Control	0 = Disable FB Control 1 = Enable FB Control
B11	FB DIN1 / WD	Can be used to control RO or directly parameter by ID number. G2.4.1
B12	FB DIN2	Can be used to control RO or directly parameter by ID number. G2.4.1
B13	FB DIN3	Can be used to control RO or directly parameter by ID number. G2.4.1
B14	FB DIN4	Can be used to control RO or directly parameter by ID number. G2.4.1
B15		

V1.16.2 FB Voltage Reference [%] ID875

Voltage reference from fieldbus. Connection to here is made with ID number with Fieldbus data mapping.

V1.16.3 FB Status Word ID 68

Status word to fieldbus. Below table is for bypass operation for such fieldbus board that natively supports this or can be parameterized to bypass mode.

FB Status Word ID68		
	Signal	Comment
B00	Ready On	0=Drive not ready to switch on 1=Drive ready to start charging
B01	Ready Run	0=Drive not ready to run 1=Drive ready and Main Contactor is ON
B02	Running	0=Drive not running 1=Drive in Run state (Modulating)
B03	Fault	0=No active fault 1=Fault is active
B04	Run Enable Status	0= Run Disabled. Drive in stop state 1= Run Enabled. Drive can be started.
B05		
B06	Inhibit	0= Drive in operating condition. 1= Run disabled or fault state.
B07	Warning	0= No active warnings 1= Warning active
B08		
B09	Fieldbus Control Active	0=Fieldbus control not active 1=Fieldbus control active
B10		
B11		
B12		
B13		
B14		
B15	WD Pulse	Feedback from FB Control Word B11

V1.16.4 FB Current Reference [%] ID1140

Current reference from fieldbus. Connection to here is made with ID number with Fieldbus data mapping.

V1.16.5 FB Power Reference [%] ID1141

Power reference from fieldbus. Connection to here is made with ID number with Fieldbus data mapping.

V1.16.6 Warning No. ID74

Number if last active warning.

V1.16.7 Fault No. ID37

Number if last active fault.

V1.16.8 Fault Word 1 ID1172

Fault Word 1 ID1172	
Bit	Fault(s)
B0	F1 Over current, F31 IGBT, F41 IGBT
B1	F2 Over Voltage
B2	F9 Under Voltage
B3	
B4	F3 Earth Fault
B5	
B6	F14 Unit Over Temperature
B7	F29 Thermistor
B8	
B9	
B10	
B11	F52 Keypad or F52 PC communication fault
B12	F53 FieldBus fault
B13	
B14	F54 Slot Communication fault
B15	F50 4mA fault

V1.16.9 Fault Word 2 ID 1173

Fault Word 2 ID1173	
Bit	Fault(s)
B0	
B1	
B2	
B3	
B4	
B5	
B6	F51 External fault
B7	
B8	
B9	F31 IGBT, F41 IGBT
B10	
B11	
B12	
B13	
B14	
B15	

V1.16.10 Warning Word 1 ID 1174

Warning Word 1 ID1174	
Bit	Warning(s)
B0	
B1	W29 Thermistor
B2	
B3	
B4	
B5	
B6	F53 FB Warning
B7	
B8	F14 Over Temperature
B9	
B10	
B11	
B12	
B13	
B14	
B15	

V1.16.11 Analogue input 1 % **ID 13**

V1.16.12 Analogue input 2 % **ID 14**

Unfiltered analogue input level.

0 % = 0 mA / 0 V, -100 % = -10 V, 100 % = 20 mA / 10 V.

Monitoring scaling is determined by the option board parameter.

V1.16.13 Analogue input 3 % **ID 27**

V1.16.14 Analogue input 4 % **ID 28**

It is possible to adjust this input value from fieldbus when the input terminal selection is 0.1. This way it is possible to adjust the free analogue input from fieldbus and have all analogue input functions available for fieldbus process data.

V1.16.15 Analogue Out 1 % **ID 26**

V1.16.16 Analogue Out 2 % **ID 31**

Analogue Output value 0 % = 0 mA / 0 V, 100 % = 20 mA / 10 V

V1.16.17 FB Analog Out % **### ID48**

4.2.4 Master-Follower monitoring values

V1.17.1 Master CW ID93

SystemBus Master Control word that is send by master drive and received by follower drives.

Master Control Word ID93	
Signal	Comment
b0	
b1	
b2	
b3	Fault Reset
b4	Master Running
b5	
b6	
b7	WD Pulse
b8	
b9	Datalogger Trig command
b10	
b11	
b12	
b13	
b14	Voltage Control
b15	

- V1.17.2 Status Word D1 ID1615**
V1.17.3 Status Word D2 ID1602
V1.17.4 Status Word D3 ID1603
V1.17.5 Status Word D4 ID1604

Follower status words received by SystemBus master drive from followers.

Follower Status Word	
Signal	Comment
b0	
b1	Ready
b2	Run
b3	Fault
b4	Charge SW State
b5	
b6	Run Enable
b7	Warning
b8	
b9	
b10	Synchronized
b11	
b12	Run Request
b13	Limit Regulator
b14	
b15	WD Pulse

4.2.5 Voltage Reference Chain

V1.18.1 Source DC Ref. In % ID1127

DC Reference for the DC Source voltage before the ramp.

V1.18.2 Source DC Ref. % ID606

DC Reference for the DC Source Voltage after the ramp. Percentage of Source Nom Voltage parameter.

V1.18.3 Source Ref. Final % ID1131

DC Reference for the DC Source Voltage after Closed Loop PI controller.

V1.18.4 Source Measured DC % ID1866

Measured DC Voltage.

If Source DC voltage is available by external measurement make connection to this by Voltage feedback analogue input signal selected in P2.6.4.1.

If used Closed Loop Control and given through fieldbus use Fast fieldbus communication and FB Process Data In 1 channel for actual value.

5. PARAMETER LIST

5.1 Basic parameters

Code	Parameter	Min	Max	Unit	Default	ID	Note
P2.1.1	Source Nom Current	0,0	Varies	A	Varies	113	Capacity of supply,
P2.1.2	Source Nom Voltage	50	797 1099	V	400 690	110	
P2.1.3	Source Nom Power	0	32000	kW	0	116	
P2.1.4	Control Mode	0	2		0	1858	0 = Current 1 = Voltage 2 = Power
P2.1.5	Voltage Reference	0	320	%	100	1462	
P2.1.6	Current Reference	-150	150	%	0	1860	Common current reference
P2.1.7	Power Reference	-150	150	%	0	1869	Common power reference
P2.1.8	Identification	0	1		0	631	0 = No Action 1 = Current. Meas. Offset.

Table 5-1. Basic parameters

5.2 Reference Handling

5.2.1 Reference Handling

Code	Parameter	Min	Max	Unit	Default	ID	Note
P2.2.1	IO Control Mode	0	3		0	1856	0 = Control Mode P2.1.4 1 = Current Control 2 = Voltage Control 3 = Power Control
P2.2.2	IO Voltage Ref Sel.	0	1		0	117	0 = Voltage Ref. ID1462 1 = FB Voltage Ref. ID875
P2.2.3	IO Current Ref. Sel.	0	1		0	131	0 = Current Ref. ID1860 1 = FB Current Ref. ID1140
P2.2.4	IO Power Ref. Sel.	0	1		0	1620	0 = Power Ref. ID1869 1 = FB Power Ref. ID1141
P2.2.5	FB Control Mode	0	3		0	1848	0 = Control Mode ID1858 1 = Current Control 2 = Voltage Control 3 = Power Control
P2.2.6	FB Voltage Ref Sel.	0	1		0	112	0 = Voltage Ref. ID1462 1 = FB Voltage Ref. ID875
P2.2.7	FB Current Ref. Sel.	0	1		0	641	0 = Current Ref. ID1860 1 = FB Current Ref. ID1140
P2.2.8	FB Power Ref. Sel.	0	1		0	1621	0 = Power Ref. ID1869 1 = FB Power Ref. ID1141

Table 5-2. Current Reference Handling

5.2.2 Voltage Reference

Code	Parameter	Min	Max	Unit	Default	ID	Note
P2.2.9.1	Drooping	0	100	%	0	620	
P2.2.9.2	Voltage Reference Ramp Rate	-1	3200	%/s	5	1867	<0 = No ramp
P2.2.9.3	Direct Vdc Control	0	1		0	1743	0 = No 1 = Yes

Table 5-3. Voltage Reference Handling

5.2.3 Current Reference

Code	Parameter	Min	Max	Unit	Default	ID	Note
P2.2.10.1	Constant Reference 1	-320,00	320,00	%	0,0	1239	
P2.2.10.2	Constant Reference 2	-320,00	320,00	%	0,0	1240	
P2.2.10.3.1	Phase Reference Mode	0	2		0	1859	0 = Average 1 = Individual 2 = Same
P2.2.10.3.2	IU Current Reference	-300	300	%	0	128	
P2.2.10.3.3	IV Current Reference	-300	300	%	0	129	
P2.2.10.3.4	IW Current Reference	-300	300	%	0	130	

Table 5-4. Current Reference Handling

5.2.4 Start Reference Handling

Code	Parameter	Min	Max	Unit	Default	ID	Note
P2.2.11.1	Voltage Reference At Start	0	2		3	1864	0 = Reference 1 = Start Voltage Reference 2 = Measurement 3 = 80 %
P2.2.11.2	Start Voltage Reference	0	320	%	90	1865	

Table 5-4. Start Reference Handling

5.3 Input signals

5.3.1 Basic Settings

Code	Parameter	Min	Max	Unit	Default	ID	Description
P2.3.1.1	Start/Stop Logic	0	2		0	300	0 = Start-No Act 1 = RPuls-FPuls 2 = RPuls-RPuls

Table 5-5. Basic Settings

5.3.2 Digital inputs

Code	Parameter	Min	Max	Unit	Default	ID	Description
P2.3.1.1	Start Signal 1	0.1	E.10	DigIn	A.1	403	
P2.3.2.2	Start Signal 2	0.1	E.10	DigIn	0.1	404	
P2.3.2.3	Run Enable	0.1	E.10	DigIn	0.2	407	
P2.3.2.4	Fault Reset	0.1	E.10	DigIn	A.3	414	
P2.3.2.5	External fault	0.1	E.10	DigIn	0.1	405	
P2.3.2.6	External fault	0.1	E.10	DigIn	0.1	406	
P2.3.2.7	Enable Constant Ref	0.1	E.10	DigIn	0.1	532	
P2.3.2.8	Constant Ref. 1	0.1	E.10	DigIn	0.1	530	
P2.3.2.9	Constant Ref. 2	0.1	E.10	DigIn	0.1	531	
P2.3.2.1 0	I/O Term Control	0.1	E.10	DigIn	0.1	409	
P2.3.2.1 1	Keypad Control	0.1	E.10	DigIn	0.1	410	
P2.3.2.1 2	Fieldbus Control	0.1	E.10	DigIn	0.1	411	
P2.3.2.1 3	DC CB State	0.1	E.10	DigIn	0.1	1453	
P2.3.2.1 4	Thermal Switch	0.1	E.10	DigIn	0.2	1179	

Table 5-6. Digital inputs parameters

5.3.3 Analogue Input 1

Code	Parameter	Min	Max	Unit	Default	ID	Note
P2.3.3.1	AI1 signal selection	0.1	E.10		0.1	377	
P2.3.3.2	AI1 filter time	0,000	32,000	s	0,000	324	
P2.3.3.3	AI1 custom minimum setting	-160,00	160,00	%	0,00	321	
P2.3.3.4	AI1 custom maximum setting	-160,00	160,00	%	100,00	322	
P2.3.3.5	AI1 signal inversion	0	1		0	387	
P2.3.3.6	AI1 reference scaling, minimum value	-32000	32000		0	303	
P2.3.3.7	AI1 reference scaling, maximum value	-32000	32000		0	304	
P2.3.3.8	AI1 Controlled ID	0	10000		0	1507	

Table 5-7. ANALOG INPUT 1,

5.3.4 Analogue Input 2

Code	Parameter	Min	Max	Unit	Default	ID	Note
P2.3.4.1	AI2 signal selection	0.1	E.10		0.1	388	
P2.3.4.2	AI2 filter time	0,000	32,000	s	0,000	329	
P2.3.4.3	AI2 custom minimum setting	-160,00	160,00	%	0,00	326	
P2.3.4.4	AI2 custom maximum setting	-160,00	160,00	%	100,00	327	
P2.3.4.5	AI2 signal inversion	0	1		0	398	
P2.3.4.6	AI2 reference scaling, minimum value	-32000	32000		0	393	
P2.3.4.7	AI2 reference scaling, maximum value	-32000	32000		0	394	
P2.3.4.8	AI2 Controlled ID	0	10000		0	1511	

Table 5-8. ANALOG INPUT 2,

5.3.5 Analogue Input 3

Code	Parameter	Min	Max	Unit	Default	ID	Note
P2.3.5.1	AI3 signal selection	0.1	E.10		0.1	141	
P2.3.5.2	AI3 filter time	0,000	32,000	s	0,000	142	
P2.3.5.3	AI3 custom minimum setting	-160,00	160,00	%	0,00	144	
P2.3.5.4	AI3 custom maximum setting	-160,00	160,00	%	100,00	145	
P2.3.5.5	AI3 signal inversion	0	1		0	151	
P2.3.5.6	AI3 reference scaling, minimum value	-32000	32000		0	1037	
P2.3.5.7	AI3 reference scaling, maximum value	-32000	32000		0	1038	
P2.3.5.8	AI3 Controlled ID	0	10000		0	1509	

Table 5-9. ANALOG INPUT 3,

5.3.6 Analogue Input 4

Code	Parameter	Min	Max	Unit	Default	ID	Note
P2.3.6.1	AI4 signal selection	0.1	E.10		0.1	152	
P2.3.6.2	AI4 filter time	0,000	32,000	s	0,000	153	
P2.3.6.3	AI4 custom minimum setting	-160,00	160,00	%	0,00	155	
P2.3.6.4	AI4 custom maximum setting	-160,00	160,00	%	100,00	156	
P2.3.6.5	AI4 signal inversion	0	1		0	162	
P2.3.6.6	AI4 reference scaling, minimum value	-32000	32000		0	1039	
P2.3.6.7	AI4 reference scaling, maximum value	-32000	32000		0	1040	
P2.3.6.8	AI4 Controlled ID	0	10000		0	1510	

Table 5-10. ANALOG INPUT 4,

5.4 Output signals

5.4.1 Digital Outputs

Code	Parameter	Min	Max	Unit	Default	ID	Description
2.4.1.1	Ready	0.1	E.10	DiOut		432	
2.4.1.2	Running	0.1	E.10	DiOut		433	
2.4.1.3	Fault	0.1	E.10	DiOut		434	
2.4.1.4	Fault, Inverted	0.1	E.10	DiOut		435	
2.4.1.5	Warning	0.1	E.10	DiOut		436	
2.4.1.6	FB Dig Input 1	0.1	E.10	DiOut		455	
2.4.1.7	FB DIN 1 Par ID	0.1	E.10	DiOut		891	
2.4.1.8	FB Dig Input 2	0.1	E.10	DiOut		456	
2.4.1.9	FB DIN 2 Par ID	0.1	E.10	DiOut		892	
2.4.1.10	FB Dig Input 3	0.1	E.10	DiOut		457	
2.4.1.11	FB DIN 3 Par ID	0.1	E.10	DiOut		893	
2.4.1.12	FB Dig Input 4	0.1	E.10	DiOut		169	
2.4.1.13	FB DIN 4 Par ID	0.1	E.10	DiOut		894	
2.4.1.14	Charge DC	0.1	E.10	DiOut		1668	
2.4.1.15	DC Ready	0.1	E.10	DiOut		1218	
2.4.1.16	Charging	0.1	E.10	DiOut		1219	
2.4.1.17	Discharging	0.1	E.10	DiOut		1220	

Table 5-11. Digital outputs parameters

5.4.2 Analogue Output 1

Code	Parameter	Min	Max	Unit	Default	ID	Description
P2.4.2.1	lout 1 Signal	0.1	E.10	AnOUT	0.1	464	
P2.4.2.2	lout 1 Content	0	8		0	307	0 = 4 mA 1 =±2*Active Current 2 =Source Voltage 3 =Measured Source Voltage 4 =DC Voltage Unfiltered 5 =DC Current 6 = Power 7 =FB Analogue Input ID48 8 =Value Control Output
P2.4.2.3	lout 1 Filter Time	0	10	s		308	
P2.4.2.4	lout 1 Invert	0	1			309	
P2.4.2.5	lout 1 Minimum	0	1			310	
P2.4.2.6	lout 1 Scale	10	1000	%		311	
P2.4.2.7	lout 1 Offset	-100	100	%		375	

Table 5-12. Analogue Output 1 parameters

5.4.3 Analogue Output 2

Code	Parameter	Min	Max	Unit	Default	ID	Description
P2.4.3.1	lout 2 Signal	0.1	E.10	AnOUT		471	
P2.4.3.2	lout 2 Content	0	8		0	472	See P2.4.2.2
P2.4.3.3	lout 2 Filter Time	0	10	s		473	
P2.4.3.4	lout 2 Invert	0	1			474	
P2.4.3.5	lout 2 Minimum	0	1			475	
P2.4.3.6	lout 2 Scale	10	1000	%		476	
P2.4.3.7	lout 2 Offset	-100	100	%		477	

Table 5-13. Analogue Output 2 parameters

5.4.4 Delayed Digital Output 1

Code	Parameter	Min	Max	Unit	Default	Cust	ID	Note
P2.4.4.1	Digital output 1 signal selection	0.1	E.10		0.1		486	Possibility to invert by ID1808 Output Inversion
P2.4.4.2	Digital output 1 function	0	10		0		312	0=Not used 1=Ready 2=Run 3=Fault 4=Fault inverted 5=Warning 6=Therm. fault or warn. 7=Fieldbus input data 1 8=Fieldbus input data 2 9=Fieldbus input data 3 10=ID.Bit Select
P2.4.4.3	Digital output 1 on delay	0.00	320.00	s	0.00		487	0.00 = On delay not in use
P2.4.4.4	Digital output 1 off delay	0.00	320.00	s	0.00		488	0.00 = Off delay not in use
P2.4.4.5	ID.Bit Free DO	0.00	2000.15		0.00		1217	

5.4.5 Delayed Digital Output 2

Code	Parameter	Min	Max	Unit	Default	Cust	ID	Note
P2.4.5.1	Digital output 2 signal selection	0.1	E.10		0.1		489	Possibility to invert by ID1808 Output Inversion
P2.4.5.2	Digital output 2 function	0	28		0		490	See P2.4.4.2
P2.4.5.3	Digital output 2 on delay	0.00	320.00	s	0.00		491	0.00 = On delay not in use
P2.4.5.4	Digital output 2 off delay	0.00	320.00	s	0.00		492	0.00 = Off delay not in use
P2.4.5.5	ID.Bit Free DO	0.00	2000.15		0.00		1385	

5.4.6 Output Options

Code	Parameter	Min	Max	Unit	Default	Cust	ID	Note
P2.4.6.1	Output Inversion	0	65535		0		1808	

5.5 Limit Settings

5.5.1 Current Limit

Code	Parameter	Min	Max	Unit	Default	ID	Note
P2.5.1.1	Current Limit	0	Varies	A	Varies	107	Total current limit
P2.5.1.2	Charging Limit	0	300	%	105	1290	% of Source Nom Current
P2.5.1.2	Discharge Limit	0	300	%	105	1289	% of Source Nom Current

Table 5-14. Current limit parameters

5.5.2 Under Voltage Control for DC-Link Voltage

Code	Parameter	Min	Max	Unit	Default	ID	Note
P2.5.2.1	Under Voltage Reference	0	320	%	65	1567	% of unit nominal DC-Link voltage. 500 Vac unit: 675 Vdc 690 Vac unit: 931 Vdc
P2.5.2.2	Under Voltage Droop	0	100	%	0	1863	
P2.5.2.3	Under Voltage Kp	0	32000		50	1468	
P2.5.2.4	Under Voltage Ti	0	32000		15	1409	
P2.5.2.5	Under Voltage Kp Add	0	32000		50	1425	
P2.5.2.6	LK Low DC	0	65535		0	1813	

Table 5-15. Under voltage control parameters

5.5.3 Over Voltage Control for DC-Link Voltage

Code	Parameter	Min	Max	Unit	Default	ID	Note
P2.5.2.1	Over Voltage Reference	0	320	%	118	1528	% of unit nominal DC-Link voltage. 500 Vac unit: 675 Vdc 690 Vac unit: 931 Vdc
P2.5.2.2	Over Voltage Droop	0	100	%	0	1862	
P2.5.2.3	Over Voltage Kp	0	32000		50	699	
P2.5.2.4	Over Voltage Ti	0	32000		15	698	
P2.5.2.5	Over Voltage Kp Add	0	32000		50	697	

Table 5-16. Over voltage control parameters

5.5.4 Source Voltage

Code	Parameter	Min	Max	Unit	Default	ID	Note
P2.5.4.1	Source Min Voltage	50,0	1100,0	Vdc	200/345	1893	Discharge limit
P2.5.4.2	Source Max Voltage	50,0	1100,0	Vdc	749/1099	1895	Charge limit
P2.5.4.3	Source Voltage Hysteresis	0,0	100,0	Vdc	5,0	1896	

Table 5-17. Source voltage parameters

5.6 DC Control Parameters

Code	Parameter	Min	Max	Unit	Default	ID	Description
P2.6.1	DC Control Mode	0	1		0	600	0=Open Loop 1=Closed Loop

Table 5-18. DC control parameters

5.6.1 Inner control

Code	Parameter	Min	Max	Unit	Default	ID	Description
P2.6.2.1	Current Control Kp	1,00	320,00	%	20,00	617	
P2.6.2.2	Current Control Ti	0,1	3200,0	ms	1,5	657	
P2.6.2.3	Voltage Control Kp	1	32000		200	1870	
P2.6.2.4	Voltage Control Ti	1	32000		50	1871	

Table 5-19. Inner control loop parameters

5.6.2 Closed Loop

Code	Parameter	Min	Max	Unit	Default	ID	Description
P2.6.3.1	DC Control Kp	0,00	2000	%	100,00	613	
P2.6.3.2	DC Control Ti	0	10000	ms	1000	614	
P2.6.3.3	DC PI Max Adjust	0,00	20	%	5,00	1906	Also trip limit.
P2.6.3.5	Closed Loop Feedback loss response	0	2		2	752	0=No response 1=Warning 2=Fault

Table 5-20. Closed Loop control loop parameters

5.6.3 Voltage Feedback Signal

Code	Parameter	Min	Max	Unit	Default	ID	Description
P2.6.4.1	Feedback AnIN	0.1	E.10	AnIN	0.1	1595	
P2.6.4.2	Feedback Filter TC	0	1000	ms	3	618	
P2.6.4.3	Nom Vdc Signal Level	0,00	320,00	%	90,00	337	
P2.6.4.4	Zero Vdc Signal Level	-320,00	320,00	%	20,00	320	

Table 5-21. Voltage feedback signal parameters

5.7 Drive Control parameters

Code	Parameter	Min	Max	Unit	Default	ID	Description
P2.7.1	Switching frequency	3,6	Varies	kHz	5,0	601	Switching frequency
P2.7.2	Control Options 1	0	65535		0	1707	
P2.7.3	DC/DC Options	0	65535		0	1463	

Table5-22. Drive control parameters

5.7.1 Identification

Code	Parameter	Min	Max	Unit	Default	ID	Description
2.7.4.1	IU Offset	-32000	32000		10000	668	
2.7.4.2	IV Offset	-32000	32000		0	669	
2.7.4.3	IW Offset	-32000	32000		0	670	
2.7.4.4	Charge Resistance	0	10000		1	662	
2.7.4.5	Discharge Resistance	0	10000		1	665	
2.7.4.6	DCLinkMeasCalib	-2,00	2,00	%	0,00	549	

Table5-23. Identification parameters

5.7.2 System Test (Internal)

Code	Parameter	Min	Max	Unit	Default	ID	Description
2.7.5.1	Modulation Limit	0	250		100	1515	
2.7.5.2	Advanced Options 1	0	65535		0	1560	
2.7.5.3	Advanced Options 2	0	65535		0	1561	
2.7.5.4	Inverse Synch	0	1		0	1857	
2.7.5.5	DC Ripple Compensation Kp	0	1000		0	1897	
2.7.5.6	DC Ripple Compensation Phase	-360	360		0	1898	
2.7.5.7	DC Ripple Compensation Frequency	0	1000	Hz	300	1899	

Table5-24. System Test parameters

5.7.3 Battery Emulator/Simulator

Code	Parameter	Min	Max	Unit	Default	ID	Description
P 2.7.6.1	Emulator Mode				0	3501	0 = off 1 = Emulator mode 2 = Simulation mode 3 = Parallel Simulation mode
P 2.7.6.2	Model A			%	10,00	3502	
P 2.7.6.3	Model B			%	1500	3503	
P 2.7.6.4	Model K			%	4,00	3504	
P 2.7.6.5	Model Q			%	130,00	3505	
P 2.7.6.6	Model Qnomh			%	100	3506	
P 2.7.6.7	Model R			%	2,00	3507	
P 2.7.6.8	Model Set SoC			%	90,00	3508	
V 2.7.6.9	Model Voltage			%		3509	
V 2.7.6.10	Model SoC			%		3510	

Table5-25. Battery Emulator/Simulator parameters

5.8 Master-Follower Parameters

Code	Parameter	Min	Max	Unit	Default	ID	Description
P2.8.1	MF Mode	0	2		0	1324	
P2.8.2	SB Comm. Fault	0	2		2	1082	
P2.8.3	SB Fault Delay	0,00	10,00		0,50	1352	
P2.8.4	Synch. Fault Response	0	2		1	1701	
P2.8.5	Follower fault	0	2		1	1536	

Table 5-23. Master-Follower parameters

5.9 Fieldbus parameters

Code	Parameter	Min	Max	Unit	Default	ID	Description
P2.9.1	FB Actual Selection	0	10000		1125	1853	Choose monitoring data with parameter ID
P2.9.2	GSW ID	0	10000		0	897	
P2.9.3	Fieldbus data out 1 selection	0	10000		0	852	
P2.9.4	Fieldbus data out 2 selection	0	10000		0	853	
P2.9.5	Fieldbus data out 3 selection	0	10000		0	854	
P2.9.6	Fieldbus data out 4 selection	0	10000		0	855	
P2.9.7	Fieldbus data out 5 selection	0	10000		0	856	
P2.9.8	Fieldbus data out 6 selection	0	10000		0	857	
P2.9.9	Fieldbus data out 7 selection	0	10000		0	858	
P2.9.10	Fieldbus data out 8 selection	0	10000		0	859	
P2.9.11	Fieldbus data out 9 selection	0	10000		0	558	Visible with correct hardware and software
P2.9.12	Fieldbus data out 10 selection	0	10000		0	559	Visible with correct hardware and software
P2.9.13	Fieldbus data out 11 selection	0	10000		0	560	Visible with correct hardware and software
P2.9.14	Fieldbus data out 12 selection	0	10000		0	561	Visible with correct hardware and software
P2.9.15	Fieldbus data out 13 selection	0	10000		0	562	Visible with correct hardware and software
P2.9.16	Fieldbus data out 14 selection	0	10000		0	563	Visible with correct hardware and software
P2.9.17	Fieldbus data out 15 selection	0	10000		0	564	Visible with correct hardware and software
P2.9.18	Fieldbus data out 16 selection	0	10000		0	565	Visible with correct hardware and software
P2.9.19	FB Reference Selector	0	10000		0	1850	Choose controlled data with parameter ID
P2.9.20	Fieldbus data in 1 selection	0	10000		0	876	
P2.9.21	Fieldbus data in 2 selection	0	10000		0	877	
P2.9.22	Fieldbus data in 3 selection	0	10000		0	878	
P2.9.23	Fieldbus data in 4 selection	0	10000		0	879	
P2.9.24	Fieldbus data in 5 selection	0	10000		0	880	
P2.9.25	Fieldbus data in 6 selection	0	10000		0	881	
P2.9.26	Fieldbus data in 7 selection	0	10000		0	882	
P2.9.27	Fieldbus data in 8 selection	0	10000		0	883	
P2.9.28	Fieldbus data in 9 selection	0	10000		0	550	Visible with correct hardware and software
P2.9.29	Fieldbus data in 10 selection	0	10000		0	551	Visible with correct hardware and software
P2.9.30	Fieldbus data in 11 selection	0	10000		0	552	Visible with correct hardware and software
P2.9.31	Fieldbus data in 12 selection	0	10000		0	553	Visible with correct hardware and software

Code	Parameter	Min	Max	Unit	Default	ID	Description
P2.9.32	Fieldbus data in 13 selection	0	10000		0	554	Visible with correct hardware and software
P2.9.33	Fieldbus data in 14 selection	0	10000		0	555	Visible with correct hardware and software
P2.9.34	Fieldbus data in 15 selection	0	10000		0	556	Visible with correct hardware and software
P2.9.35	Fieldbus data in 16 selection	0	10000		0	557	Visible with correct hardware and software
P2.9.36	Control Slot Selector	0	Varies		0	1440	<p>0=Not sel., 4=Slot D, 5=Slot E, 6=Slot D Fast, 7=Slot E Fast, 8=Slot D 16, 9=Slot E 16</p> <p>Note: 6-9 visible with correct hardware and software.</p>
P2.9.37	State Machine	0	1		0	896	

Table 5-24. Fieldbus parameters

5.10 Protections (Control keypad:

5.10.1 General

Code	Parameter	Min	Max	Unit	Default	ID	Description
P2.10.1.1	Response to external fault 1	0	3		2	701	0=No response 1=Warning 2=Fault
P2.10.1.2	Max Charge Time	0,00	10,00	s	5,00	1522	Charging time limit when drive charging options are used.
P2.10.1.3	Response to 4mA reference fault	0	5		0	700	0=No response 1=Warning 2=Fault
P2.10.1.4	FaultWarnIndicat	0	2		1	1940	0=Static 1=Toggle 2=Marine

Table 5-25. Protections parameters

5.10.2 Temperature sensors

Code	Parameter	Min	Max	Unit	Default	ID	Description
P2.10.2.1	No. of used inputs on board 1	0	5		0	739	0=Not used (ID Write) 1 = Sensor 1 in use 2 = Sensor 1 & 2 in use 3 = Sensor 1 & 2 & 3 in use 4 = Sensor 2 & 3 in use 5 = Sensor 3 in use
P2.10.2.2	Response to temperature fault	0	2		2	740	0=No response 1=Warning 2=Fault
P2.10.2.3	Board 1 warning limit	-30,0	200,0	C°	120,0	741	
P2.10.2.4	Board 1 fault limit	-30,0	200,0	C°	130,0	742	

Table 5-26. Protections parameters

5.10.3 Thermal Protection

Code	Parameter	Min	Max	Unit	Default	ID	Description
P2.10.3.1	Response to temperature fault	0	3		2	740	
P2.10.3.2	Thermal Fault Delay	0	1800	s	0	707	

Table 5-27. Thermal protection

5.10.4 Fieldbus protection

Code	Parameter	Min	Max	Unit	Default	ID	Description
P2.10.4.1	FB Communication Response	0	2		2	733	
P2.10.4.2	FB WD Delay	0,00	30,00	S	0,00	1354	0,00 = Disabled

Table 5-28. Fieldbus protection

5.10.5 Protection

Code	Parameter	Min	Max	Unit	Default	ID	Description
P2.10.5	Fault Simulation	0	65535		0	1569	
P2.10.6	Reset Data Logger	0	1		0	1849	

Table 5-29. Protections parameters

5.11 ID Control Functions

5.11.1 Value Control

Code	Parameter	Min	Max	Unit	Default	Cust	ID	Note
P2.11.1.1	Control Mode	0	5		0		1586	0=SR ABS 1=Scale ABS 2=Scale INV ABS 3=SR 4=Scale 5=Scale INV 6=XY-Control
P2.11.1.2	Control Input Signal ID	0	10000	ID	0		1580	
P2.11.1.3	Control Input Off Limit	-32000	32000		0		1581	
P2.11.1.4	Control Input On Limit	-32000	32000		0		1582	
P2.11.1.5	Control Output Off Value	-32000	32000		0		1583	
P2.11.1.6	Control Output On Value	-32000	32000		0		1584	
P2.11.1.7	Control Output Signal ID	0	10000	ID	0		1585	
P2.11.1.8	Control Output Filtering time	0,000	32,000	s	0,000		1721	
P2.11.1.9	X Value 01	-32000	32000		0		1626	
P2.11.1.10	Y Value 01	-32000	32000		0		2001	
P2.11.1.11	X Value 02	-32000	32000		0		1627	
P2.11.1.12	Y Value 02	-32000	32000		0		2002	
P2.11.1.13	X Value 03	-32000	32000		0		1628	
P2.11.1.14	Y Value 03	-32000	32000		0		2003	
P2.11.1.15	X Value 04	-32000	32000		0		1629	
P2.11.1.16	Y Value 04	-32000	32000		0		2004	
P2.11.1.17	X Value 05	-32000	32000		0		1630	
P2.11.1.18	Y Value 05	-32000	32000		0		2005	
P2.11.1.19	X Value 06	-32000	32000		0		1631	
P2.11.1.20	Y Value 06	-32000	32000		0		2006	

Table 5-30. Power reference input signal selection

5.11.2 DIN ID Control 1

Code	Parameter	Min	Max	Unit	Default	Cust	ID	Note
P2.11.2.1	ID Control DIN	0.1	E.10		0.1		1570	Slot . Board input No.
P2.11.2.2	Controlled ID	0	10000	ID	0		1571	Select ID that is controlled by digital input
P2.11.2.3	False value	-32000	32000		0		1572	Value when DI is low
P2.11.2.4	True value	-32000	32000		0		1573	Value when DI is high

Table 5-31. DIN ID Control parameters

5.11.3 DIN ID Control 2

Code	Parameter	Min	Max	Unit	Default	Cust	ID	Note
P2.11.3.1	ID Control DIN	0.1	E.10		0.1		1590	Slot . Board input No.
P2.11.3.2	Controlled ID	0	10000	ID	0		1575	Select ID that is controlled by digital input
P2.11.3.3	False value	-32000	32000		0		1592	Value when DI is low
P2.11.3.4	True value	-32000	32000		0		1593	Value when DI is high

Table 5-32. DIN ID Control parameters

5.11.4 DIN ID Control 3

Code	Parameter	Min	Max	Unit	Default	Cust	ID	Note
P2.11.4.1	ID Control DIN	0.1	E.10		0.1		1578	Slot . Board input No.
P2.11.4.2	Controlled ID	0	10000	ID	0		1579	Select ID that is controlled by digital input
P2.11.4.3	False value	-32000	32000		0		1594	Value when DI is low
P2.11.4.4	True value	-32000	32000		0		1596	Value when DI is high

Table 5-33. DIN ID Control parameters

5.12 Keypad control (Control keypad: Menu M3)

Code	Parameter	Min	Max	Unit	Default	ID	Description
P3.1	Control place	1	3		2	125	0=PC Control 1=I/O terminal 2=Keypad (Default) 3= Fieldbus
P3.2	License Key	0	0	65535		1995	

Table 5-34. Keypad control parameters M3

5.13 System menu (Control keypad: Menu M6)

For parameters and functions related to the general use of the frequency converter, such as application and language selection, customised parameter sets or information about the hardware and software, see Chapter 7.3.6 in the Vacon NX User's Manual.

5.14 Expander boards (Control keypad: Menu M7)

The **M7** menu shows the expander and option boards attached to the control board and board-related information. For more information, see Chapter 7.3.7 in the Vacon NX User's Manual and Vacon I/O option board manual.

6. DESCRIPTION OF PARAMETERS

6.1 Basic parameters

P2.1.1 Source Nom Current ID113

This parameter defines current value that is used as 100 % current for e.g. charging current limit.

P2.1.2 Source Nom Voltage ID110

This parameter defines absolute voltage value that is used as 100 % voltage for e.g. voltage reference. Minimum nominal source voltage is 50 Vdc

P2.1.3 Source Nom Power ID116

This parameter is used for scaling percentage power monitoring value and analogue output signals. When left zero drive uses nominal power based on Source Nom Current and Source Nom Voltage.

P2.1.4 Control Mode ID1858

Selection if drive is current, voltage or power controlled mode.

0 = Current control mode

1 = Voltage control mode

Cascade voltage control. Use in combination of P2.7.3 to activate direct voltage control.

2 = Power control mode (current reference is computed internally based on the source voltage)

P2.1.5 Voltage Reference ID1462

Voltage reference in percentage of Source Nom Voltage.

P2.1.6 Current Reference ID1860

Active current reference of the drive in percentage of Source Nominal Current parameter.

Active Curr. Ref > 0: Current flow from Drive DC-Link to Source.

Active Curr. Ref < 0: Current flow from Source to Drive DC-Link.

P2.1.6 Power Reference ID1869

Power reference of the drive in per cent. 100,0 % equals 100.0 % Active Current and 100.0 % Source Voltage.

Power Reference > 0: Current flow from Drive DC-Link to Source.

Power Reference < 0: Current flow from Source to Drive DC-Link.

P2.1.7 Identification ID631

Identification function will calibrate current measurement.

0 = No Action

1 = Current measurement offset

During identification drive needs to be connected to battery system (or the used DC power source) and DC-Link voltage needs to be higher than the battery voltage so that there is no power flow from batteries to DC-link.

Select identification run and give DC/DC converter start command within 20 second after identification mode is selected.

6.2 Reference Handling

P2.2.1 IO Control Mode ID1856

This parameter is used to select different control mode for IO control than the common control mode selection parameter P2.1.4

0 = Control Mode P2.1.4

IO Control place operation mode defined by ID1858 (P2.1.4) parameter

1 = Current control mode

When control place is IO, control mode is Current Control.

2 = Voltage control mode

When control place is IO, control mode is Voltage Control.

3 = Power control mode

When control place is IO, control mode is Power Control.

P2.2.2 IO Voltage Ref Sel. ID117

0 = Voltage Ref. ID1462

1 = FB Voltage Ref. ID875

P2.2.3 IO Current Ref. Sel. ID131

0 = Current Ref. ID1860

1 = FB Current Ref. ID1140

P2.2.4 IO Power Ref. Sel. ID1620

0 = Power Ref. ID1869

1 = FB Power Ref. ID1141

P2.2.5 FB Control Mode ID1848

When using forced control place this parameter can be used change control mode.

0 = Control Mode P2.1.4

FB Control place operation mode defined by ID1858 (P2.1.4) parameter

1 = Current control mode

When control place is FB, control mode is Current Control.

2 = Voltage control mode

When control place is FB, control mode is Voltage Control.

3 = Power control mode

When control place is IO, control mode is Power Control.

P2.2.6 FB Voltage Ref Sel. ID112

0 = Voltage Ref. ID1462

1 = FB Voltage Ref. ID875

P2.2.7 FB Current Ref. Sel. ID641

0 = Current Ref. ID1860

1 = FB Current Ref. ID1140

P2.2.8 FB Power Ref. Sel. ID1621

0 = Power Ref. ID1869

1 = FB Power Ref. ID1141

6.2.1 Voltage reference handling

P2.2.9.1 Drooping ID620

Drooping for Source DC Voltage. Used when parallel DC/DC converters are used.

P2.2.9.2 Voltage Reference Ramp Rate ID1867

Voltage reference ramp rate in %/s. Values below zero means no ramp in voltage reference.

P2.2.9.3 Direct Vdc Control ID1743

Direct voltage control when voltage control mode selected.

Controls duty cycle of the converter directly instead of cascade control used in the standard voltage control mode. Use this control mode for DC-power supply applications where robustness against load steps is required.

0 = No, normal cascade control

1 = Yes, Direct voltage control

6.2.2 Current reference handling

6.2.2.1 Constant Current Reference

Constant Current references, activated by digital input will also start the drive directly to the set reference. If other start commands are active, the constant references is not activated. If control mode is voltage by default, then it's recommend to use same input to change to control mode to current as is used from Enable Constant Current Reference.

P2.2.10.1 Constant Reference 1 ID1239

Constant reference 1 activated by ID530 and ID532.

P2.2.10.2 Constant Reference 2 ID1240

Constant reference 2 activated by ID530 and ID531.

P2.2.10.3.1 Phase Reference Mode ID1859

Select if same current reference is used for all phases or current is controlled individually.

0 = Average

P2.2.4.1 Current Reference is used to control average current.

1 = Individual phase control

Each phase is controlled separately with G2.2.4.4 parameters.
Used when each phase have separate DC source.

2 = Same

P2.2.4.1 Current Reference is used to control every phase current to be same.

P2.2.10.3.2 IU Current Reference ID128

U phase current reference on individual mode.

P2.2.10.3.3 IV Current Reference ID129

V phase current reference on individual mode.

P2.2.10.3.4IW Current Reference ID130

W phase current reference on individual mode.

6.2.3 Start Reference Handling

P2.2.11.1 Voltage Reference At Start ID1864

This parameter is used to define how the voltage reference starting value is handled in a start. The start will be smoother when the value is close to the actual source voltage.

0 = Reference

Starting voltage is directly given reference P2.2.1.1 Voltage Reference.

1 = V Ref Start

Starting voltage is defined by parameter P2.2.1.5 Start Voltage Reference and ramped to actual reference with set ramp rate.

2 = Measurement

Starting voltage is taken from measured voltage V1.12.11 Voltage Meas. ID1866.
This monitoring value can be written by analogue ID function or from fieldbus.

3 = 80 %

Drive will start as initial guess of 80 % of source voltage.

P2.2.11.2 Start Voltage Reference ID1865

Voltage value that is used for initial start voltage when P2.2.1.4 Voltage Reference At Start is 1 / V Ref Start.

6.3 Input Signals

6.3.1 Basic Settings

P2.3.1.1 Start/Stop Logic Selection ID300

This parameter defines the start/stop logic when using I/O control.

0 Start – No Act – Start Drive – No Action

Start 1: closed contact = start command DI “Start 1”

1 StartP-StopP – Start Pulse – Stop Pulse

3-wire connection (pulse control):

DIN1: closed contact = start pulse

DIN2: open contact = stop pulse, falling edge.

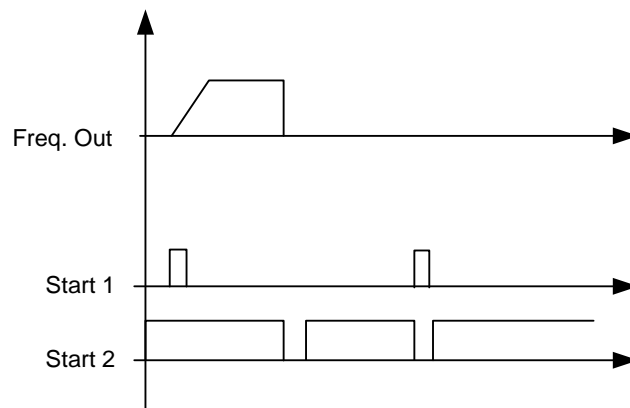

Figure 1. Start pulse/ Stop pulse.

The selections including the text *Rising edge required to start* is be used to exclude the possibility of an unintentional start when, for example, power is connected, re-connected after a power failure, after a fault reset, after the drive is stopped by Run Enable (Run Enable = False) or when the control place is changed. The Start/Stop contact must be opened before the motor can be started.

2 RPuls – RPuls – Rising pulse start – Rising pulse stop

Start 1: closed contact = Start command DI “Start 1”

Start 2: closed contact = Stop command DI “Start 1”

6.3.2 Digital Inputs

- P2.3.2.1 Start Signal 1 ID403**
Signal selection 1 for the start/stop logic. This parameter is used to select the input for Run Request signal.
- P2.3.2.2 Start Signal 2 ID404**
Signal selection 1 for the start/stop logic. This parameter is used to select the input for Stop Request signal.
- P2.3.2.3 Run Enable ID407**
When the signal is low, the drive will lose READY status.

Contact open: the start of drive disabled.
Contact closed: the start of drive enabled.
- P2.3.2.4 Fault Reset ID414**
Contact closed: all faults are reset. Rising edge will reset faults.
- P2.3.2.5 External fault 1 ID405**
Contact Closed: the fault is displayed and the drive stopped. Fault 51.
- P2.3.2.6 External fault 2 ID406**
Contact open: the fault is displayed and the drive stopped. Fault 51.
- P2.3.2.7 Enable Constant Ref ID532**
Digital input to enable constant reference operation. When reference digital input is given drive will also start.
- P2.3.2.8 Constant Ref. 1 ID530**
Activates constant reference 1 if constant reference function is enabled by digital input.
Note: Will start the drive without separate start command.
- P2.3.2.9 Constant Ref. 2 ID531**
Activates constant reference 2 if constant reference function is enabled by digital input.
Note: Will start the drive without separate start command.
- P2.3.2.10 I/O Term Control ID409**
Forces Control place to IO.
- P2.3.2.11 Keypad Control ID410**
Forces Control place to keypad.
- P2.3.2.12 Fieldbus Control ID411**
Forces control place to fieldbus.
- P2.3.2.13 DC CB State ID1453**
Feedback from DC circuit breaker.
- P2.3.2.14 Thermal Switch ID1179**
Digital input information from any temperature monitoring. Low signal will make selected response.

6.3.3 Analogue Inputs 1-4

2.3.3.1 AI1 signal selection ID377 “AI1 Signal Sel”

2.3.4.1 AI2 signal selection ID388 “AI2 Signal Sel”

Connect the AI1/AI2 signal to the analogue input of your choice with this parameter.

2.3.5.1 AI3 signal selection ID141 “AI3 Signal Sel”

2.3.6.1 AI4 signal selection ID152 “AI4 Signal Sel”

Connect the AI3/AI4 signal to the analogue input of your choice with this parameter. When analogue input selection parameter is set to 0.1 you can control analogue input monitoring variable from Fieldbus by assign process data input ID number to monitoring signal thus allowing making of scaling function in drive side to PLC input signals.

2.3.3.2 Analogue input 1 signal filtering time ID324 “AI1 Filter Time”

2.3.4.2 Analogue input 2 signal filtering time ID329 “AI2 Filter Time”

2.3.5.2 Analogue input 3 signal filtering time ID142 “AI3 Filter Time”

2.3.6.2 Analogue input 4 signal filtering time ID153 “AI3 Filter Time”

First order filtering is used for analogue inputs signals 3 and 4.

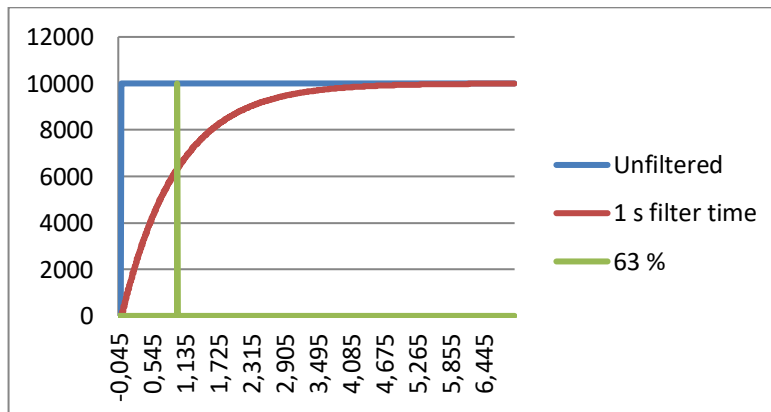

- 2.3.3.3** *AI1 custom setting minimum* ID321 “AI1 Custom Min”
- 2.3.3.4** *AI1 custom setting maximum* ID322 “AI1 Custom Max”
- 2.3.4.3** *AI2 custom setting minimum* ID326 “AI2 Custom Min”
- 2.3.4.4** *AI2 custom setting maximum* ID327 “AI2 Custom Max”
- 2.3.5.3** *AI3 custom setting minimum* ID144 “AI3 Custom Min”
- 2.3.5.4** *AI3 custom setting maximum* ID145 “AI3 Custom Max”
- 2.3.6.3** *AI4 custom setting minimum* ID155 “AI4 Custom Min”
- 2.3.6.4** *AI4 custom setting maximum* ID156 “AI4 Custom Max”

Set the custom minimum and maximum input levels for the AI3 signal within - 160...160%.

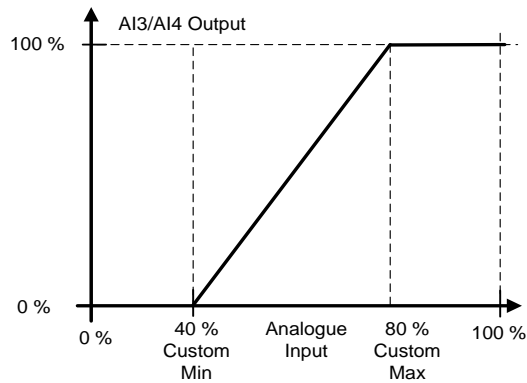

- 2.3.3.5 **AI1 signal inversion** ID387 “AI1 Signal Inv”
 2.3.4.5 **AI2 signal inversion** ID398 “AI2 Signal Inv”
 2.3.5.5 **AI3 signal inversion** ID151 “AI3 Signal Inv”
 2.3.6.5 **AI4 signal inversion** ID162 “AI3 Signal Inv”

Signal inversion function is useful in situation when e.g. PLC is sending power limit to the drive by using analogue inputs, if PLC is unable to communicate to the drive power limit would be normally zero, by using inverted signal logic zero value from PLC would mean maximum power limit thus allowing drive running e.g. from keypad without changing power limit function parameters.

0 = No inversion

1 = Signal inverted

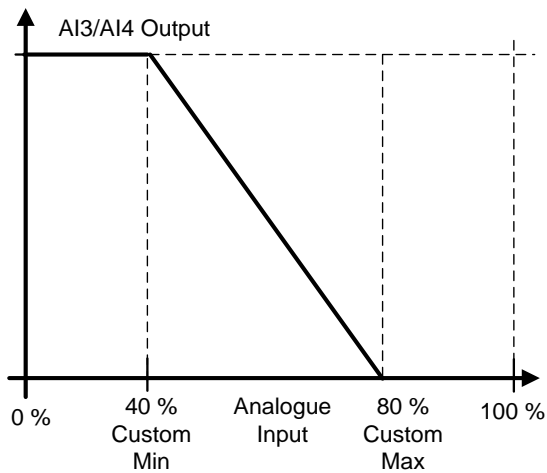

.6.3.3.1 Analogue input to any parameter

This function allows control of any parameter by using analogue input. with parameters it is selected what will be range of control area and ID number for paramter that is controller

- 2.3.3.6 Analogue input 1, minimum value ID303 "AI1 Scale Min"
- 2.3.3.7 Analogue input 1, maximum value ID304 "AI1 Scale Max"
- 2.3.4.6 Analogue input 2, minimum value ID393 "AI2 Scale Min"
- 2.3.4.7 Analogue input 2, maximum value ID394 "AI2 Scale Max"
- 2.3.5.6 Analogue input 3, minimum value ID1037 "AI3 Scale Min"
- 2.3.5.7 Analogue input 3, maximum value ID1038 "AI3 Scale Max"
- 2.3.6.6 Analogue input 4, minimum value ID1039 "AI4 Scale Min"
- 2.3.6.7 Analogue input 4, maximum value ID1040 "AI4 Scale Max"

These parameters are defining range for controlled parameter. All the values are considered to be integers thus when controlling FWP as in example you need to set also numbers for decimals. e.g. FWP 100,00 needs to be set as 10000.

- 2.3.3.8 AI1 Controlled ID ID1507 "AI1 Control. ID"
- 2.3.4.8 AI2 Controlled ID ID1511 "AI2 Control. ID"
- 2.3.5.8 AI3 Controlled ID ID1509 "AI3 Control. ID"
- 2.3.6.8 AI4 Controlled ID ID1510 "AI4 Control. ID"

These parameters define what controller parameter is.

Example:

You want to control motor field weakening point voltage by analogue input from 70,00 % to 130,00 %.

Set Scale min to 7000 = 70,00 %

Set Scale max to 13000 = 130,00 %

Set Controlled ID to 603 Voltage at filed weakening point

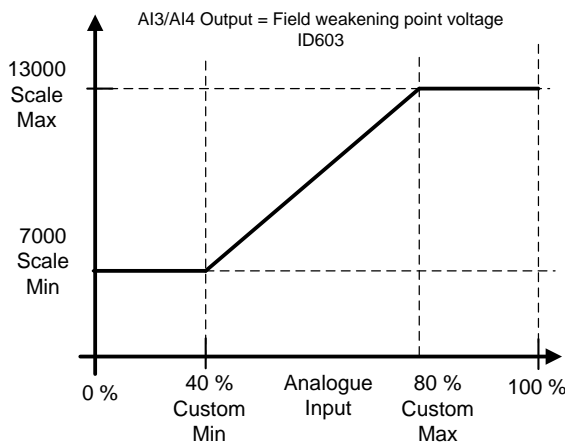

Now analogue input 3 signal 0 V to 10 V (0 mA to 20 mA) will control field weakening point voltage between 70,00 % - 130,00 %. When setting value, decimals are handled as integer.

6.4 Output Signals

6.4.1 Digital Outputs

2.4.1.1 **Ready** **ID432**

The DC/DC drive is ready to operate.

2.4.1.2 **Running** **ID433**

The DC/DC drive operates (the drive is modulating).

2.4.1.3 **Fault** **ID 434**

Drive is in fault state

2.4.1.4 **Fault, Inverted** **ID 435**

No active faults.

2.4.1.5 **Warning** **ID 436**

Warning situation is active

2.4.1.6 **Fieldbus input data 1** **ID455** **“FB Dig Input 1”**

2.4.1.8 **Fieldbus input data 2** **ID456** **“FB Dig Input 2”**

2.4.1.10 **Fieldbus input data 3** **ID457** **“FB Dig Input 3”**

2.4.1.12 **Fieldbus input data 4** **ID169** **“FB Dig Input 4”**

The data from the fieldbus main control word can be led to the digital outputs of the drive. See the fieldbus board manual for the location of these bits.

2.4.1.7 **FB DIN 1 Par ID** **ID 891**

2.4.1.9 **FB DIN 2 Par ID** **ID 892**

2.4.1.11 **FB DIN 3 Par ID** **ID 893**

2.4.1.13 **FB DIN 4 Par ID** **ID 894**

With these parameters you can define the parameter to be controlled by using FB digital input.

Example:

All option board inputs are already in use, but you want to give a DI: External Fault 1 (ID405) and drive has a fieldbus board.

Set parameter ID892 (Fieldbus Digital Input 2) to 405. Now you are able to control External Fault 1 command from the fieldbus by Profibus control word (bit 11).

It is possible to control any parameter in the same way if values 0 = FALSE and 1 = TRUE are significant for that parameter. For example, P2.1.5 Parallel AFE (ID1501) can be switched on and off using this function (Parallel AFE: 0 = No, 1 = Yes).

2.4.1.14 **Charge DC** **ID1668**

Digital output for DC-Link charge control.

2.4.1.15 **DC Ready** **ID1218**

DC-Link voltage is high enough to close the DC Breaker. If Source DC Voltage is monitored DC-Link voltage needs to be higher than Source DC Voltage.

2.4.1.16 Charging ID1219

Indication of direction of active current. When DO is high drive is charging the source more than a 0,5 %.

2.4.1.17 Discharging ID1220

Indication of direction of active current. When DO is high drive is discharging the source more than a 0,5 %.

6.4.2 Analogue Outputs 1 & 2

P2.4.2.1 *lout 1 Signal* **ID464**

P2.4.3.1 *lout 2 Signal* **ID471**

Connect the AO signal to the analogue output of your choice with this parameter.

P2.4.2.2 *lout 1 Content* **ID307**

P2.4.3.2 *lout 2 Content* **ID472**

0 = Not used

1 = ± 2 *Active Current

Bidirectional active current. Default scaling 50 %.

2 = Source Voltage

Estimated Source Voltage. Shows zero voltage when drive is not modulating.

3 = Measured Source Voltage

Shows V1.12.11 Voltage Meas. ID1866

4 = DC Voltage Unfiltered

500 Vdc unit scaling 1000 Vdc and 690 Vac unit 1317 Vdc

5 = DC Current

Bidirectional active current. Default scaling 50 %.

6 = Power

Bidirectional active current. Default scaling 50 %.

7 = FB Analogue Input ID48

8 = Value Control Output

P2.4.2.3 *lout 1 Filter Time* **ID308**

P2.4.3.3 *lout 2 Filter Time* **ID473**

Defines the filtering time of the analogue output signal. Setting this parameter value 0 will deactivate the filtering. First order filtering is used for the analogue output signals.

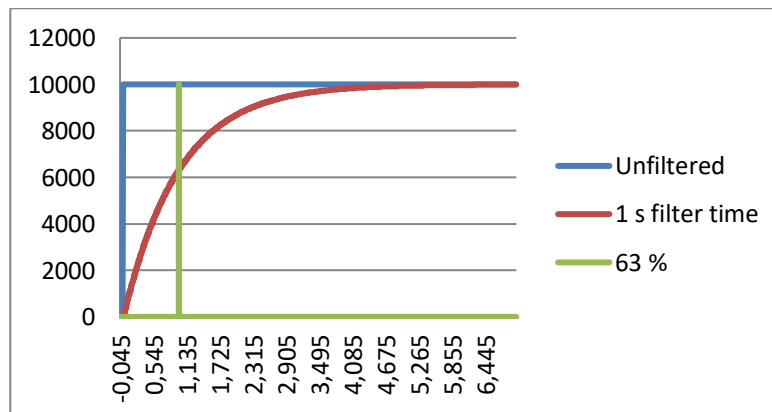

P2.4.2.4 Iout 1 Invert ID309**P2.4.3.4 Iout 2 Invert ID474**

Inverts the analogue output signal:

- Maximum output signal = Minimum set value.
- Minimum output signal = Maximum set value.

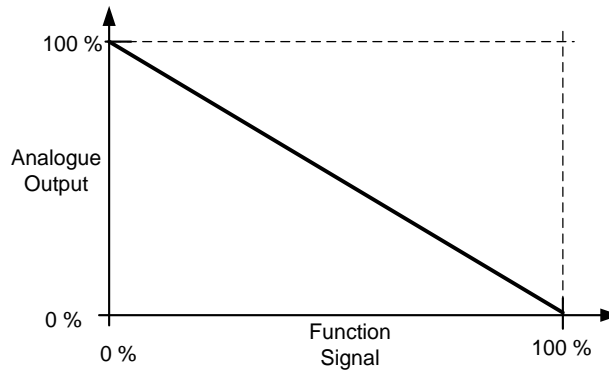
**P2.4.2.5 Iout 1 Minimum ID310****P2.4.3.5 Iout 2 Minimum ID475**

0 = Set minimum value to 0 mA (0%)

1 = Set minimum value to 4 mA (20%)

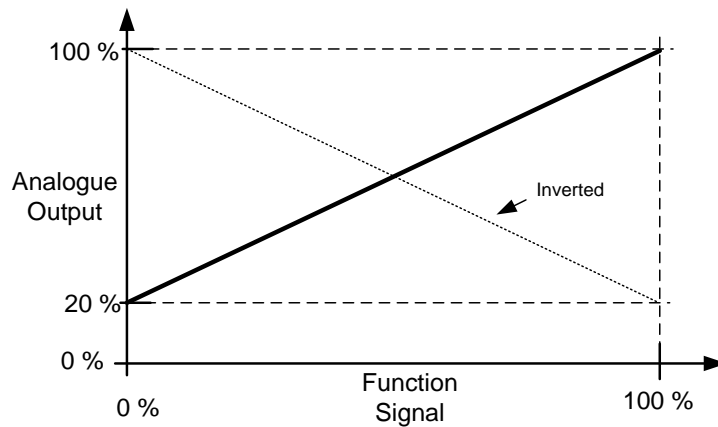

P2.4.2.6 *lout 1 Scale* **ID311**

P2.4.3.6 *lout 2 Scale* **ID476**

A scaling factor for an analogue output.

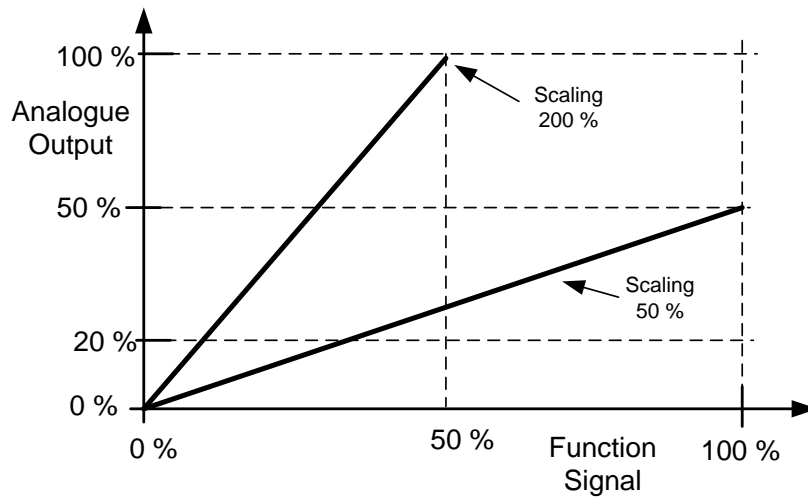

P2.4.2.7 *lout 1 Offset* **ID375**

P2.4.3.7 *lout 2 Offset* **ID477**

Add -100.0 to 100.0% to the analogue output.

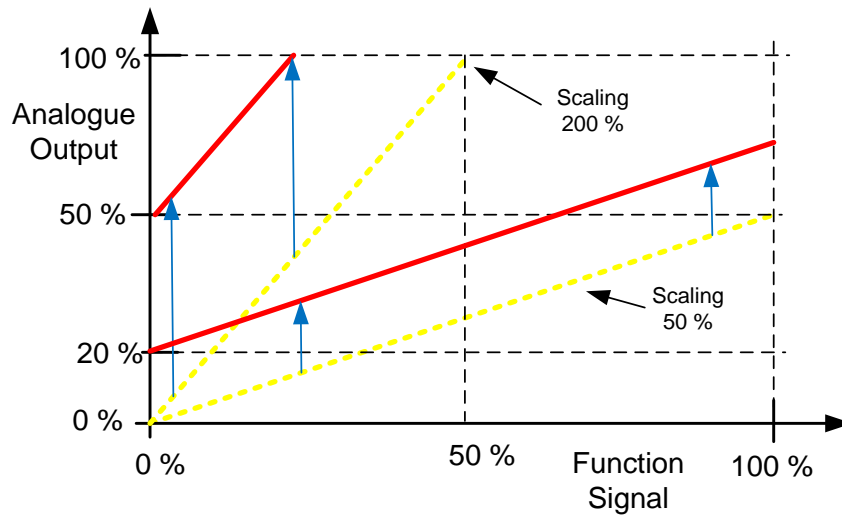

6.4.3 Delayed Digital Outputs 1 & 2

P2.4.4.1 Digital output 1 signal selection **ID486 “Dig.Out 1 Signal”**

P2.4.5.1 Digital output 2 signal selection **ID489 “Dig.Out 2 Signal”**

Connect the delayed digital output signal to the digital output of your choice with this parameter. For more information about the TTF programming method, see chapter **Error! Reference source not found..**

P2.4.4.2 Digital output function **ID312 “DO1 Content”**

P2.4.5.2 Digital output 2 function **ID490 “DO2 Content”**

0 = “Not used”

1 = “Ready”

The AC drive is ready to operate.

Common reasons when ‘Ready’ signals are missing:

- Run enable signal is low
- DC Voltage is too low
- DC Voltage is too high

2 = “Run”

The AC drive is modulating.

3 = “Fault”

A fault trip has occurred

4 = “FaultInvert”

No active faults in the drive.

5 = “Warning”

Always if a warning is on

6 = “ThermFlt/Wrn”

Thermistor fault or warning

The thermistor input of option board indicates overtemperature. Fault or warning depending on the response parameter.

7 = “FB DigInput1”

Fieldbus digital input data 1

8 = “FB DigInput2”

Fieldbus digital input data 2

9 = “FB DigInput3”

Fieldbus digital input data 3

10 = “ID.Bit”

Select the signal for controlling the DO. The parameter has to be set in format xxxx.yy where xxxx is the ID number of a signal and yy is the bit number. For example, the value for DO control is 1174.02. 1174 is the ID number of Warning Word 1. So the digital output is ON when bit number 02 of the warning word (ID no. 1174) i.e. Motor underload is high.

P2.4.4.3	Digital output 1 on-delay	ID487	“DO1 ON Delay”
P2.4.5.4	Digital output 1 off-delay	ID488	“DO1 OFF Delay”
P2.4.4.3	Digital output 2 on-delay	ID491	“DO2 ON Delay”
P2.4.5.4	Digital output 2 off-delay	ID492	“DO2 OFF Delay”

With these parameters you can set on- and off-delays to digital outputs.

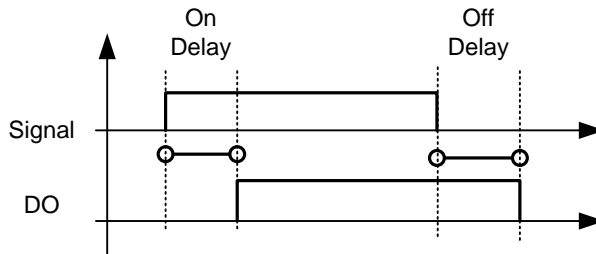

Figure 6-1. Digital outputs 1 and 2, on- and off-delays

P2.4.4.5	ID.Bit Free DO 1	ID1217
P2.4.5.5	ID.Bit Free DO 2	ID1385

Select the signal for controlling the DO. The parameter has to be set in format xxx.yy where xxx is the ID number of a signal and yy is the bit number. For example, the value for DO control is 1174.02. 1174 is the ID number of Warning Word 1. So the digital output is ON when bit number 02 of the warning word (ID no. 1174) i.e. *Motor underload* is high.

6.4.4 Output Options

P2.5.9.1	Output Inversion	ID1808
-----------------	-------------------------	---------------

Invert selected digital output functions.

B2 =+4= Invert Digital Output 1

B3 =+8= Invert Digital Output 2

6.5 Limit Settings

6.5.1 Current Limit

P2.5.1.1 Current Limit A ID107

Current limit in amps.

P2.5.1.2 Charging Limit % ID1290

Charging current limit in percentage of Source Nom Current

P2.5.1.2 Discharge Limit % ID1289

Discharging current limit in percentage of Source Nom Current

6.5.2 Under Voltage Control

Under voltage controller starts to feed DC-Link when limit is reached. Discharging is limited by discharge current limit and minimum source voltage limit.

P2.5.2.1 Under Voltage Reference ID1567

Under voltage reference, % of unit nominal DC Voltage.

P2.5.2.2 Under Voltage Droop ID1863

Under voltage reference drooping, set droop is reached when active current is 100 %.

P2.5.2.3 Under Voltage Kp ID1468

P2.5.2.4 Under Voltage Ti ID1409

P2.5.2.5 Under Voltage Kp Add ID1425

P2.5.2.6 Enable Black Start ID1813

This parameter enables low DC-Link ready level. Any value above zero will enable function. i.e. previous license codes will enable function even the license is no longer needed.

6.5.3 Over Voltage Controller

Over voltage controller starts to limit source current to the DC-Link when limit is reached when references makes drives to discharge. When DC-Link voltage rises to over voltage level from external power drive will starts to charge source, until charging current limit is reached or maximum source voltage.

P2.5.2.1 Over Voltage Reference ID1528

Over voltage reference, % of unit nominal DC Voltage.

P2.5.2.2 Over Voltage Droop ID1862

Under voltage reference drooping, set droop is reached when active current is 100 %.

P2.5.2.3 Over Voltage Kp ID699

P2.5.2.4 Over Voltage Ti ID698

P2.5.2.5 Over Voltage Kp Add ID697

6.5.4 Source Dc Voltage limits

P2.5.4.1 Source Min Voltage ID1893

If Source DC voltage reaches this minimum value discharging is disabled.

P2.5.4.2 Source Max Voltage ID1895

If Source DC voltage reaches this maximum value charging is disabled.

P2.5.4.3 Source Voltage Hysteresis ID1896

Hysteresis for limiting functions.

6.6 DC Control

P2.6.1 DC Control Mode ID600

0 = Open Loop

External feedbacks are not used for control,

1 = Closed Loop

Voltage feedback is used for voltage controller.

6.6.1 Inner Control Loop

Parameters for adjusting current and voltage controllers. No need to adjust unless recommended by factory.

P2.6.2.1 Current Control Kp ID617

This parameter sets the gain of the current PI controller in current controller mode.

P2.6.2.2 Current Control Ti ID657

This parameter sets the integration time constant of the current PI controller in current control mode.

P2.6.2.3 Voltage Control Kp ID1870

This parameter sets the gain for the PI voltage controller in voltage control mode.

P2.6.2.4 Voltage Control Ki ID1871

This parameter sets the integration time constant in ms of the PI controller in voltage control mode.

6.6.2 Closed Loop

Voltage controller loop using analogue input as feedback signal. PI controller will make correction to final voltage reference within allowed maximum adjust.

P2.6.3.1 DC Control Kp ID613

Gain for feedback control loop for voltage.

P2.6.3.2 DC Control Ti ID614

Integration for feedback control loop for voltage.

P2.6.3.3 DC PI Max Adjust ID1906

Maximum adjustment to voltage that PI controller can do. If Measured voltage and open loop calculated voltage difference is more that this drive will trip to F81 Closed Loop.

P2.6.3.4 CL Feed Back Loos response ID752

Response when feedback goes outside ID1906, regardless of response selection Closed Loop PI controlled will be disabled.

- 0 = No response
- 1 = Warning
- 2 = Fault

6.6.3 Voltage Feedback

P2.6.4.1 Feedback AnIN ID1595

Select analogue input that is used for feedback signal. When this input is not selected actual value can be given through fieldbus by connecting FB Process Data In 1 to monitoring signal ID1866

P2.6.4.2 Feedback Filter TC ID618

Set filtering time constant for feedback signal.

P2.6.4.3 Nom Vdc Signal Level ID337

Set here signal level when raw analogue input signal will be at Source Nom Voltage level.

$$\left(\frac{P2.1.2 SNV [Vdc]}{SVAMS (20 mA) [Vdc]} * (100\% - P2.6.4.4 ZVSL[\%]) \right) + P2.6.4.4 ZVSL[\%] = \text{Nom Vdc Signal Level}$$

SNV = Source Nom Voltage

SVAMS = Source Voltage At Max Signal

ZVSL = Zero Vdc Signal Level

Source Voltage At MaxSignal (20 mA) : Sensor signal in Vdc at 20 mA

P2.6.4.4 Zero Vdc Signal Level ID320

Set here analogue input signal level where Vdc will be zero Vdc.

6.7 Drive Control

P2.7.1 Switching frequency ID601

Default 5,0 kHz, recommended to keep default. When all phases are connected to source, source side will see 15 kHz switching frequency.

Maximum switching frequency is 6kHz for frame sizes FR/FR4-8 and 5kHz for FI/FR9-14 and the liquid cooled units. Lower switching frequency can be used to reduce derating, but filter inductance needs to be higher.

P2.7.2 Control Options 1 ID1707

B01= Reserved

B08= Reserved

P2.7.3 DC/DC Options ID1463

B12 = +4096 = Direct voltage control when voltage control mode selected.

Controls duty cycle of the converter directly instead of cascade control used in the standard voltage control mode. Use this control mode for DC-power supply applications where robustness against load steps is required.

6.7.1 Identification

P2.7.4.1 IU Offset ID668

Identified U phase current measurement offset, identified during identification run.

P2.7.4.2 IV Offset ID669

Identified U phase current measurement offset, identified during identification run.

P2.7.4.3 IW Offset ID670

Identified W phase current measurement offset, identified during identification run.

P2.7.4.4 Charge Resistance ID662

Resistance when charging, used for source voltage estimation after the filter. This parameter needs to be tuned manually. Tune the resistance higher or lower when comparing the actual battery voltage and Source Voltage. Tuning must be done when some amount of current is flowing to correct directions.

P2.7.4.5 Discharge Resistance ID665

Resistance when discharging, used for source voltage estimation after the filter. This parameter needs to be tuned manually. Tune the resistance higher or lower when comparing the actual battery voltage and Source Voltage. Tuning must be done when some amount of current is flowing to correct directions.

P2.7.4.6 DCLinkMeasCalib % ID549

To increase the DC-voltage accuracy you may use ID549 to adjust the DC-link voltage measurement shown by the converter. This parameter will add a small gain offset to the measured DC-link voltage value. This feature helps to balance the load sharing for parallel converters.

6.7.2 System Test

This parameter group is reserved for internal testing purposes.
Do not edit parameters in this group is not instructed to do so.

P2.7.5.1 Modulation Limit

ID1515

This parameter can be used to limit maximum modulation voltage on source side.

P2.7.5.2 Advanced Options 1

ID1560

B10 = +1024 = Fast DC-Link ripple compensation

B11+B10 = +3072 = Fast DC-Link ripple compensation + 300 Hz ripple compensation

P2.7.5.3 Advanced Options 2

ID1561

Reserved

P2.7.5.4 Inverse Synch

ID1857

P2.7.5.5 DC Ripple Compensation Kp

ID1897

Gain for DC-Link ripple compensation.

P2.7.5.6 DC Ripple Compensation Phase

ID1898

Phase for DC-Ripple compensation.

P2.7.5.7 DC Ripple Compensation Frequency

ID1899

Frequency for DC-Link ripple compensation.

6.7.3 Battery Emulator/Simulator

The DC/DC converter can be used as a current source and sink like a battery. The battery model in the converter emulates the battery voltage behavior. The model includes series resistance of the battery and no load voltage model. The voltage will drop according to series resistance when discharged and increase when charged. The voltage increase is simulated with negative resistance. Battery no load voltage changes as a function of state of charge according to parameters of the model. Power flow in the DC-link needs to be handled by AFE or other source and load.

There is also a simulation mode to show the emulated voltage without actually loading the converter. Danfoss provides a tool to calculate the model parameters based on the battery cell datasheet. Use the tool to parametrize the converter.

Battery model is given by equations:

1. $V_{battery} = E - R_{DC} * i$
2. $E = Source\ nominal\ voltage * (1 - K * (\frac{Q}{Q-it} - 1)) + A * e^{-B*it}$

Make sure P2.5.4.1 SourceMinVoltage and P.2.5.2 SourceMaxVoltage is not limiting the model voltage unintentionally.

P 2.7.6.1 EmulatorMode **ID3501**

0 = Disabled

DC/DC converter operates without battery emulation

1 = Emulator Mode

Battery emulation is active. Source voltage is defined by the model parameters. Note: P2.1.4 needs to be in voltage control mode to activate emulator mode.

2 = Simulator Mode

Battery emulation is running in simulation mode. NCDrive can be used to show the model voltage without applying the voltage at the output of the converter.

Use P2.1.6 Current Reference to charge and discharge the battery. Battery is charged and discharged ten times faster than actual(?)

P 2.7.6.2 Model A **%** **ID3502**

Defines voltage increase in the exponential zone of the battery voltage

P 2.7.6.3 Model B **%** **ID3503**

Defines shape of the exponential zone of the battery voltage

P 2.7.6.4 Model K **%** **ID3504**

Defines slope of the voltage change in the nominal zone

P 2.7.6.5 Model Q **%** **ID3505**

Defines virtual total capacity of the battery (zero voltage)

P 2.7.6.6 Model Qnomh **%** **ID3506**

Defines nominal capacity of the battery. Defines 100% SoC capacity.

P 2.7.6.7 Model R % **ID3507**

Battery internal resistance.

P 2.7.6.8 Model Set SoC % **ID3508**

User can initialize the state of charge of the battery model.

V 2.7.6.9 Model Voltage % **ID3509**

Model voltage monitoring variable.

V 2.7.6.10 Model SoC % **ID3510**

Model state of charge monitoring variable.

6.8 Master-Follower parameters

These parameters are used to set up parallel operation of DC/DC converter drives. When activated drives will interleave modulation to reduce voltage and current ripple.

Master drive control mode will be used in follower drives regardless of follower drive settings.

Master drive references will be used in follower drives regardless of follower drive settings.

Limit controllers are operational in follower drives.

Follower drives are “ramp” followers, i.e. follower drives are using e.g. ramp times set in master drive assuming limit controllers are not active.

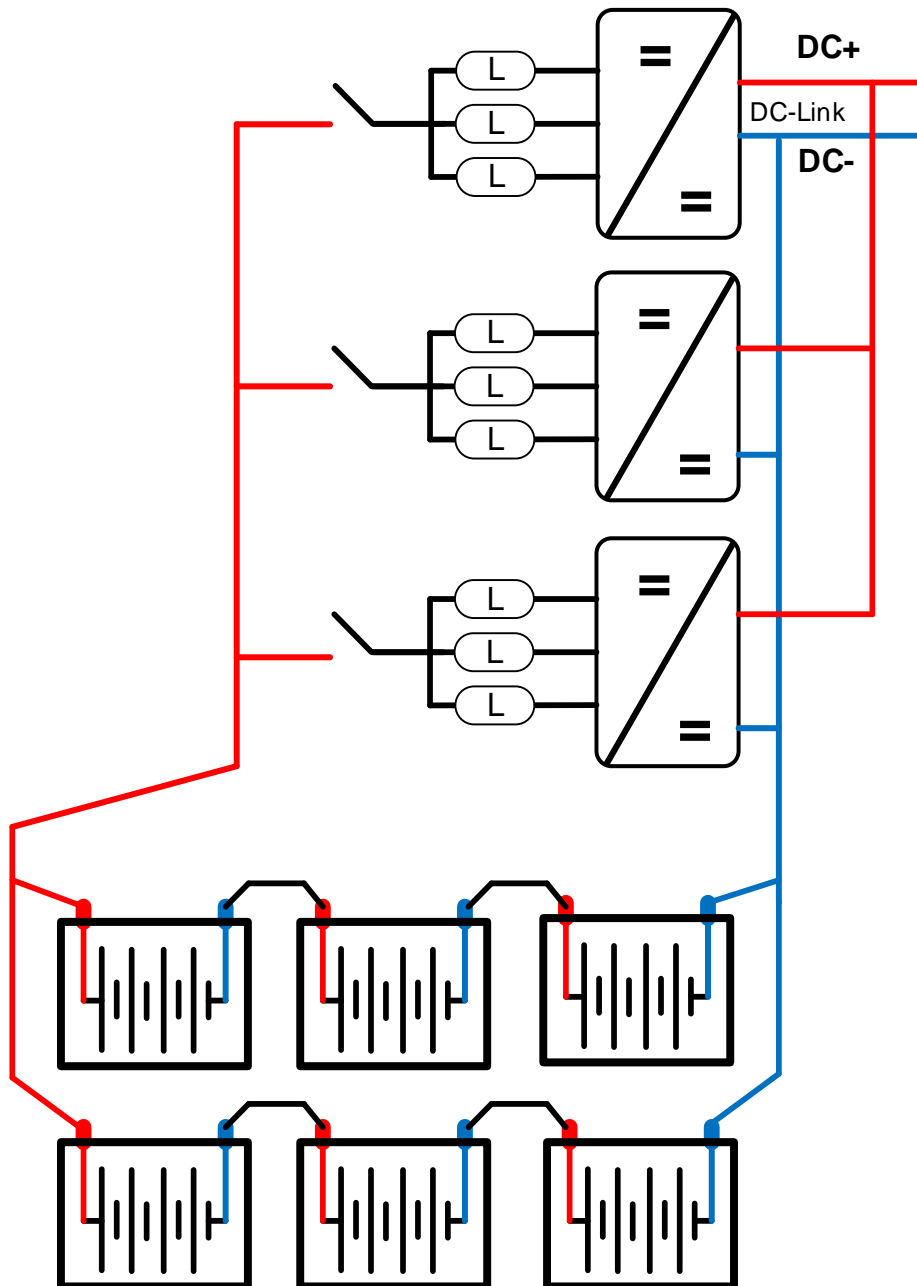

6.8.1 Master follower configuration

The OPTD2 board in the Master has default jumper selection, X5:1-2. For the followers, the jumper positions have to be changed: **X5:2-3**. This board also has a CAN communication option that is useful for multiple drive monitoring with NCDrive PC software when commissioning Master Follower functions or line systems. Older boards has X6, leave this to ON (X6:1-2).

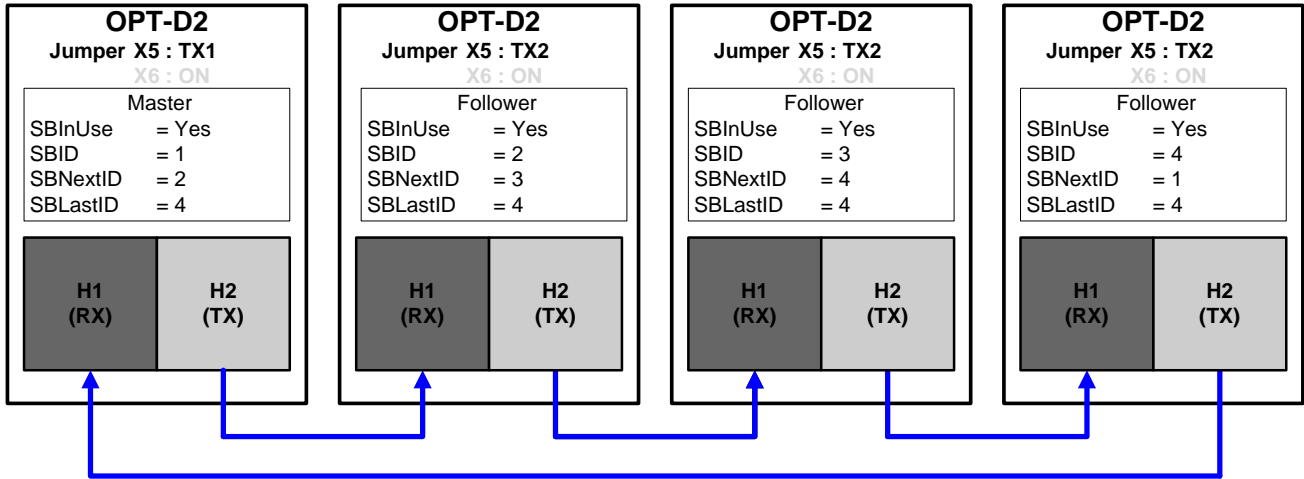

Figure 6-2. System bus physical connections with the OPT-D2 board

P2.8.1 Master/Follower selection ID1324 “MF Mode”

Select the Master Follower mode. When the drive is a follower, the Run Request command is monitored from Master but all references are selectable by parameters.

0 = Single drive

System bus is deactivated

1 = Master

Drive sends Master CW, Current Reference and Voltage Reference to follower drives.

2 = Follower

Drive receives control word from Master and references and sends some diagnostic information to the Master drive.

P2.8.2 SystemBus communication fault response ID1082 “SB Comm Fault”

Defines the action when the System Bus heartbeat is missing.

The master drive sends a heartbeat signal to all follower drives and this heartbeat is sent back to the master drive.

0 = No response

1 = Warning

2 = Fault

P2.8.3 SystemBus fault delay ID1352 “SB fault Delay”

Defines the delay before fault generation when heartbeat is missing.

P2.8.4 **SynchFaultResponse** **ID1701** **“SynchFaultResp”**

Defines response when interleaving modulation is not in synch

0 = No response

1 = Warning

2 = Fault

P2.8.5 **Follower Fault** **ID1536** **“Follower Fault”**

Defines the response in the Master drive when a fault occurs in any of the follower drives. When one of the drives trips to fault the master drive will send a command to trigger the Data Logger in all the drives for diagnostic purposes.

0 = No response

1 = Warning

2 = Fault, stop mode after fault according to Stop function

6.9 Fieldbus parameters

P2.9.1 *FB Actual Value Selector* *ID1853*

Select signal ID that is used as “FB Actual speed / Actual Value 1” from the drive.

P2.9.2 *GSW ID* *ID897*

Select the value for “FBGeneralStausWord”

**P2.9.3 - *Fieldbus data out 1-8 selection* *ID852-ID859*
P2.9.10**

Using these parameters, you can monitor any monitoring or parameter value from the fieldbus. Enter the ID number of the item you wish to monitor for the value of these parameters.

**P2.9.11 - *Fieldbus data out 9-16 selection* *ID558-ID565*
P2.9.18**

These are similar parameters as *P2.9.3-10*.

Note that these parameters are visible only if a Fieldbus board with support for 16 process data variables is inserted in slot D or E. By default, these parameters are not used.

P2.9.19 *FB Reference Selector* *ID1850*

Select where the fieldbus “FBSpeedReference / Reference 1” signal is connected in the application. Use only in ByPass mode.

**P2.9.20 - *Fieldbus data in 1-8 selection* *ID876-ID883*
P2.9.27**

Using these parameters, you can control any parameter from the fieldbus. Enter the ID number of the item you wish to control for the value of these parameters.

**P2.9.28 - *Fieldbus data in 9-16 selection* *ID550-ID557*
P2.9.35**

These are similar parameters as *P2.9.20-27*.

Note that these parameters are visible only if a Fieldbus board with support for 16 process data variables is inserted in slot D or E. By default, these parameters are not used.

P2.9.36 Control Slot Selector**ID1440**

This parameter defines which slot is used as the main control place when two fieldbus boards have been installed in the drive. When values 6 or 7 are selected, the drive can use a Fast fieldbus profile, if a fieldbus board with support for the Fast profile is inserted in slot D or E. When values 8 or 9 are selected the drive can use 16 process data variables if the used fieldbus board hardware and firmware support it. See the Fieldbus-board manual for further details.

0 = Not Sel.

4 = Slot D, Normal (8 process data variables)

5 = Slot E, Normal (8 process data variables)

6 = Slot D, Fast fieldbus support

7 = Slot E, Fast fieldbus support

8 = Slot D, Extended (16 process data variables)

9 = Slot E, Extended (16 process data variables)

P2.9.37 State Machine**ID896**

0 = Basic: This mode makes fieldbus control behaves as in explained in used fieldbus board manual.

1 = Standard: Simple control word that is used in modes where control word from fieldbus is used as such, for some fieldbus board this requires bypass operation.

6.10 Protections

6.10.1 General

P2.10.1.1 Response to external fault ID701

This parameter defines a response to external fault. If the drive monitors the state of external fault input (value of P2.2.1.7 > 0) and a fault occurs the drive can be set to respond to the fault.

- 0 = No response
- 1 = Warning
- 2 = Fault

P2.10.1.2 Max Charge Time ID1522

When drive charging options is used this parameter defines maximum time limit for charging. Use suitably sized DC Charging resistor by checking Pulse loadability for time duration set in for Max Charge Time parameter.

.6.10.1.1 4mA fault protection

The 4 mA protection monitors the analogue input signal level from Analogue input 1 and Analogue input 2. The monitoring function is active when signal is below minimum and there is a start request. A fault or warning is generated when the signal falls below 80 % of minimum for 5 seconds or below 50 % of minimum 0.5 seconds.

P2.10.1.3 Response to the 4mA reference fault ID700 "4mA Input Fault"

- 0 = No response
- 1 = Warning
- 2 = Fault.

P2.10.1.4 FaultWarnIndicat ID1940

With this parameter its possible to select how warning and fault indication as handled to digital outputs and to fieldbus

- 0 = Static

Static signal, as long as warning or fault is active

- 1 = Toggle

New fault or warning toggles signal for one second.

- 2 = Marine

Signal toggles in new fault or warning and status needs to be reset to get signal down.

6.10.2 Temperature Sensors

The temperature protection function is used to measure temperatures and issue warnings and/or faults when the set limits are exceeded. The DC/DC Converter application supports two OPT-BH and OPT-B8 board simultaneously.

P2.10.2.1 Number of used inputs in board 1 ID739 "Board1 Channels"

Select used temperature sensor combination with this parameter. See also the Vacon I/O boards manual.

- 0 = Not used (ID Write, value of maximum temperature can be written from fieldbus)
- 1 = Sensor 1 in use
- 2 = Sensor 1 & 2 in use
- 3 = Sensor 1 & 2 & 3 in use
- 4 = Sensor 2 & 3 in use
- 5 = Sensor 3 in use

Note: If the selected value is greater than the actual number of used sensor inputs, the display will read 200°C. If the input is short-circuited the displayed value is -30°C.

P2.10.2.2 Board 1 Temperature response ID740 "Board1 Response"

- 0 = No response
- 1 = Warning
- 2 = Fault, stop mode after fault according to Stop Function
- 3 = Fault, stop mode after fault always by coasting

P2.10.2.3 Board 1 warning limit ID741 "Board1Warn.Limit"

Set here the limit at which the PT100 warning will be activated.
When individual warning and fault limits are activated this is first board first channel (1A).

P2.10.2.4 Board 1 fault limit ID742 "Board1 Fault Lim."

Set here the limit at which the PT100 fault (F56) will be activated.
When individual warning and fault limits are activated this is first board first channel (1A).

6.10.3 Thermal Protection

P2.10.3.1 Response to thermistor fault ID732

- 0 = No response
- 1 = Warning
- 2 = Fault

Setting the parameter to 0 will deactivate the protection.

P2.10.3.2 Thermal Fault Delay ID707

Delay parameter before fault is triggered when switch type thermal inputs are used.

6.10.4 Fieldbus protection

P2.10.4.1 Response to fieldbus fault ID733 “FBComm.FaultResp”

Set here the response for a fieldbus fault if the active control place is fieldbus. For more information, see the respective Fieldbus Board Manual.

- 0 = No response
- 1 = Warning
- 2 = Fault.

P2.10.4.2 Fieldbus Watch Dog delay ID1354 “FB WD Delay”

Defines delay when fault is generated when watch dog pulse is missing from fieldbus. Set the time to zero to disable watchdog monitoring.

P2.10.5 *Fault Simulation* *ID1569* “*Fault Simulation*”

With this parameter it is possible to simulate different faults without actually making, for example, an over current situation. In the point of view of the drive interface, the operation is identical to actual fault situation.

B00 = +1 = Simulates an over current fault (F1)

B01 = +2 = Simulates an over voltage fault (F2)

B02 = +4 = Simulates an under voltage fault (F9)

B03 = +8 = Reserved

B04 = +16 = Simulates an earth fault (F3)

B05 = +32 = Reserved

B06 = +64 = Reserved

B07 = +128 = Simulates an over temperature warning (W14)

B08 = +256 = Simulates an over temperature fault (F14)

The warning bit must be active for a fault to appear in simulation. If the fault bit is left active, the drive will go FAULT state at warning limit when the drive temperature rises to the warning level.

B09 = +512 = Reserved

P2.10.6 *Reset Datalogger* *UD1849*

Parameter to reset data logger to its defaults. Recommended to reset settings after initial commissioning if changed.

6.11 ID Function

Listed here are the functions that use the parameter ID number to control and monitor the signal.

6.11.1 Value Control

The value control parameters are used to control an input signal parameter.

P2.11.1.1 Control Mode ID1586 “Control Mode”

This parameter defines how the value control output behaves.

0 = SR ABS

Absolute input value is used to make a step change in the output between On and Off values.

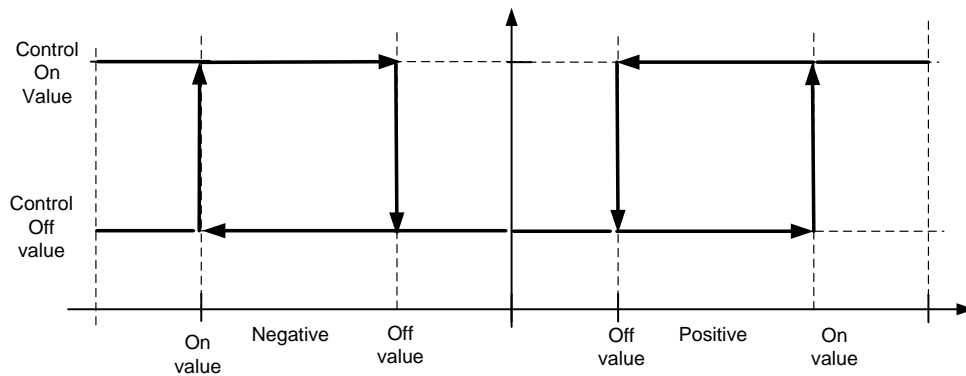

1 = Scale ABS

Absolute input value is scaled linearly between On and Off values.

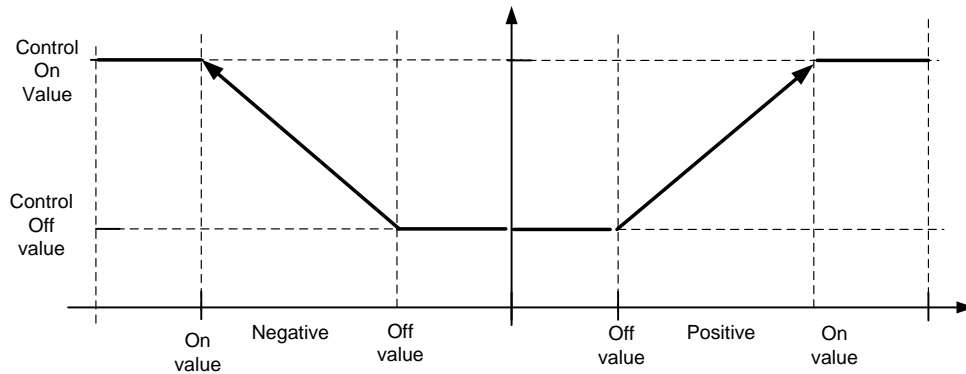

2 = Scale ABS Inverted

Inverted absolute value is scaled linearly between On and Off values.

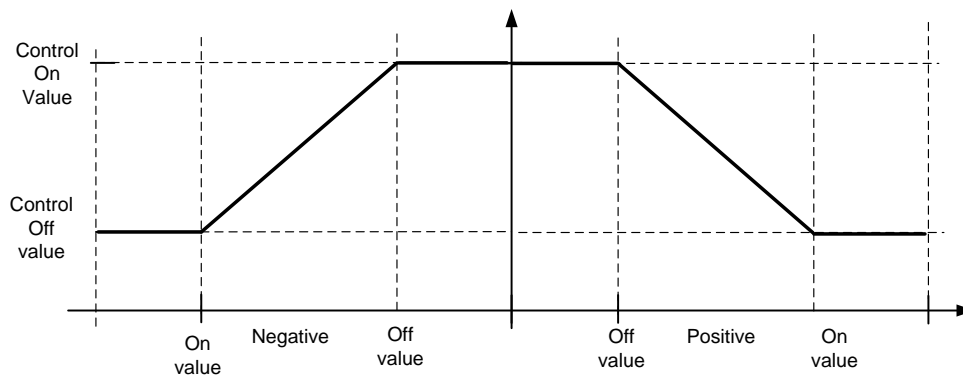
**3 = SR**

Input value is used to make a step change in the output between On and Off values.

4 = Scale

Input value is scaled linearly between On and Off values.

5 = Scale Inverted

Inverted value is scaled linearly between On and Off values

P2.11.1.2 Control Input Signal ID ID1580 "ContrInSignal ID"

With this parameter you can select what signal is used to control selected parameter.

P2.11.1.3 Control Off Limit ID1581 "Contrl Off Limit"

This parameter defines the limit when the selected parameter value is forced to Off value.

P2.11.1.4 Control On Limit ID1582 "Contrl On Limit"

This parameter defines the limit when the selected parameter value is forced to On value.

P2.11.1.5 Control Off Value ID1583 "Contrl Off Value"

This parameter defines the value that is used when the used input signal is below Off limit.

P2.11.1.6 Control On Value ID1584 "Contrl On Value"

This parameter defines the value that is used when the used input signal is above On limit.

P2.11.1.7 Control Output Signal ID ID1585 "ContrlOutSignID"

This parameter defines which parameter is forced to On and Off values when selected input signal exceeds the set limits.

P2.11.1.8 Control Signal Filtering TC ID1586 “Control Filt TC”

This parameter is used to filter the scaling function output. Used e.g. when unfiltered torque is used to control a parameter that needs stabilization.

.6.11.1.1 XY-Blot

With this function is possible to make own curve. e.g. selecting DC-Link voltage and make the points to control Current reference based on DC-Link voltage level. X-Values are input values and Y-values are outputs.

P2.11.1.9 X Value 01 ID1626

P2.11.1.10 Y Value 01 ID2001

P2.11.1.11 X Value 02 ID1627

P2.11.1.12 Y Value 02 ID2002

P2.11.1.13 X Value 03 ID1628

P2.11.1.14 Y Value 03 ID2003

P2.11.1.15 X Value 04 ID1629

P2.11.1.16 Y Value 04 ID2004

P2.11.1.17 X Value 05 ID1630

P2.11.1.18 Y Value 05 ID2005

P2.11.1.19 X Value 06 ID1631

P2.11.1.20 Y Value 06 ID2006

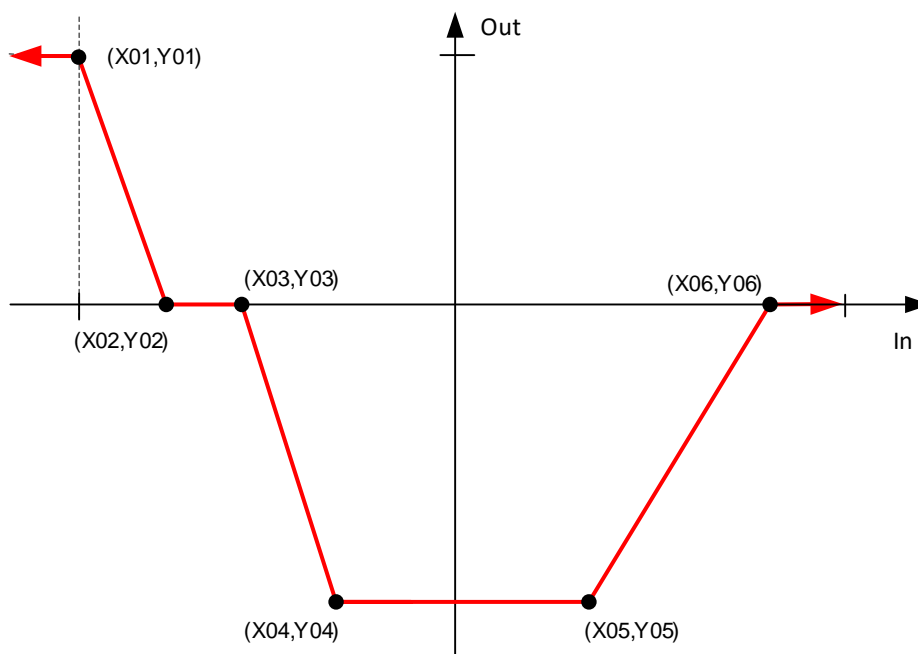

6.11.2 DIN ID Control

This function is used to control any parameter between two different values with a digital input. Different values are given for DI 'low' and DI 'high'.

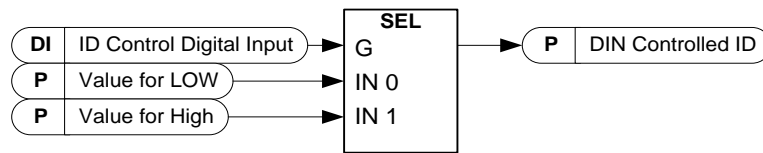

P2.11.2.1 ID Control Digital Input ID1570 “ID Control DIN”

P2.11.3.1 ID Control Digital Input ID1590 “ID Control DIN”

P2.11.4.1 ID Control Digital Input ID1578 “ID Control DIN”

Select digital input to be used for controlling the parameter selected by ID1571, ID1575 and 1579.

P2.11.2.2 DIN Controlled ID ID1571 “Controlled ID”

P2.11.3.2 DIN Controlled ID ID1575 “Controlled ID”

P2.11.4.2 DIN Controlled ID ID1579 “Controlled ID”

Select parameter ID controlled by ID1570.

P2.11.2.3 Value for Low digital input (FALSE) ID1572 “FALSE Value”

P2.11.3.3 Value for Low digital input (FALSE) ID1592 “FALSE Value”

P2.11.4.3 Value for Low digital input (FALSE) ID1594 “FALSE Value”

Set here the controlled parameter value when the digital input (ID1570) is LOW for the parameter selected by ID1571. The function does not recognize decimals. Give, therefore, e.g. 10.00 Hz as ‘1000’.

P2.11.2.4 Value for High digital input (TRUE) ID1573 “TRUE Value”

P2.11.3.4 Value for High digital input (TRUE) ID1593 “TRUE Value”

P2.11.4.4 Value for High digital input (TRUE) ID1596 “TRUE Value”

Set here the controlled parameter value when the digital input (ID1570) is HIGH for the parameter selected by ID1571. The function does not recognize decimals. Give, therefore, e.g. 10.00 Hz as ‘1000’.

6.12 Keypad control

3.1 **Control place ID1403**

The active control place can be changed with this parameter.

NOTE! Keypad is the default control place.

- 0 = PC Control
- 1 = I/O terminal
- 2 = Keypad (Default)
- 3 = Fieldbus

3.2 **License Key ID1995**

Set here license key to activate DC/DC Converter operation. FR4 unit size will operate without license key.

7. CONTROL AND STATUS WORDS

P2.9.20 State machine	
0 / Basic	This mode makes fieldbus control behave as in explained in used fieldbus board manual.
1 / Standard	Simple control word that is used in modes where control word from fieldbus is used as such, for some fieldbus board this requires bypass operation.

7.1 FB Control Word with Basic In Bypass

FB Control Word ID1160		
	Signal	Comment
B00	Run	0= DC/DC Drive is stopped 1= DC/DC Drive is started
B01		
B02	Fault Reset	0>1 Reset fault.
B03	FB DIN1	Can be used to control RO or directly parameter by ID number. G2.4.1
B04	FB DIN2	Can be used to control RO or directly parameter by ID number. G2.4.1
B05	FB DIN3	Can be used to control RO or directly parameter by ID number. G2.4.1
B06	FB DIN4	Can be used to control RO or directly parameter by ID number. G2.4.1
B07		
B08		
B09		
B10		
B11		
B12		
B13		
B14		
B15		

7.2 FB Control Word with Standard

FB Control Word ID1160		
	Signal	Comment
B00	DC Charge	0= Stop the drive and/or charging 1= Charge DC
B01		
B02		
B03	Run	0= DC/DC is stopped 1= DC/DC is started
B04		
B05		
B06		
B07	Reset	0>1 Reset fault.
B08		
B09		
B10	PLC Control	0= Disable FB Control 1= Enable FB Control
B11	FB DIN1/ Watchdog	Can be used to control RO or directly parameter by ID number. G2.4.1 This bit is connected also to FB Status Word B15
B12	FB DIN2	Can be used to control RO or directly parameter by ID number. G2.4.1
B13	FB DIN3	Can be used to control RO or directly parameter by ID number. G2.4.1
B14	FB DIN4	Can be used to control RO or directly parameter by ID number. G2.4.1
B15		This bit is connected

B00: FALSE = Stop Charging, TRUE = Charge DC

Stop Charging: Stop charging and/or Stops the drive.

Charge DC: Activates charging DO, will charge maximum 10 second, will stop earlier if DC CB feedback is received. Needs to be high even if charging option is not used.

B03: FALSE = Stop Request, TRUE = Start Request

Stop Request: Drive will stop .

Start Request: Start Command to the drive. Rising edge needed for start.

B07: FALSE = No significance, TRUE = Fault Acknowledge

Fault Acknowledge: The group signal is acknowledged with a positive edge.

B10: FALSE = Disable FB Control, TRUE = Enable FB Control

Disable FB Control: Drive will stop.

Enable FB Control: Start Command is monitored from fieldbus if control place fieldbus.

7.3 FB Status Word

FB Status Word ID68		
	Signal	Comment
b0	Ready On	0=Drive not ready to switch on 1=Drive ready to start charging
b1	Ready Run	0=Drive not ready to run 1=Drive ready and Main Contactor is ON
b2	Running	0=Drive not running 1=Drive in Run state (Modulating)
b3	Fault	0=No active fault 1=Fault is active
b4	Run Enable Status	0= Run Disabled. Drive in stop state 1= Run Enabled. Drive can be started.
b5	TRUE	
b6	Inhibit	0= Drive in operating condition. 1= Run disabled or fault state.
b7	Warning	0= No active warnings 1= Warning active
b8		
b9	Fieldbus Control Active	0=Fieldbus control not active 1=Fieldbus control active
b10	FALSE	
b11	FALSE	
b12	FALSE	
b13	FALSE	
b14	FALSE	
b15	Watchdog	Same as received on bit 11 of the main control word.

B00: FALSE = Not Ready to Switch On, TRUE = Ready to Switch On

Not Ready to Switch On: Fault active, DI: Run Enable low,
Ready to Switch On: No Faults, DI: Run Enabled,

B01: FALSE = Not Ready To Operate, TRUE = Ready To Operate

Not Ready To Operate: CW.B0 = FALSE, DC Not Ready,.
Ready To Operate: CW.B0 = TRUE, DC Ready,

B02: FALSE = Drive is not operating, TRUE = Drive is operational

Drive is not operating: Drive is not run state (modulating)
Drive is operational: Drive is in run state and modulating.

B03: FALSE = No Fault, TRUE = Fault Present

No Fault: Drive is not on fault state.
Fault Present: Drive is in fault state.

B04: FALSE = Run Disabled, TRUE = Run Enabled

Run Disabled: DI: Run Enable False,
Run Enabled: Running Enabled

B06: FALSE = Run not inhibited, TRUE = Run inhibited

Run not inhibited: No faults and Run Enabled
Run Inhibited: Fault Active or Run Disabled.

B07: FALSE = No Warning, TRUE = Warning Present

No Warning: There is no warning or the warning has disappeared again.

Warning Present: Drive still works; warning in the service/maintenance parameter; no acknowledgement.

B09: FALSE = No Control Requested, TRUE = Control Requested

No Control Requested: Control by the automation system is not possible.

Control Requested: The automation system is controlling.

B15: FALSE = FB DW Feedback Low, TRUE = FB DW Feedback High

FB DW Feedback: FB Control Word B11 is echoed back to the Fieldbus. Can be used to monitor communication status from the drive.

7.4 Status Word (Application) ID 43

Application Status Word combines different drive statuses to one data word.

Application Status Word ID43		
	FALSE	TRUE
b0	Closed Loop Control not active	Closed Loop Control active
b1	Not in Ready state	Ready
b2	Not Running	Running
b3	No Fault	Fault
b4	Discharging disabled, low voltage	Discharging Allowed
b5	Charging Disabled, high voltage	Charging Allowed
b6	Run Disabled	Run Enable
b7	No Warning	Warning
b8		Charging Switch closed (internal)
b9		Over Voltage Regulator Active
b10		Under Voltage regulator active.
b11		
b12	No Run Request	Run Request
b13		One or more regulators active
b14	Current/Power Control Mode	Voltage Control Mode.
b15		

B01: FALSE = Not Ready, TRUE = Ready

Not Ready: DC Voltage low, Fault active

Ready: Drive in ready state, start command can be given.

B02: FALSE = Not Running, TRUE = Running

Not Running: Drive is not modulating

Running: Drive is modulating.

B03: FALSE = No Fault, TRUE = Fault Active

No Faults: Drive do not have active faults.

Fault: Drive has an active faults.

B04: FALSE = Discharging disabled, TRUE = Discharging allowed

Discharging disabled:

Discharging allowed:

B05: FALSE = Charging disabled, TRUE = Charging allowed

Charging disabled:

Charging allowed:

B06: FALSE = Run Enable Low, TRUE = Run Enable High

Run Enable Low: Run Enable command to motor control is low

Run Enable High: Run Enable command to motor control is high.

B07: FALSE = No Warning, TRUE = Warning Active

No Warning: No warning signals active in the drive

Warning: Drive has active warning signal. Warning signal not stop the operation.

B08: FALSE = Charging Switch Open, TRUE = Charging Switch closed

Charging Switch Open: DC voltage level is not reached closing level or has drop below the opening level. This information is from drive motor control.

Charging switch Closed: DC voltage level is above closing limit and no interlock active internally.

B09: FALSE = OV Control not active, TRUE = OV Control active

OV Control not Active: x.

OV Control Active: x.

B10: FALSE = UV Control not active, TRUE = UV Control active

UV Control not active: x.

UV Control active: x.

B12: FALSE = No Run Request, TRUE = Run Request

No Run Request: Final Run Request command has not been given to motor control.

Run Request: Final Run Request command has been given to motor control.

8. PROBLEM SOLVING

While proper information is needed from the problem, it's also recommended to try with latest application- and system software versions available. Software is continuously developed and default settings are improved (See Chapter 1.13 Compatibility issues in parameters between versions).

Recommended signals for NCDrive

Type	Signal Name	Actual	Unit	Min
Value	Status Word	24904	n	
Value	DC Voltage	554		
Value	Active Current	-0,7		
Value	Active Curr. Ref.	0		
Value	Source DC Act.	0,05	%	0,00
Value	Source Ref. Final	80	%	0,00
Value	Power kW	0	kW	-300,0
Value	Source Meas. DC	80,91	%	0,00

Use the fastest communication speed (Baudrate: 57 600) and a 50 ms update interval for signals for the RS232 communication.

For the CAN communication, use a 1 Mbit communication speed and 7 ms update interval for signals.

When you contact the support, send the *.trn, *.par and Service info (*.txt) files with a description of the situation. If the situation is caused by a fault, take also the Datalogger data from the drive.

Note that Datalogger settings can be changed to catch correct situation and it's also to possible make manual force trig for Datalogger.

Before storing the parameter file, upload the parameters from the drive and save when NCDrive is in the ON-LINE state. If it is possible, do this while the problem is active.

It's also helpful to have single line diagram from the system where problem is faced.

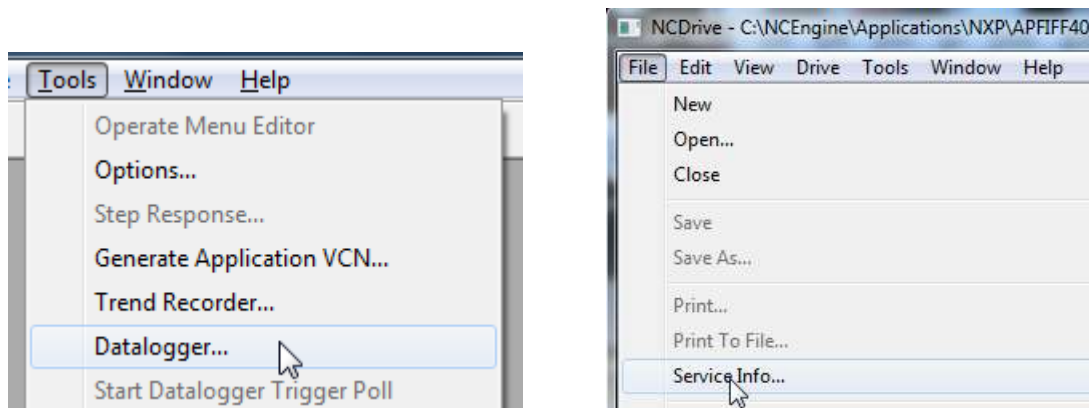

Figure 2. Datalogger window opening and Service Info upload.

9. FAULT CODES

The fault codes, their causes and correcting actions are presented below.

Note: When contacting distributor or factory because of a fault condition, always write down all texts and codes on the keypad display. Best way is to send parameter file and service info to Vacon technical support

This chapter includes all fault codes that are possible. but some faults are not possible in AFE application. And some faults description may be different when compared to standard frequency converter.

F1 Over current fault

Drive has detected a high current in the output phase.

S1 = Hardware trip:

Current above $4 \cdot I_h$

Possible cause and solutions

1. Sudden increase in load
 - Check motor load.
2. Short circuit in cables
 - Check cables.

F2 Overvoltage fault

DC-link voltage has exceeded the drive protection limits.

S1 = Hardware trip.

500 Vac unit DC voltage above 911 Vdc

690 Vac unit DC voltage above 1200 Vdc

S2 = Overvoltage control supervision (only 690 Vac unit).

DC voltage has been above 1100 Vdc for too long.

Possible cause and solutions

1. Too short a deceleration time
 - Increase deceleration time.
 - Use brake chopper and brake resistor.
 - Use Brake chopper unit.
2. High overvoltage spikes in supply
 - Check input voltage.

F3 Earth fault

Earth fault protection ensures that the sum of the phase currents is zero. The over current protection is always working and protects the frequency converter from earth faults with high currents.

S1 = Sum of output phase current is not zero

Possible cause and solutions

1. Insulation failure in cables

F5 *Charge switch*

Charge switch status is not correct when start command is given.

S1 = Charge switch was open when START command was given.

Possible cause and solutions

2. Charge switch was open when the START command was given.
 - Check connection of the feedback from charging relay
3. Reset the fault and restart.

Should the fault re-occur, contact your local distributor.

F7 *Saturation fault***S1 = Hardware failure**

- Cannot be reset from the keypad.
- Switch off power.
- DO NOT RE-CONNECT POWER!
- Contact your local distributor.

F8 *System Fault*

A system fault indicates several different fault situations in drive operation.

S1 = Reserved

- Disturbance. Reset the unit and try again.
- If there is star coupler in the unit, check the fibre connections and phase order.
- Driver board or IGBT broken.
- FR9 and the bigger size drives, which includes not star coupler, ASIC board (VB00451) is broken.
- FR8 and smaller size drives: control board broken.
- FR8 and smaller size drives: if there is boards VB00449 / VB00450 in use, failure might be in there.

S2 = Reserved**S3 = Reserved****S4 = Reserved****S5 = Reserved****S6 = Reserved****S7 = Charge switch****S8 = No power to driver card****S9 = Power unit communication (TX)****S10 = Power unit communication (Trip)****S11 = Power unit comm. (Measurement)****S12 = SystemBus synchronization has failed in DriveSynch operation****S30 = Safe disable inputs are in different state (OPT-AF)****S31 = Thermistor short circuit detected (OPT-AF)****S32 = OPT-AF board has been removed****S33 = OPT-AF board EEPROM error**

F9 *Undervoltage fault*

DC-link voltage is below the fault voltage limit of the drive.

S1 = DC-link too low during run

S2 = No data from power unit

S3 = Undervoltage control supervision

Possible cause

1. Too low a supply voltage
2. Frequency converter internal fault
3. One of the input fuses is broken.
4. External charge switch has not been closed.

Correcting measures

1. In case of temporary supply voltage break, reset the fault and restart the frequency converter.
2. Check supply voltage.
3. Check function of DC charge.
4. Contact your local distributor.

F10 *Line Synchronization Fault*

S1 = Phase supervision diode supply

S2 = Phase supervision active front end

Possible cause:

1. Input line phase is missing.

Correcting measures

1. Check supply voltage, fuses and cable.

F11 *Line phase supervision*

Current measurement has detected that there is no current in one phase or one phase current is considerably different from other phases.

Correcting measures

1. Check cables

F13 *Drive under temperature fault*

Possible cause:

1. Heatsink temperature is under -10°C

F14 *Drive over temperature fault***Possible cause:**

1. Heatsink temperature is over acceptable limits. See user's manual for the temperature limit. Overtemperature warning is issued before actual trip limit is reached.

Correcting measures

1. Check correct amount and flow of cooling air.
2. Check the heatsink for dust.
3. Check ambient temperature.
4. Make sure that switching frequency is not too high in relation to ambient temperature and motor load.

F22 *EEPROM checksum fault***Possible cause:**

1. Parameter save fault
2. Faulty operation
3. Component failure

Correcting measures:

1. Should the fault re-occur, contact your local distributor.

F24 *Counter fault***Possible cause:**

1. Values displayed on counters are incorrect

Correcting measures:

1. Have a critical attitude towards values shown on counters.

F25 *Microprocessor watchdog fault***Possible cause:**

1. Start-up of the drive has been prevented.
2. Run request is ON when a new application is loaded to the drive.

Correcting measures:

1. Reset the fault and restart.
2. Should the fault re-occur, contact your local distributor.

F26 *Start-Up prevention***Possible cause:**

1. Start-up of the drive has been prevented.
2. Run request is ON when a new application is loaded to drive

Correcting measures:

1. Cancel prevention of start-up if this can be done safely.
2. Remove Run Request.

F29 *Thermistor fault*

The thermistor input of the option board has detected too high a motor temperature.

Possible cause:

1. Motor is overheated.
2. Thermistor cable is broken.

Correcting measures:

1. Check motor cooling and load
2. Check thermistor connection (If thermistor input of the option board is not in use it has to be short circuited).

F31 *IGBT temperature*

IGBT Inverter Bridge over temperature protection has detected too high a short term overload current.

Possible cause:

1. Too high load
2. Identification run has not been made which causes the motor to start under magnetized.

Correcting measures:

1. Check load.
2. Check motor size.
3. Make identification Run.

F32 *Fan cooling***Possible cause:**

1. Cooling fan of the frequency converter does not start when ON command is given.

Correcting measures:

1. Contact your local distributor.

F37 *Device change*

Option board or power unit changed.

Possible cause:

1. New device of same type and rating.

Correcting measures:

1. Reset. Device is ready for use.

F38 *Device added*

Option board added.

Correcting measures:

1. Reset. Device is ready for use. Old board settings will be used.

F39 *Device removed*

Option board removed.

Correcting measures:

1. Reset. Device no longer available.

F40 *Device unknown*

Unknown option board or drive.

S1 = Unknown device**S2 = Power1 not same type as Power2****Correcting measures:**

1. Contact the distributor near to you.

F41 *IGBT temperature*

IGBT inverter bridge overtemperature protection has detected too high a short term overload current.

Correcting measures:

1. Check load.

*F44 Device changed (Default param.)***Possible cause:**

1. Option board or power unit changed.
2. New device of different type or different rating from the previous one.

Correcting measures:

1. Reset
2. Set the option board parameters again if option board was changed. Set converter parameters again if power unit was changed.

*F45 Device added (default param.)***Possible cause:**

1. Option board of different type added.

Correcting measures:

1. Reset
2. Set the option board parameters again.

*F50 4mA supervision***Possible cause:**

1. Current at the analogue input is below 4mA.
2. Signal source has failed
3. Control cable is broken or loose

Correcting measures:

1. Check the current loop circuitry.

*F51 External fault***Possible cause:**

1. Digital input fault.

Correcting measures:

1. Remove fault situation from external device.

*F52 Keypad communication***Possible cause:**

1. The connection between the control keypad or NCDrive and the AC drive is broken.

Correcting measures:

1. Check keypad connection and possible keypad cable.

*F53 Fieldbus communication***Possible cause:**

1. The data connection between the fieldbus Master and the fieldbus board is broken.

Correcting measures:

1. Check installation.
2. If installation is correct contact the nearest Vacon distributor.

F54 Slot fault**Possible cause:**

1. Defective option board or slot

Correcting measures:

1. Check board and slot.
2. Contact the nearest Vacon distributor.

F56 PT100 temperature fault

PT100 protection function is used to measure temperature and give warning and/or fault when set limits are exceeded. Marine application supports two PT100 boards. One can be used for the motor winding and the other for the motor bearings.

Possible cause:

1. Temperature limit values set for the PT100 board parameters have been exceeded

Correcting measures:

1. Find the cause of temperature rise

F59 SB Heart Beat (SystemBus communication)

The master drive sends pulses to all follower drives. If the pulses are missing a system bus communication fault is generated. The master drive also receives pulses back from the follower drives (max. four drives) and generates warnings if pulses are missing.

SystemBus communication is broken between master and follower.

Correcting measures:

- Check expander board parameters.
- Check optical fibre.
- Check option board jumpers.

F60 Cooling

Protection for the liquid-cooled units. An external sensor is connected to the drive (DI: Cooling Monitor) to indicate if cooling liquid is circulating. If the drive is in Stop state only a warning is issued. In Run state a fault is issued and the drive makes a coast stop.

Possible cause:

1. Liquid cooled drive cooling circulation have been failed

Correcting measures:

1. Check reason for cooling failure from external system.

F62 *Run Disabled*

Run Disable warning signal is issued when Run Enable signal has been removed from the IO.

F65 *PT100 board 2*

PT100 protection function is used to measure temperature and give a warning and/or a fault when the set limits are exceeded. Marine application supports two PT100 boards. One can be used for the motor winding and the other for the motor bearings.

Possible cause:

1. Temperature limit values set for the PT100 board parameters have been exceeded.
2. The number of inputs selected is higher than what is actually connected.
3. PT100 cable is broken

F72 *Enter License code*

License code has not been given or license code is wrong.

Correcting measures:

1. Check that correct serial number has been given to Vacon Key
2. Contact support with Service Infor

F74 *Follower fault*

When using the normal master follower function this fault code is given if one or more follower drives trip to fault. This fault is visible also when fault is in master drive. See also what other faults may be active in master drive.

Possible cause:

1. Fault in follower drive or in Master drive.

Correcting measures:

- Identify original fault and problem.

F76 *Synchronization fault*

Interleaving modulation is not synchronized between the drives.

Possible cause:

1. Different settings between the drives.
- 2.

Correcting measures:

1. Compare drive settings to be same.

F80 *Charging Fault*

The drive has not reached need DC voltage at set time.

Possible cause:

3. Charging circuit not operational.
4. High load in DC link.
5. Low voltage in supply for charging circuit.

Correcting measures:

2. Check charging current

F81 Closed Loop

Feedback signal deviate from calculated source voltage more than set limits.

Possible cause:

1. Set limits too narrow for used source.
2. Wire brake.

VAGON[®]

www.danfoss.com

Vacon Ltd
Member of the Danfoss Group

Runsorintie 7
65380 Vaasa
Finland

Document ID:



Rev. B