

**VACON<sup>®</sup> NX**

**AC DRIVES**

**ARFIF106**

**GRID CONVERTER**

**WITH GENERAL GRID CODES**

**APPLICATION MANUAL**

**VACON<sup>®</sup>**



**TABLE OF CONTENTS**

Document: DPD01978A  
 Software code: ARFIF106V160  
 Version release date: 14.11.2023

<b>1. General</b> .....	<b>9</b>
1.1 AFE Control .....	9
1.2 Island (Static Power Supply) .....	10
1.3 Micro Grid.....	11
1.4 Acronyms .....	12
1.5 Compatibility notes in between versions .....	13
1.5.1 ARFIF106V129 .....	13
1.5.2 ARFIF106V140 .....	14
1.5.3 NXP00002V205.....	15
1.6 Default currents of 500 Vac Air cooled unit .....	16
1.7 Default currents of 690 Vac Air Cooled unit .....	17
1.8 Default currents of 500 Vac Liquid Cooled unit .....	18
1.9 Default currents of 690 Vac Liquid Cooled unit .....	19
1.10 Current scaling in different size of units .....	20
<b>2. Grid Codes</b> .....	<b>21</b>
2.1 General.....	21
<b>3. Quick start and operation principles</b> .....	<b>22</b>
3.1 Quick start instructions.....	22
3.2 In case of parallel AFE: .....	22
3.3 Pre-Charging of DC .....	24
3.4 Main circuit breaker control (MCB).....	25
3.5 Start Sequence .....	26
3.6 Stop sequence .....	27
3.7 Start Stop timing diagram .....	28
3.8 Start Stop Timing Diagram with Grid Codes.....	29
3.9 Operation principle: Droop Speed Control Mode .....	30
3.10 Operation principle: Isochronous Control Mode .....	30
3.11 Voltage compensation .....	31
3.12 OPT-D7 voltage measurement option board .....	32
3.13 Master Follower .....	33
3.13.1 General .....	33
3.13.2 Grid Converter Standard master follower .....	33
3.13.3 Grid Converter DriveSynch .....	33
3.13.4 Grid Converter D2-Synch.....	33
3.14 Scaling high voltages for the grid converter .....	35
<b>4. Control I/O</b> .....	<b>36</b>
4.1 Slot A and Slot B terminals.....	36
4.2 Terminal To Function (TTF) .....	36
4.1 Defining inputs and outputs.....	37
4.1 Defining a terminal in NCDrive.....	38

5.	<b>Monitoring signals</b> .....	<b>39</b>
5.1	Monitoring value tables.....	40
5.1.1	Monitoring values 1.....	40
5.1.2	Monitoring values 2.....	41
5.1.3	Fieldbus monitoring values.....	41
5.1.4	I/O monitoring values.....	42
5.1.5	Master / Follower.....	42
5.1.6	Licence activation status .....	42
5.1.7	Grid Code .....	43
5.1.8	PI Power Controller .....	43
5.1.9	Active Limits .....	43
5.1.10	Line Monitoring .....	43
5.2	Description of monitoring values .....	44
5.2.1	Monitoring 1 values.....	44
5.2.2	Monitoring 2 values.....	48
5.2.3	Fieldbus monitoring values.....	51
5.2.4	I/O monitoring values.....	57
5.2.5	Master Follower .....	58
5.2.5.1	<b>Currents</b> .....	<b>59</b>
5.2.5.2	<b>Statuses</b> .....	<b>60</b>
5.2.6	Licence activation status .....	61
5.2.7	Grid Code .....	62
5.2.8	PI Power Controller .....	65
5.2.9	Active Limits .....	65
5.2.10	Line Monitoring .....	65
6.	<b>Parameter list</b> .....	<b>67</b>
6.1	Basic parameters .....	67
6.2	Reference handling .....	67
6.2.1	DC Reference Tuning.....	68
6.2.2	Power / Frequency reference .....	68
6.2.2.1	<b>PID Power Controller for AFE</b> .....	<b>69</b>
6.2.2.2	<b>High Frequency Power Reference</b> .....	<b>69</b>
6.2.2.3	<b>Low Frequency Power Reference</b> .....	<b>69</b>
6.2.3	Reactive Reference .....	70
6.2.4	AC voltage reference .....	70
6.3	Ramp control .....	70
6.4	Input signals .....	71
6.4.1	Basic settings .....	71
6.4.2	Digital inputs .....	72
6.4.3	Analogue input 1 .....	73
6.4.4	Analogue input 2 .....	73
6.4.5	Analogue input 3 .....	74
6.4.6	Analogue input 4 .....	74
6.5	Output signals.....	75
6.5.1	Digital output signals.....	75
6.5.2	Delayed DO 1 .....	76
6.5.3	Delayed DO 2 .....	76
6.5.4	Analogue output 1 .....	77
6.5.5	Analogue output 2 .....	78
6.5.6	Analogue output 3 .....	79
6.5.7	Options.....	79

6.6	Limit settings .....	80
6.6.1	Current limit .....	80
6.6.2	Power limit .....	80
6.6.3	Frequency limit .....	80
6.6.4	Micro Grid .....	80
6.6.5	DC voltage .....	81
6.7	Drive control .....	81
6.7.1	AFE control .....	81
6.7.2	Identification .....	82
6.7.3	Active Compensation .....	82
6.8	Master/Follower .....	82
6.9	Protections .....	83
6.9.1	General .....	83
6.9.2	PT-100 .....	84
6.9.3	Earth fault .....	84
6.9.4	Fieldbus fault .....	84
6.9.5	External fault .....	85
6.9.6	Grid voltage D7 .....	85
6.9.7	Grid frequency .....	85
6.9.8	Supply Voltage .....	85
6.9.9	Over Load .....	86
6.9.10	OPT-D7 protections .....	86
6.9.11	Cooling protection .....	86
6.9.12	Extra .....	86
6.10	Fieldbus .....	87
6.11	Micro Grid .....	88
6.12	Synchronisation to external grid .....	89
6.13	Reserved .....	89
6.14	ID control functions .....	90
6.14.1	Value control .....	90
6.14.1.1	<b>XY-Plot .....</b>	<b>90</b>
6.14.2	DIN ID control 1 .....	91
6.14.3	DIN ID control 2 .....	91
6.14.4	DIN ID control 3 .....	92
6.14.5	DIN ID control 4 .....	92
6.14.6	ID Controlled Digital Output 1 .....	92
6.14.7	ID Controlled Digital Output 1 .....	92
6.15	Auto Fault reset .....	92
6.16	Grid voltage PI .....	93
6.17	Grid Code parameters .....	94
6.17.1	Anti-islanding .....	94
6.17.2	FRT (Fault Ride-Through) .....	94
6.17.2.1	<b>FRT Timer .....</b>	<b>94</b>
6.17.3	Reconnection .....	95
6.17.4	Line Voltage trip limits .....	95
6.17.5	Line Frequency trip limits .....	96
6.17.6	Dynamic reactive current injection .....	97
6.17.6.1	<b>Linear Under Voltage .....</b>	<b>97</b>
6.17.6.2	<b>Linear Over Voltage .....</b>	<b>97</b>
6.17.6.3	<b>Power Lock Under Voltage .....</b>	<b>97</b>
6.17.6.4	<b>Power Lock In/Out Over Voltage .....</b>	<b>97</b>
6.17.6.5	<b>Dynamic Grid Support .....</b>	<b>98</b>

6.17.7	Reactive power control .....	99
6.17.7.1	Q(U) Power .....	99
6.17.7.2	Q(U) Curve .....	99
6.17.7.3	Q(P) curve .....	99
6.17.7.4	Options .....	100
6.17.8	Power Limit/Reference .....	100
6.17.8.1	General .....	100
6.17.8.2	High Frequency Power Limit .....	100
6.17.8.3	High Voltage Power Limit .....	100
6.17.8.4	Low Voltage Charge Limit .....	100
6.17.8.5	Low Frequency Charge Limit .....	101
6.17.9	Power Reference .....	102
6.17.9.1	Low Frequency Power Reference .....	102
6.17.9.2	High Frequency Power Reference .....	102
6.17.9.3	High Voltage Power Reference .....	102
6.17.9.4	Options .....	102
6.17.10	Cos Phii Control .....	104
6.17.10.1	Voltage Log In Log Out .....	104
6.17.10.2	Active Current .....	104
6.17.11	External Input .....	104
6.17.12	Limited Grid Support .....	104
6.17.13	Options .....	105
6.18	Keypad control (Control panel: menu M3) .....	106
6.19	System menu (Control panel: menu M6) .....	106
6.20	Expander boards (Control panel: menu M7) .....	106
<b>7.</b>	<b>Description of parameters .....</b>	<b>107</b>
7.1	Basic parameters .....	107
7.1.1	Transformer parameters .....	109
7.2	Reference handling .....	110
7.2.1	DC Reference Tuning .....	112
7.2.2	Power /frequency reference .....	113
7.2.2.1	PID Power Controller .....	117
7.2.2.2	High Frequency Power Reference AFE Operation .....	121
7.2.2.3	Low Frequency Power Reference AFE operation .....	123
7.2.3	Reactive Reference Tuning .....	125
7.2.4	AC Voltage Reference .....	126
7.3	Ramp control .....	130
7.3.1	Transformer magnetization .....	130
7.4	Input signals .....	132
7.4.1	Basic settings .....	132
7.4.2	Digital input signals .....	134
7.4.2.1	Synchronization to external grid .....	135
7.4.2.2	Forced control place .....	137
7.4.3	Analogue inputs 1-4 .....	139
7.4.3.1	Analogue input to any parameter .....	141
7.5	Output signals .....	142
7.5.1	Digital output signals .....	142
7.5.1.1	Fieldbus digital inputs connection .....	143
7.5.2	Delayed digital output 1 & 2 .....	144
7.5.3	Analogue output 1 & 2 & 3 .....	145
7.5.4	Options .....	149
7.6	Limit settings .....	151
7.6.1	Current limits .....	151

7.6.2	Power limits.....	155
7.6.3	Frequency limits.....	156
7.6.4	Micro Grid limits.....	157
7.6.5	DC voltage regulators .....	158
7.7	Drive control .....	160
7.7.1	AFE Control .....	164
7.7.2	Identification.....	165
7.7.3	Active Compensation .....	165
7.8	Master/Follower .....	166
7.9	Protections.....	168
7.9.1	General settings.....	168
7.9.1.1	<b>Charging fail.....</b>	<b>168</b>
7.9.2	PT-100.....	172
7.9.2.1	<b>Individual channel monitoring .....</b>	<b>173</b>
7.9.3	Earth fault .....	174
7.9.4	Fieldbus .....	174
7.9.5	External fault.....	175
7.9.6	Grid voltage D7 .....	176
7.9.7	Grid frequency.....	178
7.9.8	Supply voltage .....	179
7.9.9	Over Load Protection .....	181
7.9.10	D7 protections .....	182
7.9.11	Cooling protection.....	183
7.9.12	Extra.....	183
7.10	Fieldbus.....	185
7.11	Micro Grid (uGrid).....	188
7.11.1	Generator Simulation .....	191
7.11.2	AFE operation mode selection .....	191
7.12	Synch to external grid .....	192
7.13	ID functions.....	194
7.13.1	Value control .....	194
7.13.1.1	<b>XY-Plot.....</b>	<b>196</b>
7.13.2	DIN ID control.....	197
7.13.3	ID Controlled Digital Output .....	198
7.14	Auto Fault Reset .....	199
7.15	Grid voltage PI controller.....	200
7.15.1	Grid voltage PI OPT-D7 limits .....	201
7.16	Grid Code parameters.....	202
7.16.1	Anti-Islanding.....	203
7.16.2	FRT (Fault Ride-Through).....	205
7.16.2.1	<b>FRT Timer.....</b>	<b>207</b>
7.16.3	Reconnection.....	209
7.16.3.1	<b>Line OK Limits.....</b>	<b>209</b>
7.16.4	Line Voltage trip limits.....	210
7.16.5	Line Frequency trip limits .....	214
7.16.6	Reactive current injection (dynamic) .....	216
7.16.6.1	<b>Linear reference under voltage.....</b>	<b>217</b>
7.16.6.2	<b>Linear reference over voltage .....</b>	<b>218</b>
7.16.6.3	<b>Power Lock In and Out Reference under voltage.....</b>	<b>220</b>
7.16.6.4	<b>Power Lock In and Out Reference over voltage.....</b>	<b>223</b>
7.16.6.5	<b>Dynamic Grid Support .....</b>	<b>226</b>
7.16.7	Reactive Power Control .....	228

7.16.7.1	Q(U) Power .....	228
7.16.7.2	Q(U) Curve .....	231
7.16.7.3	Q(P) Curve.....	232
7.16.7.4	Options.....	233
7.16.8	Power Limit .....	234
7.16.8.1	General.....	234
7.16.8.2	High Frequency Power Limit.....	235
7.16.8.3	High Frequency Power Limit with absolute high frequency limit.....	237
7.16.8.4	High Voltage Power Limit .....	238
7.16.8.5	Low Voltage Charge Limit .....	240
7.16.8.6	Low Frequency Charge Limit.....	241
7.16.9	Power Reference.....	243
7.16.9.1	Low Frequency Power Reference.....	243
7.16.9.2	High Frequency Power Reference .....	246
7.16.9.3	High Voltage Power Reference .....	249
7.16.9.4	Options.....	249
7.16.10	Cos Phii Control.....	250
7.16.10.1	Lock In and Out control .....	250
7.16.10.2	Cos Phii Active Current Control.....	251
7.16.11	External Input .....	252
7.16.12	Limited Grid Support.....	252
7.16.13	Grid Code Options .....	253
<b>8.</b>	<b>Keypad control parameters .....</b>	<b>256</b>
<b>9.</b>	<b>FB Status and control in detail .....</b>	<b>257</b>
9.1	FB DC Reference .....	257
9.2	State machine: Basic.....	258
9.2.1	FB Control Word Basic .....	258
9.3	State Machine: Standard.....	259
9.3.1	Control Word: Standard.....	259
9.4	State machine: Vacon AFE 1 .....	260
9.4.1	Control Word: Vacon AFE 1 .....	260
9.1	State machine: Vacon AFE 2.....	261
9.1.1	Control Word: Vacon AFE 2 Profile (3).....	261
9.2	FB Status Word.....	263
<b>10.</b>	<b>Problem solving .....</b>	<b>265</b>
<b>11.</b>	<b>Commissioning .....</b>	<b>266</b>
11.1	Open loop voltage compensation .....	266
11.1.1	Parameters affect .....	266
11.1.2	No load tuning .....	267
11.1.3	Tuning with load.....	267
11.1.3.1	Tuning on the fly .....	267
11.1.3.2	Tuning with load bank.....	267
11.1.3.3	Tuning against strong grid .....	267
11.1.4	Closed Loop Voltage Control .....	268
<b>12.</b>	<b>Fault codes .....</b>	<b>269</b>



## 1. GENERAL

This application is not kept backwards compatible. See chapter Compatibility issues before you update the application. The Grid Converter application is used to make AC grids with a possibility to operate in parallel with other power sources. The Grid Converter application has three different operation modes and only AFE mode supports grid codes:

- AFE mode with and without grid codes activated.
- Island mode (no grid code support).
- Micro Grid mode (no grid code support).

### 1.1 AFE CONTROL

AFE function keeps constant DC voltage. AFE mode transfers power between DC and AC. AFE cannot create grid by itself, it needs to be connected to existing grid.

**NOTE!** Recommended to have transformer delta winding on drive side always.

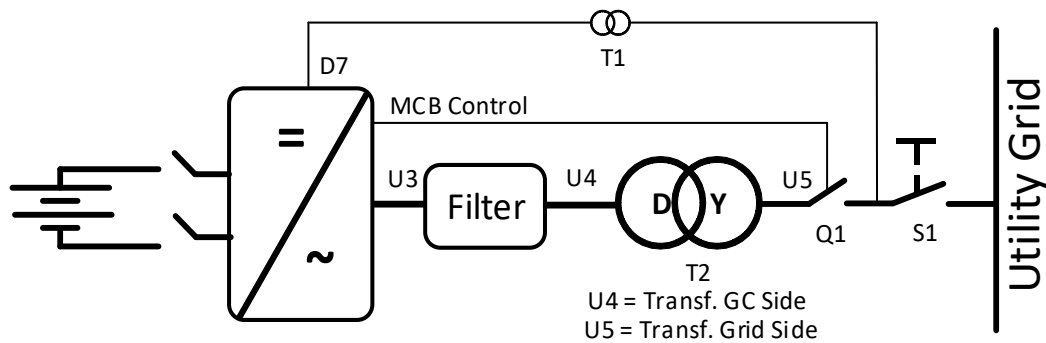

Figure 1.

## 1.2 ISLAND (STATIC POWER SUPPLY)

Island mode generates constant voltage and frequency. In island mode DC Voltage is not controlled. Island mode cannot operate in parallel with other power sources in AC side, because the drive will not balance reactive or active power with other power sources.

**DC voltage level needs to be considered to have correct voltage on AC side in different load situations, considering voltage losses in LCL filter and in transformer.**

**NOTE!** Recommended to have transformer delta winding on drive side always.

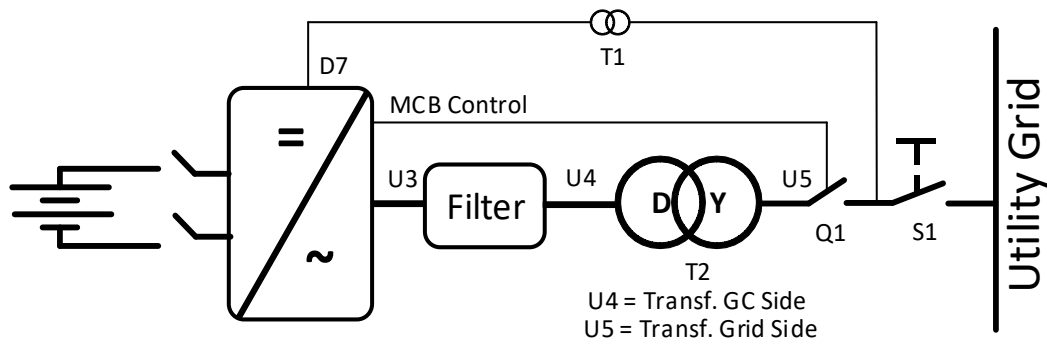

Figure 2.

### 1.3 MICRO GRID

Micro Grid mode controls the grid voltage and frequency. It functions like an ordinary generator. Micro Grid mode does not control DC Voltage.

With the help of voltage droop and frequency droop, more than one Micro Grid and/or Generators can work together.

**NOTE!** Recommended to have transformer delta winding on drive side always.

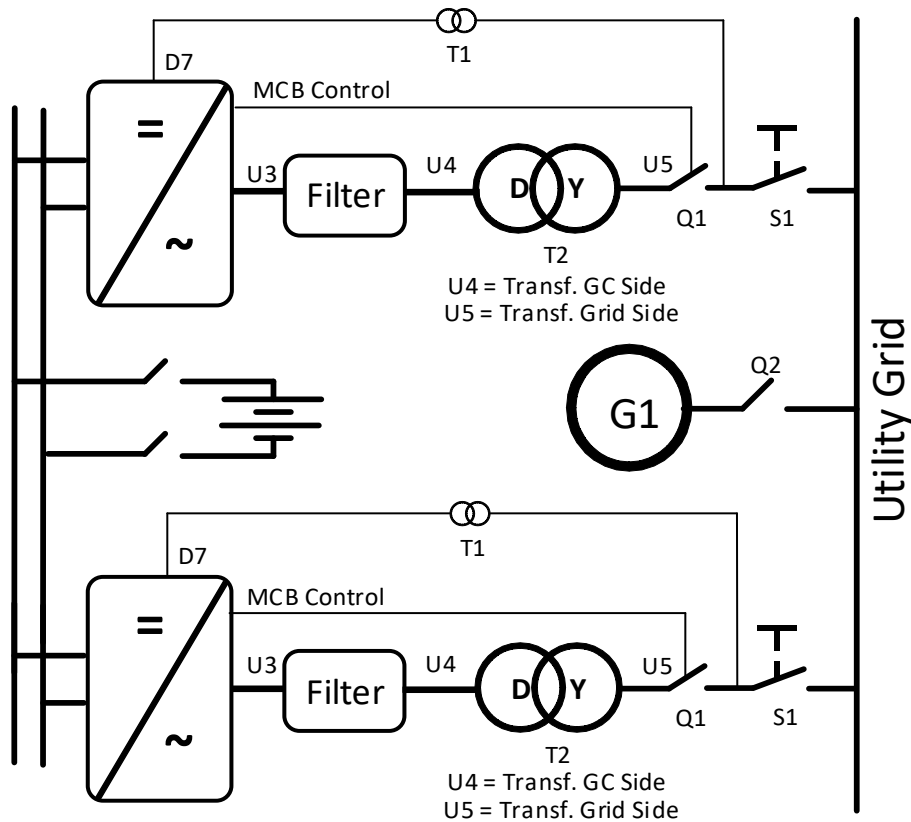

Figure 3.

## 1.4 ACRONYMS

AC	=	Alternating Current
AI	=	Analogue Input
AIO	=	All-In-One Applications
AM	=	Asynchronous Motor
ASIC	=	Application Specific Integrated Circuit
CL	=	Closed Loop
DC	=	Direct Current
DI	=	Digital Input
DO	=	Digital Output
DS	=	DriveSynch
FB	=	Field Bus
FFT	=	Function To Terminal
FW	=	Firmware
FWP	=	Field Weakening Point
FWPV	=	Field Weakening Point Voltage
GE	=	Greater or Equal
HW	=	Hardware
I/f	=	Current / Frequency
Id	=	Magnetization Current
IGBT	=	Insulated Gate Bipolar Transistor
INV	=	Inversion
Iq	=	Torque Producing Current
k-factor	=	Reactive relation to voltage. $k = (\Delta i_q / I_n) / (\Delta U / U_n)$
LT	=	Less Than
MF	=	Master-Follower
OL	=	Open Loop
OV	=	Over Voltage
PID	=	Proportional Integral Derivative
PM	=	Permanent Magnet
PMS	=	Power Management System
PMSM	=	Permanent Magnet Synchronous Motor
PU	=	Per Unit
RO	=	Relay Output
RS	=	Reset Set
SB	=	System Bus
Sep.Ex SM	=	Separately Excited Synchronous Motor
SM	=	Synchronous Machine
SPC	=	Speed Control
SQS	=	Safe Quick Stop
SR	=	Set Reset
SRM	=	Synchronous Reluctance Motor
SS1	=	Safe Stop 1
STO	=	Safe Torque Off
SW	=	Software
TC	=	Torque Control
TC	=	Time Constant
TTF	=	Terminal To Function
U/f	=	Voltage / Frequency
UV	=	Under Voltage

## 1.5 COMPATIBILITY NOTES IN BETWEEN VERSIONS

**Update Note 1:** This application parameters are not kept backwards compatible if new features or improvements would be difficult to implement by doing so. Read this change note and chapter “Compatibility issues in parameters between versions” from manual before updating the application.

**Update Note 2:** It's recommended to use compare function for parameter changes when updating application, especially in cases when version number change is considerably high. Application is constantly developed; this includes changing parameter default values, and if parameters are directly downloaded to drive improved default values may be lost.

### 1.5.1 ARFIF106V129

- **Compatibility Note:** ID3322 has two instances in parameters
  - P2.17.4.2 LF MaxChangeRate ID3322
  - P2.17.8.14 LF MaxChangeRate ID3322
  - These has been now separated to two separate parameters
    - P2.17.4.2 LF MaxChangeRate ID3322
    - P2.17.8.14 LF MaxChangeRate ID3514
- **Compatibility Note:** ID3291 has two instances in parameters
  - P2.17.9.3.1 UV High Corner ID3291
  - P2.17.9.5.4 UV High Corner ID3291
  - These has been now separated to two separate parameters
    - P2.17.9.3.1 UV High Corner ID3291
    - P2.17.9.5.4 UV High Corner ID3515
- **Compatibility Note:** ID3292 has two instances in parameters
  - P2.17.9.3.2 UV Low Corner ID3292
  - P2.17.9.5.5 UV Low Corner ID3292
  - These has been now separated to two separate parameters
    - P2.17.9.3.2 UV Low Corner ID3292
    - P2.17.9.5.5 UV Low Corner ID3516
- **Compatibility Note:** ID3293 has two instances in parameters
  - P2.17.9.3.3 UV Reac.MaxRef ID3293
  - P2.17.9.5.8 UV Reac.MaxRef ID3293
  - These has been now separated to two separate parameters
    - P2.17.9.3.2 UV Reac.MaxRef ID3293
    - P2.17.9.5.8 UV Reac.MaxRef ID3517

- **Compatibility Note:** ID3294 has two instances in parameters
  - P2.17.9.3.4 UV Bi React. Ref ID3294
  - P2.17.9.5.9 UV Bi React. Ref ID3294
  - These has been now separated to two separate parameters
    - P2.17.9.3.4 UV Bi React. Ref ID3294
    - P2.17.9.5.9 UV Bi React. Ref ID3518
- **Compatibility Note:** ID3300 has two instances in parameters
  - P2.17.9.4.1 OV Low Corner ID3300
  - P2.17.9.6.4 OV Low Corner ID3300
  - These has been now separated to two separate parameters
    - P2.17.9.4.1 OV Low Corner ID3300
    - P2.17.9.6.4 OV Low Corner ID3519
- **Compatibility Note:** ID3301 has two instances in parameters
  - P2.17.9.4.2 OV Max Reactiv ID3301
  - P2.17.9.6.8 OV Max Reactiv ID3301
  - These has been now separated to two separate parameters
    - P2.17.9.4.2 OV Max Reactiv ID3301
    - P2.17.9.6.8 OV Max Reactiv ID3543
- **Compatibility Note:** ID3346 has two instances in parameters
  - P2.17.13.3.3 MaxCosRef ID3346
  - P2.17.13.4.5 MaxCosRef ID3346
  - These has been now separated to two separate parameters
    - P2.17.13.3.3 MaxCosRef ID3346
    - P2.17.13.4.5 MaxCosRef ID3544

### 1.5.2 ARFIF106V140

There are ID numbers that are not accessible with all fieldbuses. In this version below monitoring variables has two ID numbers that can be used. Recommendation is to use ID numbers ID35xx, ID numbers ID22xx may be removed in later releases.

- |                          |        |        |
|--------------------------|--------|--------|
| ○ V1.7.1 Grid Code State | ID2203 | ID3548 |
| ○ V1.7.2 Line State      | ID2202 | ID3547 |
| ○ V1.7.10 Trip State     | ID2206 | ID3549 |

**1.5.3 NXP00002V205**

P2.1.11 Transf.PhaseShif ID1852 is offsetting V1.2.4 D7 Synch Error signal ID1659 thus considering in calculation the transformer phase shift when using synchronization to external grid. Therefore P2.12.1 Synch. Offset ID1601 and P2.12.2 Synch Reference ID1611 can be left to zero and is needed to set to zero when updating system software to V205 or newer if P2.1.11 Transf.PhaseShif ID1852 has been set correctly.

## 1.6 DEFAULT CURRENTS OF 500 VAC AIR COOLED UNIT

Converter type Air Cooled 500 Vac	Unit Size Index	P2.1.6 Grid Converter Rated Current (Default)	P2.6.1.1 Current Limit (Default)	P2.6.1.1 Current Limit (Maximum)
12	120	9,0	12,0	18,0
16	123	12,0	16,0	24,5
22	140	16,0	22,0	32,0
31	150	22,0	31,0	44,0
38	160	31,0	38,0	62,0
45	170	38,0	46,0	76,0
61	180	45,0	61,0	90,0
72	190	61,0	72,0	122,0
87	200	72,0	87,0	144,0
105	210	87,0	105,0	174,0
140	220	105,0	140,0	210,0
168	230	140,0	170,0	280,0
205	240	168,0	205,0	336,0
261	250	205,0	261,0	349,0
300	260	261,0	300,0	444,0
385	270	300	385	540
460	280	385	460	693
520	290	460	520	828
590	300	520	590	936
650	310	590	650	1062
730	320	650	730	1170
820	330	730	820	1314
920	335	820	920	1476
1030	340	820	1030	1656
1030	345	920	1030	1656
1150	350	1030	1150	1854
1300	355	1150	1300	2070
1370	360	1150	1370	2484
1450	365	1300	1450	2340
1640	370	1370	1640	2808
2060	380	1640	2060	3280
2300	390	2060	2300	4120
2643	400	2300	2643	4600
2400	1000	2400	2900	3000



**1.7 DEFAULT CURRENTS OF 690 VAC AIR COOLED UNIT**

<i>Converter type Air Cooled 690 Vac</i>	<i>Unit Size Index</i>	<i>P2.1.6 Grid Converter Rated Current (Default)</i>	<i>P2.6.1.1 Current Limit (Default)</i>	<i>P2.6.1.1 Current Limit (Maximum)</i>
18	110	13,5	18,0	27,0
22	120	18,0	22,0	36,0
27	130	22,0	27,0	44,0
34	140	27,0	34,0	54,0
41	150	34,0	41,0	68,0
52	160	41,0	52,0	82,0
62	170	52,0	62,0	104,0
80	190	62,0	80,0	124,0
100	200	80,0	100,0	160,0
125	220	100,0	125,0	200,0
144	230	125,0	144,0	250,0
177	240	144,0	170,0	288,0
205	250	170,0	208,0	300,0
261	260	208,0	261,0	375,0
325	270	261	325	470
385	280	325	385	585
416	290	325	416	585
460	300	385	460	693
502	310	460	502	828
550	315	460	550	828
590	320	502	590	878
650	330	590	650	1062
750	340	650	750	1170
815	345	750	815	1170
820	350	750	820	1170
920	355	820	920	1476
1030	360	820	1030	1476
1030	365	920	1030	1656
1180	370	1030	1180	1755
1300	380	1180	1300	2124
1370	390	1180	1370	2124
1500	400	1300	1500	2340
1700	410	1500	1700	2700
1900	420	1700	1900	3060
1500	990	990	1500	1812

**1.8 DEFAULT CURRENTS OF 500 VAC LIQUID COOLED UNIT**

<i>Converter type Liquid Cooled 500 Vac</i>	<i>Unit Size Index</i>	<i>P2.1.6 Grid Converter Rated Current (Default)</i>	<i>P2.6.1.1 Current Limit (Default)</i>	<i>P2.6.1.1 Current Limit (Maximum)</i>
16	123	12,0	16,0	20,0
22	140	16,0	22,0	27,5
31	150	22,0	31,0	38,8
38	160	31,0	38,0	47,5
45	170	38,0	46,0	57,5
61	180	45,0	61,0	76,3
72	190	61,0	72,0	90,0
87	200	72,0	87,0	108,8
105	210	87,0	105,0	131,3
140	220	105,0	140,0	175,0
168	230	140,0	170,0	212,5
205	240	168,0	205,0	256,3
261	250	205,0	261,0	326,3
300	260	261,0	300,0	375,0
385	270	300	385	481
460	280	385	460	575
520	290	460	520	650
590	300	520	590	738
650	310	590	650	813
730	320	650	730	913
820	330	730	820	1025
920	335	820	920	1150
1030	340	820	1030	1288
1030	345	920	1030	1288
1150	350	1030	1150	1438
1370	360	1150	1370	1713
1640	370	1370	1640	2050
2060	380	1640	2060	2575
2300	390	2060	2300	2875
2643	400	2300	2643	3304
2400	1000	2300	2900	3000

**1.9 DEFAULT CURRENTS OF 690 VAC LIQUID COOLED UNIT**

<i>Converter type Liquid Cooled 690 Vac</i>	<i>Unit Size Index</i>	<i>P2.1.6 Grid Converter Rated Current (Default)</i>	<i>P2.6.1.1 Current Limit (Default)</i>	<i>P2.6.1.1 Current Limit (Maximum)</i>
170	240	144,0	170,0	212,5
208	250	170,0	208,0	260,0
261	260	208,0	261,0	326,3
325	270	261	325	406
385	280	325	385	481
416	290	325	416	520
460	300	385	460	575
502	310	460	502	628
550	315	460	550	688
590	320	502	590	738
650	330	590	650	813
750	340	650	750	938
815	345	750	815	1019
820	350	750	820	1025
920	355	820	920	1150
1030	360	820	1030	1288
1030	365	920	1030	1288
1180	370	1030	1180	1475
1300	380	1180	1300	1625
1370	390	1180	1370	1713
1500	400	1300	1500	1875
1700	410	1500	1700	2125
1900	420	1700	1900	2375
1500	990	990	1500	1812

**1.10 CURRENT SCALING IN DIFFERENT SIZE OF UNITS**

Voltage	Size	Scale
208 – 240 Vac	NX0001 – NX0011	100 – 0.01A
208 – 240 Vac	NX0012 – NX0420	10 – 0.1A
208 – 240 Vac	NX0530	1 – 1A
380 – 500 Vac	NX0003 – NX0007	100 – 0.01A
380 – 500 Vac	NX0009 – NX0300	10 – 0.1A
380 – 500 Vac	NX0385 – NX2643	1 – 1A
525 – 690 Vac	NX0004 – NX0013	100 – 0.01A
525 – 690 Vac	NX0018 – NX0261	10 – 0.1A
525 – 690 Vac	NX0325 – NX1500	1 – 1A

## 2. GRID CODES

### 2.1 GENERAL

In AFE mode Grid Codes are available (Island mode and uGrid mode do not support Grid Codes). To use Grid Codes, OPT-D7 is needed along with P2.17.1 Grid Code license.

OPT-D7 measurement point needs to be on grid side of the MCB (Q1) breaker. Drive needs to be able to see the grid even in stop state while MCB (Q1) is open to operate correctly.

Non Vacon Bus drives can't show OPT-D7 measurements when dc-link is not powered. Contact factory for possibility obtain VB00450 and VB00728.

Grid Codes are enabled with P2.17.3 EnableGridCode selection 2 / Enabled, whole parameter group G2.17 is dedicated for grid code settings, by default, no grid code functionalises area active other than unspecific frequency and voltage level tripping limits.

**NOTE!** Drive Grid Codes are compliant only when drive itself is controlling the MCB. In case of upper system is controlling the breaker, the upper system will need certification.

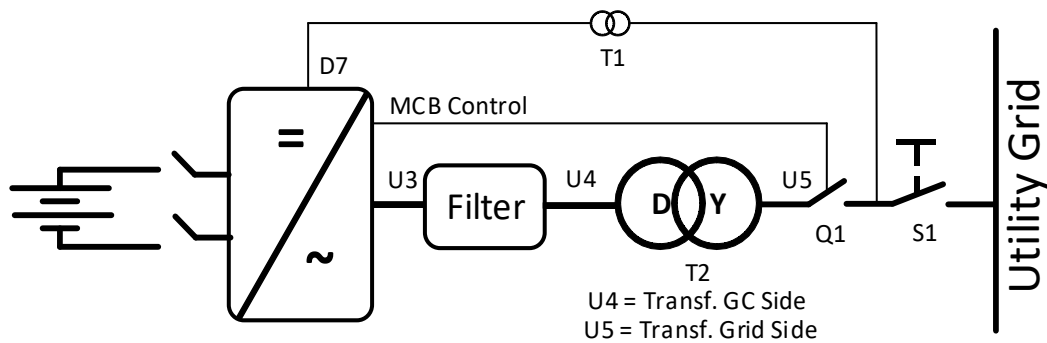

### 3. QUICK START AND OPERATION PRINCIPLES

**NOTE!** Before you start the commissioning, read the safety instructions in the user manual of your product.

To use the Island, Micro Grid, or Shaft generator operation, you need a licence key. The AFE mode is available without a licence.

This application requires an NXP3 control board VB761 or newer.

The control place (P3.1) of the Grid Converter drive is Keypad as a default.

The basic I/O configuration of the Grid Converter drive consists of OPT-A1, OPT-A2, and OPT-D7 option boards. The basic I/O configuration is described in Table 1.

OPT-D7 is required when the Grid Converter unit is needed to start with zero power to the grid. If grid frequency is not monitored with OPT-D7, the unit may go generator side or directly to full power because different reference frequency and grid frequency.

The Grid Converter is utilised by using AFE hardware with special software. An external LC(L)-filter and charging circuit is needed. This unit is selected when low harmonics are required. The principle connection of AFE drive has been described in Figure 4.

The external 24 Vdc is recommended for control board(s). It enables the setting of parameters even when the power unit itself is not powered. This is important also when software updates are made. Some default I/O configuration of the application can cause unexpected DO operation. When the control board is powered, the drive can give information from the status of the system if, for example, the drive I/O is used for an overall system monitoring.

The external 24 Vdc is required for the drives in cases where the start command starts the control board-controlled precharging operation.

#### 3.1 QUICK START INSTRUCTIONS

1. Connect the unit according to the Figure 4.
2. Power up the control unit with 24 Vdc.
3. Set the basic parameters (G2.1)
4. Check that the digital input parameters (G2.4.2) have been set according to the connections.
5. Change the control place according to the system requirements.
6. Charge the unit.

#### 3.2 IN CASE OF PARALLEL AFE:

1. Set P2.1.5 Parallel AFE to *Yes*. This will also set DC Drooping to 3.00% (Default).

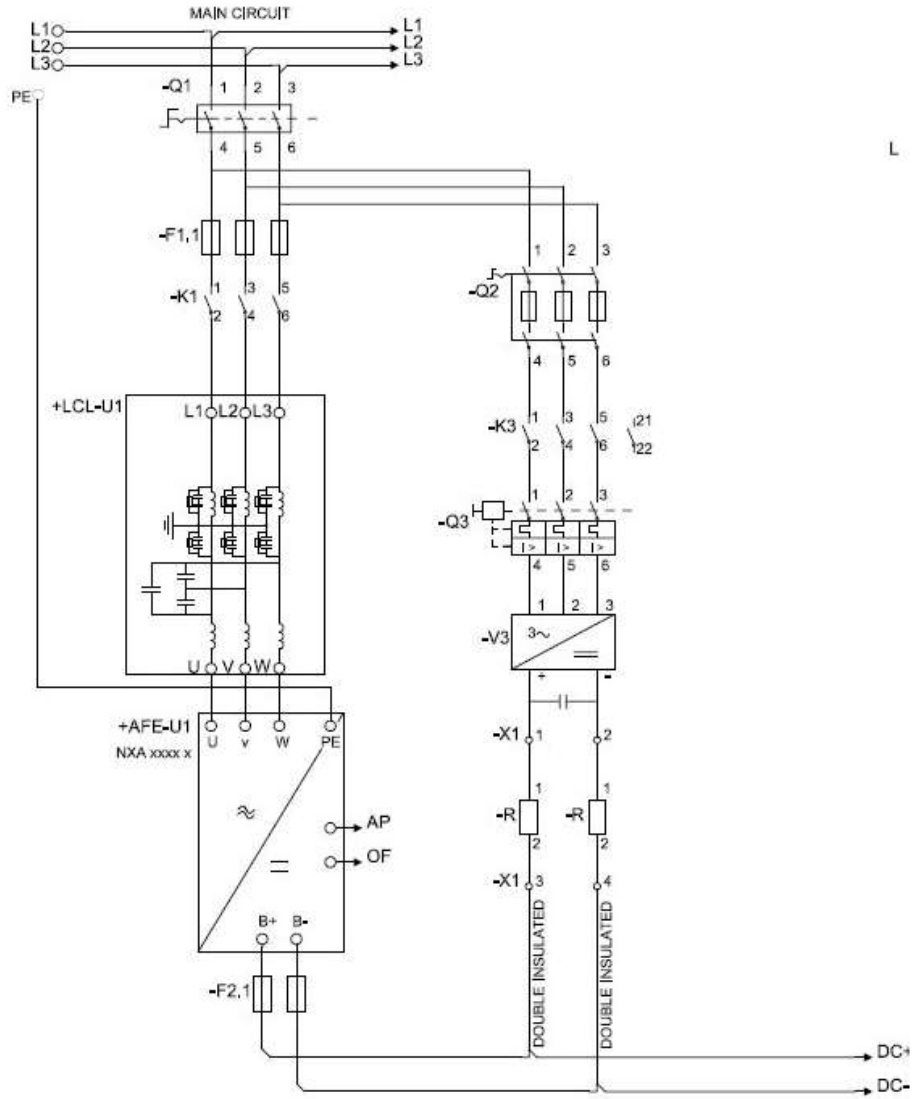

Figure 4. Connection

### 3.3 PRE-CHARGING OF DC

This AFE application has its own charging control, P2.5.1.13 DC Charge (24 Vdc required for control board) and charging protection in case the external charging cannot get DC voltage to required level within set time P2.9.1.5 Charge Max Time (provided that the DC Voltage reaches the under voltage fault level).

The charging function is activated when P2.5.1.13 DC Charge is A.1 or higher. When the control place is IO, Keypad or NCDrive, charging is started from the start command.

Charging is not started if:

- Drive is in fault state.
- P2.4.2.26 Enable CB Close is FALSE
- P2.4.2.8 Run Enable is FALSE
- P2.4.2.19 Quick Stop is FALSE

Charging is also stopped if above conditions occur during charging or if the start command is removed.

For fieldbus control, charging is started with B0 of FB Control Word on the supporting FB profiles. Charging is also stopped if B0 goes low. Also MCB is opened if already closed.

DC Charge (F80) is given if 85 % of DC Nominal is not reached within P2.9.1.5 Charge Max Time and charging is stopped.

DC Charging is stopped when the drive receives feedback from P2.4.2.4 MCB Feedback.

**NOTE!** Use suitably sized DC Charging resistor. To select the correct size, check Pulse loadability for time duration set in for Max Charge Time parameter.



### 3.4 MAIN CIRCUIT BREAKER CONTROL (MCB)

The Grid Converter application controls the circuit breaker of the system with the relay output R02. When the DC bus is charged, the MCB will be closed. The status of the MCB is monitored via a digital input. The digital input used for monitoring is selected with parameter P2.3.1.3. Faults can be set to open the MCB by selecting a response to a fault to be *3=Fault, DC OFF*.

An external charging circuit is necessary to charge the DC bus but drive can control this circuit if 24 Vdc is provided for the control board.

Closing limit is 85% of the System Nominal DC Voltage (P2.1.7).

System Nominal DC Voltage for the Grid Converter is adjusted with System Nominal DC parameter P2.1.7 ID1805.

Over Current (F1), Hardware IGBT (F31) and Software IGBT (F41) faults will open MCB immediately to protect the drive.

For Grid Code use its recommended to have breaker that mechanical opening delay is less than 30 ms when clearing times are less than 200 ms also use early brake auxiliary contact as accessory to breaker of contact.

**NOTE!** Drive Grid Codes are compliant only when drive itself is controlling the MCB.

**NOTE!** The MCB feedback is necessary for the correct operation of the Grid Converter application.

**NOTE!** Only the drive controls its own MCB. If additional interlocks or opening commands are needed, these commands must go through the drive.

**NOTE!** UPS may be needed during short circuit situation to keep MCB closed if control voltage is taken from the grid where the short circuit occurs.

**NOTE!** Missing feedback signal prevent drive going to ready state. MCB Feedback can be monitored from Status Word B10.

**NOTE!** If feedback is not used there will be three second forced delay on internally generated MCB feedback signal. MCB Feedback can be monitored from Status Word B10.

### 3.5 START SEQUENCE

In uGrid mode synchronization to main is done also but if grid is not found drive will make the grid. In Island mode drive will make the grid immediately without synchronization to the grid.

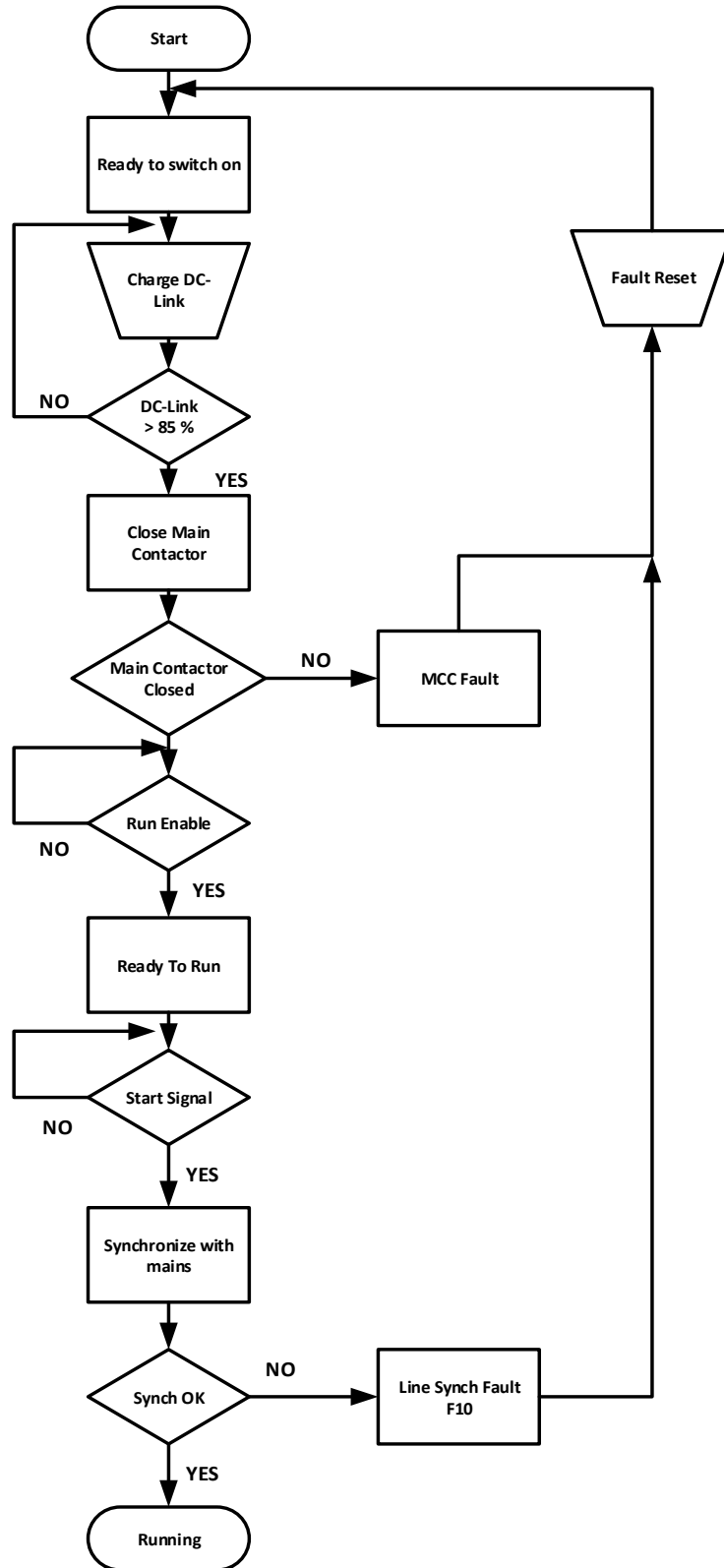

Figure 5. AFE start sequence

## 3.6 STOP SEQUENCE

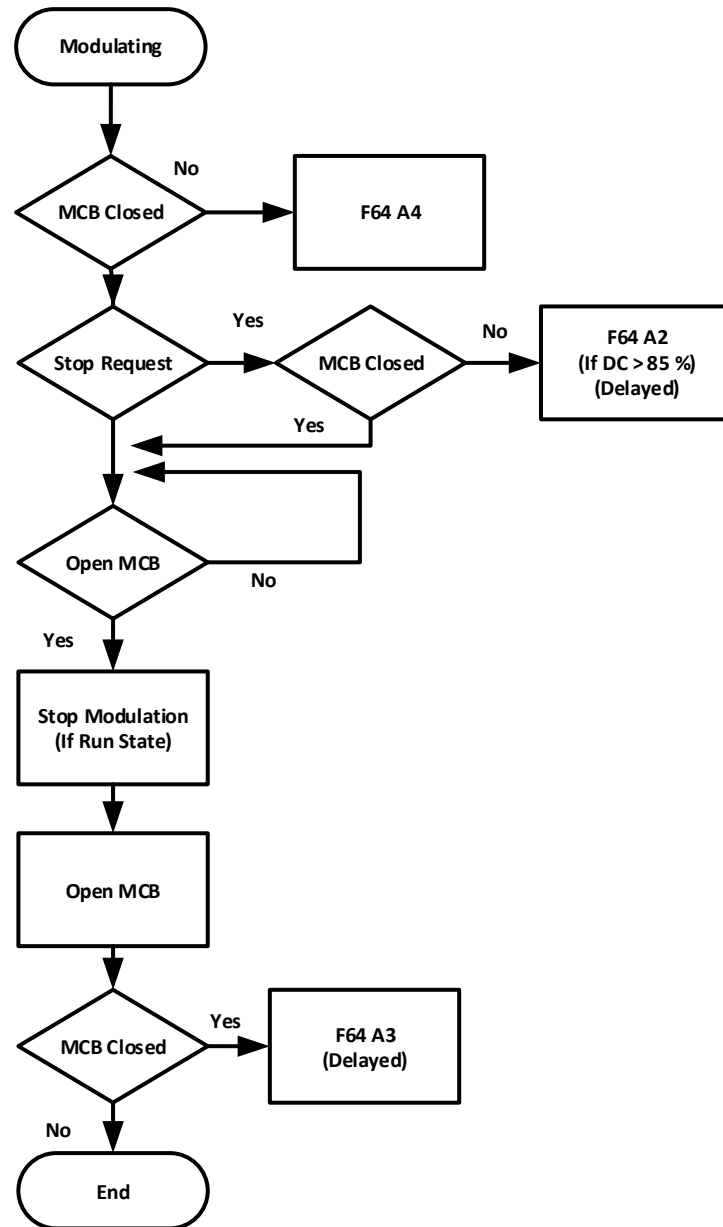
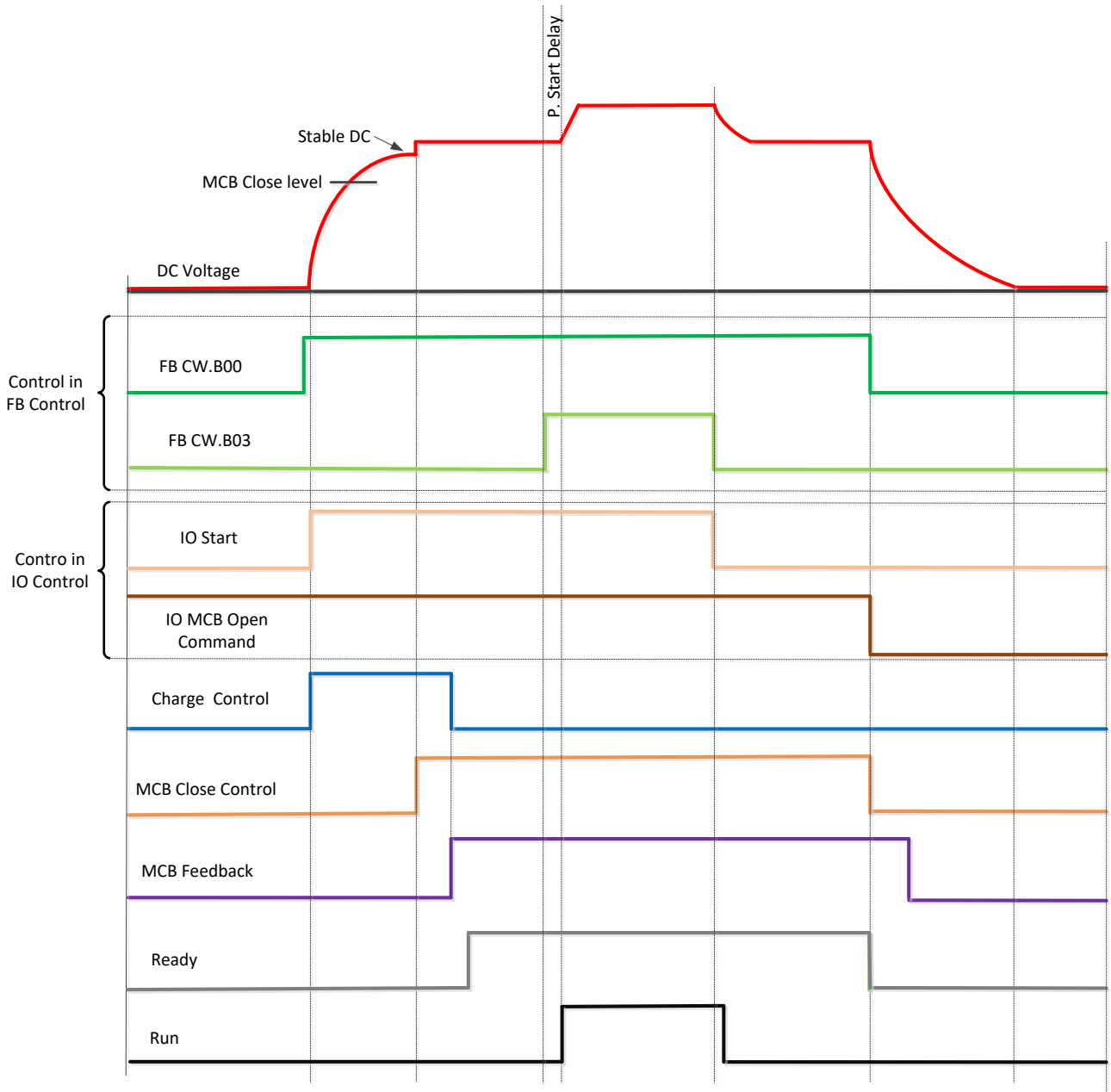

Figure 6. Stop sequence

### 3.7 START STOP TIMING DIAGRAM



Above example when "Standard" state machine is used. With "Basic" state machine operation is like in IO Control.

3.8 START STOP TIMING DIAGRAM WITH GRID CODES

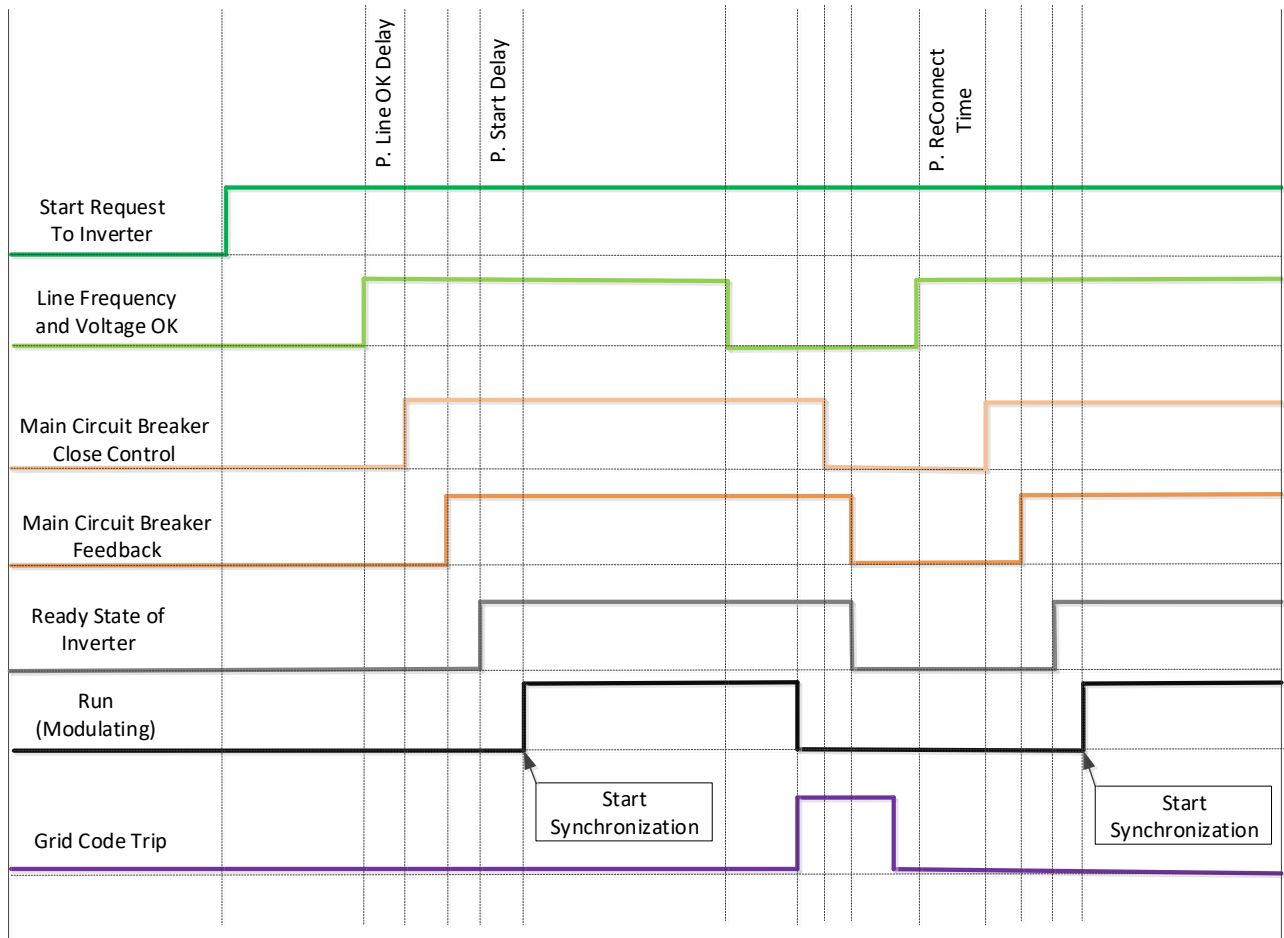

Note: Drive needs to see grid withing OK limits for voltage and frequency before MCB is closed and drive started.

Non Vacon Bus drives can't show OPT-D7 measurements when dc-link is not powered. Contact factory for possibility obtain VB00450 and VB00728.

### 3.9 OPERATION PRINCIPLE: DROOP SPEED CONTROL MODE

When the power demand increases, all generators on the grid allow frequency to droop. This will balance the load between all the generators on the grid. Then the power management system gives all generators a command to increase frequency so that the grid frequency is maintained at its nominal value.

When the load is reducing on the grid, the frequency of the generators will increase, and the power management system gives a command to decrease frequency.

$$FreqOut = GridNomFreq + FreqOffset + \frac{ActiveCurrent}{SystemRatedCurrent} * (-FrequencyDroop)$$

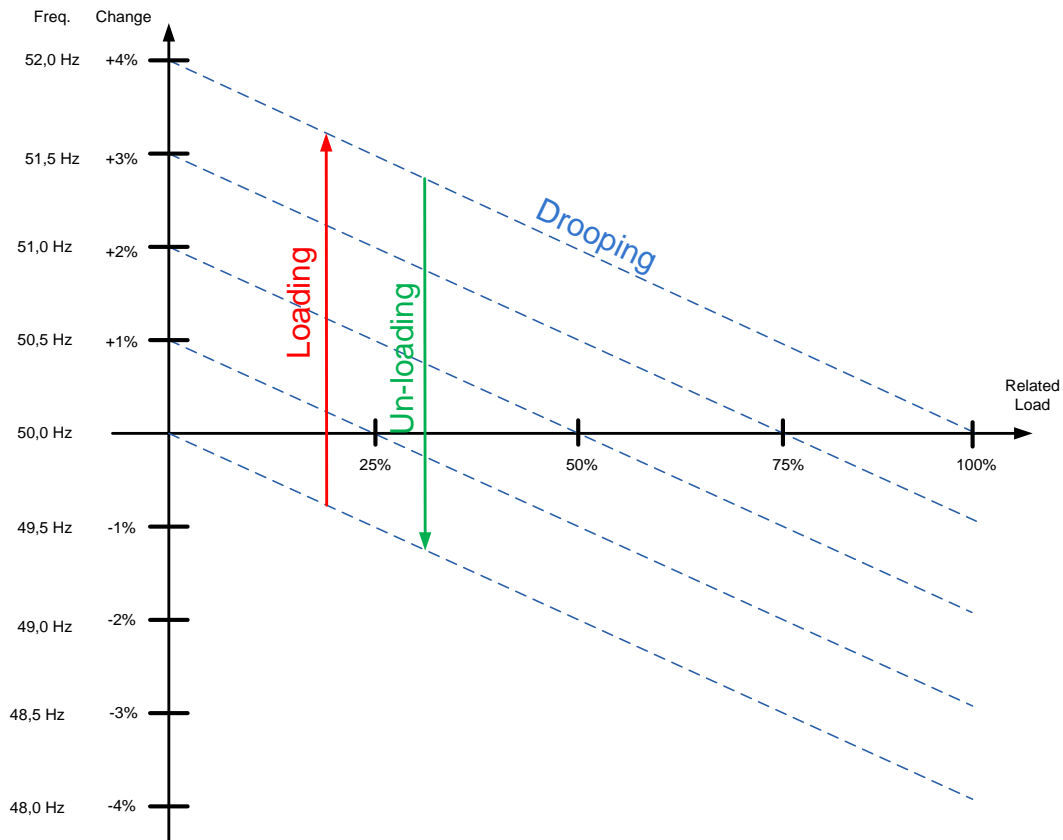

Figure 7.

### 3.10 OPERATION PRINCIPLE: ISOCHRONOUS CONTROL MODE

In the isochronous control mode, the Micro Grid frequency reference is kept the same as the grid frequency with help of OPT-D7. This will keep power at zero regardless of grid frequency. While drive operates in drooping mode, the actual power is controlled by base current reference. This reference needs to be controller by power management system (PMS) that will handle power sharing between different machines on the grid.

### 3.11 VOLTAGE COMPENSATION

Grid Converter system will have voltage losses. Depending on the system, the losses may be more than 50 Vac when operating close to Grid Converter nominal currents with low power factor between points U3 and U5. This voltage loss needs to be compensated so that the grid voltage stays at nominal. This also sets requirements for the needed DC link voltage.

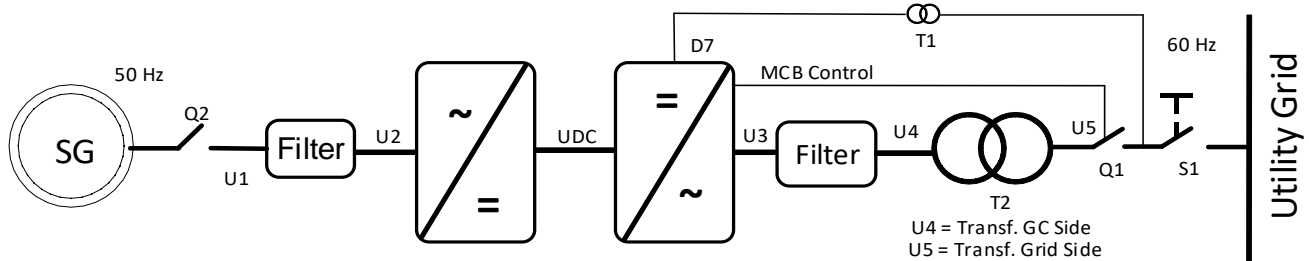

Figure 8. Voltage compensation

The normal operation voltage range in a land-based grid is usually between 80% and 115% of the grid nominal voltage.

The voltage losses compensation is handled separately for Active power (kW) and Reactive power (kVar), the latter being more significant. The Active power voltage losses are compensated with Inductor Losses parameter (P2.2.6.6) and Reactive power voltage losses are compensated with Inductor Size parameter (P2.2.6.5).

Uncompensated system may result in unnecessary reactive power circulation in a grid between the different power sources and wrong grid voltage.

OPT-D7 can be used to compensate the voltage losses (closed loop voltage compensation) but it is recommended to do an open loop voltage compensation tuning in case of OPT-D7 failure. When the OPT-D7 measurements exceed the set limit values, the voltage compensation falls back to open loop control.

#### Inductor Size and Losses affect

Grid Nom. Voltage: 400 Vac, Reactive Current: 30%, Active Current 50%, Inductor Size: 15%, Inductor Losses: 15%, Voltage Correction: 0 Vac.

Reactive Increase:  $400 \text{ Vac} \times 30\% \times 15\% = 18 \text{ Vac}$   
 Active Increase:  $400 \text{ Vac Increase or Losses: } 15\% \times 400 \text{ Vac} \times 50\% \times 15\% \times 15\% = 4.5 \text{ Vac}$   
 Total increase:  $18 \text{ Vac} + 4.5 \text{ Vac} = 22.5 \text{ Vac}$

See also chapter 11.1.

See also electrification training video: How to tune Grid Converter open loop voltage compensation?

### 3.12 OPT-D7 VOLTAGE MEASUREMENT OPTION BOARD

OPTD7 is an AC sinusoidal voltage measurement board. Using this board, the drive measures the line voltage, the frequency and the voltage angle information.

Grid Codes cannot be used or activated without correctly connected OPT-D7 board and Grid Code functionality is only available when drive is operating in AFE mode.

Measurement accuracies of OPT-D7 board

Frequency Accuracy:  $\pm 0,05$  Hz

Voltage Accuracy:  $\pm 2,5\%$  from 690 Vac

The drive can compare this information with its output voltage angle when it runs. This feature can be used to make synchronisations to a grid that is measured. For example, for line synchronisation purposes you can use APFIF44 LineSynch II Application. That will work as a smooth starter.

In Grid Converter application this can be used:

- To synchronise to existing external grid while the drive is running to enable bumpless transfer from a generator operation to a shore powered operation in a ship.
- To control the grid voltage (Voltage losses compensation).
- To enable a zero power connection to an existing grid.
- To help in the commissioning of drive active power and reactive power voltage losses compensation when the actual grid voltage is visible in NCDrive.

The OPT-D7 board is delivered with a measurement transformer (690 :11,5) which is suitable for a voltage range up to 690 Vac. The measurement transformer cannot be connected directly to drive output terminal since it can't measure pulse width modulated (PWM) voltage input.

It is possible to use a customised transformer when the input voltage to be measured is not within the OPT-D7 transformer voltage range. The transformation ratio parameter can be adjusted according to the transformer primary to secondary ratio. See details in the OPT-D7 user manual.

Synchronisation to the grid can be made without the OPT-D7 when the drive operates in the AFE or the Micro Grid mode. This requires that the output terminals of the drive are connected to the existing grid when the drive is in the STOP state. When a start command has been given in AFE or Micro Grid mode, the drive will make standard AFE synchronisation. Depending on the operation mode, the drive will start to keep constant DC voltage (AFE) or start to share power based on grid frequency (Micro Grid). Using OPT-D7 for synchronisation will make the start of the drive smoother.

If the drive does not detect an existing line voltage or frequency in Micro Grid mode, the output voltage is raised defined time (VoltageRiseTime). In the Island mode, the detection of the grid is not made and the voltage is raised from zero in the set time (VoltageRiseTime).

Non Vacon Bus drives can't show OPT-D7 measurements when dc-link is not powered. Contact factory for possibility obtain VB00450 and VB00728.

**NOTE:** The OPT-D7 board (in slot C) is mandatory for the Grid Converter unit.



### 3.13 MASTER FOLLOWER

#### 3.13.1 GENERAL

In master follower modes master is sending control word and DC Voltage reference to follower drives. Follower drives send a status word to master including some command see details from monitoring values description.

- Start command is synchronized
- Master sends run request to followers when all drives indicates that MCB is closed.
  - Status is monitored even if follower do not have own MCB or status from the MCB.
- If any of the drive goes state where MCB is needed to open all drives will open the MCB.
- Control signals to follower drives
  - DC voltage reference, can be selected in follower drive if used master or own reference.

#### 3.13.2 GRID CONVERTER STANDARD MASTER FOLLOWER

In standard master follower mode modulation is not synchronized in any way through system bus communication. This mode can be used when all the units can work independently but e.g. start and DC-Link voltage reference is only wanted to give master drive and only four units are needed for parallel operation.

- 3-LCL-filters are needed to use
- Up to 4 parallel units.

#### 3.13.3 GRID CONVERTER DRIVESYNCH

In DriveSynch master follower modulation is synchronized between the drives, basically all follower will do exactly what master will do.

- 3-pole LC-filters or standard sine-filters can be used instead of LCL-filters when common point is connected to transformer.
- Up to 4 parallel units.

#### 3.13.4 GRID CONVERTER D2-SYNCH

In D2-Synch each unit operate independently only modulation switching is synchronised to eliminate rotating currents.

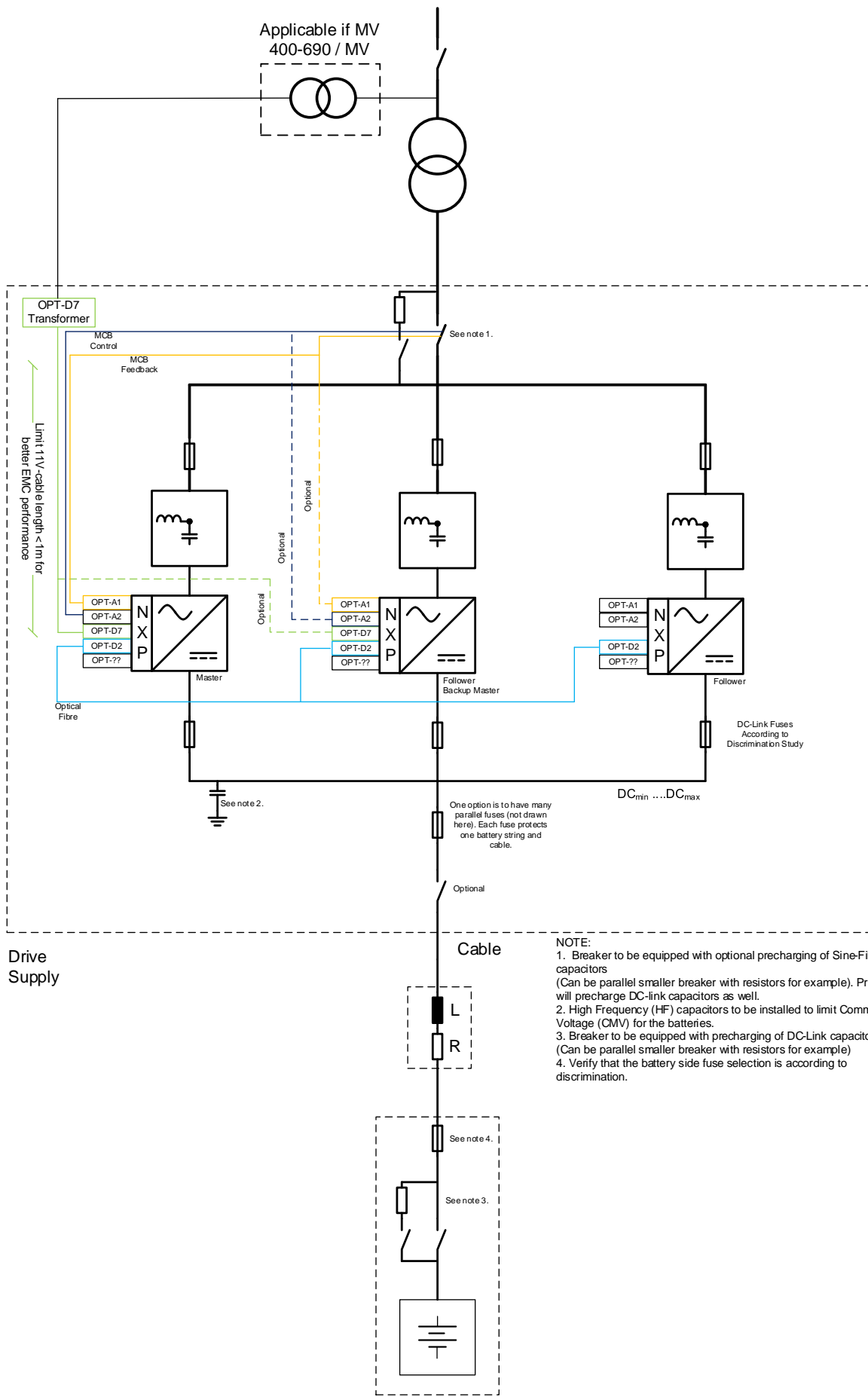

- NOTE:
1. Breaker to be equipped with optional precharging of Sine-Filter capacitors (Can be parallel smaller breaker with resistors for example). Precharge will precharge DC-link capacitors as well.
  2. High Frequency (HF) capacitors to be installed to limit Common Mode Voltage (CMV) for the batteries.
  3. Breaker to be equipped with precharging of DC-Link capacitors (Can be parallel smaller breaker with resistors for example)
  4. Verify that the battery side fuse selection is according to discrimination.

### 3.14 SCALING HIGH VOLTAGES FOR THE GRID CONVERTER

In below case where grid voltage is 8000 Vac, it's needed make some scaling. Important is to get U4 voltage to correct level (500 Vac because T2 transformer ratio) and voltage that OPT-D7 sees (U2) is below 690 Vac, this U2 voltage is used as grid reference voltage.

In below example T3 ratio is 600V/8000V, ratio can be selected freely, as long as U2, grid reference voltage will be below 690 Vac.

T2 is selected as 500V/8000V, ratio needs to be selected so that drive terminal voltage will be within drive operational limits.

T3 low voltage level is set as grid nominal voltage and transformer grid side voltage:

T3 = 600V/8000V -> P2.1.1 Grid Nom Voltage: 600 Vac -> P2.1.10 Transf. Grid Side: 600 Vac

T2 low voltage level is set as transformer grid converter side voltage (U4):

T2 = 500V/8000V -> P2.1.9 Transf. GC Side: 500 Vac

T1 is OPT-D7 own transformer that is delivered when OPT-D7 is ordered, parameter is by default 60.

T1 = OPT-D7 own = 11,5/690 = P7.3.1.1 Transformer Ratio: 60,00

Then V1.1.14 AC Voltage Reference will be 500 Vac (No load voltage reference for U4)

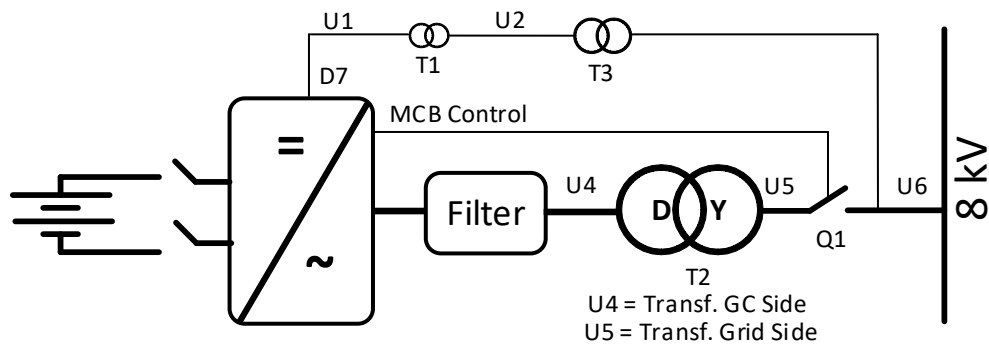

If OPT-D7 own transformer is not used, make sure than OPT-D7 option board never sees above 14 Vrms, with own transformer this equals to 840 Vac. See details from OPT-D7 option board manual.



## 4. CONTROL I/O

### 4.1 SLOT A AND SLOT B TERMINALS

Table 1. Minimum recommended I/O configuration.

OPT-A1			
Terminal		Signal	Description
1	+10V <sub>ref</sub>	Reference voltage output	Voltage for potentiometer, etc.
2	AI1+	Analogue input 1. Range 0-10V, R <sub>i</sub> = 200Ω Range 0-20 mA R <sub>i</sub> = 250Ω	Input range selected by jumpers. Default range: Voltage 0 – 10 V
3	AI1-	I/O Ground	Ground for reference and controls
4	AI2+	Analogue input 2. Range 0-10V, R <sub>i</sub> = 200Ω Range 0-20 mA R <sub>i</sub> = 250Ω	Input range selected by jumpers. Default range: Current 0 – 20 mA
5	AI2-		
6	+24V	Control voltage output	Voltage for switches, etc. max 0.1 A
7	GND	I/O ground	Ground for reference and controls
8	DIN1	Programmable G2.2.1	
9	DIN2	Programmable G2.2.1	
10	DIN3	Programmable G2.2.1	
11	CMA	Common for DIN 1– DIN 3	Connect to GND or +24V
12	+24V	Control voltage output	Voltage for switches (see #6)
13	GND	I/O ground	Ground for reference and controls
14	DIN4	MCB Feedback Programmable G2.2.1	0 = MCB open 1 = MCB closed
15	DIN5	Quick Stop Programmable G2.2.1	0 = Quick Stop Active 1 = No Quick Stop
16	DIN6	Programmable G2.2.1	
17	CMB	Common for DIN4– DIN6	Connect to GND or +24V
18	AO1+	Analogue output 1	Programmable Range 0– 20 mA/R <sub>L</sub> , max. 500Ω
19	AO1-		
20	DO1	Digital output READY	Programmable P2.3.1.1 Open collector, I <sub>s</sub> ≤50mA, U <sub>s</sub> ≤48 VDC
OPT-A2			
21	RO1	 Relay output 1 Programmable P2.3.1.2	Switching capacity 24 VDC / 8 A 250 VAC / 8A 125 VDC / 0.4 A
22	RO1		
23	RO1		
24	RO2	 Relay output 2 MCB control	<b>This RO is not programmable. Fixed for MCB Control (Close)</b>
25	RO2		
26	RO2		

### 4.2 TERMINAL TO FUNCTION (TTF)

The programming principle of the input and output signals in the Grid Converter Application is different compared to the conventional method used in other VACON® NX applications.

In the conventional programming method, Function to Terminal Programming Method (FTT), you have a fixed input or output that you define a certain function for. The applications mentioned above, however, use the Terminal to Function Programming method (TTF) in which the programming process is carried out the other way round: Functions appear as parameters which the operator defines a certain input/output for.

#### 4.1 DEFINING INPUTS AND OUTPUTS

Connecting a certain input or output with a certain function (parameter) is done by giving the parameter an appropriate value. The value is formed of the Board slot on the VACON® NX control board (see VACON® NX User Manual) and the respective signal number, see below.

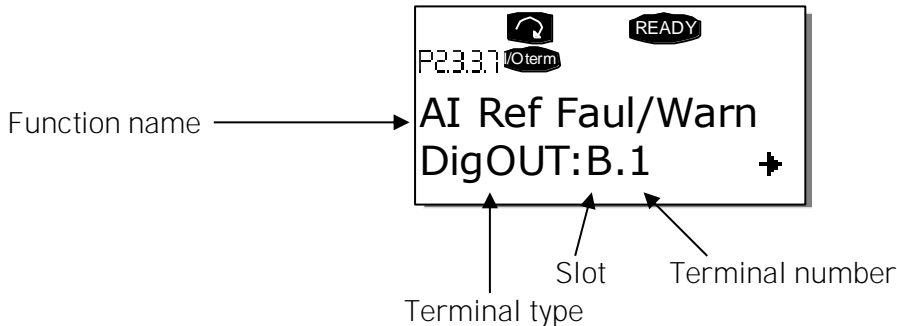

**Example:** You want to connect the digital output function Reference fault/warning (parameter 2.3.3.7) to the digital output DO1 on the basic board NXOPTA1 (see VACON® NX User Manual).

First find the parameter 2.3.3.7 on the keypad. Press the Menu button right once to enter the edit mode. On the value line, you will see the terminal type on the left (DigIN, DigOUT, An.IN, An.OUT) and on the right, the present input/output the function is connected to (B.3, A.2 etc.), or if not connected, a value (0.#).

When the value is blinking, hold down the Browser button up or down to find the desired board slot and signal number. The program will scroll the board slots starting from 0 and proceeding from A to E and the I/O selection from 1 to 10.

Once you have set the desired value, press the Enter button once to confirm the change.

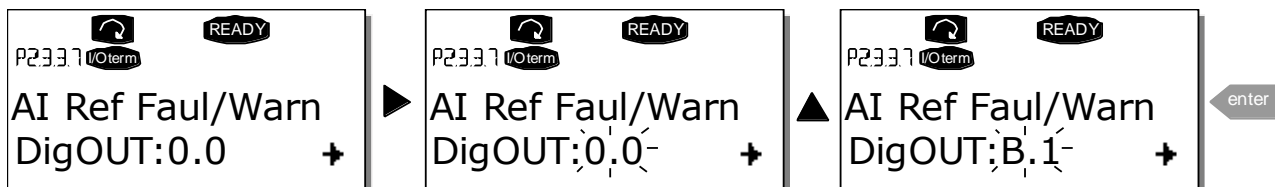

### 4.1 DEFINING A TERMINAL IN NCDRIVE

If you use the VACON® NCDrive Programming Tool for parametrizing you will have to establish the connection between the function and input/output in the same way as with the control panel. Just pick the address code from the drop-down menu in the Value column (see the Figure below).

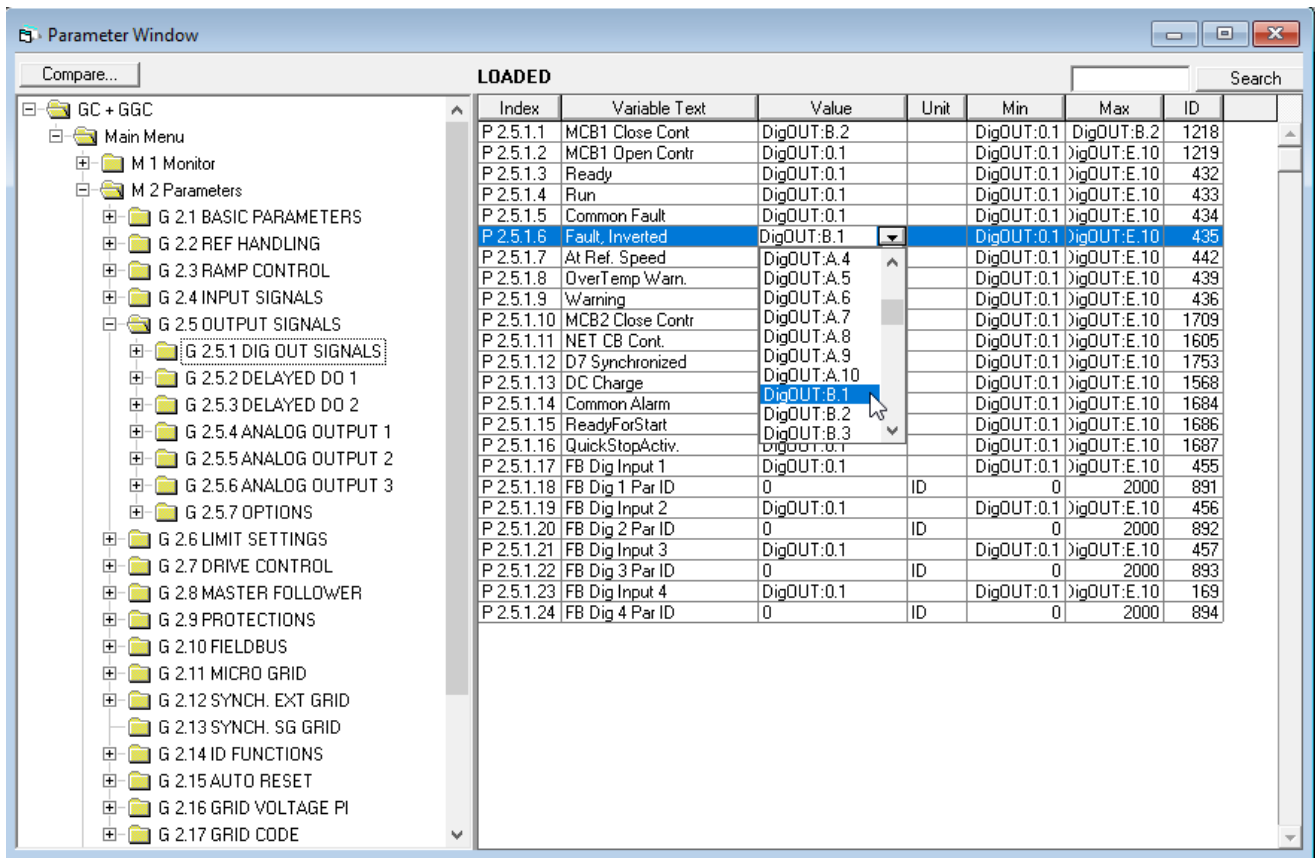

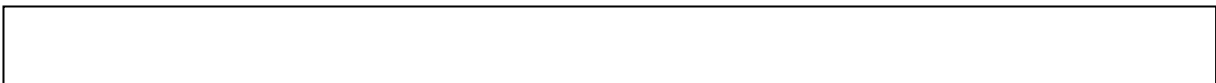

Figure 3 1. Screenshot of NCDrive programming tool; Entering the address code



 <b>WARNING</b>	Be <b>ABSOLUTELY</b> sure not to connect two functions to one and same <u>output</u> in order to avoid function overruns and to ensure flawless operation.
---	--



## 5. MONITORING SIGNALS

The menu M1 (Monitoring) has all the monitoring values.

### Column explanations:

Code	= Location indication on the keypad; Shows the operator the present parameter number
Parameter	= Name of parameter
Min	= Minimum value of parameter
Max	= Maximum value of parameter
Unit	= Unit of parameter value; Given if available
Default	= Value preset by factory
Cust	= Customer's own setting
ID	= ID number of the parameter
	= On parameter code: Parameter value can only be changed after the FC has been stopped.
	= Apply the Terminal to Function method (TTF) to these parameters.
	= Monitoring value is possible to control from fieldbus by ID number

The manual presents signals that are not normally visible for monitoring. i.e. is not a parameter or standard monitoring signal. These signals are presented with [Letter]. e.g.

[FW]MotorRegulatorStatus

- [V] Normal monitoring signal
- [P] Normal parameter in application.
- [FW] Firmware signal, Can be monitored with VACON® NCDrive when signal type is selected  
Firmware
- [A] Application signal, can be monitored with VACON® NCDrive when signal type is selected  
Application.
- [R] Reference type parameter on keypad.
- [F] Function. Signal is received as a output of function.
- [DI] Digital input signal.

## 5.1 MONITORING VALUE TABLES

### 5.1.1 MONITORING VALUES 1

Code	Parameter	Unit	Form.	ID	Description
V1.1.1	DC-Link Voltage	V	#	1108	Measured DC Link voltage in volts, filtered.
V1.1.2	DC Voltage Ref.	%	#,##	1200	Used DC voltage reference by the regenerative unit in % of Nominal DC voltage. Nominal DC voltage = 1.35 * supply voltage
V1.1.3	DC Voltage Act.	%	#,##	7	Same scaling as DC Voltage Ref.
V1.1.4	Total Current	A	Varies	1104	Filtered current
V1.1.5	Active Current	%	#, #	1125	> 0 power from AC side to DC side < 0 power from DC side to AC side
V1.1.6	Reactive Current	%	#, #	1157	> 0 decreases voltage < 0 increases voltage
V1.1.7	Power kW	kW	Varies	1508	> 0 power from AC side to DC side < 0 power from DC side to AC side
V1.1.8	Power %	%	#, #	5	> 0 power from AC side to DC side < 0 power from DC side to AC side
V1.1.9	Status Word		#	43	Essential status information from the drive.
V1.1.10	Supply Frequency	Hz	#,##	1	Drive output frequency
V1.1.11	Supply Voltage	V	#, #	1107	Drive output voltage
V1.1.12	Line Frequency D7	Hz	#,##	1654	Measured line frequency
V1.1.13	Line Voltage D7	V	#	1650	Measured line voltage
V1.1.14	AC Voltage Reference	V	#	1556	Used AC Voltage Reference
V1.1.15	DC Ref Max Lim	%	#,##	1606	Internal limit for DC Voltage Ref.
V1.1.16	Non Ready Cause		#	1661	
V1.1.17	Prevent MC Ready		#	1609	
V1.1.18	Status Word 2		#	89	



## 5.1.2 MONITORING VALUES 2

Code	Parameter	Unit	Form.	ID	Description
V1.2.1	DC Voltage	V	#	44	Measured DC Link voltage in volts, unfiltered.
V1.2.2	Operation Mode		#	1615	0 = AFE 1 = Island 2 = Micro Grid
V1.2.3	Used Current Ref	%	#, #	1704	Used current reference is negated to parameter value. Made to compare values in NCDrive easier to Active current
V1.2.4	D7 Synch. Error		#	1659	Synchronisation error to external grid
V1.2.5	Cos Phi Actual		#,###	1706	
V1.2.6	Unit Temperature	°C	#	1109	
V1.2.7	Freq. Reference	Hz	#, #	1752	Used line frequency reference
V1.2.8	Current	A	Varies	1113	Unfiltered current
V1.2.9	Operation Hours	h	#, ##	1856	
V1.2.10	Reactive Current Reference	%	#, #	1389	
V1.2.11	Grid State		#	1882	
V1.2.12	Mindex	%	#, #	1874	Modulation Index
V1.2.13	IU rms	A	Varies	39	
V1.2.14	IV rms	A	Varies	40	
V1.2.15	IW rms	A	Varies	41	
V1.2.16	DC-Link Current	A	Varies	72	
V1.2.17	DC-Link ActCurr	%	#, #	1158	
V1.2.18	Iq Actual	%	#, #	4	Filtered by P2.17.16.11
V1.2.19	Id Actual	%	#, #	1134	

## 5.1.3 FIELDBUS MONITORING VALUES

Code	Parameter	Unit	Form.	ID	Description
V1.3.1	FB Control Word		#	1160	Control word from fieldbus
V1.3.2	FB Status Word		#	68	Status word to fieldbus
V1.3.3	Fault Word 1		#	1172	
V1.3.4	Fault Word 2		#	1173	
V1.3.5	Warning Word 1		#	1174	
V1.3.6	FB Micro Grid CW1		#	1700	Control for Micro Grid operations
V1.3.7	FB Micro Grid SW1		#	1701	Status of Micro Grid operations
V1.3.8	Last Active Warning		#	74	
V1.3.9	Last Active Fault		#	37	
V1.3.10	MC Status		#	64	
V1.3.11	FB Analogue Out	%	#, ##	48	

## 5.1.4 I/O MONITORING VALUES

Code	Parameter	Unit	Form.	ID	Description
V1.4.1	DIN1, DIN2, DIN3		#	15	
V1.4.2	DIN4, DIN5, DIN6		#	16	
V1.4.3	DIN Status 1		#	56	
V1.4.4	DIN Status 2		#	57	
V1.4.5	Analogue Input 1	%	#,##	13	
V1.4.6	Analogue Input 2	%	#,##	14	
V1.4.7	Analogue input 3	%	#,##	27	AI3, unfiltered.
V1.4.8	Analogue input 4	%	#,##	28	AI4, unfiltered.
V1.4.9	Analogue Out 1	%	#,##	26	
V1.4.10	Analogue Out 2	%	#,##	50	AO2
V1.4.11	Analogue Out 3	%	#,##	51	AO3
V1.4.12	PT100 Temp	°C	#,.	42	Maxim temperature
V1.4.13	PT100 Temp. 1	°C	#,.	50	
V1.4.14	PT100 Temp. 2	°C	#,.	51	
V1.4.15	PT100 Temp. 3	°C	#,.	52	
V1.4.16	PT100 Temp. 4	°C	#,.	69	
V1.4.17	PT100 Temp. 5	°C	#,.	70	
V1.4.18	PT100 Temp. 6	°C	#,.	71	

## 5.1.5 MASTER / FOLLOWER

Code	Parameter	Unit	Form.	ID	Description
V1.5.1	SB SystemStatus		#	1819	
V1.5.2	Master CW		#	93	
Code	Parameter	Unit		ID	Description
V1.5.3.1	Current D1	A	Varies	1820	
V1.5.3.2	Current D2	A	Varies	1821	
V1.5.3.3	Current D3	A	Varies	1822	
V1.5.3.4	Current D4	A	Varies	1823	
Code	Parameter	Unit		ID	Description
V1.5.4.1	Status Word D1		#	1828	
V1.5.4.2	Status Word D2		#	1829	
V1.5.4.3	Status Word D3		#	1830	
V1.5.4.4	Status Word D4		#	1831	

## 5.1.6 LICENCE ACTIVATION STATUS

Code	Parameter	Unit	Form.	ID	Description
V1.6.1	Serial Number Key		#	1997	Give this number to the technical support of the manufacturer in case of licence key problems.
V1.6.2	Licence uGrid		#	1996	
V1.6.3	Licence Grid Code		#	1993	

**5.1.7 GRID CODE**

Code	Parameter	Unit	Form.	ID	Description
V1.7.1	Grid Code State		#	2203 3548	
V1.7.2	Line State		#	2202 3547	
V1.7.3	Line Voltage GC	%	#,##	1912	Line Voltage used by Grid Code
V1.7.4	Line Frequency GC	%	#,##	1913	Line Frequency used by Grid Code
V1.7.5	Line Voltage GC2	%	#,##	4500	
V1.7.6	Line Freq. GC0	%	#,##	4501	
V1.7.7	Line Voltage L1-L2	%	#,##	3203	
V1.7.8	Line Voltage L2-L3	%	#,##	3204	
V1.7.9	Line Voltage L3-L1	%	#,##	3205	
V1.7.10	Trip State		#	2206 3549	
V1.7.11	PosSeqVoltage	V	#, #	3511	
V1.7.12	NegSeqVoltage	V	#, #	3512	
V1.7.13	NewSeqCurrent	%	#, #	3513	

**5.1.8 PI POWER CONTROLLER**

Code	Parameter	Unit	Form.	ID	Description
V1.8.1	PID Reference		#, #	20	Base Current Ref in AFE mode
V1.8.2	PID Actual Value		#, #	21	
V1.8.3	PID Output		#, ##	23	

**5.1.9 ACTIVE LIMITS**

Code	Parameter	Unit	Form.	ID	Description
V1.9.1	Output Power Limit	%	#, #	1953	
V1.9.2	Input Power Limit	%	#, #	1952	
V1.9.3	Current Limit	A	Varies	1954	

**5.1.10 LINE MONITORING**

Code	Parameter	Unit	Form.	ID	Description
V1.10.1	Line Voltage D7	V	#	1650	Measured line voltage
V1.10.2	Line Frequency D7	Hz	#, ##	1654	Measured line frequency
V1.10.3	Line Voltage THD	%	#, ##	1670	
V1.10.4	LineVoltageHFrms	V	#, #	1671	
V1.10.5	LineVoltage D7.1	V	#, #	4503	
V1.10.6	Active Power D7	%	#, #	4504	
V1.10.7	Reactive Power D7	%	#, #	4505	

## 5.2 DESCRIPTION OF MONITORING VALUES

### 5.2.1 MONITORING 1 VALUES

#### V1.1.1 *DC-Link Voltage V* ID1108

The measured DC voltage, filtered.

#### V1.1.2 *DC Voltage Ref. %* ID1200

The DC voltage reference. Compared to given System Nominal DC parameter.

#### V1.1.3 *DC Voltage Act. %* ID7

The actual DC Voltage, measured DC Voltage scaled to % value.  
Percentage value of System Nom. DC.

#### V1.1.4 *Total Current A* ID 1104

The filtered current of the drive.

#### V1.1.5 *Active Current %* ID 1125

The active current in % of Grid Converter Rated Current.  
Active Current > 0: Current flow from AC-Side to Drive DC-Link.  
Active Current < 0: Current flow from Drive DC-Link to AC-Side.

#### V1.1.6 *Reactive Current %* ID 1157

The reactive current of the regenerative drive in % of Grid Converter Rated Current.  
Reactive Current > 0: Decreases voltage  
Reactive Current < 0: Increases voltage

#### V1.1.7 *Power kW[kW]* ID 1508

The output power of the drive in kW.  
Power kW > 0: Current flow from AC-Side to Drive DC-Link.  
Power kW < 0: Current flow from Drive DC-Link to AC-Side.

#### V1.1.8 *Power % [%]* ID 5

The output power of the drive in %. 100,0 % equals 100.0 % Active Current and 100.0 % Supply Voltage.  
Power > 0: Current flow from AC-Side to Drive DC-Link.  
Power < 0: Current flow from Drive DC-Link to AC-Side.

**V1.1.9 Status Word (Application) ID 43**

The Application Status Word combines different statuses of the drive to one data word.

Status Word (Application) ID43		
	FALSE	TRUE
b0	Charging Control Not Active	Charging Control Active
b1	Not in Ready state	Ready
b2	Not Running	Running
b3	No Fault	Fault
b4	No Start Request	Start Request
b5	Quick stop active	Quick stop not active
b6	Run Disabled	Run Enable
b7	No Warning	Warning
b8	Charging Switch Open	Charging Switch closed (internal)
b9	MCB Control Open	MCB Control
b10	MCB Feedback; Open	MCB Feedback; Closed
b11	Short Circuit Mode Not Active	Short Circuit Mode Active
b12	No Run Request	Run Request
b13	Not At Current Limit	At Current Limit
b14	AFE Mode Active	Island Mode Active
b15		uGrid Mode Active

**V1.1.10 Supply Frequency Hz ID 1**

The drive output frequency. Updated in the STOP state when AFE Options 1 B9 is activated.

**V1.1.11 Supply Voltage V ID 1107**

The drive output voltage.

**V1.1.12 Line Frequency D7 Hz ID 1654**

The measured line voltage frequency when using the OPT-D7 option board in slot C.

**V1.1.13 Line Voltage D7 V ID 1650**

The measured line voltage rms value when using the OPT-D7 option board in slot C.

**V1.1.14 AC Voltage Reference V ID1556**

The used AC voltage reference.

**V1.1.15 DC Voltage Max Limit ID1606**

The drive will limit the DC reference to inside drive specification, but allows higher reference if lower supply voltage. This shows the final limit of the DC reference.

### V1.1.16 *Non Ready Cause* # 1661

Gives reason why drive is not in ready state.

Non Ready Cause ID1661	
	Signal
b0	Fault is Active
b1	PreventMCReady is set See V1.1.17 Prevent MC Ready ID1609
b2	Charge switch is open
b3	DC Voltage not OK
b4	Power unit state not OK
b5	StartUp Wizard is active
b6	Run Enable is not set
b7	Ready state prevented by STO
b8	
b9	
b10	
b11	
b12	
b13	
b14	
b15	

### V1.1.17 *Prevent MC Ready* # 1609

Additional reasons why ready state is prevented

Prevent MC Ready ID1609	
	Signal
b0	Endat option board (OPTBB, OPTBE) communication is not initialized after power-up.
b1	Drive sync master has wrong modulator or 1000ms task parameters are not initialized
b2	Drive sync follower delay is active
b3	Drive sync failure in sw modulator double period mode
b4	Charge switch delay is active
b5	AFE fast run disable through ENC C1 is active
b6	100ms task not executed
b7	Not synced to line: voltage, phase, angle, frequency or delayed
b8	Line phase detection fails or line phase missing
b9	
b10	
b11	
b12	
b13	
b14	
b15	

V1.1.18 *Status Word 2* # 89

The Application Status Word combines different statuses of the drive to one data word, useful for ID Control DO functions.

Status Word 2 (Application) ID89		
	FALSE	TRUE
b0	Value Control SR = FALSE	Value Control SR = TRUE
b1		
b2		
b3		
b4		
b5		
b6		
b7		
b8		
b9		
b10		
b11		
b12		
b13		
b14		
b15		

**5.2.2 MONITORING 2 VALUES****V1.2.1 DC Voltage V ID44**

The measured DC voltage, unfiltered.

**V1.2.2 Operation Mode ID1615**

The active Grid Converter operation mode. Operation mode is also included in Status Word.

0 = AFE operation

1 = Island operation

2 = Micro Grid Operation

**V1.2.3 Used Current Ref % ID 1704**

The used current reference. The value is negative to the set parameter to make the monitoring easier in NCDrive since Active Current shows negative value when power direction is from DC-Link to AC Line When the Current Reference mode is not used this will show Active Current.

**V1.2.4 D7 Synch. Error ID 1659**

An error on voltage angles between the drive and the measurement taken by OPT-D7.

-3072...+3071 = -180...180 degrees.

If the value is not near to zero when running in AFE mode, the phase order may be wrong even if the OPT-D7 frequency is correct (Error about 2047 = 120 degree).

Since system software V205:

If the measurement is after the Dyn11 transformer, the error is usually about 512 (30.0 Degrees) if P2.1.11 Transformer phase shift is zero, if set correctly error should be near zero.

**V1.2.5 CosPhiActual ID 1706**

The calculated Cos Phi.

**V1.2.6 Unit Temperature °C ID 1109**

The heatsink temperature of the drive.

**V1.2.7 Frequency Reference Hz ID1752**

The used frequency reference. In AFE mode, the frequency reference is determined internally when the synchronisation is made. In Island and Micro Grid mode, the reference is used for a static power supply, and a power drooping in Micro Grid mode.



**V1.2.8**    *Current*    *A*        *ID 1113*

The unfiltered current of the drive.

**V1.2.9**    *Operation Hours*        *h*        *ID1856*

This shows operation hours of the drive. G2.7 Operation Time is used to enter old value if the software is updated.

**V1.2.10**    *Reactive Current Reference*    *%*        *ID1389*

The final reactive current reference.

**V1.2.11**    *Grid State* *ID1882*

The Status Word for the grid.

Grid State ID1882	
b0	Supply frequency or frequency from OPT-D7 below fault limit
b1	Supply frequency or frequency from OPT-D7 below warning limit
b2	Supply frequency or frequency from OPT-D7 above warning limit
b3	Supply frequency or frequency from OPT-D7 above fault limit
b4	Voltage from OPT-D7 below fault limit
b5	Voltage from OPT-D7 below warning limit
b6	Voltage from OPT-D7 above warning limit
b7	Voltage from OPT-D7 above fault limit
b8	Supply voltage below fault limit
b9	Supply voltage below warning limit
b10	Supply voltage above warning limit
b11	Supply voltage above fault limit
b12	
b13	
b14	
b15	

**V1.2.12**    *Mindex*        *%*        *ID1874*

This value can be used to recognize low Dc-Link voltage when operating in island and uGrid modes. If the value is above 90%, the drive is in limits to make correct voltage to the AC side.

**V1.2.13**    *IU rms*    *A*        *ID39***V1.2.14**    *IV rms*    *A*        *ID40***V1.2.15**    *IW rms*    *A*        *ID41*

Phase currents. 1 second linear filtering.

**V1.2.16**    *DC-Link Current*        *[A]*        *ID72*

Calculated DC-Link Current in Amps.

V1.2.17 *DC-Link ActCurr* [%] #,# ID1158

Calculated DC-Link Current in %.

V1.2.18 *Iq Actual %* #,# ID4

Filtered by P2.17.16.11

V1.2.19 *Id Actual %* #,# ID1134

### 5.2.3 FIELDBUS MONITORING VALUES

#### V1.3.1 FB Control Word ID 1160

The control word from fieldbus. The table below is for “3 / Vacon AFE 2” Selection (P2.10.35) in bypass operation for such fieldbus board that natively supports this or can be parameterised to bypass mode. See other profile selections from chapter Status and Control Word.

FB Control Word ID1160			
	Signal	Comment	SM
B00	DC Charge	0= Open MCB. 1= Close DC charge contactor, MCB closed automatically, see B01.	1,2,3
B01	MCB Close Enable	0= Disable Closing of MCB (Also opens if Control Options.B0=TRUE) 1= Enable Closing of MCB (Works also for reclosing)	3
B02	Quick Stop	0= Quick Stop 1= No Quick Stop	3
B03	Run	0= AFE is stopped 1= AFE is started	1,2,3
B04	Output Power Limit to Zero	0= Output Power Limit to Zero 1= Output Power Limit = P2.5.2.1	3
B05	Disable Power Increase. Input or Output	0= Disable increase of power. 1= Power limits defined by G2.5.2	3
B06	Input Power Limit to Zero	0= Input Power Limit to Zero (7%) 1= Output Power Limit = P2.5.2.2	3
B07	Reset	0>1 Reset fault.	1,2,3
B08	DC Voltage Ref B00	B00   B01	2,3
B09	DC Voltage Ref B01	0   0 = FB Reference. P2.2.1, if not FB Control & FB Ref > 50,00 % 0   1 = 110 % 1   0 = 115 % 1   1 = 120 %	2,3
B10	Fieldbus Control	0= No control from fieldbus 1=Control from fieldbus	2,3
B11	Watchdog	0>1>0>1...0,5 sec square wave clock. This is used to check data communication between fieldbus master and the drive.	2,3
B12	FB DIN2	Can be used to control RO or directly parameter by ID number. G2.4.1	1,2,3
B13	FB DIN3	Can be used to control RO or directly parameter by ID number. G2.4.1	1,2,3
B14	FB DIN4	Can be used to control RO or directly parameter by ID number. G2.4.1	1,2,3
B15		Reserved for future use.	

### V1.3.2 *FB Status Word* ID 68

This is referred as GeneralStatusWord in the fieldbus manual. See details in the fieldbus manual.

FB Status Word ID68		
	Signal	Comment
b0	Ready On	0 = Drive not ready to charge 1 = Drive ready to charge
b1	Ready Run	0 = Drive not ready to run 1 = Drive ready to run and MCB is ON
b2	Running	0 = Drive not running 1 = Drive running with regenerative control ON
b3	Fault	0 = No active fault 1 = Fault is active
b4	Run Enabled	0 = Run Disabled by I/O Commands 1 = Run Enabled by I/O Commands
b5	Quick Stop	0 = Quick Stop Active 1 = Quick Stop Not Active
b6	Switch On Inhibit	0 = CB Control OK 1 = CB Requested open but DC is high
b7	Warning	0 = No warning 1 = Warning active
b8	At Reference	0 = DC Voltage Ref and Act DC Voltage are not same. 1 = DC Voltage Ref and Act DC Voltage are same.
B9	Fieldbus Control Active	0 = Fieldbus control not active 1 = Fieldbus control active
b10	Above Limit	0 = DC voltage is below the level specified by P2.5.7.4 1 = The DC voltage is above the level specified by P2.5.7.2 DC Superv. Limit
b11	MCB Control (DO Final)	0= Drive is controlling MCB to be Open. 1= Drive is controlling MCB to be Closed
b12	MCB Feedback	0= Feedback indicates MCB to be Open 1= Feedback indicates MCB to be Closed
b13		Reserved for future use.
B14	DC Charge DO Control	0= DC not charged 1= DC Charging Active
b15	Watchdog	Same as received on bit 11 of the FB Control Word.

V1.3.3 *Fault Word 1*

ID 1172

b0		F1 Over current, F31 IGBT, F41 IGBT
b1		F2 Over Voltage
b2		F9 Under Voltage
b3		F91 Short Circuit
b4		F3 Earth Fault
b5		
b6		F14 Unit Over temperature
b7		Temperature fault from measurements F56 PT100, F29 Thermistor
b8		F10 Line Synch Fault
b9		
b10		
b11		F52 Keypad or OC communication fault
b12		F53 Fieldbus fault
b13		F59 System bus fault
b14		F54 Slot Communication fault
b15		F50 4mA fault

V1.3.4 *Fault Word 2*

ID 1173

b0		F11 Output Phase Fault
b1		F80 Charge Fault
b2		
b3		
b4		
b5		
b6		F51 External fault
b7		
b8		
b9		F31 IGBT, F41 IGBT
b10		
b11		
b12		
b13		
b14		F64 MCB State fault
b15		

**V1.3.5 Warning Word 1 ID 1174**

	Warning	Comment
b0	W91 Short Circuit	Triggered when current has reached current limit
b1	W29 Thermistor	Not implemented
b2		
b3		
b4		
b5		
b6	F53_FB_Warning_Slot_D	
b7	F67_FB_Warning_Slot_E	
b8	W14 Unit Temperature	
b9		
b10		
b11		
b12		
b13		
b14		
b15		

**V1.3.6 FB Micro Grid CW1 ID 1700**

Control for the Micro Grid operations.

FB Micro Grid CW1 ID1700		
	Signal	Comment
b0	Start As Island	If B0 & B1 = FALSE operation mode is AFE. B10 to enable. B11 to change in Run State
b1	Start As Micro Grid	
b2	Start synchronisation D7	Synchronization to external grid with OPT-D7
b3		
b4	Power Down	Same as P2.2.6.2
b5	Power Up	Same as P2.2.6.3
b6	Reset Hz MotPot	Same as P2.4.2.27
b7	Voltage Down	Same as P2.2.6.7
b8	Voltage Up	Same as P2.2.6.8
b9	Reset Volt MotPot	
b10	Enable FB Control Mode	B0 and B1 are controlling Operation Mode
b11	Live Mode Control	B0 and B1, Mode changed in Run State
b12	P2.10.27 uCW B12	
b13	P2.10.28 uCW B12	
b14	P2.10.29 uCW B12	
b15	P2.10.30 uCW B12	

**V1.3.7**     *FB Micro Grid SW1*                      *ID 1701*

Status of the Micro Grid operations.

Micro Grid Status Word		
	Signal	Comment
b0	Charge Control active	Charging
b1	Internal Charging switch status	
b2	MCB control	
b3	MCB status	
b4	Run Enabled	
b5	Drive Ready	
b6	AFE mode active	
b7	Island mode active	
b8	Micro Grid mode active	
b9	Run Request active	
b10	Drive in run state	
b11	Fault Active	
b12	SynchronizedToD7	
b13		
b14	D7 measurements OK	
b15		

**V1.3.8**     *Warning ID74*

The number of the last active warning.

**V1.3.9**     *Last Active Fault*                      *ID37*

The number of the last active fault.

*V1.3.10 MC Status**ID 64*

For the fieldbuses that do not have their own state machine, this value is sent to fieldbus.

Motor Control Status Word		
	FALSE	TRUE
b0	Not in Ready state	Ready
b1	Not Running	Running
b2	Direction Clockwise	Counter clockwise
b3	No Fault	Fault
b4	No Warning	Warning
b5		At reference speed
b6		At Zero Speed
b7		Flux Ready
b8		TC Speed Limiter Active
b9	Encoder Direction	Counter clockwise
b10		Under Voltage Fast stop
b11	No DC brake	DC Brake is active
b12		
b13		Restart delay active
b14		
b15		

*V1.3.11 FB Analogue Output**ID 48*

Signal to control analogue output from fieldbus.



**5.2.4 I/O MONITORING VALUES**

V1.4.1 *DIN1, DIN2, DIN3* *ID 15*

V1.4.2 *DIN4, DIN5, DIN6* *ID 16*

	DIN1/DIN2/DIN3 status	DIN4/DIN5/DIN6 status
b0	DIN3	DIN6
b1	DIN2	DIN5
b2	DIN1	DIN4

V1.4.3 *DIN Status 1* *ID 56*

V1.4.4 *DIN Status 2* *ID 57*

	DIN StatusWord 1	DIN StatusWord 2
b0	DIN: A.1	DIN: C.5
b1	DIN: A.2	DIN: C.6
b2	DIN: A.3	DIN: D.1
b3	DIN: A.4	DIN: D.2
b4	DIN: A.5	DIN: D.3
b5	DIN: A.6	DIN: D.4
b6	DIN: B.1	DIN: D.5
b7	DIN: B.2	DIN: D.6
b8	DIN: B.3	DIN: E.1
b9	DIN: B.4	DIN: E.2
b10	DIN: B.5	DIN: E.3
b11	DIN: B.6	DIN: E.4
b12	DIN: C.1	DIN: E.5
b13	DIN: C.2	DIN: E.6
b14	DIN: C.3	
b15	DIN: C.4	

V1.4.5 *Analogue Input 1* % *ID13*

V1.4.6 *Analogue Input 2* % *ID14*

V1.4.7 *Analogue Input 3* % *ID 27*

V1.4.8 *Analogue Input 4* % *ID28*

The unfiltered analogue input level.

0% = 0 mA / 0 V, -100% = -10 V, 100% = 20 mA / 10 V. Monitoring scaling is determined by the option board parameter. It is possible to adjust this input value from fieldbus when the input terminal selection is 0.1. This way it is possible to adjust the free analogue input from fieldbus and have all the analogue input functions available for fieldbus process data.

V1.4.9 *Analogue Out 1* % ID 26

V1.4.10 *Analogue Out 2* % ID 31

V1.4.11 *Analogue Out 3* % ID 32

Analogue Output value 0% = 0 mA / 0 V, 100% = 20 mA / 10 V

V1.4.12 *PT100 MaxTemp* °C ID 42

V1.4.13 *PT100 Temp. 1* °C ID 50

V1.4.14 *PT100 Temp. 2* °C ID 51

V1.4.15 *PT100 Temp. 3* °C ID 52

V1.4.16 *PT100 Temp. 4* °C ID 69

V1.4.17 *PT100 Temp. 5* °C ID 70

V1.4.18 *PT100 Temp. 6* °C ID 71

A separate measurement from two PT100 board. The signal has a 4 s filtering time.

### 5.2.5 MASTER FOLLOWER

V1.5.1 *SB SystemStatus* # ID1819

System Bus Status Word ID1819	
b0	
b1	Drive 1 Ready
b2	Drive 1 Running
b3	Drive 1 Fault
b4	
b5	Drive 2 Ready
b6	Drive 2 Running
b7	Drive 2 Fault
b8	
b9	Drive 3 Ready
b10	Drive 3 Running
b11	Drive 3 Fault
b12	
b13	Drive 4 Ready
b14	Drive 4 Running
b15	Drive 4 Fault

## V1.5.2 Master CW # ID93

Master Control Word ID93	
b0	
b1	Master Run State
b2	Run Request (Pre)
b3	Fault Reset
b4	Start (Pre)
b5	WD Pulse
b6	MCB Open Commands
b7	MCB Close Request (Start)
b8	DIN Run Enable
b9	Datalogger trigger
b10	
b11	
b12	
b13	
b14	
b15	

5.2.5.1 Currents

V1.5.3.1	Current D1	A	Varies 1820
V1.5.3.2	Current D2	A	Varies 1821
V1.5.3.3	Current D3	A	Varies 1822
V1.5.3.4	Current D4	A	Varies 1823

5.2.5.2 Statuses

V1.5.4.1	Status Word D1	#	1828
V1.5.4.2	Status Word D2	#	1829
V1.5.4.3	Status Word D3	#	1830
V1.5.4.4	Status Word D4	#	1831

Follower Drive status word	
b0	Datalogger trigger
b1	Ready
b2	Run
b3	Fault
b4	
b5	
b6	
b7	
b8	MCB Control (Follower)
b9	MCB Closed
b10	MCB Open Commands
b11	
b12	
b13	
b14	
b15	WD Pulse

**5.2.6 LICENCE ACTIVATION STATUS****V1.6.1 Serial Number Key ID1997**

Give this number to the technical support of the manufacturer when there is a problem in the activation of a function.

**V1.6.2 Licence Status Grid Converter ID1996****V1.6.3 License Status Grid Code ID1993**

This value indicates the status of the licence key activation.

**0 / No Function**

If PLC receives this number from this ID, it is likely that the Grid Converter application is not loaded on the drive.

**1 / No Code**

Correct application in the drive, but the licence key has not been given.

**2 / Code Given, not possible to verify, no connection to power unit**

The licence key has been given, but there is no connection to power unit to verify it.

Charge the DC at least for 20 s.

**3 / Code Wrong**

The code that was entered is wrong.

**4 / Licence Key entered too many times**

A wrong licence key has been entered three times. Power down the drive before trying to enter a new code.

**5 / Code Accepted**

The correct key has been entered, and all functions of Grid Converter application are available.

## 5.2.7 GRID CODE

## V1.7.1 Grid Code State

ID2203

ID3548

Grid Code State ID2203		
	Signal	
b0	Grid Code Running	AFE Mode, License OK and Grid Code enabled
b1	Grid Code Run Enable	No Grid Code trip and Re-Connection time has passed
b2	FRT Active	
b3	Line Voltage High 1	
b4	Line Voltage High 2	
b5	Line Voltage High 3	
b6	Line Voltage Low 1	
b7	Line Voltage Low 2	
b8	Line Voltage Low 3	
b9	Line Voltage Low 4	
b10	Line Freq High 1	
b11	Line Freq High 2	
b12	Line Freq High 3	
b13	Line Freq Low 1	
b14	Line Freq Low 2	
b15	Line Freq Low 3	
b16	Line Frequency OK	
b17	Line Voltage OK	
b18	Trip Request	Grid Code command to open MCB
b19	FRT NegSequence	
b20	LVRT Timer Start	
b21	LVRT Bi Timer Start	
b22	Dynamic Grid Support Active	
b23	Re-Connection	Drive is in re-connection sequence
b24		
b25		
b26		
b27		
b28		
b29	Line Freq Low Power Ref	
b30	Line Freq High Power Ref	
b31	Line Voltage High Power Ref	

**V1.7.2 Line State ID2202 ID3547**

16 bit version of ID2203 Grid Code State

Line State ID2202		
Signal		
b0	Line voltage above high trip limits	
b1	Line Voltage below low trip limits	
b2	Line Frequency above high trip limits	
b3	Line Frequency below low trip limits	
b4		
b5		
b6		
b7		
b8		
b9		
b10		
b11	Line Frequency OK	Within OK limits
b12	Line Voltage OK	Within OK limits
b13	FRT Active	Fault Ride Trough Active
b14		
b15	Grid Code Trip Active	

**V1.7.3 Line Voltage GC % #,## 1912**

Scaled line voltage from OPT-D7.

This signal is used in Grid Code functions that are running in 5 ms time level.

Filtered by P2.17.16.2 Voltage Filt TC ID3332

**V1.7.4 Line Frequency GC % #,## 1913**

Scaled line frequency from OPT-D7

This signal is used in Grid Code functions that are running in 5 ms time level.

Filtered by P2.17.16.3 Voltage Filt TC ID3333

**V1.7.5 Line Voltage GC2% #,## 4500**

Scaled line voltage, high filtered.

This signal is used in Grid Code functions that have high slope in relation to voltage.

Filtered by P2.17.16.8 LVHighFiltTC ID3373

**V1.7.6 Line Freq. GC0 % #,## 4501**

Scaled Line Frequency, low filtering.

This signal is used line frequency tripping limits when tripping delay time is less than 500 ms

Filtered by P2.17.16.9 LineFreqLow TC ID3375

V1.7.7	Line Voltage L1-L2	%	###	ID3203
V1.7.8	Line Voltage L2-L3	%	###	ID3204
V1.7.9	Line Voltage L3-L1	%	###	ID3205

D7 main rms voltages scaled to percent. 100,00 % = Grid Nom Voltage.

V1.7.10	Trip State		ID2206	ID3549
---------	------------	--	--------	--------

This is same as the F95 Grid code sub code

- 0: No Trip
- 2: Line Voltage High Level 1
- 3: Line Voltage High Level 2
- 4: Line Voltage Low Level 1
- 5: Line Voltage Low Level 2
- 6: Line Frequency High Level 1
- 7: Line Frequency High Level 2
- 8: Line Frequency Low Level 1
- 9: Line Frequency Low Level 2
- 10: LVRT Three Phase trip.
- 11: LVRT Bi-Phase trip
- 12: Separate limits or forced trip
- 13: Line Frequency change rate trip.
- 14: 10 Min Average high voltage trip
- 16: Line Voltage High 3 Trip
- 17: Line Voltage Low 3 Trip
- 18: Line Frequency High 3 Trip
- 19: Line Frequency Low 3 Trip
- 20: Anti-Islanding Trip
- 21: Bi-Phase High Voltage 1 Trip
- 22: Bi-Phase High Voltage 2 Trip
- 23: Bi-Phase High Voltage 3 Trip
- 24: Bi-Phase Low Voltage 1 Trip
- 25: Bi-Phase Low Voltage 2 Trip
- 26: Bi-Phase Low Voltage 3 Trip
- 27: Line Voltage Low 4 Trip
- 28: Bi-Phase Low Voltage 4 Trip

V1.7.11	PosSeqVoltage	V	##	3511
---------	---------------	---	----	------

V1.7.12	NegSeqVoltage	V	##	3512
---------	---------------	---	----	------

V1.7.13	NewSeqCurrent	%	##	3513
---------	---------------	---	----	------



**5.2.8 PI POWER CONTROLLER**

Monitoring values for power controller in AFE mode

*V1.8.1 PID Reference 20*

Active Current reference

*V1.8.2 PID Actual Value 21*

Active current

*V1.8.3 PID Output 23*

PID controller output for DC Voltage reference, gives an offset for DC Voltage Reference.

**5.2.9 ACTIVE LIMITS**

*V1.9.1 Output Power Limit ID1953*

*V1.9.2 Input Power Limit % #,# 1952*

*V1.9.3 Current Limit ID1954*

**5.2.10 LINE MONITORING**

*V1.10.1 Line Voltage D7 V ID 1650*

The measured line voltage rms value when using the OPT-D7 option board in slot C.

*V1.10.2 Line Frequency D7 Hz ID 1654*

The measured line voltage frequency when using the OPT-D7 option board in slot C.

*V1.10.3 Line Voltage THD % ID 1670*

Total Harmonic Distortion of the line voltage measurement when using the OPT-D7 option board in slot C.

*V1.10.4 Line Voltage HF RMS V ID 1671*

Root Mean Square value of high frequency components in the line voltage measurement when using the OPT-D7 option board in slot C.

*V1.10.5 Line Voltage D7.1 V #,# 4503*

The measured line voltage rms value with one decimal, less filtered than ID1650.

V1.10.6 *Active Power D7 %*                    #,#    4504

Active current compensates with line voltage at D7 measurement.

V1.10.7 *Reactive Power D7*            %       #,#    4505

Reactive current compensated with line voltage at D7 measurement.

## 6. PARAMETER LIST

In this chapter you will find the lists of parameters that are available in this application.

### 6.1 BASIC PARAMETERS

Table 2. Basic parameters, G2.1

Code	Parameter	Min	Max	Unit	Default	Step	ID	Description
P2.1.1	Grid Nom Voltage	Varies	Varies	Vac	500V:400 690V:690	1	110	Set the nominal voltage of the grid.  Set also System Nominal DC P2.1.7
P2.1.2	Grid Nom. Frequency	0	320	Hz	50.00	0,01	1532	<b>Micro Grid and Island mode:</b> Grid Nominal Frequency <b>AFE Mode:</b> Initial start frequency.
P2.1.3	Grid Converter Rated Current	0.0	Varies	A	Varies	Varies	113	Recommended to keep default. Used to scale % values. See Default Currants in Chapter 1
P2.1.4	System Cos Phi	0.10	1.00		0.85	0,01	120	
P2.1.5	System Rated kVA	0	32000	kVA	0	Varies	213	
P2.1.6	System Rated kW	0	32000	kW	0	Varies	116	
P2.1.7	System Nominal DC	0	1300	Vdc	500V:675 690V:931	1	1805	Used for DC Voltage reference and for MCB close limit
P2.1.8	Parallel AFE	0	1		0	2	1501	<b>0</b> = Single AFE <b>1</b> = Parallel AFE Activation will set DC Drooping to 3%.
P2.1.9	Transformer: Grid Converter Side U	0	3200	Vac	1000	0,1	1850	
P2.1.10	Transformer: Grid Side	0	3200	Vac	1000	0,1	1851	
P2.1.11	Transformer: Phase Shift	-360	360	Deg	0.0	0,1	1852	e.g. Dyn11 = 30.0 Degree
P2.1.12	Identification	0	1		0	1	631	<b>0</b> = No Action <b>1</b> = Current Offset

### 6.2 REFERENCE HANDLING

Table 3. Reference handling

Code	Parameter	Min	Max	Unit	Default	Step	ID	Description
P2.2.1	DC Voltage Ref.	500V: 105%  690V: 105%	500V: 797 Vdc 690V: 1099 Vdc	%	110.00	0,01	1462	DC Voltage reference as % of Nominal DC voltage = 1.35 * Grid Nominal Voltage.
P2.2.2	Reactive Current Reference	-170	170	%	0	0,1	1459	Regenerative reactive current reference 100.0 = Nominal current. Positive = Inductive Negative = Capacitive

## 6.2.1 DC REFERENCE TUNING

Table 4.

Code	Parameter	Min	Max	Unit	Default	Step	ID	Description
P2.2.3.1	DC Voltage Drooping	0	100	%	0,00	0,01	620	AFE drooping DC-voltage.
P2.2.3.2	DC Voltage Reference Ramp Rate	-10	10000	%/s	-1	1	1199	< 0 = Bypass ramp
P2.2.3.3	DCV PI Power Follower rate	-1	32,000	%/s	0.00	0,001	1678	
P2.2.3.4	DC Reference Offset	-15	15	%	0,00	0,01	1776	
P2.2.3.5	DC Reference Mode	-1	2		1	1	1718	-1 = Direct Iq Ref 0 = Fixed 1 = Floating 2 = PI Ref Float

## 6.2.2 POWER / FREQUENCY REFERENCE

Table 5.

Code	Parameter	Min	Max	Unit	Default	Step	ID	Description
P2.2.4.1	Freq Droop Offset	-5.00	5.00	Hz	0.00	0,01	1791	
P2.2.4.2	Freq. Down	0.1	E.10	DigIn	0.1	0,1	417	
P2.2.4.3	Freq. Up	0.1	E.10	DigIn	0.1	0,1	418	
P2.2.4.4	Freq. Adjust Rate	0.001	20.000	Hz/s	0.100	0,001	331	
P2.2.4.5	Freq. Max Adjust	0.00	25.00	Hz	2.50	0,01	1558	
P2.2.4.6	Base Current Ref.	-170.0	170.0	%	0.0	0,1	1533	
P2.2.4.7	Base reference increase rate	0	10000	%/s	100	1	1536	
P2.2.4.8	Base Ref To Zero	0	3		0	1	1537	0 = No Action 1 = At Stop State 2 = When AFE 3 = Stop & AFE
P2.2.4.9	Base Reference At Stop	0	170.0	%	5.0	0,1	1538	
P2.2.4.10	FreqMotPotReset	0	3		0	1	367	0 = No Action 1 = At Stop State 2 = When AFE 3 = Stop & AFE
P2.2.4.11	Reference Mode	0	1		0	1	1914	0=Pure Iq Ref 1= Voltage Comp. Iq Ref

**6.2.2.1** PID Power Controller for AFE

Table 6.

Code	Parameter	Min	Max	Unit	Default	Step	ID	Description
P2.2.4.12.1	PID Power Activation	0,1	E.10	DigIN	0,1	0,1	1905	
P2.2.4.12.2	PID Kp	0,00	1e6	%	120,00	0,01	1911	
P2.2.4.12.3	PID Ti	0	1e5	ms	210	1	1906	
P2.2.4.12.4	PID DC Low	-50,00	50,00	%	-5,00	0,01	1903	
P2.2.4.12.5	PID DC High	-50,00	50,00	%	5,00	0,01	1904	
P2.2.4.12.6	Reference Down Rate	-1,00	320	%/s	50,00	Varies	1810	Format by P2.2.4.12.14
P2.2.4.12.7	Reference Up Rate	-1,00	320	%/s	50,00	Varies	1811	Format by P2.2.4.12.14
P2.2.4.12.8	PIActLimGapToReq	0,0	20,0	%	5,0	0,1	1842	
P2.2.4.12.9	PIRefLimGapToReq	0,0	20,0	%	0,0	0,1	1844	
P2.2.4.12.10	ZeroErrorLimit	0,0	20,0	%	0,0	0,1	1843	
P2.2.4.12.11	PI Start Delay	0	32000	ms	200	1	1845	
P2.2.4.12.12	PID FRT Kp	0	1000	%	300	0,01	1915	
P2.2.4.12.13	PID FRT Ti	0	10000 0	ms	125	1	1916	
P2.2.4.12.14	RefRampFormat	1	6		3 / #,##	1	4530	

**6.2.2.2** High Frequency Power Reference

Code	Parameter	Min	Max	Unit	Default	Cust	Step	ID	Description
P2.2.4.13.1	PowDecLogInFreq	0,00	200,00	%	0,00		0,01	4510	
P2.2.4.13.2	PowDecLogOffFreq	0,00	200,00	%	0,00		0,01	4511	
P2.2.4.13.3	PowerDecSlope	0,0	3200,0	%/%	0,0		0,1	4512	
P2.2.4.13.4	PowerDecOffRamp	-1,00	320,00	%/s	-1,00		0,01	4513	
P2.2.4.13.5	PowerDecOffDelay	0,0	600	s	0,000		0,001	4514	
P2.2.4.13.6	PowerDec Max	0,0	300,0	%	300,0		0,1	4515	
P2.2.4.13.7	PowerDecHighFreq	0,00	200,00	%	0,00		0,01	4516	

**6.2.2.3** Low Frequency Power Reference

Code	Parameter	Min	Max	Unit	Default	Cust	Step	ID	Description
P2.2.4.14.1	Power Increase Log In Frequency	0,00	200,00	%	0,00		0,01	4517	
P2.2.4.14.2	Power Increase Log Off Frequency	0,00	200,00	%	0,00		0,01	4518	
P2.2.4.14.3	Power Increase Slope	0,0	200,0	%/%	0,0		0,1	4519	
P2.2.4.14.4	Power Increase Off Ramp	-1,00	320,00	%	-1,00		0,01	4520	
P2.2.4.14.5	Power Increase Off Delay	0	600	s	0,000		0,001	4521	
P2.2.4.14.6	Power Increase Max	0	300,0	%	300,0		0,1	4522	
P2.2.4.14.7	Power Increase Low Frequency	0	200,00	%	0,00		0,01	4523	
P2.2.4.14.8	Power Increase Set Power Frequency	0	200,00	%	0,00		0,01	4524	

### 6.2.3 REACTIVE REFERENCE

Table 7.

Code	Parameter	Min	Max	Unit	Default	Step	ID	Description
P2.2.5.1	Reactive Adjust Rate	0.0	1000.0	%/s	1.0	0,1	1557	
P2.2.5.2	Reactive Ref Up	0.1	E.10	DigIn	0.1	0,1	1553	
P2.2.5.3	Reactive Ref Down	0.1	E.10	DigIn	0.1	0,1	1554	
P2.2.5.4	MaxReactiveAdjust	0,0	100,0	%	25,0	0,1	1559	
P2.2.5.5	Reactive Mot Pot Reset	0	1		1	1	1644	
P2.2.5.6	Reactive Reference Filtering TC	0,00	100,00	s	0,00	0,01	3554	

### 6.2.4 AC VOLTAGE REFERENCE

Table 8.

Code	Parameter	Min	Max	Unit	Default	Step	ID	Description
P2.2.6.1	Voltage at field weakening point	10.00	200.00	%	100.00	0,01	603	
P2.2.6.2	Field weakening point	8.00	320.00	Hz	45.00	0,01	602	
P2.2.6.3	Voltage Correction	-50	50	V	0	1	1790	
P2.2.6.4	Capacitor Size	0.0	100.0		6,7	0,1	1460	
P2.2.6.5	Inductor Size	0.0	100.0		1,2	0,1	1461	
P2.2.6.6	Inductor Losses	0.0	100.0		12,0	0,1	1465	
P2.2.6.7	Voltage Down	0.1	E.10	DigIn	0.1	0,1	1551	
P2.2.6.8	Voltage Up	0.1	E.10	DigIn	0.1	0,1	1550	
P2.2.6.9	Voltage Adjust Rate	0.0	1000.0	%/s	1.0	0,001	1555	
P2.2.6.10	Voltage Maximum Adjust	0	20	%	20	0,01	1639	
P2.2.6.11	VoltMotPotReset	0	1		0	1	1640	0 = No Action 1 = At Stop
P2.2.6.12	Start Voltage Mode	0	2		1	1	1641	0 = Zero Q Start 1 = Drooping 2 = Reactive Ref
P2.2.6.13	Reset Zero Q Delay	0,00	120,00		0,00	0,01	1642	0,00 = No Reset
P2.2.6.14	Zero Q Max Adjust	0,00	50,00	%	7,50	0,01	1643	
P2.2.6.15	Capacitor Size 2 <sup>nd</sup>	0,0	100,0	%	0,0	0,1	3330	
P2.2.6.16	Capacitor Size 2 <sup>nd</sup> Voltage	0,0	1100,0	%	0,0	0,1	3331	
P2.2.6.17	KeepCurrLMaxAdju	0,00	50,00	%	0,00	0,01	1645	
P2.2.6.18	CapSizeIncrease					0,1		

### 6.3 RAMP CONTROL

Table 9.

Code	Parameter	Min	Max	Unit	Default	Step	ID	Description
P2.3.1	Ramp Time	0.1	3200.0	s	25.0	0,1	103	2.00 Hz/s if Range 50 Hz
P2.3.2	Ramp Range	0.01	100.00	Hz	50.00	0,01	1980	
P2.3.3	Transf. Magnet	0	2		0	1	1966	0 = No 1 = Yes 2 = Commissioning

## 6.4 INPUT SIGNALS

### 6.4.1 BASIC SETTINGS

Table 10.

Code	Parameter	Min	Max	Unit	Default	Step	ID	Description
P2.4.1.1	Start/Stop Logic	0	3		0	1	300	0 = Start-No Act 1 = Rpuls-Fpuls 2 = Rpuls-Rpuls 3 = IO Toggle (Testing)
P2.4.1.2	Input Inversion	0	65535		4	1	1091	Inversion control of the input I/O signals. B0 = INV Open Contactor B1 = INV Ext. Fault 1 B2 = INV Ext. Fault 2 B3 = INV Enable MCB Close B4 = INV DC Ground Fault
P2.4.1.3	IOStopDelToggle	0	320	s	15	0,01	4001	Testing Purposes
P2.4.1.4	IOStartDelToggle	0	320	s	15	0,01	4000	Testing Purposes

## 6.4.2 DIGITAL INPUTS

Table 11. Digital inputs , G2.2.1

Code	Parameter	Min	Max	Unit	Default	Step	ID	Description
P2.4.2.1	Start Signal 1	0	E.10	DigIn	A.1	0,1	403	
P2.4.2.2	Start Signal 2	0	E.10	DigIn	0.1	0,1	404	
P2.4.2.3	Open MCB	0	E.10	DigIn	0.1	0,1	1600	Forced open command
P2.4.2.4	CB Feed Back	0	E.10	DigIn	A.4	0,1	1453	AFE MCB feedback (MCB 1)
P2.4.2.5	Fault Reset	0	E.10	DigIn	0.1	0,1	414	
P2.4.2.6	Ext Fault 1	0	E.10	DigIn	0.1	0,1	405	
P2.4.2.7	Ext Fault 2	0	E.10	DigIn	0.2	0,1	406	
P2.4.2.8	Run Enable	0	E.10	DigIn	0.2	0,1	407	
P2.4.2.9	NET Synchronisation	0	E.10	DigIn	0.1	0,1	1602	
P2.4.2.10	NET Close Enabled	0	E.10	DigIn	0.1	0,1	1705	Interlock for shore connection
P2.4.2.11	NET Close Request	0	E.10	DigIn	0.1	0,1	1604	
P2.4.2.12	NET Contactor FB	0	E.10	DigIn	0.1	0,1	1660	
P2.4.2.13	Forced AFE Mode	0	E.10	DigIn	0.1	0,1	1540	Force mode to AFE
P2.4.2.14	Cooling Monitor	0	E.10	DigIn	0.2	0,1	750	OK input from the cooling unit
P2.4.2.15	Use CB 2	0	E.10	DigIn	0.1	0,1	1708	Second AFE contactor coming from second grid to have 2 different supplies
P2.4.2.16	CB 2 Status	0	E.10	DigIn	0.1	0,1	1710	Feedback signal from second AFE contactor
P2.4.2.17	AFE Mode 2	0	E.10	DigIn	0.1	0,1	1711	Only active when P2.11.1 is in 6/Free select
P2.4.2.18	AFE Mode 3	0	E.10	DigIn	0.1	0,1	1712	Only active when P2.1.1 is in 6/Free select
P2.4.2.19	Quick Stop	0	E.10	DigIn	0.2	0,1	1213	Stop and opens MCB
P2.4.2.20	LCL Temperature	0	E.10	DigIn	0.2	0,1	1179	
P2.4.2.21	RR Enable	0	E.10	DigIn	0.2	0,1	1896	
P2.4.2.22	I/O Terminal Control	0	E.10	DigIn	0.1	0,1	409	Disables final Run Command
P2.4.2.23	Keypad Control	0	E.10	DigIn	0.1	0,1	410	
P2.4.2.24	Fieldbus Control	0	E.10	DigIn	0.1	0,1	411	
P2.4.2.25	Enable MCB Close	0	E.10	DigIn	0.2	0,1	1619	
P2.4.2.26	Reset P/Hz Mpot	0	E.10	DigIn	0.1	0,1	1608	
P2.4.2.27	DC Ground Fault	0	E.10	DigIn	0.1	0,1	441	
P2.4.2.28	Klixon In 1	0.1	E.10	DigIn	0.2	0,1	780	
P2.4.2.29	Klixon In 2	0.1	E.10	DigIn	0.2	0,1	781	
P2.4.2.30	Input Switch	0.1	E.10	DigIn	0.2	0,1	1209	
P2.4.2.31	Ambient Temp	0.1	E.10	DigIn	0.2	0,1	783	



**6.4.3 ANALOGUE INPUT 1***Table 12. Analogue Input 1, G2.2.2*

Code	Parameter	Min	Max	Unit	Default	Step	ID	Description
P2.4.3.1	AI1 signal selection	0.1	E.10		0.1	0,1	377	
P2.4.3.2	AI1 filter time	0.000	32.000	s	0.000	0,001	324	
P2.4.3.3	AI1 custom minimum setting	-160.00	160.00	%	0.00	0,01	321	
P2.4.3.4	AI1 custom maximum setting	-160.00	160.00	%	100.00	0,01	322	
P2.4.3.5	AI1 signal inversion	0	1		0	1	387	0 = No Inversion 1 = Inverted
P2.4.3.6	AI1 reference scaling, minimum value	-32000	32000		0	1	303	
P2.4.3.7	AI1 reference scaling, maximum value	-32000	32000		0	1	304	
P2.4.3.8	AI1 Controlled ID	0	10000		0	1	1507	

**6.4.4 ANALOGUE INPUT 2***Table 13. Analogue Input 2, G2.2.3*

Code	Parameter	Min	Max	Unit	Default	ID	Description
P2.4.4.1	AI2 signal selection	0.1	E.10		0.1	388	
P2.4.4.2	AI2 filter time	0.000	32.000	s	0.000	329	
P2.4.4.3	AI2 custom minimum setting	-160.00	160.00	%	20.00	326	
P2.4.4.4	AI2 custom maximum setting	-160.00	160.00	%	100.00	327	
P2.4.4.5	AI2 signal inversion	0	1		0	398	0 = No Inversion 1 = Inverted
P2.4.4.6	AI2 reference scaling, minimum value	-32000	32000		0	393	
P2.4.3.7	AI2 reference scaling, maximum value	-32000	32000		0	394	
P2.4.4.8	AI2 Controlled ID	0	10000		0	1511	

**6.4.5 ANALOGUE INPUT 3***Table 14. Analogue Input 2, G2.2.3*

Code	Parameter	Min	Max	Unit	Default	Step	ID	Description
P2.4.5.1	AI3 signal selection	0.1	E.10		0.1	0,1	141	
P2.4.5.2	AI3 filter time	0.000	32.000	s	0.000	0,001	142	
P2.4.5.3	AI3 custom minimum setting	-160.00	160.00	%	0.00	0,01	144	
P2.4.5.4	AI3 custom maximum setting	-160.00	160.00	%	100.00	0,01	145	
P2.4.5.5	AI3 signal inversion	0	1		0	1	151	0 = No Inversion 1 = Inverted
P2.4.5.6	AI3 reference scaling, minimum value	-32000	32000		0	1	1037	
P2.4.5.7	AI3 reference scaling, maximum value	-32000	32000		10000	1	1038	
P2.4.5.8	AI3 Controlled ID	0	10000		0	1	1509	

**6.4.6 ANALOGUE INPUT 4***Table 15. Analogue Input 2, G2.2.3*

Code	Parameter	Min	Max	Unit	Default	Step	ID	Description
P2.4.6.1	AI4 signal selection	0.1	E.10		0.1	0,1	152	
P2.4.6.2	AI4 filter time	0.000	32.000	s	0.000	0,001	153	
P2.4.6.3	AI4 custom minimum setting	-160.00	160.00	%	0.00	0,01	155	
P2.4.6.4	AI4 custom maximum setting	-160.00	160.00	%	100.00	0,01	156	
P2.4.6.5	AI4 signal inversion	0	1		0	1	162	0 = No Inversion 1 = Inverted
P2.4.6.6	AI4 reference scaling, minimum value	-32000	32000		0	1	1039	
P2.4.6.7	AI4 reference scaling, maximum value	-32000	32000		10000	1	1040	
P2.4.6.8	AI4 Controlled ID	0	10000		0	1	1510	

## 6.5 OUTPUT SIGNALS

### 6.5.1 DIGITAL OUTPUT SIGNALS

Table 16. Digital output signals, G2.3.1

Code	Parameter	Min	Max	Unit	Default	Step	ID	Description
P2.5.1.1	MCB1 Close Control	0.1	E.10		0.1	0,1	1218	AFE contactor.
P2.5.1.2	MCB1 Open Control	0.1	E.10		0.1	0,1	1219	
P2.5.1.3	Ready	0.1	E.10		0.1	0,1	432	The AC drive is ready to operate.
P2.5.1.4	Run	0.1	E.10		0.1	0,1	433	The AC drive operates (the motor is running).
P2.5.1.5	Common Fault	0.1	E.10		0.1	0,1	434	A fault trip has occurred.
P2.5.1.6	Fault, Inverted	0.1	E.10		0.1	0,1	435	No fault trip has occurred.
P2.5.1.7	At reference	0.1	E.10		0.1	0,1	442	
P2.5.1.8	Overtemperature Warn.	0.1	E.10		0.1	0,1	439	The heatsink temperature exceeds +70 °C
P2.5.1.9	Warning	0.1	E.10		0.1	0,1	436	General warning signal.
P2.5.1.10	CB2 Close Control	0.1	E.10		0.1	0,1	1709	Second AFE contactor control
P2.5.1.11	NET Contactor	0.1	E.10		0.1	0,1	1605	NET contactor ( DC )
P2.5.1.12	D7 Synchronized	0.1	E.10		0.1	0,1	1753	Drive is synchronised to D7 card
P2.5.1.13	Charge Control	0.1	E.10		0.1	0,1	1568	Charge control from start command
P2.5.1.14	Common Alarm	0.1	E.10		0.1	0,1	1684	
P2.5.1.15	Ready For Start	0.1	E.10		0.1	0,1	1686	No conditions that could disable starting active
P2.5.1.16	Quick Stop Active	0.1	E.10		0.1	0,1	1687	
P2.5.1.17	Fieldbus digital input 1	0.1	E.10		0.1	0,1	455	FB CW B11
P2.5.1.18	FB Dig 1 Parameter	0	4000	ID	0	1	891	Select parameter to control
P2.5.1.19	Fieldbus digital input 2	0.1	E.10		0.1	0,1	456	FB CW B12
P2.5.1.20	FB Dig 2 Parameter	0	4000	ID	0	1	892	Select parameter to control
P2.5.1.21	Fieldbus digital input 3	0.1	E.10		0.1	0,1	457	FB CW B13
P2.5.1.22	FB Dig 3 Parameter	0	4000	ID	0	1	893	Select parameter to control
P2.5.1.23	Fieldbus digital input 4	0.1	E.10		0.1	0,1	169	FB CW B14
P2.5.1.24	FB Dig 4 Parameter	0	4000	ID	0	1	894	Select parameter to control

**6.5.2 DELAYED DO 1***Table 17. Delayed DO 1, G2.3.2*

Code	Parameter	Min	Max	Unit	Default		ID	Description
P2.5.2.1	Dig.Out 1 Signal	0.1	E.10		0.1	0,1	486	Connect the delayed DO1 signal to the digital output of your choice with this parameter.
P2.5.2.2	DO1 Content	0	15		0	1	312	0 = Not used 1 = Ready 2 = Run 3 = Fault 4 = Fault inverted 5 = FC overheat warning 6 = Ext. fault or warning 7 = Ref. fault or warning 8 = Warning 9 = Reverse 10 = SynchronisedToD7 11 = Start Command given 12 = FB DIN2 13 = FB DIN3 14 = ID.Bit DO 15 = Warning SR
P2.5.2.3	DO1 ON Delay	0.00	320.00	s	0.00	0,01	487	0.00 = On delay not in use
P2.5.2.4	DO1 OFF Delay	0.00	320.00	s	0.00	0,01	488	0.00 = On delay not in use
P2.5.2.5	ID.Bit Free DO	0.00	4000.00	ID.Bit	0.00	0,01	1216	

**6.5.3 DELAYED DO 2***Table 18. Delayed DO 2, G2.3.3*

Code	Parameter	Min	Max	Unit	Default	Step	ID	Description
P2.5.3.1	Dig.Out 2 Signal	0.1	E.10		0.1	0,1	486	Connect the delayed DO2 signal to the digital output of your choice with this parameter.
P2.5.3.2	DO2 Content	0	15		0	1	490	See ID312 P2.5.2.2
P2.5.3.3	DO2 ON Delay	0.00	320.00	S	0.00	0,01	487	0.00 = On delay not in use
P2.5.3.4	DO2 OFF Delay	0.00	320.00	S	0.00	0,01	488	0.00 = On delay not in use
P2.5.2.5	ID.Bit Free DO	0.00	4000.00	ID.Bit	0.00	0,01	1217	

## 6.5.4 ANALOGUE OUTPUT 1

Table 19. Analogue output signals, G2.3.4

Code	Parameter	Min	Max	Unit	Default	Step	ID	Description
P2.5.4.1	lout 1 signal	AnOUT:0.1	AnOUT:E.10		0.1	0,1	464	Connect the AO1 signal to the analogue output of your choice with this parameter.
P2.5.4.2	lout Content	0	11		1	1	307	0 = Not used 1 = DC Voltage 2 = Drive Current 3 = Output Voltage 4 = Active Current 5 = Power 6 = Reactive Current 7 = Power Bidirectional 8 = AI1 9 = AI2 10 = FB Analogue Output 11 = Line Voltage 12 = FreqOut, bidirectional 13 = Value Control Out
P2.5.4.3	lout Filter Time	0	10	s	1,000	0,001	308	0 = No filtering
P2.5.4.4	lout Invert	0	1		0	1	309	0 = Not inverted 1 = Inverted
P2.5.4.5	lout Minimum	0	1		0	1	310	0 = 0 mA 1 = 4 mA
P2.5.4.6	lout Scale	10	1000	%	100	0,1	311	Percentage multiplier. Defines output when content is in maximum value
P2.5.4.7	lout Offset	-100	100	%	0,00	0,01	375	Add -1000 to 1000% to the analogue output.

## 6.5.5 ANALOGUE OUTPUT 2

Table 20. Analogue output signals, G2.3.4

Code	Parameter	Min	Max	Unit	Default	Step	ID	Description
P2.5.5.1	lout 2 signal	AnOUT:0.1	AnOUT:E.10		0.1	0,1	464	Connect the AO1 signal to the analogue output of your choice with this parameter.
P2.5.5.2	lout Content	0	11			1	307	0 = Not used 1 = DC Voltage 2 = Drive Current 3 = Output Voltage 4 = Active Current 5 = Power 6 = Reactive Current 7 = Power Bidirectional 8 = AI1 9 = AI2 10 = FB Analogue Output 11 = Line Voltage 12 = FreqOut, bidirectional 13 = Value Control Out
P2.5.5.3	lout Filter Time	0	10	s	0,020	0,001	308	0 = No filtering
P2.5.5.4	lout Invert	0	1		0	1	309	0 = Not inverted 1 = Inverted
P2.5.5.5	lout Minimum	0	1		0	1	310	0 = 0 mA 1 = 4 mA
P2.5.5.6	lout Scale	10	1000	%	100	0,1	311	Percentage multiplier. Defines output when content is in maximum value
P2.5.5.7	lout Offset	-100	100	%	0	0,01	375	Add -1000 to 1000% to the analogue output.

## 6.5.6 ANALOGUE OUTPUT 3

Table 21. Analogue output signals, G2.3.4

Code	Parameter	Min	Max	Unit	Default	Step	ID	Description
P2.5.6.1	lout 3 signal	AnOUT:0.1	AnOUT:E.10		0.1	0,1	464	Connect the AO1 signal to the analogue output of your choice with this parameter.
P2.5.6.2	lout Content	0	11		0	1	307	0 = Not used 1 = DC Voltage 2 = Drive Current 3 = Output Voltage 4 = Active Current 5 = Power 6 = Reactive Current 7 = Power Bidirectional 8 = AI1 9 = AI2 10 = FB Analogue Output 11 = Line Voltage 12 = FreqOut, bidirectional 13 = Value Control Out
P2.5.6.3	lout Filter Time	0	10	s	0,020	0,001	308	0 = No filtering
P2.5.6.4	lout Invert	0	1		0 / No Inversion	1	309	0 = Not inverted 1 = Inverted
P2.5.6.5	lout Minimum	0	1		0	1	310	0 = 0 mA 1 = 4 mA
P2.5.6.6	lout Scale	10	1000	%	100	0,1	311	Percentage multiplier. Defines output when content is in maximum value
P2.5.6.7	lout Offset	-100	100	%	0,00	0,01	375	Add -1000 to 1000% to the analogue output.

## 6.5.7 OPTIONS

Table 22.

Code	Parameter	Min	Max	Unit	Default	Step	ID	Description
P2.5.7.1	Output Inversion	0	65535		0	1	1806	
P2.5.7.2	DC Supervision Limit	0	1500	V	602	1	1454	
P2.5.7.3	MCB Close Mode	0	2		0	1	1607	0 = DC Voltage 1 = DC or Start command 2 = Start Command.
P2.5.7.4	MCB At Stop Command	0	1		0	1	1685	0 = Keep CB Closed 1 = Open CB
P2.5.7.5	MCB Close Delay	0.00	3.00		0.00	0,01	1513	Delay to CB RO
P2.5.7.6	Grid Code Breaker	0	2		0	1	4531	0 = MCB 1 1 = NET Contactor
P2.5.7.7	MCB Mechanical close Delay	0	3000	ms	0	1	1967	

## 6.6 LIMIT SETTINGS

### 6.6.1 CURRENT LIMIT

Table 23.

Code	Parameter	Min	Max	Unit	Default	Step	ID	Description
P2.6.1.1	Current Limit	0	Varies	A	Varies	Varies	107	Total current limit
P2.6.1.2	Short Circuit Level	0	800,1	%	800,0	0,01	1620	Disabled above 499.0%
P2.6.1.3	Short Circuit Time	0	5000	ms	0	1	1515	
P2.6.1.4	Bridge Current Limit	0	1		0	1	1517	0 = Enabled (FR) 1 = Disabled (INU)
P2.6.1.5	BiPhase fault voltage level	0.00	150.00	%	80,00	0,01	1518	
P2.6.1.6	Output Active Current Limit	0	300,0	%	150,0	0,1	1290	Generating Active Current limit in AFE mode to grid.
P2.6.1.7	Input Active Current Limit	0	300,0	%	150,0	0,1	1289	Motoring active current limit in AFE mode to DC-link.
P2.6.1.8	OverCurrentTripLim	0	1000,0	%	0,0	0,1	1094	Software Over Current Trip

### 6.6.2 POWER LIMIT

Table 24.

Code	Parameter	Min	Max	Unit	Default	Step	ID	Description
P2.6.2.1	Output PowerLimit	0	300	%	150	0,1	1288	Generating Power limit in AFE mode to grid.
P2.6.2.2	Input Power Limit	0	300	%	150	0,1	1287	Motoring Power limit in AFE mode to DC.
P2.6.2.3	Limit increase Rate	0	10000	%/s	100	1	1502	
P2.6.2.4	High Frequency Power Limit	0.00	100.00	Hz	0.00	0,01	1703	0.00 = Not Used.
P2.6.2.5	Stop Power Ramp Rate	-1,00	100,00	%/s	-0,01	0,01	1812	

### 6.6.3 FREQUENCY LIMIT

Table 25.

Code	Parameter	Min	Max	Unit	Default	Step	ID	Description
P2.6.3.1	Line Low Trip Limit	0.00	120.00	Hz	40,00	0,01	1717	F10 immediately if above
P2.6.3.2	Line High Trip Limit	0.00	120.00	Hz	70,00	0,01	1716	F10 immediately if below

### 6.6.4 MICRO GRID

Table 26.

Code	Parameter	Min	Max	Unit	Default	Step	ID	Description
P2.6.4.1	Current limit Min	-300.0	0.0	%	-150	0,1	1621	Island and uGrid mode
P2.6.4.2	Current limit Max	0.0	300.0	%	150	0,1	1622	Island and uGrid mode
P2.6.4.3	Max Limit Increase rate	0	10000	%/s	100	1	1502	
P2.6.4.4	Current limit Kp	0	1000		100	1	1623	
P2.6.4.5	Current Limit ti	0	1000	ms	32	1	1625	
P2.6.4.6	Current Limit Max Minimum	0.0	10.0	%	1,0	0,1	1890	
P2.6.4.7	Current Limit To Zero Mode	0	10		0	1	1539	0 = No Action 1 = At Stop State



**6.6.5 DC VOLTAGE**

Table 27.

Code	Parameter	Min	Max	Unit	Default	Step	ID	Description
P2.6.5.1	Under Voltage Limit	0.00	320.00	%	65.00	0,01	1524	
P2.6.5.2	Over voltage limit	0.00	320.00	%	120.00	0,01	1523	
P2.6.5.3	Brake Chopper	0	3		0	1	504	
P2.6.5.4	BrakeChopperLev	Varies	Varies	Vdc	Varies	1	1267	
P2.6.5.5	DC Limit Control Kp	0	32000		100	1	1525	
P2.6.5.6	DC Limit Control Ti	0	32000	ms	50	1	1526	
P2.6.5.7	HighMCBCloseLim	0	1300	Vdc	0	1	1251	
P2.6.5.8	LK Low DC	0	65535		0	1	1813	

**6.7 DRIVE CONTROL**

Table 28. Drive control, G2.6

Code	Parameter	Min	Max	Unit	Default	Step	ID	Description
P 2.7.1	Switching Freq	3.6	6	kHz	3.6	0,1	601	
P 2.7.2	AFE Options 1	0	65535		544	1	1463	
P 2.7.3	AFE Options 2	0	65535		0	1	1464	
P 2.7.4	AFE Options 3	0	65535		0	1	1466	
P 2.7.5	AFE Options 4	0	65535		0	1	1467	
P 2.7.6	Start Delay	0.10	3200	s	1.00	0,01	1500	
P 2.7.7	Modulator Type	0	4		1	1	1516	
P2.7.8	Control Options	0	65535		0	1	1707	
P2.7.9	Control Options 2	0	65535		0	1	1798	
P2.7.10	Operation Time	0	2^32		0	1	1855	

**6.7.1 AFE CONTROL**

Table 29. AFE Control, G2.7.9

Code	Parameter	Min	Max	Unit	Default	Step	ID	Description
P 2.7.11.1	Dynamic Support Kp	0	32000		0	1	1797	
P 2.7.11.2	Synch Kp	0	32000		2000	1	1457	
P 2.7.11.3	Synch Ti	0	1000		50	1	1458	
P 2.7.11.4	Active Current Kp	0	4000		400	1	1455	
P 2.7.11.5	Active Current Ti	0,0	100,0		1,5	1	1456	
P 2.7.11.6	Synch. Kp Start	0	10000		4000	1	1300	
P 2.7.11.7	Voltage Ctrl Kp	0	32000		200	1	1451	
P2.7.11.8	Voltage Ctrl Ti	0	1000	ms	50	1	1452	
P2.7.11.9	Modulator #2 DPWM Optimization	0	1		1	1	1682	
P2.7.11.10	AdvancedOptions1	0	65535		0	1	1560	
P2.7.11.11	AdvancedOptions2	0	65535		0	1	1561	
P2.7.11.12	AdvancedOptions4	0	65535		0	1	1563	
P2.7.11.13	AdvancedOptions5	0	65535		0	1	1564	
P2.7.11.14	AdvancedOptions6	0	65535		0	1	1565	

### 6.7.2 IDENTIFICATION

Table 30. Identification

Code	Parameter	Min	Max	Unit	Default	Step	ID	Description
P 2.7.12.1	IU Offset	-10000	10000		10000	1	668	
P 2.7.12.2	IV Offset	-10000	10000		0	1	669	
P 2.7.12.3	IW Offset	-10000	10000		0	1	670	
P 2.7.12.4	DCLinkMeasCalib	-2,00	2,00	%	0,00	0,01	549	

### 6.7.3 ACTIVE COMPENSATION

Table 31. DC Compensation

Code	Parameter	Min	Max	Unit	Default	Step	ID	Description
P 2.7.13.1	DC Ripple Compensation Kp	0	100		0	1	1900	
P 2.7.13.2	DC Ripple Compensation Phase	-360	360		0	1	1901	
P 2.7.13.3	DC Ripple Compensation frequency	0	0		300	1	1902	
P 2.7.13.4	HcompDroop	-32000	32000		100	1	1938	
P 2.7.13.5	HcompDroopHi	-32000	32000		100	1	1939	
P2.7.13.6	Id LCL Compensation	-50,0	50,0	%	0,0	0,1	4533	

### 6.8 MASTER/FOLLOWER

Code	Parameter	Min	Max	Unit	Default	Step	ID	Description
P2.8.1	MF Mode	0	6		0	1	1324	0 = Single Drive 1 = Master Standard 2 = Follower Standard 3 = Master DriveSynch 4 = Follower DriveSynch 5 = Master D2-Synch 6 = Follower D2-Synch
P2.8.2	Follower DC Ref	0	1		0	1	1081	
P2.8.3	MF License	0	65535		0	1	1994	
P2.8.4	Follower Fault	0	2		2	1	1542	

## 6.9 PROTECTIONS

### 6.9.1 GENERAL

Table 32. Protections, G2.9

Code	Parameter	Min	Max	Unit	Default	Step	ID	Description
P2.9.1.1	Thermistor Fault Response	0	3		2	1	732	0 = No response 1 = Warning 2 = Fault
P2.9.1.2	Overtemperature Response	2	5		2	1	1757	0 = No response 1 = Warning 2 = Fault 3 = Fault, MCB Open 4 = Fault, NC Open
P2.9.1.3	Overvoltage Response	2	5		2	1	1755	As Par. P2.9.1.2
P2.9.1.4	LCL Overtemperature	0	2		2	1	1505	As Par. P2.9.1.1
P2.9.1.5	Max Charge Time	0.00	30.00	s	5.00	0,01	1522	Charging time limit when drive charging options are used.
P2.9.1.6	MCB At Fault	0	1		0	1	1699	0 = No Action 1 = Open MCB
P2.9.1.7	Quick Stop Response	0	2		1 / Warning	1	1758	0 = No Indication 1 = Warning 2 = Fault
P2.9.1.8	Reactive Error Trip Limit	-300	300	%	7.5	0,1	1759	
P2.9.1.9	MCB Fault Delay	0.00	10.00	s	3.50	0,01	1521	
P2.9.1.10	Line Phase Supervision	0	4		0 / No Action	1	702	0 = No Action 1 = Warning 2 = Fault 3 = Fault & F10 One Phase 4 = F10 One Phase
P2.9.1.11	4 mA Fault Response	0	2		0 / No Action	1	700	0 = No Action 1 = Warning 2 = Fault
P2.9.1.12	Reactive Current Limit Response	0	2		1 / Warning	1	1981	0 = No Action 1 = Warning 2 = Fault
P2.9.1.13	Klixon Response	0	3		2	1	782	0 = No Action 1 = Warning, Warning 2 = Warning, Fault 3 = Fault, Fault
P2.9.1.14	Ambient Temp Response	0	2		1	1	784	0 = No Action 1 = Warning 2 = Fault
P2.9.1.15	Input Switch Response	0	2		2	1	785	0 = No Action 1 = Warning 2 = Fault
P2.9.1.16	FaultWarnIndicat	0	2		1	1	1940	0=Static 1=Toggle 2=Marine

## 6.9.2 PT-100

Table 33.

Code	Parameter	Min	Max	Unit	Default	Cust	Step	ID	Note
P2.9.2.1	No. of used inputs on board 1	0	5		0		1	739	0=Not used (ID Write) 1 = Sensor 1 in use 2 = Sensor 1 & 2 in use 3 = Sensor 1 & 2 & 3 in use 4 = Sensor 2 & 3 in use 5 = Sensor 3 in use
P2.9.2.2	Response to temperature fault	0	3		2		1	740	0=No response 1=Warning 2=Fault. 3=Fault, DC Off
P2.9.2.3	Board 1 warning limit	-30.0	200.0	C°	120.0		0,1	741	
P2.9.2.4	Board 1 fault limit	-30.0	200.0	C°	130.0		0,1	742	
P2.9.2.5	No. of uses inputs on board 2	0	5		0		1	743	0=Not used (ID Write) 1 = Sensor 1 in use 2 = Sensor 1 & 2 in use 3 = Sensor 1 & 2 & 3 in use 4 = Sensor 2 & 3 in use 5 = Sensor 3 in use
P2.9.2.6	Response to temperature fault	0	3		2		1	766	0=No response 1=Warning 2=Fault. 3=Fault, DC Off
P2.9.2.7	Board 2 warning limit	-30.0	200.0	C°	120.0		0,1	745	
P2.9.2.8	Board 2 fault limit	-30.0	200.0	C°	130.0		0,1	746	
P2.9.2.9.1	Channel 1B Warn	-30.0	200.0	C°	0.0		0,1	764	
P2.9.2.9.2	Channel 1B Fault	-30.0	200.0	C°	0.0		0,1	765	
P2.9.2.9.3	Channel 1C Warn	-30.0	200.0	C°	0.0		0,1	768	
P2.9.2.9.4	Channel 1C Fault	-30.0	200.0	C°	0.0		0,1	769	
P2.9.2.9.5	Channel 2B Warn	-30.0	200.0	C°	0.0		0,1	770	
P2.9.2.9.6	Channel 2B Fault	-30.0	200.0	C°	0.0		0,1	771	
P2.9.2.9.7	Channel 2C Warn	-30.0	200.0	C°	0.0		0,1	772	
P2.9.2.9.8	Channel 2C Fault	-30.0	200.0	C°	0.0		0,1	773	

## 6.9.3 EARTH FAULT

Table 34.

Code	Parameter	Min	Max	Unit	Default	Step	ID	Description
P2.9.3.1	Earth Fault Response	2	5		2 / Fault	1	1756	
P2.9.3.2	Earth Fault Level	0	100	%	50	1	1333	

## 6.9.4 FIELD BUS FAULT

Table 35.

Code	Parameter	Min	Max	Unit	Default	Step	ID	Description
P2.9.4.1	FB Fault response Slot D	0	6		2	1	733	
P2.9.4.2	FB Fault response Slot E	0	6		2	1	761	
P2.9.4.3	FB WD Time	0.00	30.00	s	0.00	0,01	1354	

**6.9.5 EXTERNAL FAULT**

Table 36.

Code	Parameter	Min	Max	Unit	Default	ID	Description
P2.9.5.1	External Fault 1	0	3		2 / Fault	701	
P2.9.5.2	External Fault 2	0	3		1 / Warning	1504	
P2.9.5.3	External Fault Delay	0.00	320.00	s	0.10	1506	

**6.9.6 GRID VOLTAGE D7**

Table 37.

Code	Parameter	Min	Max	Unit	Default	Step	ID	Description
P2.9.6.1	Voltage D7 Response	0	2		1	1	1626	
P2.9.6.2	Voltage Low Warning Limit	0.00	320.00	%	90.00	0,01	1893	
P2.9.6.3	Voltage Low Trip Limit	0.00	320.00	%	80.00	0,01	1899	
P2.9.6.4	Voltage High Warning Limit	0.00	320.00	%	110.00	0,01	1895	
P2.9.6.5	Voltage High Trip Limit	0.00	320.00	%	115.00	0,01	1799	
P2.9.6.6	Voltage Trip Delay	0.00	320.00	s	0.50	0,01	1898	

**6.9.7 GRID FREQUENCY**

Table 38.

Code	Parameter	Min	Max	Unit	Default	Step	ID	Description
P2.9.7.1	Freq. Supply Response	0	2		2	1	1627	
P2.9.7.2	Freq. D7 Response	0	2		1	1	1628	
P2.9.7.3	Freq. Low Warning Limit	0.00	320.00	%	95.00	0,01	1780	Low limit for e.g. Mot Pot function
P2.9.7.4	Freq. Low Trip Limit	0.00	320.00	%	94.00	0,01	1781	
P2.9.7.5	Freq. High Warning Limit	0.00	320.00	%	106.00	0,01	1783	High limit for e.g. Mot Pot function.
P2.9.7.6	Freq. High Trip Limit	0.00	320.00	%	110.00	0,01	1784	
P2.9.7.7	Freq. Trip Delay	0.00	320.00	s	0.50	0,01	1785	

**6.9.8 SUPPLY VOLTAGE**

Table 39.

Code	Parameter	Min	Max	Unit	Default	Step	ID	Description
P2.9.8.1	Voltage Supply Response	0	2		2	1	1629	
P2.9.8.2	Voltage Low Trip Limit	0.00	320.00	%	75.00	0,01	1891	
P2.9.8.3	Voltage Low Warning Limit	0.00	320.00	%	90.00	0,01	1880	
P2.9.8.4	Voltage High Warning Limit	0,00	320,00	%	120,00	0,01	1881	
P2.9.8.5	Voltage High Trip Limit	0.00	320.00	%	130.00	0,01	1992	

**6.9.9 OVER LOAD**

Table 40.

Code	Parameter	Min	Max	Unit	Default	Step	ID	Description
P2.9.9.1	Over Load Response	0	2		0	1	1838	0=No response 1=Warning 2=Fault
P2.9.9.2	Over Load Signal	0	2		0	1	1837	0=Not Used 1=Current % 2=Active Current 3=Reactive Current
P2.9.9.3	Over Load Maximum Input	0,0	300,0	%	150,0	0,1	1839	
P2.9.9.4	Over Load maximum Step	0	10000		200	1	1840	

**6.9.10 OPT-D7 PROTECTIONS**

Table 41. D7 protection settings, G2.9.10

Code	Parameter	Min	Max	Unit	Default	Step	ID	Description
P2.9.10.1	THD response	0	2		0	1	1672	0=No Action 1=Warning 2=Fault
P2.9.10.2	THD warning limit	0	5000	%	6,00	0,01	1673	
P2.9.10.3	THD fault limit	0	5000	%	10,00	0,01	1674	
P2.9.10.4	HF RMS response	0	2		0	1	1675	0=No Action 1=Warning 2=Fault
P2.9.10.5	HF RMS warning limit	0	4000	V	20,0	0,1	1676	
P2.9.10.6	HF RMS fault limit	0	4000	V	60,0	0,1	1677	

**6.9.11 COOLING PROTECTION**

Table 42. Cooling protection settings, G2.9

Code	Parameter	Min	Max	Unit	Default	Cust	Step	ID	Note
P2.9.11.1	Cooling Fault Response	1	2		2		1	762	0= No Action, Warning 1= Warning, Warning 2= Warning, Fault 3= No Action, Fault
P2.9.11.1	Cooling Fault delay	0.00	7.00	s	2.00		0,01	751	

**6.9.12 EXTRA**

Table 43.

Code	Parameter	Min	Max	Unit	Default	Step	ID	Description
P2.9.12	Fault Simulation	0	65535		0	1	1569	
P2.9.13	Reset Datalogger	0	4		0	1	1857	
P2.9.14	Disable Stop Lock	0	1		0	1	1086	

## 6.10 FIELDBUS

Table 44. Fieldbus, G2.10

Code	Parameter	Min	Max	Unit	Default	Step	ID	Description
P2.10.1	FB Actual Value Sel	0	10000		1108	1	1853	
P2.10.2	FB Data Out1 Sel	0	10000		1104	1	852	
P2.10.3	FB Data Out2 Sel	0	10000		1508	1	853	
P2.10.4	FB Data Out3 Sel	0	10000		1172	1	854	
P2.10.5	FB Data Out4 Sel	0	10000		1173	1	855	
P2.10.6	FB Data Out5 Sel	0	10000		56	1	856	
P2.10.7	FB Data Out6 Sel	0	10000		1174	1	857	
P2.10.8	FB Data Out7 Sel	0	10000		1125	1	858	
P2.10.9	FB Data Out8 Sel	0	10000		1157	1	859	
P2.10.10	FB Data Out9 Sel	0	10000		0	1	558	Data Out 9-16 visible only with correct HW and SW.
P2.10.11	FB Data Out10 Sel	0	10000		0	1	559	
P2.10.12	FB Data Out11 Sel	0	10000		0	1	560	
P2.10.13	FB Data Out12 Sel	0	10000		0	1	561	
P2.10.14	FB Data Out13 Sel	0	10000		0	1	562	
P2.10.15	FB Data Out14 Sel	0	10000		0	1	563	
P2.10.16	FB Data Out15 Sel	0	10000		0	1	564	
P2.10.17	FB Data Out16 Sel	0	10000		0	1	565	
P2.10.18	FB Data In 1 Sel	0	10000		0	1	876	
P2.10.19	FB Data In 2 Sel	0	10000		0	1	877	
P2.10.20	FB Data In 3 Sel	0	10000		0	1	878	
P2.10.21	FB Data In 4 Sel	0	10000		0	1	879	
P2.10.22	FB Data In 5 Sel	0	10000		0	1	880	
P2.10.23	FB Data In 6 Sel	0	10000		0	1	881	
P2.10.24	FB Data In 7 Sel	0	10000		0	1	882	
P2.10.25	FB Data In 8 Sel	0	10000		0	1	883	
P2.10.26	FB Data In 9 Sel	0	10000		0	1	550	Data In 9-16 visible only with correct HW and SW.
P2.10.27	FB Data In 10 Sel	0	10000		0	1	551	
P2.10.28	FB Data In 11 Sel	0	10000		0	1	552	
P2.10.29	FB Data In 12 Sel	0	10000		0	1	553	
P2.10.30	FB Data In 13 Sel	0	10000		0	1	554	
P2.10.31	FB Data In 14 Sel	0	10000		0	1	555	
P2.10.32	FB Data In 15 Sel	0	10000		0	1	556	
P2.10.33	FB Data In 16 Sel	0	10000		0	1	557	
P2.10.34	GSW Data	0	10000		68	1	897	
P2.10.35	State Machine	0	3		2	1	896	0 = Basic 1 = Standard 2 = Vacon AFE 1 3 = Vacon AFE 2
P2.10.36	Control Slot Selector	0	Varies		0	1	1440	0=Not Sel, 4=Slot D, 5=Slot E, 8=Slot D 16 PD, 9=Slot E 16 PD  Note: Options 8-9 visible only with correct HW and SW.
P2.10.37	SW B11 ID.Bit	0.00	4000.15		0.00	0,01	1907	
P2.10.38	SW B12 ID.Bit	0.00	4000.15		0.00	0,01	1908	
P2.10.39	SW B13 ID.Bit	0.00	4000.15		0.00	0,01	1909	
P2.10.40	SW B14 ID.Bit	0.00	4000.15		0.00	0,01	1910	

Code	Parameter	Min	Max	Unit	Default	Step	ID	Description
P2.10.41	uCW B12	0	10000		0	1	1934	
P2.10.42	uCW B13	0	10000		0	1	1935	
P2.10.43	uCW B14	0	10000		0	1	1936	
P2.10.44	uCW B15	0	10000		0	1	1937	

### 6.11 MICRO GRID

Table 45.

Code	Parameter	Min	Max	Unit	Default	Step	ID	Description
P2.11.1	Control Mode	0	6		0 / AFE	1	1531	0 = AFE 1 = Island 2 = Micro Grid 3 = Island-AFE 4 = Island-Micro Grid 5 = uGrid-AFE 6 = FreeSelect
P2.11.2	Frequency Droop	0	32	Hz	1,000	0,001	1534	
P2.11.3	Voltage Droop	0	320	%	5,00	0,01	1535	Reactive current drooping in percentage of P2.1.1 Grid Nom Voltage
P2.11.4	Start Power Mode	0	2		2	1	1503	0 = Zero power D7 1 = Zero Power F/O 2 = Drooping 3 = Isochron.Gen
P2.11.5	Voltage Rise Time	0	10000	ms	100	1	1541	
P2.11.6	Generator Mechanical Time Constant	0	32000	ms	0	1	1722	0 = Not used 1 >= Active Use 1000 ms as a starting point.
P2.11.7	Generator Speed Control Kp	0,0	3200,0	%/Hz	40,0	0,1	1723	
P2.11.8	Generator Speed Control Ti	0	32000	ms	500	1	1724	

Code	Parameter	Min	Max	Unit	Default	Step	ID	Description
P2.11.9.1	AFE Mode 1	0	6		0 / AFE	1	1616	
P2.11.9.2	AFE Mode 2	0	6		1 / Island	1	1617	
P2.11.9.3	AFE Mode 3	0	6		2 / Micro Grid	1	1713	



**6.12 SYNCHRONISATION TO EXTERNAL GRID***Table 46.*

Code	Parameter	Min	Max	Unit	Default	Step	ID	Description
P2.12.1	Synch. Offset	-3172	3171		0	1	1601	Used to compensate for transformer angle offset. (3172 equals 180 degrees offset).
P2.12.2	Synch Reference	-3170	3170		0	1	1611	Gives synchronisation point for synch error.
P2.12.3	Synch Kp	0	32000		500	1	1612	
P2.12.4	Synch Ti	0	32000		0	1	1613	
P2.12.5	Synch. Hysteresis	-3170	3170		50	1	1614	
P2.12.6	Synch Stop Mode	0	1		0 / Stay Run	1	1618	When stop is selected, drive will go to stop mode when feedback from shore contactor.
P2.12.7	NET Close Delay	0	1000	ms	0	1	1624	0 = Drive will use solely NET Breaker feedback.
P2.12.8	NET Open Delay	0	1000	ms	20	1	1634	If ID1624 is zero this parameter has no affect.

**6.13 RESERVED***Table 47.*

Code	Parameter	Min	Max	Unit	Default	ID	Description

## 6.14 ID CONTROL FUNCTIONS

### 6.14.1 VALUE CONTROL

Table 48. Power reference input signal selection, G2.2.8

Code	Parameter	Min	Max	Unit	Default	Cust	Step	ID	Description
P2.14.1.1	Control Input Signal ID	0	10000	ID	0		1	1580	
P2.14.1.2	Control Input Off Limit	-32000	32000		0		1	1581	
P2.14.1.3	Control Input On Limit	-32000	32000		0		1	1582	
P2.14.1.4	Control Output Off Value	-32000	32000		0		1	1583	
P2.14.1.5	Control Output On Value	-32000	32000		0		1	1584	
P2.14.1.6	Control Output Signal ID	0	10000	ID	0		1	1585	
P2.14.1.7	Control Mode	0	6		0		1	1586	0 = SR ABS 1 = Scale ABS 2 = Scale INV ABS 3 = SR 4 = Scale 5 = Scale INV 6 = XY-Plot
P2.14.1.8	Control Output Filtering rime	0.000	32.000	s	0.000		0,001	1721	

#### 6.14.1.1 XY-Plot

Table 49. XY-Plot parameters

Code	Parameter	Min	Max	Unit	Default	Cust	Step	ID	Description
P2.9.1.9.1	X Value 01	-32000	32000		0		1	3801	
P2.9.1.9.2	Y Value 01	-32000	32000		0		1	3813	
P2.9.1.9.3	X Value 02	-32000	32000		0		1	3802	
P2.9.1.9.4	Y Value 02	-32000	32000		0		1	3814	
P2.9.1.9.5	X Value 03	-32000	32000		0		1	3803	
P2.9.1.9.6	Y Value 03	-32000	32000		0		1	3815	
P2.9.1.9.7	X Value 04	-32000	32000		0		1	3804	
P2.9.1.9.8	Y Value 04	-32000	32000		0		1	3816	
P2.9.1.9.9	X Value 05	-32000	32000		0		1	3805	
P2.9.1.9.10	Y Value 05	-32000	32000		0		1	3817	
P2.9.1.9.11	X Value 06	-32000	32000		0		1	3806	
P2.9.1.9.12	Y Value 06	-32000	32000		0		1	3818	
P2.9.1.9.13	X Value 07	-32000	32000		0		1	3807	
P2.9.1.9.14	Y Value 07	-32000	32000		0		1	3819	
P2.9.1.9.15	X Value 08	-32000	32000		0		1	3808	
P2.9.1.9.16	Y Value 08	-32000	32000		0		1	3820	
P2.9.1.9.17	X Value 09	-32000	32000		0		1	3809	
P2.9.1.9.18	Y Value 09	-32000	32000		0		1	3821	
P2.9.1.9.19	X Value 10	-32000	32000		0		1	3810	
P2.9.1.9.20	Y Value 10	-32000	32000		0		1	3822	
P2.9.1.9.21	X Value 11	-32000	32000		0		1	3823	
P2.9.1.9.22	Y Value 11	-32000	32000		0		1	3811	
P2.9.1.9.23	X Value 12	-32000	32000		0		1	3812	
P2.9.1.9.24	Y Value 12	-32000	32000		0		1	3824	

**6.14.2 DIN ID CONTROL 1***Table 50. DIN ID control parameters, G2.2.8*

Code	Parameter	Min	Max	Unit	Default	Cust	Step	ID	Description
P2.14.2.1	ID Control DIN	0.1	E.10		0.1		0,1	1570	Slot Board input No. If 0.1 ID61 can be controlled from FB
P2.14.2.2	Controlled ID	0	10000	ID	0		1	1571	Select ID that is controlled by digital input
P2.14.2.3	False value	-32000	32000		0		1	1572	Value when DI is low
P2.14.2.4	True value	-32000	32000		0		1	1573	Value when DI is high

**6.14.3 DIN ID CONTROL 2***Table 51. DIN ID control parameters, G2.2.8*

Code	Parameter	Min	Max	Unit	Default	Cust	Step	ID	Description
P2.14.3.1	ID Control DIN	0.1	E.10		0.1		0,1	1590	Slot Board input No. If 0.1 ID61 can be controlled from FB
P2.14.3.2	Controlled ID	0	10000	ID	0		1	1575	Select ID that is controlled by digital input
P2.14.3.3	False value	-32000	32000		0		1	1592	Value when DI is low
P2.14.3.4	True value	-32000	32000		0		1	1593	Value when DI is high

**6.14.4 DIN ID CONTROL 3***Table 52. DIN ID control parameters, G2.2.8*

Code	Parameter	Min	Max	Unit	Default	Cust	Step	ID	Description
P2.14.4.1	ID Control DIN	0.1	E.10		0.1		0,1	1578	Slot Board input No. If 0.1 ID61 can be controlled from FB
P2.14.4.2	Controlled ID	0	10000	ID	0		1	1579	Select ID that is controlled by digital input
P2.14.4.3	False value	-32000	32000		0		1	1594	Value when DI is low
P2.14.4.4	True value	-32000	32000		0		1	1596	Value when DI is high

**6.14.5 DIN ID CONTROL 4***Table 53. DIN ID control parameters, G2.2.8*

Code	Parameter	Min	Max	Unit	Default	Cust	Step	ID	Description
P2.14.5.1	ID Control DIN	0.1	E.10		0.1		0,1	1930	Slot Board input No. If 0.1 ID61 can be controlled from FB
P2.14.5.2	Controlled ID	0	10000	ID	0		1	1931	Select ID that is controlled by digital input
P2.14.5.3	False value	-32000	32000		0		1	1932	Value when DI is low
P2.14.5.4	True value	-32000	32000		0		1	1933	Value when DI is high

**6.14.6 ID CONTROLLED DIGITAL OUTPUT 1***Table 54.*

Code	Parameter	Min	Max	Unit	Default	Cust	Step	ID	Description
P2.14.6.1	ID.Bit Free DO	0.00	2000.15	ID.Bit	0.00		0,01	135	
P2.14.6.2	Free DO Sel	0.1	E.10		0.1		0,1	1326	

**6.14.7 ID CONTROLLED DIGITAL OUTPUT 1***Table 55.*

Code	Parameter	Min	Max	Unit	Default	Cust	Step	ID	Description
P2.14.6.1	ID.Bit Free DO	0.00	2000.15	ID.Bit	0.00		0,01	1386	
P2.14.6.2	Free DO Sel	0.1	E.10		0.1		0,1	1325	

**6.15 AUTO FAULT RESET***Table 56.*

Code	Parameter	Min	Max	Unit	Default	Step	ID	Description
P2.15.1	Wait Time	0.00	60.00	s	0.50	0,01	717	
P2.15.2	Trial Time	0.00	120.00	s	30.00	0,01	718	
P2.15.3	Over voltage tries	0	3		0	1	721	
P2.15.4	Over current tries	0	3		0	1	722	
P2.15.5	External fault tries	0	10		0	1	725	

## 6.16 GRID VOLTAGE PI

Table 57. Grid voltage PI function

Code	Parameter	Min	Max	Unit	Default	Cust	Step	ID	Description
P2.16.1	PID Activation	0.1	E.10	DigIn	0.1		0,1	1807	Digital input to activate PI controller
P2.16.2	PI controller gain	0.0	1000.0	%	200.0		0,1	118	PI controller gain
P2.16.3	PI controller I-time	0.00	320.00	s	0.05		0,01	119	PI controller I-time
P2.16.4	PI Max Adjust	-32000	32000	%	5.00		0,01	360	PI High limit
P2.16.5.1	PI Frequency Low Limit	0.00	320.00	%	95.00		0,01	1630	
P2.16.5.2	PI Frequency High Limit	0.00	320.00	%	102.00		0,01	1631	
P2.16.5.3	PI Voltage Low Limit	0.00	320.00	%	90.00		0,01	1632	
P2.16.5.4	PI Voltage High Limit	0.00	320.00	%	110.00		0,01	1633	

### 6.17 GRID CODE PARAMETERS

Code	Parameter	Min	Max	Unit	Default	Cust	Step	ID	Description
P2.17.1	GGC License	0	65535		0		1	3201	
P2.17.2	Set Grid Code	0	1		0		1	3401	1 = Factory Defaults
P2.17.3	EnableGridCode	0	3		0		1	3254	0 = Disabled 1 = Reserved 2 = Enabled 3 = Simulation

#### 6.17.1 ANTI-ISLANDING

Code	Parameter	Min	Max	Unit	Default	Cust	Step	ID	Description
P2.17.4.1	Anti-islanding	0	1		0		1	3250	
P2.17.4.2	LF MaxChangeRate	0,00	20,00	Hz/s			0,01	3322	
P2.17.4.3	High Volt AI	0	320	%	0		0,01	3404	
P2.17.4.4	Low Volt AI	0	320	%	0		0,01	3405	
P2.17.4.5	High Freq AI	0	320	%	110,00		0,01	3406	
P2.17.4.6	Low Freq AI	0	320	%	80,00		0,01	3407	
P2.17.4.7	AI Trip Deay	0	10000	ms	50		1	3408	
P2.17.4.8	Anti-Islanding Kp	0	32000		0		1	3426	

#### 6.17.2 FRT (FAULT RIDE-THROUGH)

Code	Parameter	Min	Max	Unit	Default	Cust	Step	ID	Description
P2.17.5.1	FRT Function	0	4		0		1	3251	0 = Disabled; Both 1 = Enabled; Limits 2 = Enabled; Curve 3 = Enabled; Neither 4 = Enabled; Both
P2.17.5.2	ReactivInjection	0	2		0		1	3252	
P2.17.5.3	Symmetrical Reactive	0	1		1		1	3323	

##### 6.17.2.1 FRT Timer

Code	Parameter	Min	Max	Unit	Default	Cust	Step	ID	Description
P2.17.5.4.1	Voltage X6	0	110	%	80,00		0,01	3284	
P2.17.5.4.2	Time Y6	0	20000	ms	2500		1	3285	
P2.17.5.4.3	Voltage X5	0	110	%	30,00		0,01	3282	
P2.17.5.4.4	Time Y5	0	20000	ms	400		1	3283	
P2.17.5.4.5	Voltage X4	0	110	%	0		0,01	3280	
P2.17.5.4.6	Time Y4	0	20000	ms	0		1	3281	
P2.17.5.4.7	Voltage X3	0	110	%	0		0,01	2278	
P2.17.5.4.8	Time Y3	0	20000	ms	0		1	3279	
P2.17.5.4.9	Voltage X2	0	110	%	0		0,01	3276	
P2.17.5.4.10	Time Y2	0	20000	ms	0		1	3277	
P2.17.5.4.11	Voltage X1	0	110	%	0		0,01	3274	
P2.17.5.4.12	Time Y1	0	20000	ms	0		1	3275	
P2.17.5.4.13	Voltage X0	0	110	%	0		0,01	3272	
P2.17.5.4.14	Time Y0	0	20000	ms	0		1	3273	

**6.17.3 RECONNECTION**

Code	Parameter	Min	Max	Unit	Default	Cust	Step	ID	Description
P2.17.6.1	ReConnectTime	1,1	1000	s	2		0,001	3253	
P2.17.6.2	ReConnTimeStop	1,1	1000	s	2		0,001	3255	
P2.17.6.3	ReConRampUpRate	-1	320	%/s	20		0,01	3297	
P2.17.6.4	RampReleaseDelay	0	32000	ms	600		1	3421	
P2.17.6.5	LF OK High	0	200	%	0		0,01	3287	
P2.17.6.6	LF OK Low	0	110	%	0		0,01	3286	
P2.17.6.7	LV OK High	0	200	%	0		0,01	3289	
P2.17.6.8	LV OK Low	0	110	%	0		0,01	3288	
P2.17.6.9	Line OK Delay	0	20000	ms	0		1	3290	

**6.17.4 LINE VOLTAGE TRIP LIMITS**

Code	Parameter	Min	Max	Unit	Default	Cust	Step	ID	Description
P2.17.7.1	Voltage Monitor	0	2		1		1	3364	0 = Average 1 = Phase Min Max 2 = Ave and BiPhase
P2.17.7.2	LV High 1	0	200	%	115		0,01	3256	
P2.17.7.3	LV High 1 Delay	0	60000	ms	50		1	3257	
P2.17.7.4	LV High 1 Plim	0	300	%	-1,0		0,1	3412	
P2.17.7.5	LV High 2	0	200	%	0		0,01	3258	
P2.17.7.6	LV High 2 Delay	0	120000	ms	0		1	3259	
P2.17.7.7	LV High 2 Plim	0	300	%	-1,0		0,1	3413	
P2.17.7.8	LV High 3	0	200	%	0		0,01	3361	
P2.17.7.9	LV High 3 Delay	0	120000	ms	0		1	3362	
P2.17.7.10	LV High 3 Plim	0	300	%	-1,0		0,1	3363	
P2.17.7.11	LV Low 1	0	200	%	0		0,01	3260	
P2.17.7.12	LV Low 1 Delay	0	120000	ms	0		1	3261	
P2.17.7.13	LV Low 1 Plim	0	300	%	-1,0		0,1	3414	
P2.17.7.14	LV Low 2	0	200	%	80		0,01	3262	
P2.17.7.15	LV Low 2 Delay	0	120000	ms	50		1	3263	
P2.17.7.16	LV Low 2 Plim	0	300	%	-1,0		0,1	3415	
P2.17.7.17	LV Low 3	0	200	%	0		0,01	3365	
P2.17.7.18	LV Low 3 Delay	0	120000	ms	0		1	3366	
P2.17.7.19	LV Low 3 Plim	0	300	%	-1,0		0,1	3367	
P2.17.7.20	LV Low 4	0	200	%	0		0,01	3416	
P2.17.7.21	LV Low 4 Delay	0	120000	ms	160		1	3417	
P2.17.7.22	LV Low 4 Plim	0	300	%	-1,0		0,1	3418	
P2.17.7.23	10 Min Average High Voltage	0	200	%	0,00		0,01	3353	
P2.17.7.24	10 min Average trip delay	0	10000	ms	50		1	3376	
P2.17.7.25	Voltage Response Time	0	500	ms	0		1	3410	
P2.17.7.26	Plim Down Rate	-100	32000	%/s	100		1	3419	

**6.17.5 LINE FREQUENCY TRIP LIMITS**

Code	Parameter	Min	Max	Unit	Default	Cust	Step	ID	Description
P2.17.8.1	Frequency Monitor	0	1		0		1	3423	0 = Normal 1 = Fast Short
P2.17.8.2	LF High 1	0	200	%	103		0,01	3264	
P2.17.8.3	LF High 1 Delay	0	1200000	ms	50		1	3265	
P2.17.8.4	LF High 2	0	200	%	0		0,01	3266	
P2.17.8.5	LF High 2 Delay	0	1200000	ms	0		1	3267	
P2.17.8.6	LF High 3	0	200	%	0		0,01	3368	
P2.17.8.7	LF High 3 Delay	0	1200000	ms	0		1	3369	
P2.17.8.8	LF Low 1	0	200	%	0		0,01	3268	
P2.17.8.9	LF Low 1 Delay	0	1200000	ms	0		1	3269	
P2.17.8.10	LF Low 2	0	200	%	95		0,01	3270	
P2.17.8.11	LF Low 2 Delay	0	1200000	ms	50		1	3271	
P2.17.8.12	LF Low 3	0	200	%	0		0,01	3370	
P2.17.8.13	LF Low 3 Delay	0	1200000	ms	0		1	3371	
P2.17.8.14	LF MaxChangeRate	0	20	Hz/s	0,00		0,01	3514	
P2.17.8.15	Frequency Response Time	0	500	ms	0		1	3399	
P2.17.8.16	Time Off Cycles	0	10	x	2		1	3411	



**6.17.6 DYNAMIC REACTIVE CURRENT INJECTION**

Code	Parameter	Min	Max	Unit	Default	Cust	Step	ID	Description
P2.17.9.1	UV Reactive Mode	0	1		0 / Linear		1	3314	
P2.17.9.2	OV Reactive Mode	0	1		0 / Linear		1	3377	

**6.17.6.1 Linear Under Voltage**

Code	Parameter	Min	Max	Unit	Default	Cust	Step	ID	Description
P2.17.9.3.1	UV High Corner	0	200	%	0		0,01	3291	
P2.17.9.3.2	UV Low Corner	0	200	%	0		0,01	3292	
P2.17.9.3.3	UV React. Ref	0	150	%	0		0,1	3293	
P2.17.9.3.4	UV Bi React. Ref	0	150	%	0		0,1	3294	

**6.17.6.2 Linear Over Voltage**

Code	Parameter	Min	Max	Unit	Default	Cust	Step	ID	Description
P2.17.9.4.1	OV Low Corner	0	150	%	0		0,01	3300	
P2.17.9.4.2	OV Max Reactiv	0	150	%	0		0,1	3301	
P2.17.9.4.3	OV React Slope	0	150	%	0		0,01	3302	
P2.17.9.4.4	OV React PlogIn	0	150	%	0		0,1	3303	
P2.17.9.4.5	OV React PlogOut	0	150	%	0		0,1	3329	

**6.17.6.3 Power Lock Under Voltage**

Code	Parameter	Min	Max	Unit	Default	Cust	Step	ID	Description
P2.17.9.5.1	UV PowerLockIn	0	200	%	0		0,1	3315	
P2.17.9.5.2	UV PowerLockOut	0	200	%	0		0,1	3316	
P2.17.9.5.3	UV Power Log In Mode	0	1		0		1	3372	0 = VoltageLevlTrig 1 = Linear
P2.17.9.5.4	UV High Corner	0	200	%	0		0,01	3515	
P2.17.9.5.5	UV Low Corner	0	200	%	0		0,01	3516	
P2.17.9.5.6	UV LockOutVotag	0	200	%	0		0,01	3317	
P2.17.9.5.7	UVReacRefHighCor	0	200	%	0		0,1	3318	
P2.17.9.5.8	UV React. MaxRef	0	150	%	0		0,1	3518	
P2.17.9.5.9	UV Bi ReactMaxRef	0	150	%	0		0,1	3519	
P2.17.9.5.10	UV React. Start V	0	230	%	0		0,01	3444	

**6.17.6.4 Power Lock In/Out Over Voltage**

Code	Parameter	Min	Max	Unit	Default	Cust	Step	ID	Description
P2.17.9.6.1	OV PowerLockIn	0	200	%	0		0,1	3378	
P2.17.9.6.2	OV PowerLockOut	0	200	%	0		0,1	3379	
P2.17.9.6.3	OV Power Log In Mode	0	1		0		1	3380	0 = VoltageLevlTrig 1 = Linear
P2.17.9.6.4	OV Low Corner	0	150	%	0		0,01	3519	
P2.17.9.6.5	OV High Corner	0	200	%	0		0,01	3320	
P2.17.9.6.6	OV LockOutVotag	0	200	%	0		0,01	3319	
P2.17.9.6.7	OVReac Half Ref	0	200	%	0		0,1	3321	
P2.17.9.6.8	OV Max Reactiv	0	150	%	0		0,1	3543	
P2.17.9.6.9	OV React.Start V	0	200	%	0		0,01	3445	

### 6.17.6.5 Dynamic Grid Support

Code	Parameter	Min	Max	Unit	Default	Cust	Step	ID	Description
P 2.17.9.7.1	OV Low Corner	0	320	%	0		0,01	3501	
P 2.17.9.7.2	UV High Corner	0	320	%	0		0,01	3502	
P 2.17.9.7.3	PosSeqSlope	0	10	%/%	2,00		0,01	3504	
P 2.17.9.7.4	NegSeqSlope	0	10	%/%	2,00		0,01	3505	
P 2.17.9.7.5	SlopeMaxReactive	0	170	%	100,0		0,1	3503	
P 2.17.9.7.6	SudPosChanLim	-1	20	%	10,00		0,01	3506	
P 2.17.9.7.7	SudNegChanLim	-1	20	%	10,00		0,01	3507	
P 2.17.9.7.8	RampZeroTime	0	60	s	5,00		0,01	3508	
P 2.17.9.7.9	ResetHysteresis	-10	10	%	1,50		0,01	3509	
P2.17.9.7.10	Sudden Off Delay	0	32	s	5,000		0,001	3510	

**6.17.7 REACTIVE POWER CONTROL****6.17.7.1 Q(U) Power**

Code	Parameter	Min	Max	Unit	Default	Cust	Step	ID	Description
P2.17.10.1.1	High Max Q Power	-300	300	%	0,0		0,1	3341	
P2.17.10.1.2	High Max Voltage	0	200	%	115,00		0,01	3340	
P2.17.10.1.3	High Min Voltage	0	200	%	105,00		0,01	3339	
P2.17.10.1.4	Low Max Voltage	0	200	%	90,00		0,01	3343	
P2.17.10.1.5	Low Min Voltage	0	200	%	80,00		0,01	3342	
P2.17.10.1.6	Low Max Q Power	-300	300	%	0,0		0,1	3344	
P2.17.10.1.7	PowerOffsetToVac	0,00	20,00	%	0,00		0,01	3557	
P2.17.10.1.8	VacOffsetPQU	-20	20	%	0,00		0,01	3558	
P2.17.10.1.9	Vac Dead-band	0	5,00	%	0,00		0,01	3559	

**6.17.7.2 Q(U) Curve**

Code	Parameter	Min	Max	Unit	Default	Cust	Step	ID	Description
P2.17.10.2.1	Voltage 01	0	320	%	0		0,01	3385	
P2.17.10.2.2	Q Power 01	-300	300	%	0		0,1	3391	
P2.17.10.2.3	Voltage 02	0	320	%	0		0,01	3386	
P2.17.10.2.4	Q Power 02	-300	300	%	0		0,1	3392	
P2.17.10.2.5	Voltage 03	0	320	%	0		0,01	3387	
P2.17.10.2.6	Q Power 03	-300	300	%	0		0,1	3393	
P2.17.10.2.7	Voltage 04	0	320	%	0		0,01	3388	
P2.17.10.2.8	Q Power 04	-300	300	%	0		0,1	3394	
P2.17.10.2.9	Voltage 05	0	320	%	0		0,01	3389	
P2.17.10.2.10	Q Power 05	-300	300	%	0		0,1	3395	
P2.17.10.2.11	Voltage 06	0	320	%	0		0,01	3390	
P2.17.10.2.12	Q Power 06	-300	300	%	0		0,1	3396	

**6.17.7.3 Q(P) curve**

Code	Parameter	Min	Max	Unit	Default	Cust	Step	ID	Description
P 2.17.10.3.1	Power 01	-300	300	%	0,0		0,1	3520	
P 2.17.10.3.2	QP Power 01	-300	300	%	0,0		0,1	3530	
P 2.17.10.3.3	Power 02	-300	300	%	0,0		0,1	3521	
P 2.17.10.3.4	QP Power 02	-300	300	%	0,0		0,1	3531	
P 2.17.10.3.5	Power 03	-300	300	%	0,0		0,1	3522	
P 2.17.10.3.6	QP Power 03	-300	300	%	0,0		0,1	3532	
P 2.17.10.3.7	Power 04	-300	300	%	0,0		0,1	3523	
P 2.17.10.3.8	QP Power 04	-300	300	%	0,0		0,1	3533	
P 2.17.10.3.9	Power 05	-300	300	%	0,0		0,1	3524	
P 2.17.10.3.10	QP Power 05	-300	300	%	0,0		0,1	3534	
P 2.17.10.3.11	Power 06	-300	300	%	0,0		0,1	3525	
P 2.17.10.3.12	QP Power 06	-300	300	%	0,0		0,1	3535	
P 2.17.10.3.13	Power 07	-300	300	%	0,0		0,1	3526	
P 2.17.10.3.14	QP Power 07	-300	300	%	0,0		0,1	3536	
P 2.17.10.3.15	Power 08	-300	300	%	0,0		0,1	3527	
P 2.17.10.3.16	QP Power 08	-300	300	%	0,0		0,1	3537	
P 2.17.10.3.17	Power 09	-300	300	%	0,0		0,1	3528	
P 2.17.10.3.18	QP Power 09	-300	300	%	0,0		0,1	3538	
P 2.17.10.3.19	Power 10	-300	300	%	0,0		0,1	3529	
P 2.17.10.3.20	QP Power 10	-300	300	%	0,0		0,1	3539	

#### 6.17.7.4 Options

Code	Parameter	Min	Max	Unit	Default	Cust	Step	ID	Description
P2.17.10.4.1	Reactiv. Out TC	0,00	300,00	s	0,00		0,01	3546	

### 6.17.8 POWER LIMIT/REFERENCE

#### 6.17.8.1 General

Code	Parameter	Min	Max	Unit	Default	Cust	Step	ID	Description
P2.17.11.1.1	Power RampUp Rate	-1,00	320,00	%/s	50,00		0,01	3324	Negative value means no limitation in power increase.
P2.17.11.1.2	GC Max Power	0,0	300,0	%	105,0		0,1	3397	
P2.17.11.1.3	GC Min Power	0,0	300,0	%	105,0		0,1	3439	
P2.17.11.1.4	Stop Power Ramp Rate	-1,00	200,00	%/s	200,00		0,1	3555	

#### 6.17.8.2 High Frequency Power Limit

Code	Parameter	Min	Max	Unit	Default	Cust	Step	ID	Description
P2.17.11.2.1	HighFreqModes	0	1		0		1	3307	0 = High Limit 1 = Minimum
P2.17.11.2.2	HighFreqLowCornr	0	200	%	0,00		0,01	3295	
P2.17.11.2.3	HighFreqPLimSlop	-1	300	%/Hz	50,0		0,1	3239	End corner mode activated by setting this to zero -> - P2.17.11.1.7 - P2.17.11.1.8
P2.17.11.2.4	HighFreqLockOut	0	150	%	0,00		0,01	3308	
P2.17.11.2.5	HighFreqPLimRamp	-1	320	%/s	-1,00		0,01	3298	
P2.17.11.2.6	HighFreqPReleDel	0	1000000	ms	50		1	3299	
P2.17.11.2.7	HighLFFulIPReDe	0	400000	ms	0		1	3374	
P2.17.11.2.8	HighFreqLimOnDel	0	3000	ms	100		1	3402	
P2.17.11.2.9	HighFreqHigCornr	0	200	%	0,00		0,01	3296	
P2.17.11.2.10	HighFreqPowRatio	0	100	%	0,0		0,1	3309	

#### 6.17.8.3 High Voltage Power Limit

Code	Parameter	Min	Max	Unit	Default	Cust	Step	ID	Description
P2.17.11.3.1	Limit Mode	0	1		0		1	3360	0 = High Limit 1 = Minimum
P2.17.11.3.2	Log In Voltage	0,00	320,00	%	0		0,01	3325	
P2.17.11.3.3	Log Out Voltage	0,00	320,00	%	0		0,01	3326	
P2.17.11.3.4	Limit Slope	-1,0	3200,0	%/%	0,0		0,1	3327	
P2.17.11.3.5	PLimReleaseDelay	0	1200000	ms	0		1	3424	
P2.17.11.3.6	PLimRelRAmpRAte	-1	320	%/s	-0,01		0,01	3425	

#### 6.17.8.4 Low Voltage Charge Limit

Code	Parameter	Min	Max	Unit	Default	Cust	Step	ID	Description
P2.17.11.4.1	P Charge Max Voltage	0	200	%	0		0,01	3347	
P2.17.11.4.2	P Charge Min Voltage	0	200	%	0		0,01	3348	

**6.17.8.5** Low Frequency Charge Limit

Code	Parameter	Min	Max	Unit	Default	Cust	Step	ID	Description
P2.17.11.5.1	P Charge Limit mode	0	3		1		1	3354	0 = High Limit 1 = Minimum
P2.17.11.5.2	P Charge Max Freq	0	200	%	0,00		0,01	3349	
P2.17.11.5.3	P Charge Min Freq	0	200	%	0,00		0,01	3350	
P2.17.11.5.4	P Charge Log Out Freq	0	200	%	0,00		0,01	3351	
P2.17.11.5.5	P Charge Log Out Delay	0	1000000	ms	50		1	3352	
P2.17.11.5.6	P Charge Release Power Rate	-1	300	%/s	50,00		0,01	3355	
P2.17.11.5.7	PchargeOnDelay	0	3000	ms	50		1	3403	

**6.17.9 POWER REFERENCE****6.17.9.1 Low Frequency Power Reference**

Code	Parameter	Min	Max	Unit	Default	Cust	Step	ID	Description
P2.17.12.1.1	Power Increase Log In Frequency	0,00	200,00	%	0,00		0,01	3334	
P2.17.12.1.2	Power Increase Log Off Frequency	0,00	200,00	%	0,00		0,01	3437	
P2.17.12.1.3	Power Increase Slope	0,0	200,0	%/%	0,0		0,1	3335	
P2.17.12.1.4	Power Increase Off Ramp	-1,00	320,00	%	-1,00		0,01	3427	
P2.17.12.1.5	Power Increase Off Delay	0	600	s	0,000		0,001	3438	
P2.17.12.1.6	Power Increase Max	0	300,0	%	300,0		0,1	3336	
P2.17.12.1.7	Power Increase Low Frequency	0	200,00	%	0,00		0,01	3441	
P2.17.12.1.8	Power Increase Set Power Frequency	0	200,00	%	0,00		0,01	3443	
P2.17.12.1.9	Power Stop Charging Frequency	0,00	200,00	%	0,00		0,01	3552	
P2.17.12.1.10	Knee Point Increase	0	1		0		1	3553	

**6.17.9.2 High Frequency Power Reference**

Code	Parameter	Min	Max	Unit	Default	Cust	Step	ID	Description
P 2.17.12.2.1	PowDecLogInFreq	0,00	200,00	%	0,00		0,01	3428	
P 2.17.12.2.2	PowDecLogOffFreq	0,00	200,00	%	0,00		0,01	3436	
P 2.17.12.2.3	PowerDecSlope	0,0	3200,0	%/%	0,0		0,1	3429	
P 2.17.12.2.4	PowerDecOffRamp	-1,00	320,00	%/s	-1,00		0,01	3431	
P 2.17.12.2.5	PowerDecOffDelay	0,0	600	s	0,000		0,001	3435	
P 2.17.12.2.6	PowerDec Max	0,0	300,0	%	300,0		0,1	3430	
P 2.17.12.2.7	PowerDecHighFreq	0,00	200,00	%	0,00		0,01	3442	
P 2.17.12.2.8	PowDecTransFreq	0,00	200,00	%	0,00		0,01	3551	

**6.17.9.3 High Voltage Power Reference**

Code	Parameter	Min	Max	Unit	Default	Cust	Step	ID	Description
P 2.17.12.3.1	HVPrefLowVolt	0,00	200,00	%	0,00		0,01	3432	
P 2.17.12.3.2	HV Power Ref	-300,0	300,0	%	0,0		0,1	3433	
P 2.17.12.3.3	HV Power Ramp	-1,00	320,00	%/s	-1,00		0,01	3434	

**6.17.9.4 Options**

Code	Parameter	Min	Max	Unit	Default	Cust	Step	ID	Description
P2.17.12.4.1	Power Ref Ramp	-1,00	320,00	%/s	50,00		0,01	3449	

**6.17.10 COS PHII CONTROL**

Code	Parameter	Min	Max	Unit	Default	Cust	Step	ID	Description
P2.17.13.1	CosPhiiMode	0	3		0		1	3345	0 = Direct Reference 1 = Volt LogIn LogOut 2 = Act. Current
P2.17.13.2	CosPhiiRef	-1	1		0		0,001	3304	> 0 decreases voltage < 0 increases voltage
P2.17.13.3	Reserved	0,00	320	s	0,00		0,01	3556	

**6.17.10.1 Voltage Log In Log Out**

Code	Parameter	Min	Max	Unit	Default	Cust	Step	ID	Description
P2.17.13.4.1	Lock In Voltage	0	150	%	0		0,01	3305	
P2.17.13.4.2	Lock Out Voltage	0	150	%	0		0,01	3306	
P2.17.13.4.3	Max Cos Ref	-1	1		1,000		0,001	3346	

**6.17.10.2 Active Current**

Code	Parameter	Min	Max	Unit	Default	Cust	Step	ID	Description
P2.17.13.5.1	Min Cos Ref Min Power	-150	150	%	15,0		0,1	3357	
P2.17.13.5.2	Min Cos Ref	-1	1		1,000		0,001	3356	> 0 decreases voltage < 0 increases voltage
P2.17.13.5.3	CosRefMidPower	-150	150	%	50,0		0,1	3358	
P2.17.13.5.4	Max Cos Ref Max Power	-150	150	%	150,0		0,1	3359	
P2.17.13.5.5	Max Cos Ref	-1	1		1,000		0,001	3346	

**6.17.11 EXTERNAL INPUT**

Code	Parameter	Min	Max	Unit	Default	Cust	Step	ID	Description
P2.17.14.1	Ext GC Trip NO	0.1	E.10	DI	0.1		1	3310	
P2.17.14.2	Ext GC Trip NC	0.1	E.10	DI	0.2		1	3398	
P2.17.14.3	SeparateFLimMon	0.1	E.10	DI	0.1		1	3311	
P2.17.14.4	SepFreqHighLim	0	150	%	0		0,01	3312	
P2.17.14.5	SepFreqLowLim	0	150	%	0		0,01	3313	

**6.17.12 LIMITED GRID SUPPORT**

Code	Parameter	Min	Max	Unit	Default	Cust	Step	ID	Description
P2.17.15.1	EnableLimSup	0.1	E.10	DI	0.1		1	3446	
P2.17.15.2	LimitedSuppMode	0	1		0		1	3447	
P2.17.15.3	Voltage Level Low	0	150	%	0,00		0,01	3448	
P2.17.15.4	Voltage Level High	0	150	%	0,00		0,01	3542	



## 6.17.13 OPTIONS

Code	Parameter	Min	Max	Unit	Default	Cust	Step	ID	Description
P2.17.16.1	GC Options 1	0	65535		0		1	3328	
P2.17.16.2	Voltage Filt. TC	0	10000	ms	20		1	3332	
P2.17.16.3	Frequency Filt. TC	0	10000	ms	35		1	3333	
P2.17.16.4	FRT Options	0	65535		0		1	3400	
P2.17.16.5	Vac Stop Offset	-10,00	10,00	%	0,00		0,01	3337	
P2.17.16.6	Vac Run Offset	-10,00	10,00	%	0,00		0,01	3338	
P2.17.16.7	Power Follower Hysteresis	0,0	100,0	%	3,0		0,1	1529	
P2.17.16.8	Line Voltage High Filter TC	0	10000	ms	100		1	3373	
P2.17.16.9	LineFreqLow TC	0	100	ms	20		1	3375	
P2.17.16.10	FRT Trig Level	0,00	320,00	%	0,00		0,01	3382	
P2.17.16.11	Current x TC	0	1000	ms	16		1	3409	
P2.17.16.12	LV Feedback Kp	0	300	%	0,00		0,01	3420	
P2.17.16.13	Current Priority Sel	0	4		0		1	3422	0 = Normal 1 = Active Current 2 = Reactive Current 3 = CosPhiRef 4 = CosPhi&Reactive
P2.17.16.14	LineFreqHigh TC	0	3000	ms	120		1	3440	
P2.17.16.15	Reactive Voltage Compensation	0	1		0		1	3540	0 = Reactive Current Ref 1 = Reactive Power Ref
P2.17.16.16	EON Trig Level	0,0	800,0	%	0,0		0,01	3541	
P2.17.16.17	Priority Margin	0,0	10,0	%	5,0		0,1	4532	

**6.18 KEYPAD CONTROL (CONTROL PANEL: MENU M3)***Table 58. Keypad control parameters M3*

Code	Parameter	Default	Min	Max	Unit		ID	Description
P3.1	Control Place	2	0	2			1403	0 = PC Control 1 = I/O terminal 2 = Keypad (Default) 3 = Fieldbus 4 = SystemBus
P3.2	Licence Key	0	0				1995	
P3.3	SW Test LK	0	0	65535			4502	

**6.19 SYSTEM MENU (CONTROL PANEL: MENU M6)**

For the parameters and functions related to the general use of the AC drive, such as application and language selection, customised parameter sets or information about the hardware and software, see the Vacon NX User Manual.

**6.20 EXPANDER BOARDS (CONTROL PANEL: MENU M7)**

The M7 menu shows the expander and option boards attached to the control board, and the board-related information. For more information, see the Vacon NX User Manual and the Vacon I/O option board manual.

## 7. DESCRIPTION OF PARAMETERS

### 7.1 BASIC PARAMETERS

#### 2.1.1 Grid Nominal Voltage $V$ ID110

This parameter sets the incoming line voltage for the regenerative drive at the OPT-D7 connection point, drive terminal voltage is calculated internally.

Set this parameter to the nominal line voltage at the installation site. Used also as a reference point for Grid Code protection functions. Use G2.2.8 Voltage Correction for static voltage correction.

In Grid Converter Application Grid Nominal Voltage is not used as reference point for DC Voltage Reference, therefore set also System Rated DC correctly P2.1.7 ID1805. This is needed that AFE operation will work correctly and MCB is closed at correct voltage level. See chapter Transformer Parameters.

Depending on system, transformer and especially selected start synchronization, acceptable AC Voltage level may differ from normal when using Grid Code functions or operating as a single power source for the grid.

#### 2.1.2 Grid Nominal Frequency $Hz$ ID1532

Micro Grid and Island mode frequency set point. In Micro Grid mode used as a reference point for the Base Current reference and drooping. Use G2.11 FreqDroopOffset for static frequency adjustment.

In AFE mode used as a reference point for Grid Code protection functions.

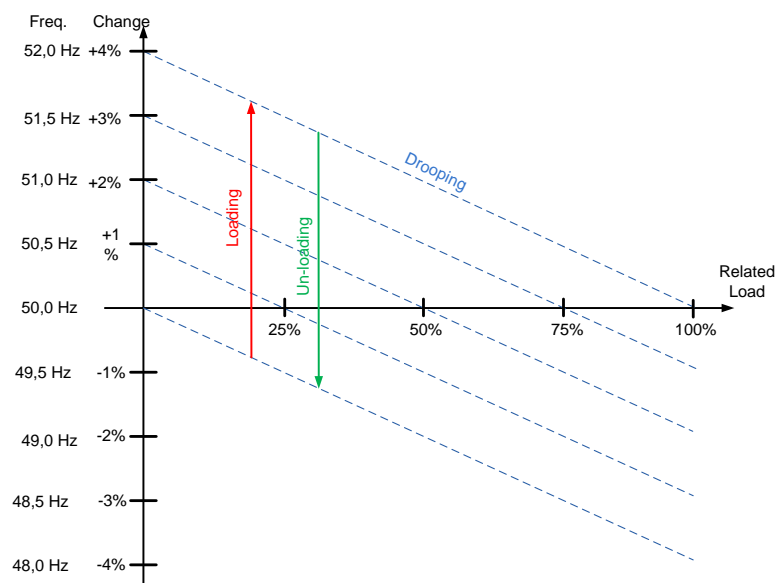

Figure 9.

#### 2.1.3 Grid Converter Rated Current $A$ ID113

Grid Converter rated current, recommended to keep default to have optimum control.

Grid Converter unit default values are fine tuned to it's matching LCL filter and default controls settings should not be changed unless using non-standard LCL filter.

The active current and the reactive current are scaled to this parameter as is the current cutter level.

See Default Currants in Chapter 1 for different units.

#### 2.1.4 *System Rated Cos Phi* ID120

Enter the system rated Cos Phi.

#### 2.1.5 *System Rated kVA* ID213

Enter the system rated kVA.

#### 2.1.6 *System Rated kW* kW ID116

Set the rated active power of the system.

#### 2.1.7 *System Nominal DC* ID1805

This value is used as a reference point for DC Voltage reference instead of Grid Nominal Voltage. Also defined closing limit for the MCB, 85% of the System Nominal DC Voltage.

#### 2.1.8 *Parallel AFE* ID1501

Set this to 1 if more than one unit is connected to same DC bus.

0 = Single AFE

1 = Parallel AFE

When you select parallel AFE, DC drooping is set to 3.00% and modulation is synchronised to reduce circulating current if the drives are in a common DC bus.

### 7.1.1.1 TRANSFORMER PARAMETERS

These parameters are used to scale voltage so that the parameter P2.1.1 Grid Nominal Voltage can be given a value as actual grid voltage. The drive will calculate the actual drive terminal voltage based on these values.

**NOTE:** When ratio is different than 1:1 also P2.1.7 System Nominal DC parameter must be given so that MCB is closed at correct voltage level and AFE mode DC Voltage reference will give correct DC-Link Voltage.

#### 2.1.9 Transformer GC Side Voltage ID1850

Set the transformer nominal voltage on Grid Converter side (U4).

#### 2.1.10 Transformer Grid Side Voltage ID1851

Set the transformer nominal voltage on Grid side (U5).

#### 2.1.11 Transformer Phase Shift ID1852

Set the transformer phase shift. Difference in angle, between U3 and U5. When OPT-D7 measurement is connected to U5 (i.e. to ship grid). This information is used if OPT-D7 assisted AFE start synchronization is activated. Usually Dyn11 transformer has 30.0 degree phase shift.

**NOTE:** Synchronization to external grid will use different set of parameters for phase shifts.

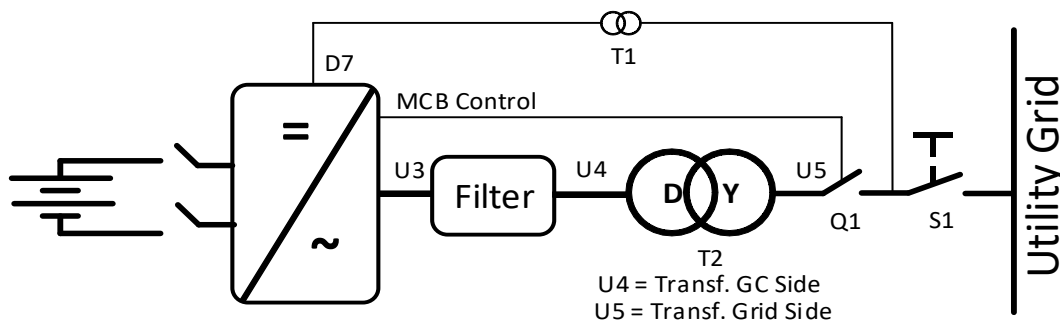

Figure 10.

#### P2.1.12 Identification ID631

Identification function will calibrate current measurement.

0 = No Action

1 = Current measurement offset

7.2 REFERENCE HANDLING

2.2.1 DC Voltage Reference ID1462

This parameter sets the DC Voltage reference in % of the Nominal DC voltage.

Final DC Voltage Ref (V1.1.2) = Nominal DC Voltage \* DC Voltage Reference

The DC Voltage will be maintained at this level when the regenerative unit is running.

There is internal limitation to reference: For 500V units the maximum limit is 797 Vdc and for 690V units the maximum limit 1099 Vdc.

The maximum limit can be monitored from V1.1.15 DC Ref Max Lim.

**NOTE!** When transformer ratio is different than 1:1 also P2.1.7 System Nominal DC parameter must be given so that MCB is closed at correct voltage level and AFE mode DC Voltage reference is giving correct DC-Link Voltage.

By default the internal DC voltage reference is kept the same as the actual DC voltage when the drive is in STOP state, or the operation mode is Island or Micro Grid. This is to make the change to the AFE mode smoother when the change is done on the fly.

When DC Voltage Reference is given from fieldbus and drive is in Fieldbus control, its recommended to use "FBSpeedReference" as DC Voltage Reference input, this will give fastest response.

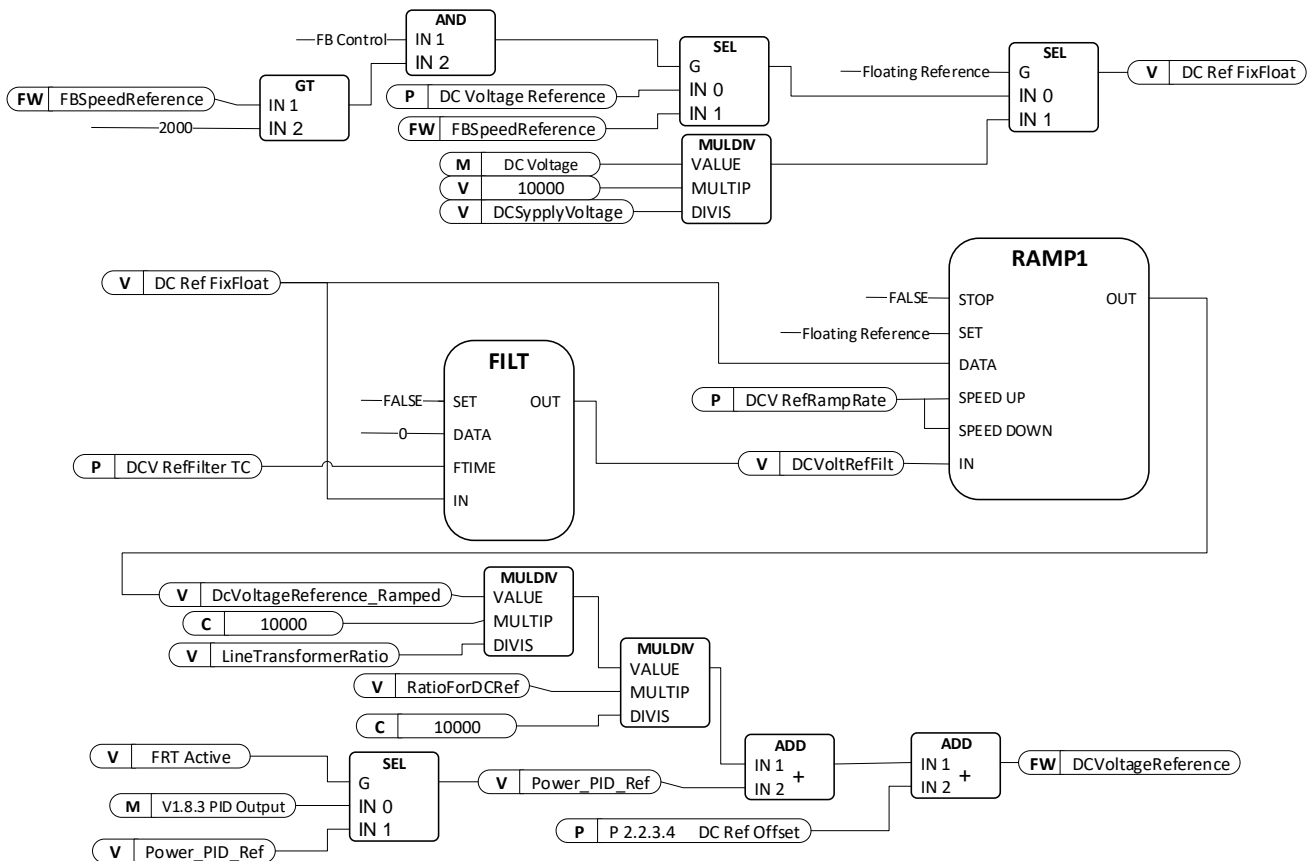

### 2.2.2 *Reactive Current Reference* ID1459

This parameter sets the reference for the reactive current in % of the nominal current.

This can be used for power factor correction of AFE system or reactive power compensation. Positive value gives inductive compensation whereas negative value gives capacitive compensation.

In uGrid mode 100.0 % reactive reference will decrease voltage by set voltage drooping value.

**NOTE:** Reactive Current reference does not affect voltage in island mode operation.

### 7.2.1 DC REFERENCE TUNING

#### 2.2.3.1 DC Drooping ID620

When AFEs are used in parallel in independent mode, drooping can be used for current balancing. The DCV voltage reference drooping is set as % of the active current reference.

For example, if drooping is 3.00% and active current is 50%, the DC voltage reference is reduced by 1.5%. With drooping, paralleled units can be balanced by adjusting the DCVoltReference to slightly different values.

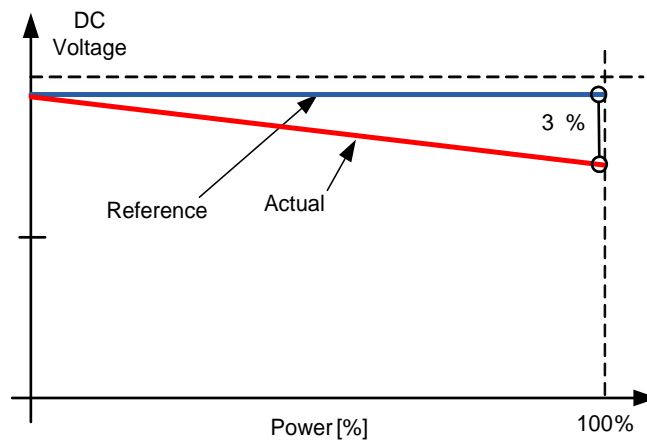

Figure 11.

#### 2.2.3.2 DC Voltage Ramp Rate ID1199

This parameter defines the ramp rate for the DC voltage reference change. The rate is defined as %/s. Firmware has separate fixed ramp rate 50 %/s.

By default the internal DC voltage reference is kept the same as the actual DC voltage when the drive is in STOP state, or the operation mode is Island or Micro Grid. This is to make the change to the AFE mode smoother when the change is done on the fly.

Setting ramp rate to negative value ramping is bypassed.

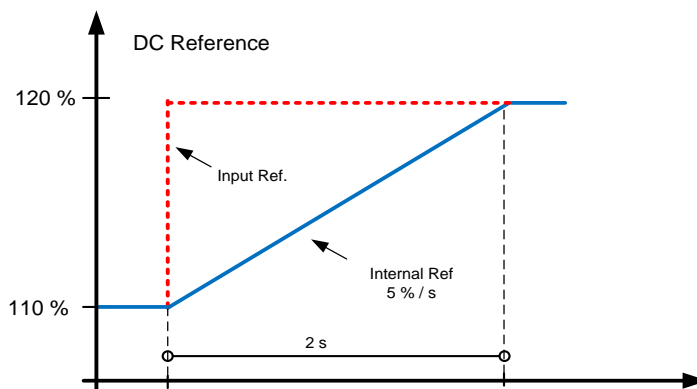

Figure 12.



**P2.2.3.3 DCV PI Power Follower rate [%/s] ID1678**

Defines ramp rate for DC Voltage reference from actual when DC Reference mode is 2 / PI Ref Floating. Ramp is used when PI Power controller in AFE mode is active. Function benefits are that upper system does not need to send actual dc voltage as reference to follower when power PI is active and enables to make optimal tuning form PI Controller maximum and minimum ranges.

**2.2.3.4 DC Reference Offset [%] ID1776**

Offset for DC Reference, used to balance parallel unit active current while using same DC Reference P2.2.1. in all units.

**P2.2.3.5 DC Reference Mode ID1718**

Defines how dc reference is handled in certain cases.

**-1 = Direct Iq Ref**

Base Current Reference is direct Iq Reference

**0 = Fixed**

DC Reference is fixed to set reference

**1 = Floating**

DC Reference is floating when stop state and when not operating in AFE mode, this enables smoother transition from actual dc link voltage to set reference.

**2 = PI Ref Floating**

This mode additionally to mode 1 will follow dc voltage actual when power PI Controller is active see also ID1678

**7.2.2 POWER /FREQUENCY REFERENCE****2.2.4.1 Frequency Drooping Offset**

This parameter is used to adjust the base frequency for load sharing purposes with drooping. For example, if drooping is set to 2 Hz this parameters can be set to 1 Hz so that when the load is 50%, the frequency will be at the nominal point. The offset can also be set by the supply frequency parameters. However, in that case the grid frequency protection function will also use this increased value as a reference point and makes the protection function activate at the wrong frequency.

When you use this parameter for drooping purposes, the supply frequency can be left to the nominal value.

Final frequency reference is also limited by G2.9.7 frequency warning limits.

**2.2.4.2 Frequency Down (DigIn) ID417**

Select a digital input to decrease the base frequency with a set ramp rate.

See also ID1700 FB Micro Grid CW1 Bit 4 Power Down

### 2.2.4.3 Frequency Up (DigIn) ID418

Select a digital input to increase the base frequency with a set ramp rate. Frequency change is also limited by G2.3 Ramp Time and Ramp Range.

See also ID1700 FB Micro Grid CW1 Bit 5 Power Up

### P2.2.4.4 Frequency Adjust Rate ID 331

Defines the rate that is used to change the frequency reference when Frequency Up (ID418) and Frequency Down (ID417) inputs are used.

### P2.2.4.5 Freq. Max Adjust ID 1558

Maximum adjustment that Frequency MotPot function (ID417 & ID418) can make to frequency reference.

### 2.2.4.6 Base Current Reference ID1533

Base Current reference 100 % correspond to P2.1.3 Grid Converter Rated Current ID113.

#### AFE Mode

Base Current reference can be used also in AFE mode. This will require that PI Power Controller is also activated. In this mode DC Voltage Reference is adjusted that Based Current Reference is reached.

#### uGrid mode

The Base Current Reference determines offset for frequency reference within Frequency Drooping. For example, if frequency drooping is set to 2.000 Hz and grid frequency is constant 50 Hz with very small or nonexistent changes (isochronous or strong grid), and if 100% of Base Current Reference is given, the drive will feed 100% power to the grid. The situation is the same with the frequency reference set to 52 Hz and with 2.000 Hz drooping.

Base current reference can be used together with selection 3 of P2.11.5

StartPowerMode: Isochron.Gen. This selection will keep the drive frequency reference same as the grid frequency, and the power that is fed or taken from the drive is solely defined by the Base Current Reference parameter.

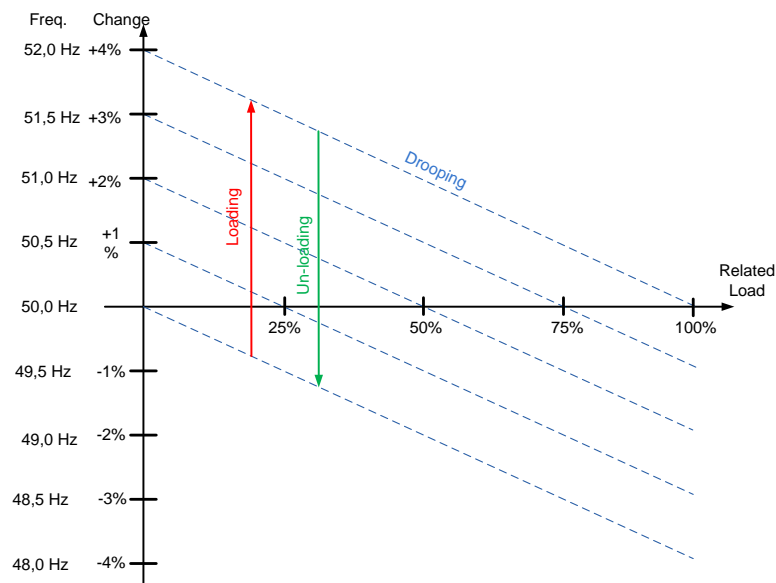

Figure 13.

**2.2.4.7 Base Reference Ramp Rate ID1536**

This parameter defines the increase rate of the base current reference when the reference is changed, or the drive is started. This is used in uGrid mode. AFE used Power PI Controller.

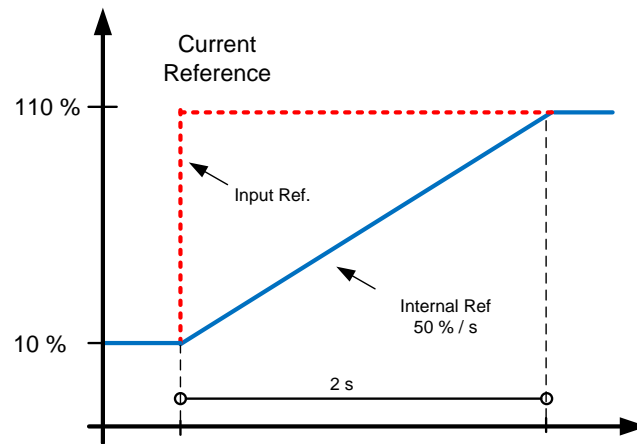

Figure 14.

**2.2.4.8 Base Reference to Zero ID1537**

This parameter defines in which situations Base Current Reference is set to the value of P2.2.6.8 BaseRefAtStop.

0 = No action.

1 = Reference set to P2.2.6.4 when at STOP state.

2 = Reference set to P2.2.6.4 when AFE mode is active.

3 = Reference set to P2.2.6.4 when AFE mode is active or drive in STOP state.

**2.2.4.9 Base Reference at Stop State ID1538**

Base reference on situation selected by P2.2.6.7 Base Reference to Zero. Reference is ramped after start command to P2.2.6.5. This parameter defines power level that is injected to grid right after synchronisation.

**NOTE!** The actual power will be determined by the set supply frequency, drooping and the start power mode.

**2.2.4.10 Frequency; MotPot Reset ID 367**

Select reset function for motor potentiometer function,

0 = No action.

1 = MotPot adjustment is reset at stop state.

2 = MotPot adjustemet is reset when AFE mode is active.

3 = MotPot adjustmern is reset when AFE mode or in stop state.

#### 2.2.4.11 *Reference Mode ID1914*

Select if Power PI Reference is direct Iq current reference or if the reference is voltage compensated between 80 %...135 % of Un.

0 = Pure Iq Reference

1 = Voltage Compensated (Power Ref)

7.2.2.1 PID Power Controller

This function is used to control drive power when operating in AFE mode. P2.2.4.6 Base Current Reference is used as reference input and V1.1.5 Active Current is used as actual value. PID Controller is forced to zero when DI: PID Power Activation is low or drive is in stop state or drive is not operating in AFE mode. PID Controller will adjust power flow by giving offset to given DC Voltage Reference. It's recommended to use some drooping to make controller smoother.

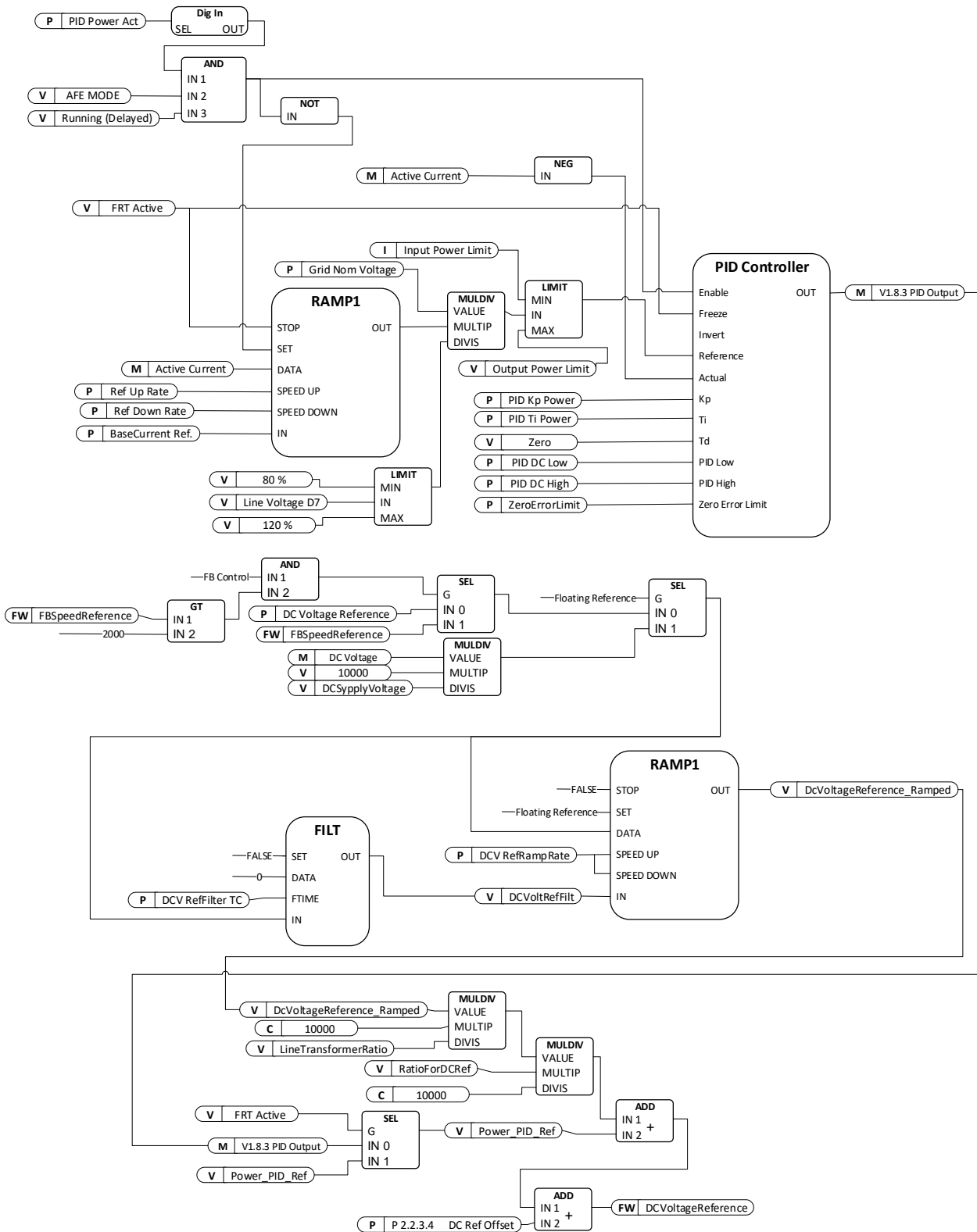

**2.2.4.12.1 PID Power Activation ID1905**

Select digital input to activate PID Power control function. This signal can be controlled from fieldbus with FB Control Word by assailing e.g. P2.5.1.20 to ID1905.

**2.2.4.12.2 PID Kp ID1911**

Gain for PID controller.

**2.2.4.12.3 PID Ti ID1906**

Integration time for PID controller.

**2.2.4.12.4 PID DC Low ID1903**

This parameter defined how low PID controller can adjust DC Voltage Reference from P2.2.1 DC Voltage Ref.

**2.2.4.12.5 PID DC High ID1904**

This parameter defined how high PID controller can adjust DC Voltage Reference from P2.2.1 DC Voltage Ref.

**2.2.4.12.6 Reference Down Rate %/s ID1810**

Power reference ramp rate when increasing the reference. Setting negative value will bypass reference ramping. Keeping small ramp rate is recommended to reduce PI controller overshoot if needed. See also ID4530.

**2.2.4.12.7 Reference Up Rate %/s ID1811**

Power reference ramp rate when decreasing the reference. Setting negative value will bypass reference ramping. Keeping small ramp rate is recommended to reduce PI controller overshoot if needed. See also ID4530.

### 2.2.4.12.8 PI Actual Limit Gap To Request Limit ID1842 "PIActLimGapToReq"

When power PI controller is operational this parameter defines the gap between requested power limit and the power limit that is used by the system software. When power PI controller is used the requested Power/Active Current limit is given as reference limitation to Power PI controller.

### 2.2.4.12.9 PI Ref Limit Gap To Request Limit ID1844 "PIRefLimGapToReq"

When PI controller is operational this parameter defines increase to Power Pi controller reference limitation from requested power limit.

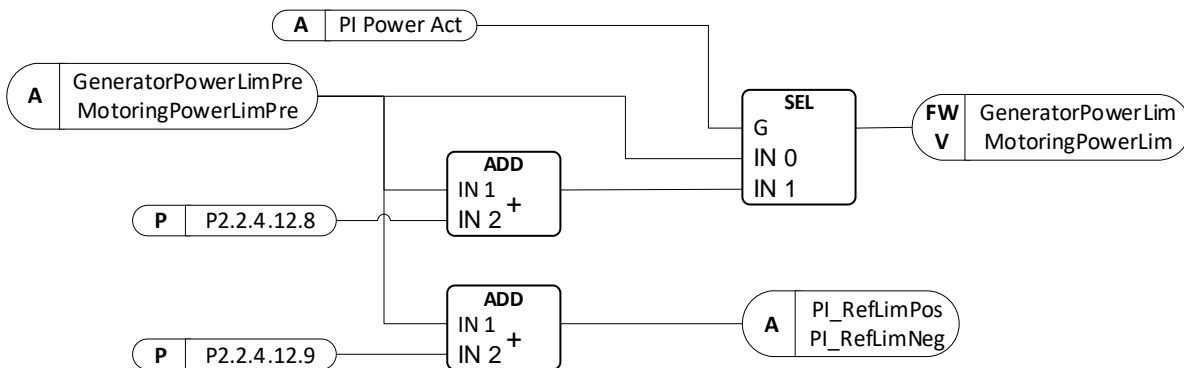

### 2.2.4.12.10 Zero Error Limit ID1843

When PI Error is below this value regulation is stopped with delay ( $5 \cdot T_i$ ).

### 2.2.4.12.11 PI Start Delay ID1845

This parameter defines delay after the Run state when PI-controller is started.

### P2.2.4.12.12 PID FRT $K_p$ ID1915

PID gain after FRT situation for 1 second to return power to previous level.

### P2.2.4.12.13 PID FRT $T_i$ ID1916

PID integration time after FRT situation for 1 second to return power to previous level.

*P2.2.4.12.14 RefRampFormat**ID4530*

PID Reference ramp format. Using reference ramp rate can reduce overshoots even in fast reference changes.

**1 = # F**

Ramp format is # %/s. And PI controller is operating at 1 ms time level.

**2 = #,# F**

Ramp format is #,# %/s. And PI controller is operating at 1 ms time level.

**3 = #,## S**

Ramp format is #,## %/s. And PI controller is operating at 10 ms time level.

Default ramp format

**4 = #,## F**

Ramp format is #,## %/s. And PI controller is operating at 1 ms time level.

**5 = #,# S**

Ramp format is #,# %/s. And PI controller is operating at 10 ms time level.

**6 = # S**

Ramp format is # %/s. And PI controller is operating at 10 ms time level.



7.2.2.2 High Frequency Power Reference AFE Operation

With this function drive can decrease power output to grid automatically without upper system control when there is a frequency increase in the grid. Base current reference is still operational compared to same function in Grid Code group where Base Current reference is frozen during the event.

Power Decrease Log Off Frequency = Zero

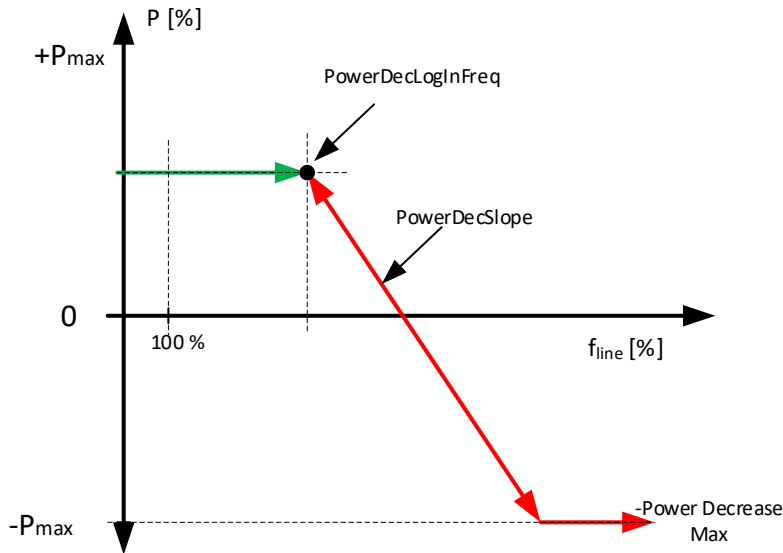

Power Decrease Log Off Frequency > Zero

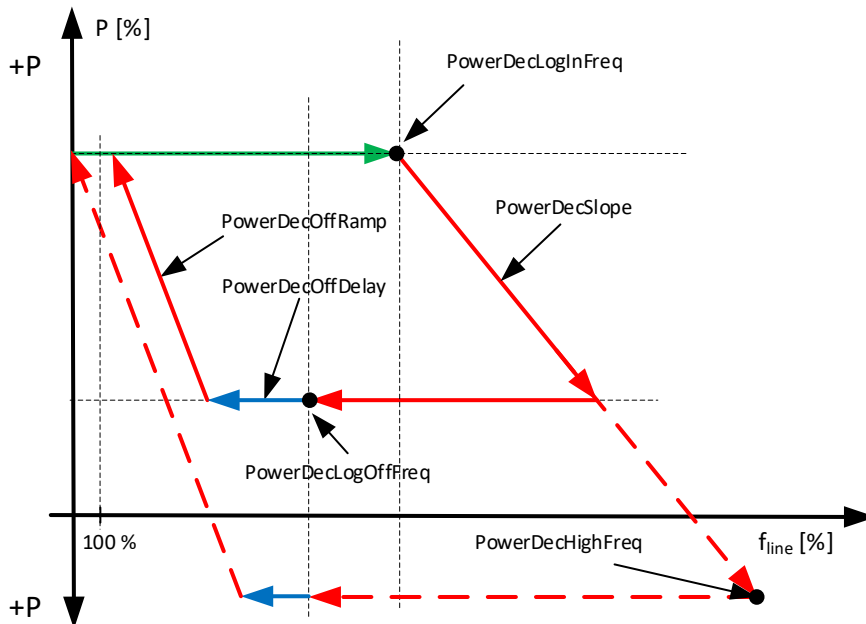

*P2.2.4.13.1 PowerDecLogInFreq ID4510*

Log in frequency when power is started to decrease.

*P2.2.4.13.2 PowDecLogOffFreq ID4511*

Log Off frequency when power is started to return to level before going above log in voltage.

*P2.2.4.13.3 PowerDecSlope [%/%] ID4512*

Slope how many percentages power is changed when frequency changes one percent.

*P2.2.4.13.4 PowerDecOffRamp ID4513*

Ramp rate that is used when power is released back to normal operation level.

*P2.2.4.13.5 PowerDecOffDelay ID4514*

Delay when power is released after frequency has fall below log off level.

*P2.2.4.13.6 PowerDec Max ID4515*

This parameter limit how much this function can decrease power from starting point.

*P2.2.4.13.7 PowerDecHighFreq ID4516*

When this parameter is defined greater than zero drive will calculate power slope internally to reach this frequency point with maximum input power reference.

7.2.2.3 Low Frequency Power Reference AFE operation

With this function drive can increase power output to grid automatically without upper system control when there is a frequency decrease in the grid. Base current reference is still operational compared to same function in Grid Code group where Base Current reference is frozen during the event.

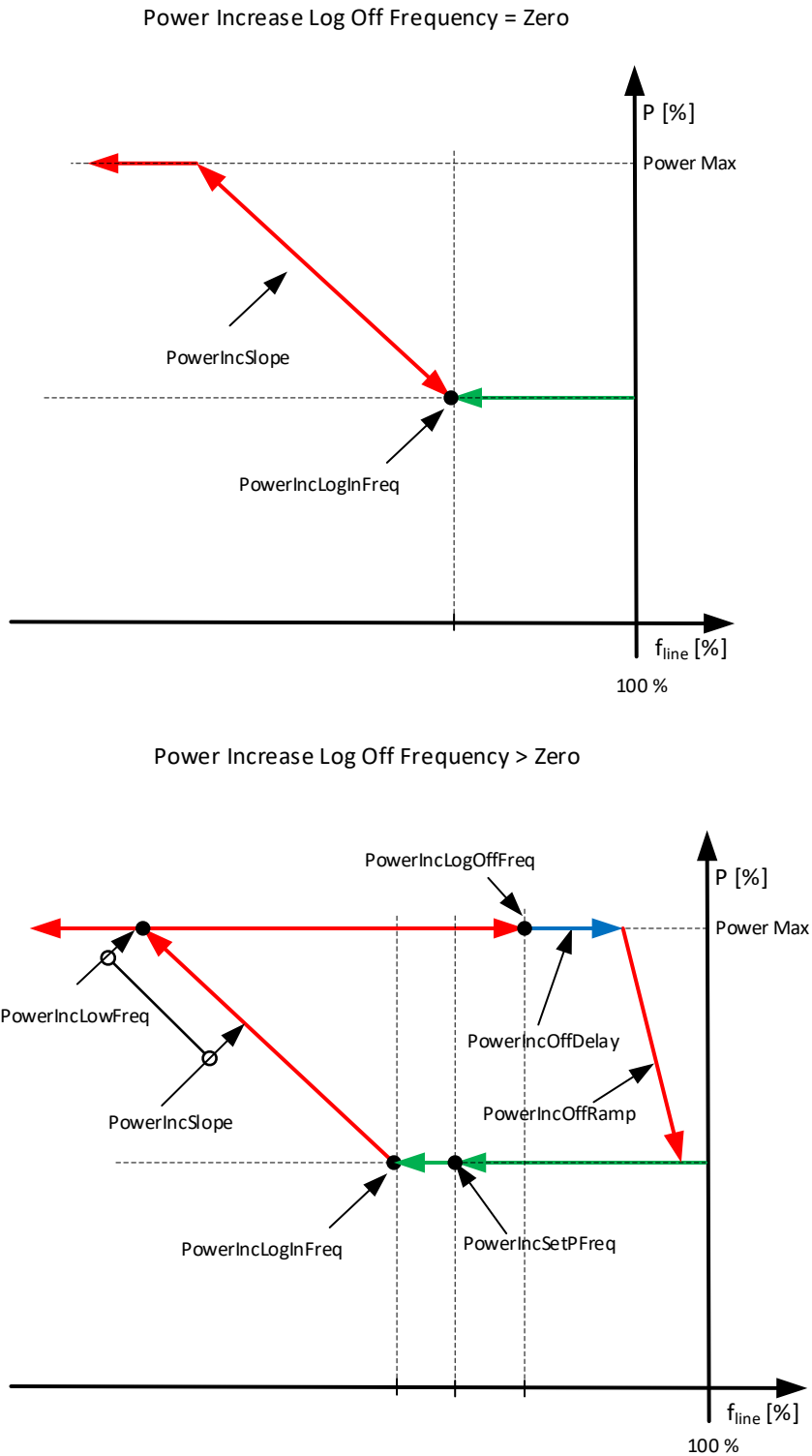

***P2.2.4.14.1 PowerIncLogInFreq [%] ID4517***

Power Increase High Frequency

Frequency when power is started to increase.

***P2.2.4.14.2 PowerIncLogOffFrequency ID4518***

Power Increase Log off frequency. Frequency level when function is disabled and delay and or ramp to normal power level is started, If set.

***P2.2.4.14.3 PowerIncSlope [%/%] ID4519***

Power Increase Slope

Slope how steeply power is increased calculated internally if ID4524 has been defined.

***P2.2.4.14.4 Power Increase Off Ramp ID4520***

Slope how many percent power is increased when frequency changes one percent. Calculated internally if ID4523 is greater than zero.

***P2.2.4.14.5 Power Increase Off Delay ID4521***

Delay after frequency has returned to normal level when power is started to ramp back to original level.

***P2.2.4.14.6 Power Increase Max ID4522***

This parameter limit how much this function an increase power from starting point.

***P2.2.4.14.7 Power Increase Low Frequency ID4523***

When this parameter is defined greater than zero drive will calculate power slope internally to reach this frequency point with maximum output power reference. If this is not defined ID4519 Power Increase Slope will define increase rate.

***P2.2.4.14.8 Power Increase Set Power Frequency ID4524***

This parameter defines the frequency point what actual power is used as start reference when frequency falls below Log In Frequency

**7.2.3 REACTIVE REFERENCE TUNING****2.2.5.1 Reactive Adjust Rate ID1557**

Defines the rate that is used to change the reactive current reference when Up and Down inputs are used.

**P2.2.5.2 Reactive Ref Up (DigIn) ID1553**

Select a digital input to increase the reactive reference with a set ramp rate.

**P2.2.5.3 Reactive Ref Down (DigIn) ID1554**

Select a digital input to increase the reactive reference with a set ramp rate.

**P2.2.5.4 Maximum Reactive Adjust ID1559**

Maximum reference change that Reactive MotPot function can make to main reference.

**P2.2.5.5 Reactive Mot Pot Reset ID1644**

Select when Reactive Reference MotPot is reset.

0 = No action.

1 = MotPot adjustment is reset at stop state.

**P2.2.5.6 Reactive Reference Filtering TC ID3554**

Defines filtering time constant for reactive current reference.

**7.2.4 AC VOLTAGE REFERENCE*****P2.2.6.1 Voltage at field weakening point ID603***

Above the field weakening point, the output voltage remains at the set value. Below the field weakening point, the output voltage depends on the setting of the U/f curve parameters.

***P2.2.6.2 Field weakening point ID602***

The field weakening point is the output frequency at which the output voltage reaches the field weakening point voltage. Set this to level where generator's AVR starts to decrease voltage as a function of generator speed.

***P2.2.6.3 Voltage Correction ID1790***

This parameter is used to compensate the zero load voltage drop in grid side when running in Micro Grid or island mode. The supply voltage parameter can also be used for this purpose, but Grid Voltage D7 protection uses this increased value for reference too. When using this parameter for compensation, the supply voltage can be left to nominal value.

**NOTE!** Some cases when inductor size and losses are compensated, the zero load voltage may need to decrease.

**P2.2.6.4 Capacitor Size [%] (ID1460)**

**AFE:** This parameter defines the reactive current going to the LCL filter capacitor. It compensates the LCL effect to the reactive current by adjusting the reactive current reference internally. The inductor size is also added to compensation. If set correctly, the power factor on the grid side will be 1.

**Island and Micro Grid:** Not used.

**P2.2.6.5 Inductor Size [%] (ID1461)**

**AFE:**

This parameter defines voltage losses in percentage of the nominal voltage at 100% active current. This value is internally added to the reactive current reference thus giving power factor 1 on the grid side, if set correctly together with Capacitor Size. The transformer and feeding cables can be compensated by increasing this value.

**Island and Micro Grid:**

This parameter defines the voltage increase in percentage of the nominal voltage at 100% reactive current.

- Supply Voltage: 400 Vac
- Inductor Size: 15.0 %
- Inductor losses: 15.0 %
- Reactive Current: 30.0 %
- Active Current: 50.0 %

$400 \text{ Vac} * 30,0 \% * 15,0 \% = 18 \text{ Vac}$ . Increase of voltage from reactive current.

Voltage drooping will decrease the final voltage if it is used.

**P2.2.6.6 Inductor Losses [%] (ID1465)**

**AFE:** Not used.

**Island and Micro Grid:** This parameter defined voltage increase in percentage from Inductor size at nominal voltage at 100% active current.

- Supply Voltage: 400 Vac
- Inductor Size: 15.0 %
- Inductor losses: 15.,0 %
- Reactive Current: 30.0%
- Active Current: 50.0 %

$400 \text{ Vac} * 50,0 \% * 15,0 \% * 15,0 \% = 4,5 \text{ Vac}$ . Increase of voltage from active current.

Voltage drooping will decrease the final voltage if it is used.

Together with inductor size and inductor losses voltage will be increased

$18 \text{ Vac} + 4,5 \text{ Vac} = 22,5 \text{ Vac}$  from Supply Voltage parameter -> 422,5 Vac.

**2.2.6.7 Voltage Down (DigIn) ID1551**

Select a digital input to decrease the supply voltage with a set ramp rate.

**2.2.6.8 Voltage Up (DigIn) ID1550**

Select a digital input to increase the supply voltage with a set ramp rate.

**2.2.6.9 Voltage Adjust Rate ID1555**

Defines the rate that is used to change the base voltage when Up and Down inputs are used.

**2.2.6.10 Voltage Maximum Adjust ID1639**

The maximum adjustment to the voltage when controlling reactive power.

**2.2.6.11 Voltage; MotPot Reset ID 1640**

Select reset function for motor potentiometer function,

0 = No action.

1 = MotPot adjustment is reset at stop state.

**2.2.6.12 Start Voltage Mode ID1641**

This parameter select how internal voltage reference is used in Micro Grid mode. Change that this function can do to Field Weakening Point voltage is limited by ID1880 and ID1881, Supply Voltage warning limits.

**0 = Start Zero Reactive Power OPT-D7**

The option board D7 is used to monitor the grid voltage and uses this as a starting point for reactive power drooping control.

**1 = Drooping**

The drive does not control the power to zero but goes directly to the drooping control with set parameters.

**2 = Keep Reactive Reference**

The drive will follow the line voltage exactly while reactive reference is zero, so the voltage change will not change the reactive power of the Grid Converter application. In this mode, reactive power is controlled by the reactive current reference assuming drive is not single power source for the grid.

**P2.2.6.13 Reset Zero Q Delay ID1642**

This parameter defines delay when Zero Reactive Power is reset, returning internal voltage compensation back to zero. Setting this value to zero will keep function active.



**P2.2.4.14 Zero Q Max Adjust** *ID1643*

Limit how much Zero Q control can adjust voltage to keep reactive power at zero, when limit is reached drive will control reactive based on set voltage drooping.

**P2.2.6.15 Capacitor Size 2nd** *ID3330*

Capacitor size can be adjusted based on voltage level. Set here the capacitor size at voltage level defined by ID3331

**P2.2.6.16 Capacitor Size 2nd Voltage** *ID3331*

Set here the voltage level where Capacitor Size 2nd is used ID3330. This voltage level needs to be defined as lower voltage than the set grid nominal voltage.

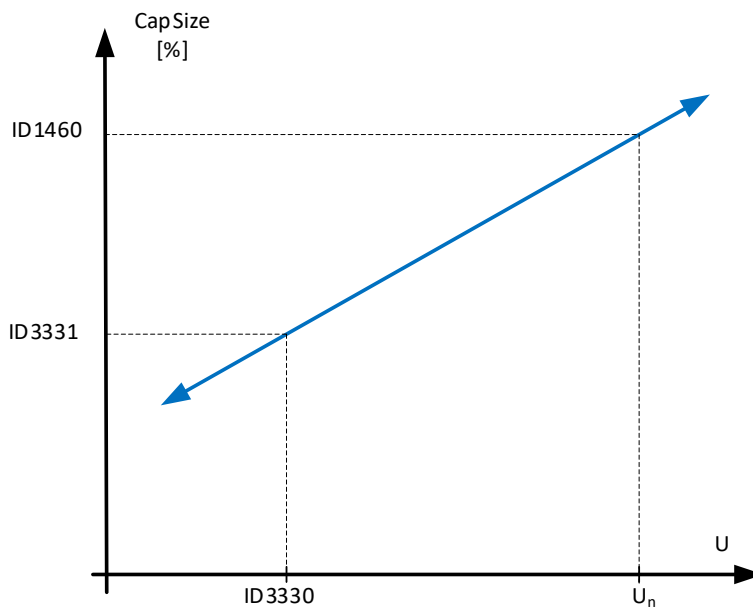
**P2.2.6.17 Keep Current Limit Max Adjust #,##** *ID1645 "KeepCurrLMaxAdj"*

This parameter defined maximum adjust to field weakening point voltage when controller tries to adjust voltage to keep total current below current limit in case Short Circuit current injection has not started. Function need a OPT-D7.

**P2.2.6.18 Cap Size Increase** *ID3550*

This parameter defines increase in Cap size when drive active current flow is from AC to DC direction and sign of reactive current in negative (V: ReactiveCurrent) or Cos Phii reference is negative.

**7.3 RAMP CONTROL**

*P2.3.1 Ramp Time ID103*

This parameter defines the time required for the frequency to increase and decrease between zero frequency and P2.3.2 Ramp Range.

*P2.3.2 Ramp Range ID232*

This parameter defines the frequency range where the ramp time is related. Starting from zero frequency.

**7.3.1 TRANSFORMER MAGNETIZATION**

Transformer magnetization function will enable starting without closing the MCB. Drive will start and make synchronization in uGrid mode or in Island mode to the grid and closed the breaker. Function is similar than synchronization to external grid but this function will control the MCB breaker.

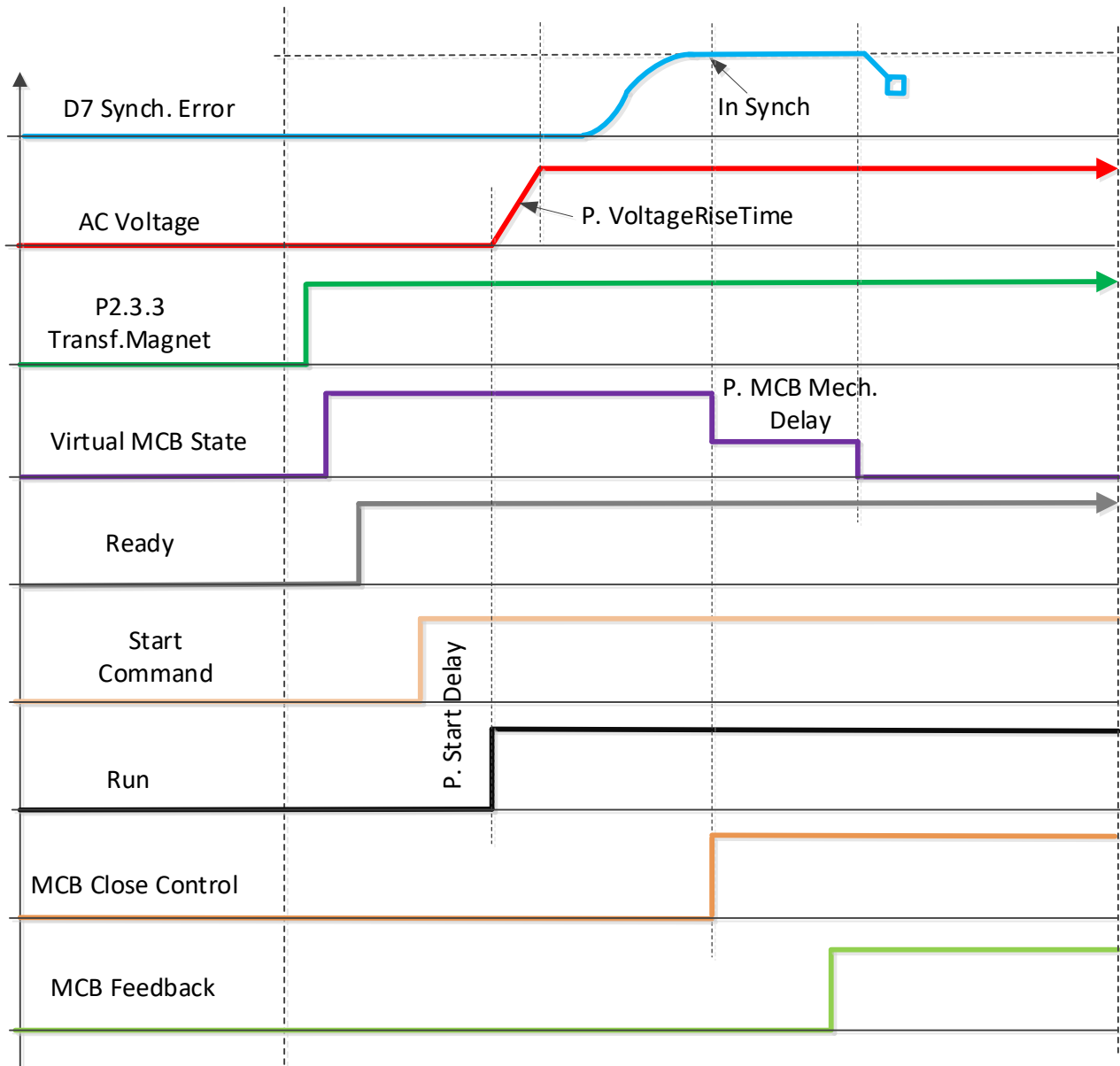

MCB breaker mechanical delay can be compensated with P2.5.7.7 MCB Mech. Delay ID1967

### *P2.3.3 Transf. Magnet ID1966*

Transformer magnetization function will enable starting without closing the MCB. Drive will start and make synchronization in uGrid mode to the grid and closed the MCB. Use e.g. P2.11.1 Control Mode 5 / uGrid-AFE. Drive will switch to AFE mode when MCB feedback is received.

#### **0 = No**

Not in use.

#### **1 = Yes**

Drive will make magnetization and synchronization automatically.

#### **2 = Commissioning**

In commissioning mode normal synchronization is done but drive will not close the MCB breaker.

NOTE: P2.5.7.3 MCB Close Mode needs to include option "Start" to drive automatically close MCB with transformer magnetization function.

## 7.4 INPUT SIGNALS

### 7.4.1 BASIC SETTINGS

#### P2.4.1.1 Start/Stop Logic Selection ID300 Start/Stop Logic

This parameter defines the start/stop logic when using I/O control.

#### 0 Start – No Act – Start Drive – No Action

Start 1: closed contact = start command DI “Start 1”

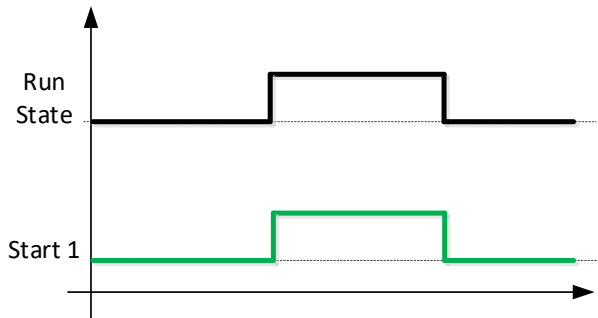

#### 1 StartP-StopP – Start Pulse – Stop Pulse

3-wire connection (pulse control):

DIN1: closed contact = start pulse

DIN2: open contact = stop pulse, falling edge.

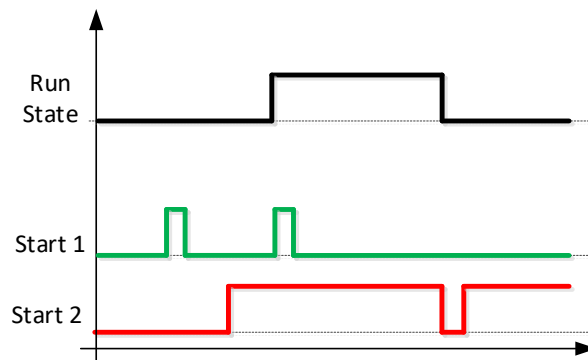

Figure 15. Start pulse/ Stop pulse.

The selections including the text *Rising edge required to start* is be used to exclude the possibility of an unintentional start when, for example, power is connected, re-connected after a power failure, after a fault reset, after the drive is stopped by Run Enable (Run Enable = False) or when the control place is changed. The Start/Stop contact must be opened before the motor can be started.

## 2 RPuls – RPuls – Rising pulse start – Rising pulse stop

Start 1: closed contact = Start command DI “Start 1”

Start 2: closed contact = Stop command DI “Start 1”

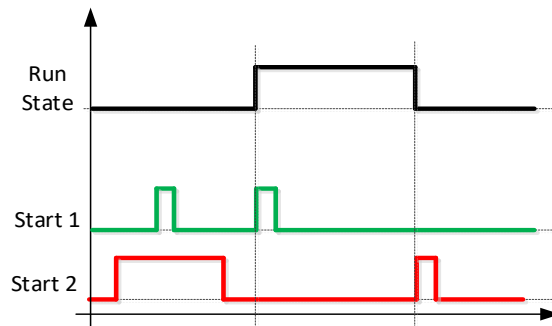

## 3 IO Toggle – Testing purposes

Drive will start and stop defined by ID4001 and ID4000 times when start command from IO is active.

### 2.4.1.2 Input Inversion ID1091

Bit selection to invert input signal logic.

B00 = +1 = INV Open Contactor

B01 = +2 = INV Ext. Fault 1

B02 = +4 = INV Ext. Fault 2

B03 = +8 = INV MCB Close Enable

B04 = +16 = INV DC Ground Fault

B05 = +32 = INV Klixon input 1

B06 = +64 = INV Klixon input 2

B07 = +128 = INV High Ambient temperature

B08 = +256 = INV Input Switch

### P2.4.1.3 IOStopDelToggle ID4001

### P2.4.1.4 IOStartDelToggleID4000

These are to be used to make repeated start and stops for testing purposes. Defining delays how long drive receives start and stop command when operating in IO control mode and start command has been given with Start Stop Logic (ID300) selection 3.

## 7.4.2 DIGITAL INPUT SIGNALS

### 2.4.2.1 *Start Signal 1 ID403*

Signal selection 1 for the start/stop logic. This parameter is used to select the input for Run Request signal

### 2.4.2.2 *Start Signal 2 ID404*

Signal selection 1 for the start/stop logic. This parameter is used to select the input for Stop Request signal.

### 2.4.2.3 *Open MCB ID1600*

This parameter is used to select the input for the Open Contactor signal. The signal is used to force the main circuit breaker open (MCB or MCB2) and to stop the modulating.

When this input is used to stop AFE and open a main circuit breaker, the DC link must be discharged and recharged to close the main circuit breaker again and to continue modulation.

If the Force Main circuit breaker Open signal is not used the option *0.1* = FALSE must be selected.

When the control is on the keypad, pressing the Stop button more than a 2 second opens the MCB.

### 2.4.2.4 *MCB Feed Back ID1453*

This parameter defines which digital input is used to the monitor circuit breaker status. The drive monitors the status and does not start if the state of the contactor does not correspond to the required status, that is, is open when it should be closed.

**NOTE!** Missing feedback signal prevent drive going to ready state. MCB Feedback can be monitored from Status Word B10.

**NOTE!** If feedback is not used there will be three second forced delay on internally generated MCB feedback signal. MCB Feedback can be monitored from Status Word B10.

### 2.4.2.5 *Fault Reset ID414*

Contact closed: all faults are reset. Rising edge.

### 2.4.2.6 *Ext Fault 1 ID405*

Contact closed: the fault is displayed and the motor stopped. Fault 51. Can be inverted by the input inversion control.

### 2.4.2.7 *Ext Fault 2 ID406*

Contact open: the fault is displayed and the motor stopped. Fault 51. Can be inverted by the input inversion control.

### 2.4.2.8 *Run Enable ID407*

When the signal is low, the drive will lose READY status.

Contact open: the start of drive disabled.

Contact closed: the start of drive enabled.

### 7.4.2.1 Synchronization to external grid

Synchronization logic is activated when digital output P2.5.1.11 NET CB Cont. is > 0.10. In this function OPT-D7 needs to be connected to external grid side and cannot be used for voltage compensation. When there are parallel unit's synchronization needs to be done by upper system. e.g. by controlling Frequency Up and Down commands to all units (and other power sources in the same grid).

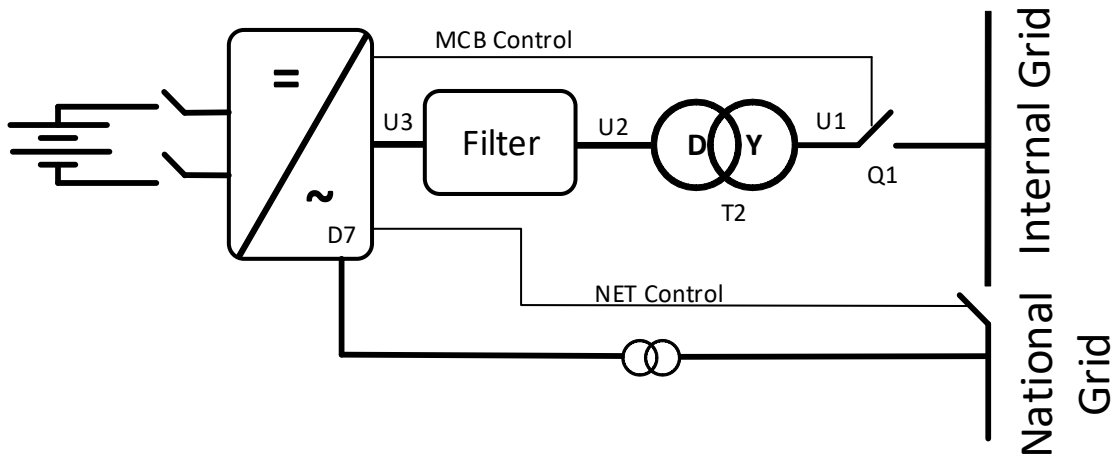

Figure 16.

### 2.4.2.9 NET Synchronisation ID1602

This input is used to the synchronisation of the external network when the drive is already generating network but in a different phase. It can be used only when OPT-D7 board is installed and measurements are on the external network side.

When the input is activated, the drive uses line frequency as a frequency reference and adjusts the voltage angle to correspond with the line voltage angle with given hysteresis.

When there are parallel unit's synchronization needs to be done by upper system. e.g. by controlling Frequency Up and Down commands to all units (and other power sources in the same grid).

### 2.4.2.10 NET Close Enabled ID 1705

An interlock for the NET contactor (shore). Used as information from Shore side if NET close is allowed.

If the interlock is not used in the system, the option 0.2= TRUE must be selected.

### 2.4.2.11 NET Close Request ID 1604

A command to close NET (shore) contactor. The closing will take place only when the drive is synchronised to the grid (shore).

This function is needed when the drive is already making a grid and needs to be synchronised to another grid that cannot be synchronised to the grid that the drive is making.

**2.4.2.12 NET Contactor Feedback ID 1660**

This parameter determines if the drive monitors the status of the NET contactor (shore) of the unit. The drive will switch from Island mode to Micro Grid mode if the control mode 4 / Island – Micro Grid is used. and from, Island to AFE mode when control mode 3 / Island – AFE mode is used.

If the status of the NET contactor is not monitored in the system, the option 0.1 = FALSE must be selected.

**2.4.2.13 Forced AFE Mode ID 1540**

Forces the drive control mode to 0 = AFE mode.

**2.4.2.14 Cooling Monitor ID750**

OK input from the cooling unit.

If the status is not monitored in the system, the option 0.2 = TRUE must be selected.

**2.4.2.15 Use MCB 2 Control ID1708**

This parameter is useful if 2 different supply networks are used. With this input, it is possible to select which one is used.

When the input is HIGH, MCB 1 is opened immediately.

**2.4.2.16 MCB 2 Feedback ID1710**

This parameter determines if the drive monitors the status of the main circuit breaker (MCB 2) of the unit. If the monitoring function is used, the unit monitors the status and will not start if the state of the contactor does not correspond to the required status, that is, is open when it should be closed.

If the status of the main circuit breaker 2 is not monitored in the system, the option 0.1 = FALSE must be selected.

**2.4.2.17 AFE Mode 2 ID1711**

Forces mode to P2.11.8 (MODE2). Only active when P2.1.1 is in 6/Free select.

**2.4.2.18 AFE Mode 3 ID1712**

When both 2.4.2.17 and 2.4.2.17 are true then P2.11.9 (Mode3) is selected. When 2.4.2.17 LOW and 2.4.2.17 HIGH, the AFE mode 1 selected. Only active when P2.11.1 is in 6/Free select.

**2.4.2.19 Quick Stop ID1213**

The drive stops the modulation immediately and opens the main circuit breaker.

**2.4.2.20 LCL Temperature ID1179**

The digital input from the LCL temperature monitoring.



### 2.4.2.21 RR Enable

Enables the final run request command. Used for testing purposes when precharge control is started directly from the start command and when you do not want the system to go the RUN state.

### 7.4.2.2 Forced control place

The digital inputs can be used to bypass parameter P3.1 Control Place, for example, in an emergency situation when PLC is not able to send command to the drive.

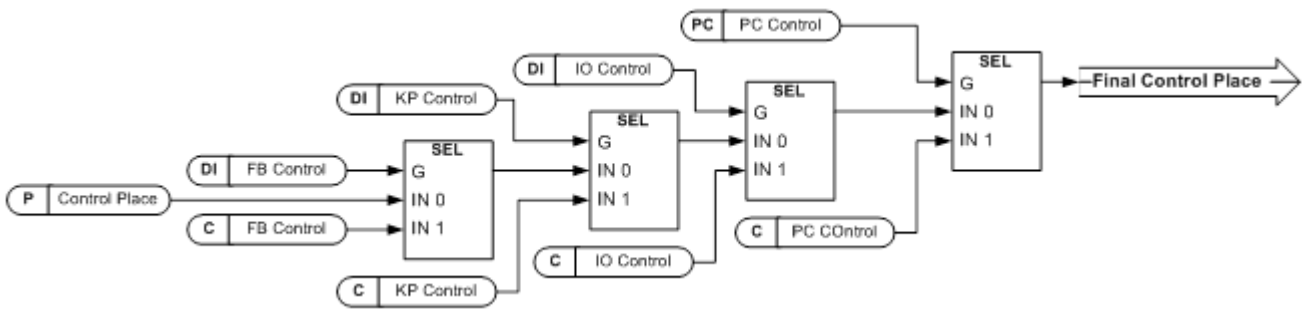

Figure 17. Control place selection priority order

### P2.4.2.22 Control from I/O terminal ID409 "I/O Term Control"

Contact closed: force the control place to I/O terminal.

### P2.4.2.23 Control from Keypad ID410 "Keypad Control"

Contact closed: force the control place to keypad.

### P2.4.2.24 Control from Fieldbus ID411 "Keypad Control"

Contact closed: force the control place to fieldbus.

**NOTE!** When the control place is forced to change, the values of Start/Stop, Direction and Reference that are valid in the control place in question are used. The value of parameter ID125 (Keypad Control Place) does not change. When the input opens, the control place is selected according to keypad control parameter P3.1 Control Place.

### P2.4.2.25 Enable CB Close ID1619 "Enable CB Close"

This input enables CB closing when the DC voltage is at a required level. It can be used on a battery system where drive DC is charged but it is not necessary for CB to close at this point. When the input goes high and DC is at required level, CB will close immediately.

**P2.4.2.26** *Reset P/Hz MotPot Adjust*      **ID 1608**      *“Reset P/Hz MPot”*

This input will reset adjustment made with Motor Potentio meter function to Power/Hz reference.

**P2.4.2.27** *DC Ground Fault*      **ID441**

Digital input to give DC Ground fault indication to the drive.

**P2.4.2.28** *Klixon In 1*      **ID780**

Klixon type temperature monitoring input 1. Low signal will generate warning W66 Klixon.

**P2.4.2.29** *Klixon In 2*      **ID781**

Klixon type temperature monitoring input 2. Low signal will generate fault F66 Klixon.

**P2.4.2.30** *Input Switch*      **ID1209**

Selects the digital input for the status of input switch. The input switch is normally switch fuse unit or main contactor with which the power is fed to the drive. If the input switch feedback is missing, the drive trips on “F55 Input Switch” fault.

**P2.4.2.31** *Ambient Temp*      **ID783**

Ambient temperature monitoring input Low signal will generate warning W88 Ambien Temp.

### 7.4.3 ANALOGUE INPUTS 1-4

2.4.3.1 AI1 signal selection ID377 "AI1 Signal Sel"

2.4.4.1 AI2 signal selection ID388 "AI2 Signal Sel"

2.4.5.1 AI3 signal selection ID141 "AI3 Signal Sel"

2.4.6.1 AI4 signal selection ID152 "AI4 Signal Sel"

Connect the AI3/AI4 signal to the analogue input of your choice with this parameter.

When the analogue input selection parameter is set to 0, you can control the analogue input monitoring variable from fieldbus by assigning a process data input ID number to the monitoring signal. This allows the scaling function on the drive side to PLC input signals.

2.4.3.2 Analogue input 1 signal filtering time ID324 "AI1 Filter Time"

2.4.4.2 Analogue input 2 signal filtering time ID329 "AI2 Filter Time"

2.4.5.2 Analogue input 3 signal filtering time ID142 "AI3 Filter Time"

2.4.6.2 Analogue input 4 signal filtering time ID153 "AI3 Filter Time"

First order filtering is used for the analogue input signals 3 and 4.

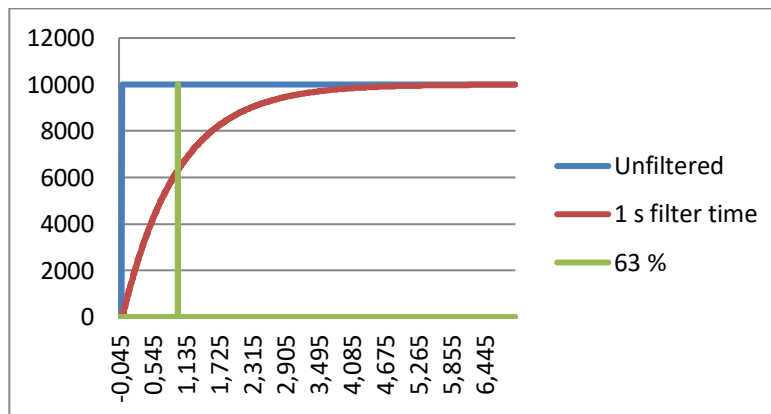

Figure 18.

2.4.3.3 AI1 custom setting minimum ID321 "AI1 Custom Min"

2.4.3.4 AI1 custom setting maximum ID322 "AI1 Custom Max"

2.4.4.3 AI2 custom setting minimum ID326 "AI2 Custom Min"

2.4.4.4 AI2 custom setting maximum ID327 "AI2 Custom Max"

2.4.5.3 AI3 custom setting minimum ID144 "AI3 Custom Min"

2.4.5.4 AI3 custom setting maximum ID145 "AI3 Custom Max"

2.4.6.3 AI4 custom setting minimum ID155 "AI4 Custom Min"

2.4.6.4 AI4 custom setting maximum ID156 "AI4 Custom Max"

Set the custom minimum and maximum input level for the AI3 signal within -160...160%.

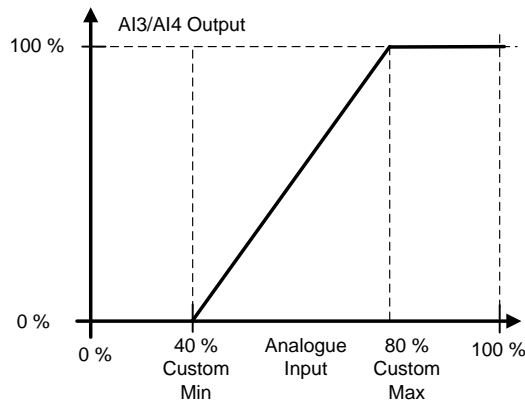

Figure 19.

2.4.3.5 AI1 signal inversion ID387 "AI1 Signal Inv"

2.4.4.5 AI2 signal inversion ID398 "AI2 Signal Inv"

2.4.5.5 AI3 signal inversion ID151 "AI3 Signal Inv"

2.4.6.5 AI4 signal inversion ID162 "AI3 Signal Inv"

The signal inversion function is useful for example in a situation where PLC sends power limit to the drive by using analogue inputs. If PLC is unable to communicate to the drive, the power limit is normally zero. When an inverted signal logic is used, a zero value from PLC means maximum power limit. This allows you to run the drive, for example, from the keypad without changing the power limit parameters.

0 = No inversion

1 = Signal inverted

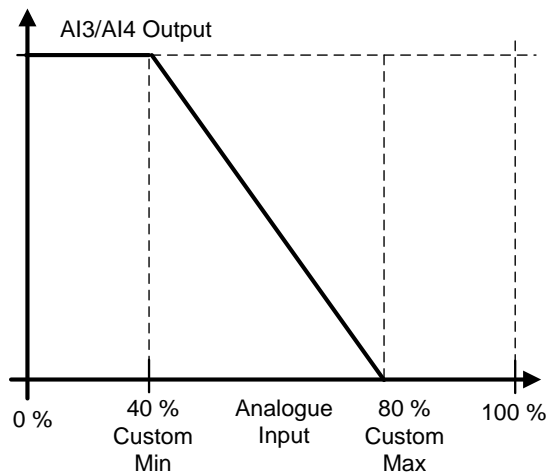

Figure 20.

### 7.4.3.1 Analogue input to any parameter

This function allows you to control any parameter by using an analogue input. Use a parameter to select the range of the control area and the ID number for the parameter that is controlled.

2.4.3.6	<i>Analogue input 1, minimum value</i>	ID303 "AI1 Scale Min"
2.4.3.7	<i>Analogue input 1, maximum value</i>	ID304 "AI1 Scale Max"
2.4.4.6	<i>Analogue input 2, minimum value</i>	ID393 "AI2 Scale Min"
2.4.4.7	<i>Analogue input 2, maximum value</i>	ID394 "AI2 Scale Max"
2.4.5.6	<i>Analogue input 3, minimum value</i>	ID1037 "AI3 Scale Min"
2.4.5.7	<i>Analogue input 3, maximum value</i>	ID1038 "AI3 Scale Max"
2.4.6.6	<i>Analogue input 4, minimum value</i>	ID1039 "AI4 Scale Min"
2.4.6.7	<i>Analogue input 4, maximum value</i>	ID1040 "AI4 Scale Max"

These parameters define the range for the controlled parameter. All the values are considered to be integers, so when you are controlling FWP as in the example, you also need to set numbers for the decimals. For example, FWP 100.00 must be set as 10000.

2.4.3.8	<i>AI1 Controlled ID</i>	ID1507	"AI1 Control. ID"
2.4.4.8	<i>AI2 Controlled ID</i>	ID1511	"AI2 Control. ID"
2.4.5.8	<i>AI3 Controlled ID</i>	ID1509	"AI3 Control. ID"
2.4.6.8	<i>AI4 Controlled ID</i>	ID1510	"AI4 Control. ID"

These parameters define which parameter is controlled.

#### Example:

You want to control Motor Field Weakening Point Voltage by an analogue input from 70.00% to 130.00%.

Set Scale min to 7000 = 70.00%.

Set Scale max to 13000 = 130.00%.

Set Controlled ID to 603 Voltage at field weakening point.

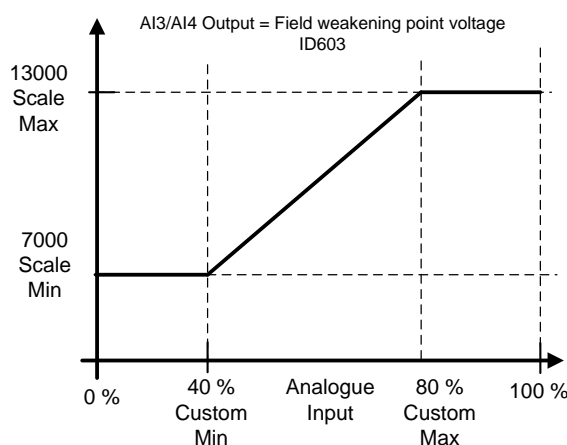

Figure 21.

The analogue input 3 signal 0 V to 10 V (0 mA to 20 mA) will control the field weakening point voltage between 70.00% and 130.00%. When setting a value, decimals are handled as integers.

## 7.5 OUTPUT SIGNALS

### 7.5.1 DIGITAL OUTPUT SIGNALS

#### 2.5.1.1 *Main Circuit Breaker 1 Close Control ID1218 "MCB1 Close Cont"*

AFE contactor, fixed to the relay output B.2.

When P2.5.1.2 is not activated, this output will stay high as long as MCB must be closed.

When the signal goes low, MCB must be open.

When P2.5.1.2 is activated, this gives only a closing command with a 2 s pulse.

#### 2.5.1.2 *Main Circuit Breaker 1 Open Control ID1219 "MCB1 Open Cont"*

When this output is selected above 0.9, the drive will use pulse control for the MCB breaker. P2.5.1.1 is used to close the breaker with a 2 s pulse.

The opening command is given by P2.5.1.2 with a 2 s pulse.

#### 2.5.1.3 *Ready ID432*

The AC drive is ready to operate.

#### 2.5.1.4 *Run ID433*

The AC drive operates (the drive is modulating).

#### 2.5.1.5 *Common Fault ID434*

A fault trip has occurred.

#### 2.5.1.6 *Fault, Inverted*

No fault trip has occurred.

#### 2.5.1.7 *At Reference*

The output frequency has reached the set reference. In AFE mode, when DC voltage level is on setpoint.

#### 2.5.1.8 *Overtemperature Warning*

The heatsink temperature exceeds unit temperature warning limit.

#### 2.5.1.9 *Warning*

A general warning signal. The warning will go low when the reset command is given.

#### 2.5.1.10 *Circuit Breaker 2 Close Control ID1709 "CB2 Close Cont"*

A second AFE contactor control. The drive can connect to two different networks. This will control the main circuit breaker of the second network.

#### 2.5.1.11 *NET Contactor Control*

The NET contactor control. Contactor control for Grid where the drive will be synchronised. This grid is usually the shore supply. When P2.4.2.12 NET Contactor feedback is received, the drive will change the operation mode to AFE mode.

#### 2.5.1.12 *D7 Synchronized*

The drive is synchronised to the D7 card. Information is sent, for example, to PLC that the drive is synchronised to an external network (where D7 is connected). This output cannot be used to control the NET contactor. There is a separate output signal for that purpose.

**2.5.1.13 Charge control**

When this is activated, the drive will start charging of DC from the start command and go directly to RUN state. The charging starts from the start command.

**2.5.1.14 Common alarm**

Drive has a warning active. This indication needs to be reset separately even if the situation is over.

**2.5.1.15 Ready For Start**

The drive has no interlock for starting the charging and going to RUN state.

**2.5.1.16 Quick Stop Active**

The drive has received a quick stop command.

**7.5.1.1 Fieldbus digital inputs connection**

**P2.5.1.17 Fieldbus input data 1 ID455 "FB Dig Input 1"**

**P2.5.1.19 Fieldbus input data 2 ID456 "FB Dig Input 2"**

**P2.5.1.21 Fieldbus input data 3 ID457 "FB Dig Input 3"**

**P2.5.1.23 Fieldbus input data 4 ID169 "FB Dig Input 4"**

The data from the fieldbus main control word can be led to the digital outputs of the drive. See the fieldbus board manual for the location of these bits.

**P2.5.1.18 Fieldbus digital input 1 parameter ID891 "FB Dig 1 Par ID"**

**P2.5.1.20 Fieldbus digital input 2 parameter ID892 "FB Dig 2 Par ID"**

**P2.5.1.22 Fieldbus digital input 3 parameter ID893 "FB Dig 3 Par ID"**

**P2.5.1.24 Fieldbus digital input 4 parameter ID894 "FB Dig 4 Par ID"**

With these parameters you can define the parameter to be controlled by using FB digital input.

**Example:**

All option board inputs are already in use, but you want to give a DI: DC Brake Command (ID416). You also have a fieldbus board in the drive.

Set parameter ID891 (Fieldbus Digital Input 1) to 416. Now you are able to control DC braking command from the fieldbus by Profibus control word (bit 11).

It is possible to control any parameter in the same way if values 0 = FALSE and 1 = TRUE are significant for that parameter. For example, P2.6.5.3 Brake Chopper (ID504) can be switched on and off using this function (Brake Chopper: 0 = Not Used, 1 = On, Run).

## 7.5.2 DELAYED DIGITAL OUTPUT 1 & 2

### 2.5.2.1 Dig.Out 1 Signal

### 2.5.3.1 Dig.Out 2 Signal

Connect the delayed DO1 signal to the digital output of your choice with this parameter.

### 2.5.2.2 DO1 Content

### 2.5.3.2 DO2 Content

- 0 = Not used
- 1 = Ready
- 2 = Run
- 3 = Fault
- 4 = Fault inverted
- 5 = FC overheat warning
- 6 = Ext. fault or warning
- 7 = Ref. fault or warning
- 8 = Warning
- 9 = Reverse
- 10 = SynchronisedToD7
- 11 = Start Command given
- 12 = FB DIN2
- 13 = FB DIN3
- 14 = ID.Bit DO, See P2.4.x.5
- 15 = Warning SR

### 2.5.2.3 DO1 ON Delay

### 2.5.3.3 DO2 ON Delay

### 2.5.2.4 DO1 OFF Delay

### 2.5.3.4 DO2 OFF Delay

With these parameters you can set the on and off delays to digital outputs.

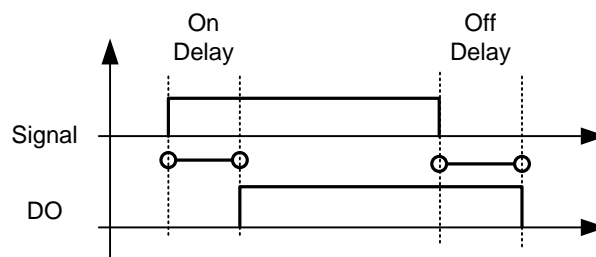

Figure 22. Digital outputs 1 and 2, on- and off-delays



**2.5.2.5** *ID.Bit Free DO***2.5.3.5** *ID.Bit Free DO*

Select the signal for controlling the DO. The parameter must be set in the format xxxx.yy where xxxx is the ID number of a signal and yy is the bit number. For example, the value for DO control is *1174.02*. 1174 is the ID number of Warning Word 1. So the digital output is ON when the bit number 02 of the warning word (ID no. 1174), that is, *Motor underload* is high.

**7.5.3** **ANALOGUE OUTPUT 1 & 2 & 3****2.5.4.1** *lout 1 signal***2.5.5.1** *lout 2 signal***2.5.6.1** *lout 3 signal*

Connect the AO signal to the analogue output of your choice with this parameter.

**2.5.4.2** *lout 1 Content***2.5.5.2** *lout 2 Content***2.5.6.2** *lout 3 Content*

0 = Not used

1 = DC-Link Voltage

Scaling: 500 Vac Unit 0-1000 Vac, 690 Vac Unit 0-1317 Vdc

2 = Total Current

Scaled to Grid Converter Rated Current. 0-100 %

3 = Supply Voltage

Scaled to Grid Nominal Voltage 0-100 %

4 = Active Current

Absolute value, scaled to 0-100 %.

5 = Power

Absolute value, scaled to 0-100 %

6 = Active Current, bidirectional.

Bidirectional signal. Scaled to -200 % to +200 %

7 = Power, bidirectional.

Bidirectional signal. Scaled to -200 % to +200 %

8 = AI1

9 = AI2

10 = FB Analogue Output

11 = Line Voltage

Scaled to Grid Nominal Voltage 0-100 %

12 = Supply Frequency Error, bidirectional

Supply Frequency error compared to set Grid Nom Frequency.

Scaling -5,00 Hz to +5,00 Hz

13 = Control Value output

14 = Reactive Current, bidirectional.

Bidirectional signal. Scaled to -200 % to +200 %

2.5.4.3 *lout 1 Filter Time*2.5.5.3 *lout 2 Filter Time*2.5.6.3 *lout 3 Filter Time*

Defines the filtering time of the analogue output signal. Setting this parameter value 0 will deactivate the filtering. First order filtering is used for the analogue output signals.

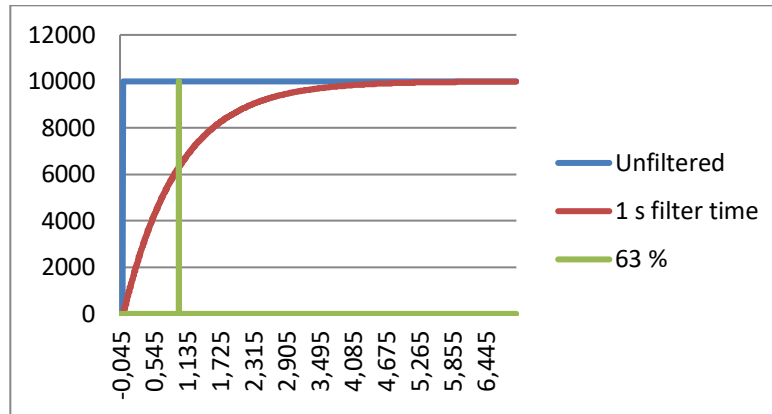

Figure 23.

2.5.4.4 *lout 1 Invert*2.5.5.4 *lout 2 Invert*2.5.6.4 *lout 3 Invert*

Inverts the analogue output signal:

- Maximum output signal = Minimum set value.
- Minimum output signal = Maximum set value.

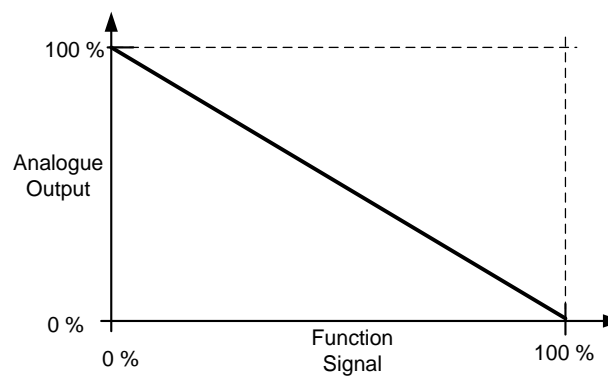

Figure 24.

2.5.4.5 *lout 1 Minimum*

2.5.5.5 *lout 2 Minimum*

2.5.6.5 *lout 3 Minimum*

0 = Set minimum value to 0 mA (0%)

1 = Set minimum value to 4 mA (20%)

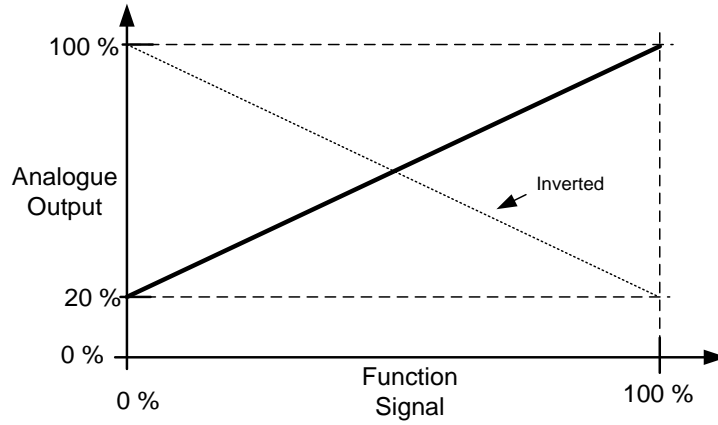

Figure 25.

2.5.4.6 *lout 1 Scale*

2.5.5.6 *lout 3 Scale*

2.5.6.6 *lout 4 Scale*

A scaling factor for an analogue output.

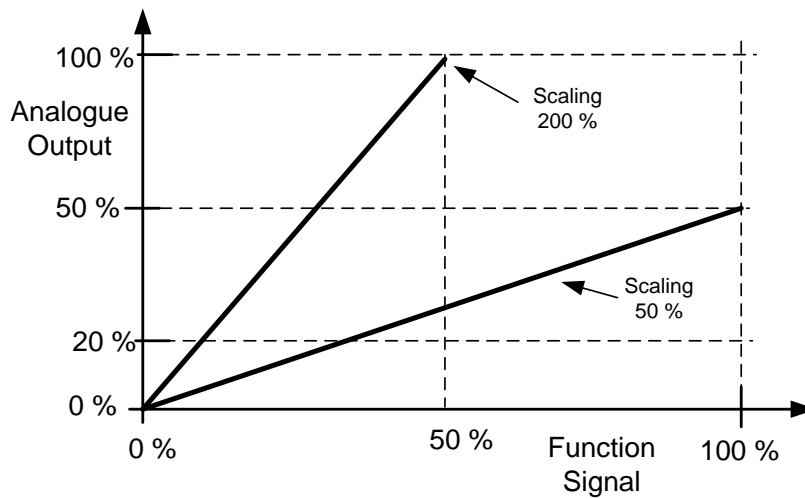

Figure 26.

2.5.4.7 *lout 1 Offset*

2.5.5.7 *lout 2 Offset*

2.5.6.7 *lout 3 Offset*

Add -100.0 to 100.0% to the analogue output.

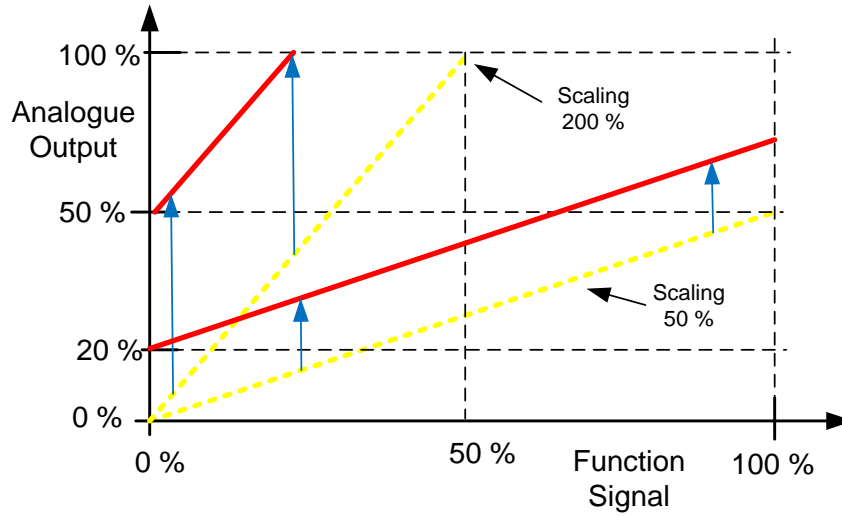

Figure 27.

#### 7.5.4 OPTIONS

##### *P2.5.7.1 Output Inversion ID1806*

With this parameter it is possible to select which output signals are inverted.

B00 = +1 = Inver Common Alarm

B01 = +2 = Invert Common Warning

B02 = +4 = Invert delayed output 1

B03 = +8 = Invert delayed output 2

##### *P2.5.7.2 DC Supervision Limit ID1454*

This parameter defines when FB Status Word B10 is high (ID68). The Bit is high when DC voltage is above the value set by this parameter.

##### *P2.5.7.3 CB Close Mode*

This parameter defines how the closing of circuit breaker is handled.

###### **0 = DC Voltage**

Normal AFE operation type circuit breaker control. The circuit breaker is closed when DC voltage is at a required level.

###### **1 = DC Voltage or Start Command**

The circuit breaker is closed when DC voltage is at the required level, or from a start command if DC is at a required level. This can be used when the breaker is opened, for example, by a stop command but DC remains high. It is useful when used in a battery system.

###### **2 = Start Command**

The circuit breaker is closed from a start command if DC is at a required level.

##### *P2.5.7.4 MCB At Stop Command*

The parameter defines the action for MCB when a stop command has been given.

###### **0 = Keep closed**

###### **1 = Open CB when drive has stopped**

##### *P2.5.7.5 MCB close delay*

The parameter defines the delay when RO2 is closed after the drive has determined that MCB can be closed.

***P2.5.7.6 Grid Code Breaker ID4531***

Select the breaker that Grid Code trip will open

0 = MCB 1

1 = NET Breaker

2 = NET U & f limit

This mode is not grid code compliant. NET breaker is open immediately when frequency or voltage is outside any of the grid code limits.

***P2.5.7.7 MCB Mechanical Close Delay ID1967***

Set here MCB mechanical closing delay, used for transformer magnetization function to change operation mode. And keep internal MCB status during the MCB mechanical delay.

## 7.6 LIMIT SETTINGS

### 7.6.1 CURRENT LIMITS

#### 2.6.1.1 Current Limit [A] ID 107

The parameter sets the current limit for the Grid Converter unit. Set the value to correspond to the maximum peak overload for the unit or if needed, to required short circuit current ( $I_{SC}$ ) when operating in Island to uGrid modes.

$I_S$  and  $I_{th} * 1,25$  currents are available when P2.6.1.4 Bridge Current limit is disabled, and active operation mode is Island or uGrid.

$I_{SC}$	Default	Max P2.6.1.4 = 0	Max P2.6.1.4 = 1
Current Limit Air Cooled	$I_L$	$I_H * 1,50$	$I_S$
Current Limit Liquid Cooled	$I_{th}$	$I_{th} * 1,05$	$I_{th} * 1,25$

**NOTE!** Set the current limit high enough so that limit is not reached in normal operation.

#### 2.6.1.2 Short Circuit Detection Level [%] ID 1620

This parameter defines the current level when the drive will start to feed reactive current to the short circuit, i.e. this is short circuit current detection level ( $I_{SCD}$ ).

This is instantaneous value, related to P2.1.3 Grid Converter Rated Current. ( $P2.1.3 * \sqrt{2}$ )

This value should be above the set current limit of the drive but below the (F1) over current trip limit ( $3,2-4 * I_H$ , depending on unit).

The recommendation is to set Short Circuit Level about 25 % higher than the value of the current limit for air cooled unit and 15 % higher for liquid cooled units. This will eliminate short circuit reactivation while already operating against current limit due current spikes.

**NOTE!** The function requires a uGrid Licence (P3.2 uGrid Licence)

**NOTE!** During the short circuit grid voltage will be low; it may require that UPS is used for auxiliary voltage that MCB is kept closed during short circuit.

Continues next page...

Example LC AFE unit 730 A 500 Vac :

Grid Converter Rated Current ( $I_{GCRC}$ ): 487 A ( $I_h$ )

Current Limit ( $I_{SCC}$ ) : 912 A ( $1,25 * I_h$ )

Short Circuit Detection Level ( $I_{SCD}$ ) :  $\frac{912 A}{487 A} * \sqrt{2} * 1.15 = 304 \%$

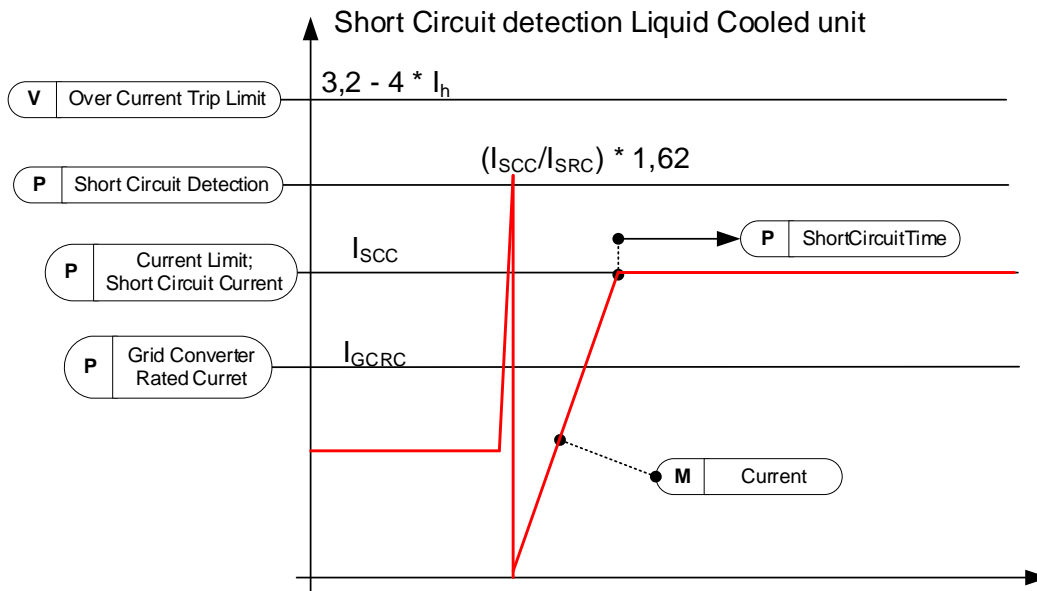

In this case Short Circuit Level 264% would be equal to Current Limit in rms. The recommended value for the Short Circuit Level in the case above is 304 %. The function will be disabled if a value above 499% is given.

Continues next page...



Example Air Cooled AFE unit 460 A 500 Vac :

Grid Converter Rated Current ( $I_{GCRC}$ ): 385 A ( $I_h$ )

Current Limit ( $I_{SC}$ ): 693 A ( $I_s$ )

Short Circuit Detection Level ( $I_{SCD}$ ) :  $\frac{693 A}{385 A} \times \sqrt{2} \times 1.25 = 319 \%$

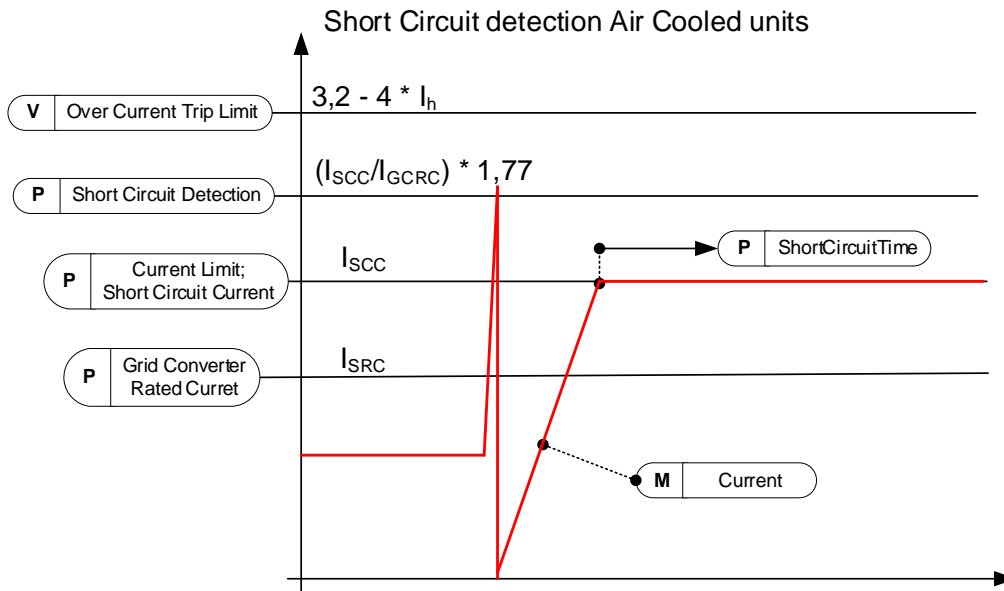

Figure 28.

### 2.6.1.3 Short Circuit Time [ms] ID 1515

The maximum time that the drive can operate against the current limit.

### 2.6.1.4 Bridge Current Limit [Enable / Disable] ID1517

In normal motoring drives  $I_s$  is the starting current below 30 Hz for short period of time to protect FR unit input bridge. Grid Converters are normally INU units, thus protective bridge current limit can be disabled.

In Grid Converter INU unit  $I_s$  must be enabled separately for short circuit current if current levels above  $I_h$  50 % over load currents are needed for air cooled units.

For Liquid cooled units this parameter enables current limit up to  $1,25 * I_{th}$ .

The bridge current limit can be disabled when the licence key has been given and the drive is connected to DC (INU unit) by setting parameter to 1 / Disable. If connected to AC grid (FC unit), this parameter must be kept at 0 / Enable to protect the unit.

#### 0 = Enabled

Bridge protection current limit is enabled, drive will not give  $I_s$  current to short circuit.

#### 1 = Disabled

Bridge protection current limit is disabled, drive can make  $I_s$  current to short circuit.

### 2.6.1.5 Short Circuit Fault Voltage Level

ID 1518

The BiPhase fault is detected by monitoring the supply voltage. Set this value lower than the supply voltage would be in normal operation.

This limit can be activated also for three phase faults if need by setting Control Options 2 B07 TRUE, Residual Voltage Limit

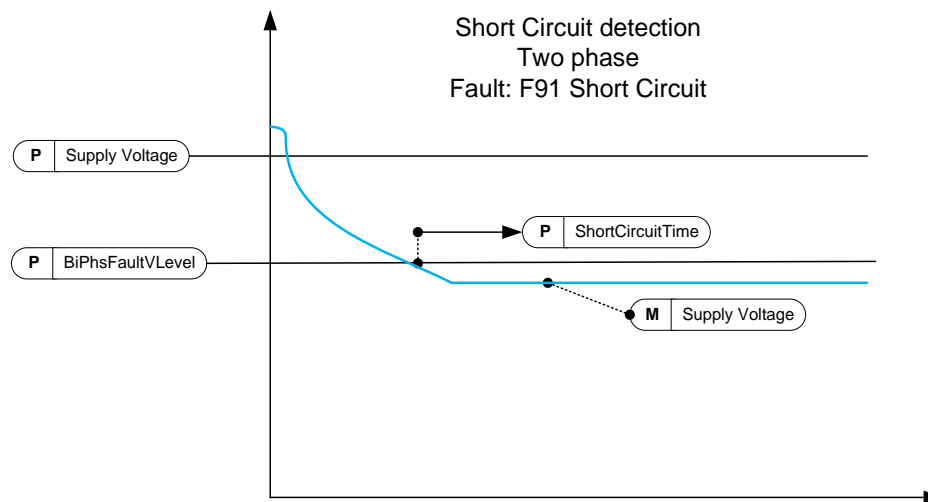

Figure 29.

### P2.6.1.6 Output Active Current Limit [%] ID1290 "OutputActCurLim"

This parameter sets the active current limit for the generator side operation of the regenerative unit. 100.0% is equal to nominal current. Generator Side operations is when power flows from DC side to AC side. Setting too low value may lead to over voltage fault even on situation when power is not mend to regenerate to grid side.

### P2.6.1.7 Input Active Current Limit [%] ID1289 "InputActCurrLim"

This parameter sets the active current limit for the motor side operation of the regenerative unit. 100.0% is equal to nominal current. Motoring Side operations is when power flows from AC side to DC side.

### P2.6.1.8 Software Over Current fault level ID1094

Software level Over Current Protection. This is instantaneous value, related to P2.1.3 Grid Converter Rated Current. ( $P2.1.3 * \sqrt{2}$ ). Drive stops to F1 Over Current Sub Code S4.

**7.6.2 POWER LIMITS****2.6.2.1 Output Power Limit ID1288**

This parameter sets the power limit for the generator side operation of the regenerative unit. 100.0% is equal to nominal current at nominal voltage at unit output terminals. Generator Side operations is when power flows from DC side to AC side. Setting too low value may lead to over voltage fault even on situation when power is not mend to regenerate to grid side.

**2.6.2.2 Input Power Limit ID1287**

This parameter sets the power limit for the motor side operation of the regenerative unit. 100.0% is equal to nominal current at nominal voltage at unit output terminals. Motoring Side operations is when power flows from AC side to DC side.

**2.6.2.3 Power Limit Increase Rate ID1502 "Limit.Inc.Rate"**

This parameter defines the limit increase rate. The limit will start to decrease immediately.

**P2.6.2.4 High Frequency Power Limit Function ID1703**

This parameter provides a high frequency power limit function for AFE. When the frequency exceeds this value, power is limited with 1 Hz slope. The value 0 = Not in use.

**P2.6.2.5 Stop Power Ramp Rate ID1812**

Defines ramp rate for power when stopping. Ramping disabled when negative value selected.

### 7.6.3 FREQUENCY LIMITS

NOTE: This functionality is not Grid Code functionality even if functionality may be similar.

#### 2.6.3.1 Line Low Frequency Trip Limit

If the drive output frequency goes below this level, the drive will trip to a line synch fault.

Use this limit as a final and immediate protection function for the grid or generator. In the protection group there are protection functions that will use OPT-D7 information.

The common tripping limit of the land based grid code standard is 47.5 Hz within 200 ms.

#### 2.6.3.2 Line High Frequency Trip Limit

If the drive output frequency goes above this level, the drive will trip to a line synch fault.

Use this limit as a final and immediate protection function for the grid or generator. In the protection group there are protection functions that will use OPT-D7 information.

The common tripping limit of the land based grid code standard is 50.2-51.5 Hz within 200 ms.

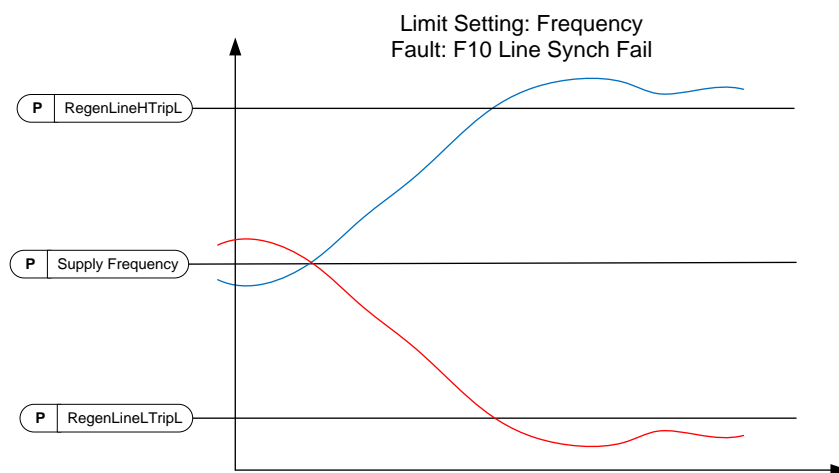

Figure 30.

## 7.6.4 MICRO GRID LIMITS

### 2.6.4.1 Current Limit Minimum

An active current limit from AC to DC direction. This limit affects the Island and uGrid operation modes but not the AFE operation mode.

### 2.6.4.2 Current Limit Maximum

An active current limit from DC to AC direction. This limit affects the Island and uGrid operation modes but not the AFE operation mode.

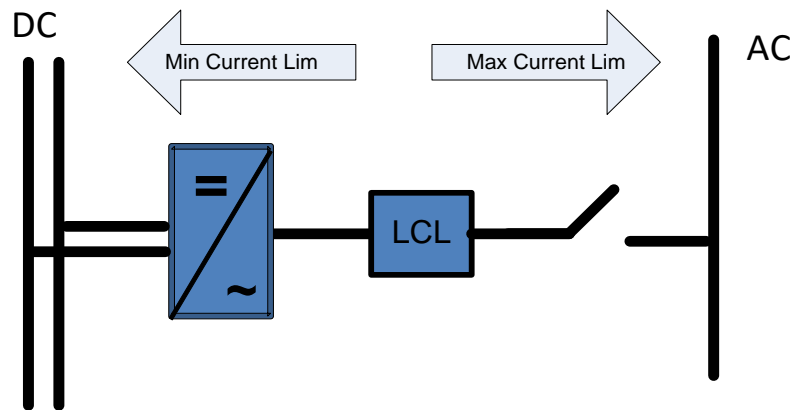

Figure 31.

### 2.6.4.3 Maximum Limit Increase Rate

This parameter defines the increase rate for the current limit from DC to AC direction.

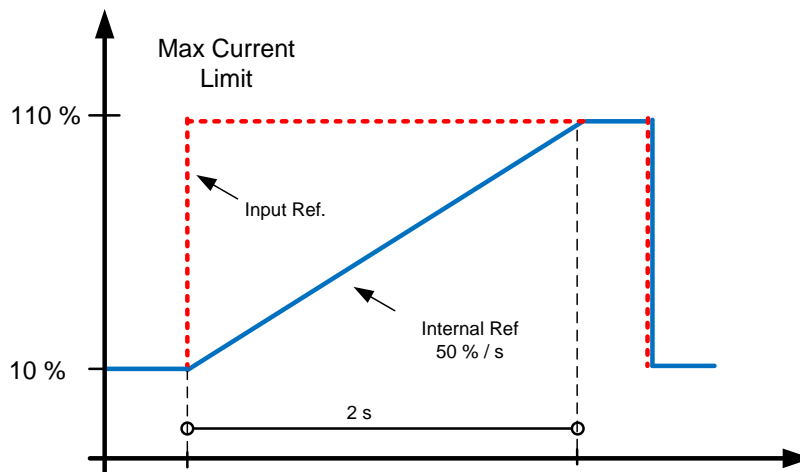

Figure 32.

### 2.6.4.4 Current Limit Kp

The gain for the current limit operation.

### 2.6.4.5 *Current Limit Ti*

The integration time for the current limit operation.

### 2.6.4.6 *Current Limit Max Minimum*

This parameter defines the minimum limit for the maximum current limit.

Use this function to limit minimum when PLC control value to zero. The value zero will cause instability in the control. Depending on the system, the value is usually between 1% and 5%.

### 2.6.4.7 *Current limit to Zero Mode*

Defines how the maximum current limit is handled in the STOP state.

In a starting situation, the current can increase above the reference when the grid frequency is below the base frequency. This function will decrease the starting current in starting situations.

0 = Current limit is kept at parameter level in STOP state.

1 = Current limit is set to minimum level in STOP state.

## 7.6.5 DC VOLTAGE REGULATORS

### P2.6.5.1 *Under Voltage Limit ID1524*

This parameter provides the under voltage regulator limit for Island and Micro Grid operation. A percentage value related to the nominal AC voltage of the drive.

$$DC \text{ Under Voltage Limit} = \text{Unit Nom AC Voltage} * 1,35 * \text{Under Voltage Limit}$$

$$500 \text{ Vac unit: } 439 \text{ Vdc} = 500 \text{ Vac} * 1,35 * 65,00 \%$$

$$690 \text{ Vac unit: } 605 \text{ Vdc} = 690 \text{ Vac} * 1,35 * 65,00 \%$$

### P2.6.5.2 *Over Voltage limit ID1523*

This parameter provides the over voltage regulator limit for Island and Micro Grid operation. A percentage value related to the nominal AC voltage of the drive.

$$DC \text{ Under Voltage Limit} = \text{Unit Nom AC Voltage} * 1,35 * \text{Over Voltage Limit}$$

$$500 \text{ Vac unit: } 810 \text{ Vdc} = 500 \text{ Vac} * 1,35 * 120,00 \%$$

$$690 \text{ Vac unit: } 1117 \text{ Vdc} = 690 \text{ Vac} * 1,35 * 120,00 \%$$

**P2.6.5.3 Brake chopper ID504 "Brake Chopper"**

When the AC drive is decelerating the motor, the inertia of the motor and the load are fed into an external brake resistor. This enables the drive to decelerate the load with a torque equal to that of acceleration (provided that the correct brake resistor has been selected). See separate Brake resistor installation manual. Brake chopper test mode generates pulse to resistor every second. If the pulse feedback is wrong (resistor or chopper is missing) fault F12 is generated.

**0 = "Not Used" - No brake chopper used**

Brake chopper not active or present in the DC link. **NOTE:** The overvoltage controller level is set to a little lower, see parameter P2.6.5.2.

**1 = "On, Run" - Brake chopper in use and tested when running.**

The drive's own brake chopper is activated and operational when the drive is in Run state. The drive also sends test pulses for feedback from the brake resistor.

**2 = "On, Run+Stop" - Used and tested in READY state and when running**

Brake chopper is also active when the drive is not in Run state. This option can be used, for example, when other drives are generating but energy levels are low enough to be handled with only one drive.

**3 = "On, No test" - Used when running (no testing)**

Brake chopper is active in Run state but no test pulse to resistor is generated.

**Note:** In the system menu, there is a parameter "InternBrakeRes". This parameter is used for brake resistor overheating calculations. If an external brake resistor is connected to the drive the parameter should be set to 'Not connected' to disable temperature calculation for the brake resistor.

**P2.6.5.4 Brake Chopper Level ID1267 "BrakeChopperLeve"**

Brake chopper control activation level in volt. This parameter is active when "OverVolt.Ref.Sel" is 2 / "BrakeChLevel"

For 400V Supply:  $400 * 1.35 * 1.18 = 638V$

For 500V Supply:  $500 * 1.35 * 1.18 = 808V$

For 690V Supply:  $690 * 1.35 * 1.18 = 1100V$

**P2.6.5.5 DC Limit Control Kp ID1525****P2.6.5.6 DC Limit Control Ti ID1526****P2.6.5.7 HighMCBCloseLim ID1251****P2.6.5.8 LK Low DC ID1813**

Enter license key to enable low dc voltage start function.

## 7.7 DRIVE CONTROL

### 2.7.1 *Switching Frequency* ID601

The switching frequency of the IGBT Bridge in kHz. Changing the default value can have an impact on the LCL filter operation.

### 2.7.2 *AFE Options 1* ID 1463

This packed bit word is made for enabling/disabling different control options for the regeneration control.

**B0** = Disable DCV reduction with a reactive reference generation with high line voltage.

**B1** = Disable LCL reactive power compensation.

**B5** = Disable all harmonic elimination compensation.

This is active by default. When activated, this function will reduce little 5<sup>th</sup> and 7<sup>th</sup> harmonics. This will not reduce harmonics of the grid, only the harmonics of the drive.

**B8** = Enable double pulse synchronisation.

This option will generate two synchronisation pulses instead of one. It can help the synchronisation on a weak grid.

**B9** = Enable soft synchronisation ( $\geq$  FI9).

This function enables zero crossing detection on drives that are FI9 or bigger. When this is active and there is a connection to the grid when the drive is in the STOP state, Supply Frequency is updated by the detected frequency. May not work correctly if DC-Link voltage is not approximately  $1,35 * \text{Grid Voltage}$ .

**B10** = Fuse burning mode when operating with parallel power sources.

Does not set voltage to immediately to zero when short circuit trigger happens.

**B12** = Enable floating DC reference. DC-link voltage will follow the line voltage.

DC Voltage is increased when supply voltage is higher than set Grid Nominal Voltage.

When the drive is in the RUN state, it can detect the Supply Voltage. If the supply voltage changes, also the internal DC Reference is changed so that DC voltage is:

$$DC \text{ Voltage} = \text{MAX}(\text{SupplyVoltage}, \text{GridNomVoltage}) * 1,35 * DC \text{ Reference}$$

**B13** = Enable use of D7 board for start synchronisation.

When an OPT-D7 board is installed, this bit will activate the synchronisation by using a voltage angle and frequency information from the D7 board. The phase order must be same in both the OPT-D7 and input phases. It is also necessary to keep the frequency on the positive side. The frequency of the D7 board can be the same as a Supply Frequency but the phase order can be still wrong.



### 2.7.3 AFE Options 2 ID 1464

This packed bit word is made for enabling/disabling different control options for the regeneration control.

**B11** = New Current Controller.

More robust when current exceed current limit in normal operation.

### 2.7.4 AFE Options 3 ID 1466

This packed bit word is made for enabling/disabling different control options for the regeneration control.

**B6** = Drooping disabled while limit regulator active.

When DC Link limit regulators or current limit regulators are active drooping is disabled.

**B7** = Enable modulator change during short circuit mode.

If software modulator 2 is active drive will change modulator to 1 in case of short circuit.

### 2.7.5 AFE Options 4 ID 1467

This packed bit word is made for enabling/disabling different control options for the regeneration control.

**B2** = +2 = Disable OPT-D7 THD measurement.

### 2.7.6 Start Delay ID 1500

This parameter defines a starting delay when a run command is given. When programming different delays to parallel units, the units will start in sequence. This is necessary in parallel units to make sure that the synchronisation does not happen simultaneously in all the drives. A simultaneous start can lead to a failed synchronisation. The recommended value between the drives is 500 ms.

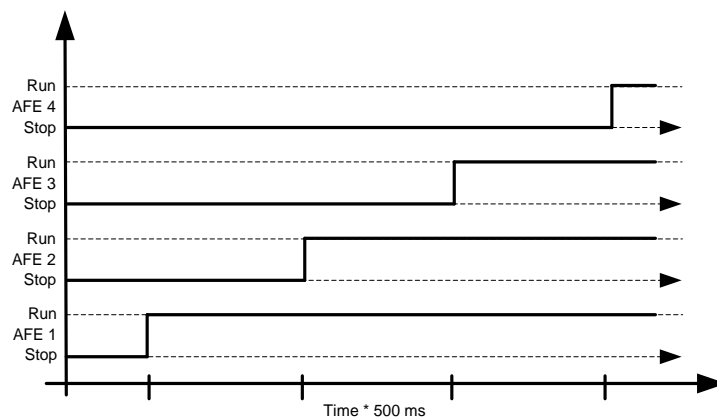

Figure 33.

### 2.7.7 *Modulator Type (ID1516)*

With this parameter you can change the modulator type. With an ASIC (HW) modulator, the current distortion is lower, but losses are higher compared to a software modulator. It is recommended to use Software modulator 1 as a default option.

**0 = Hardware modulator:** an ASIC modulator, with a classical third harmonic injection. The spectrum is slightly better compared to Software 1 modulator.

**1 = Software modulator 1:** A symmetric vector modulator with symmetrical zero vectors. The current distortion is smaller than with Software modulator 2 if boosting is used.

**2 = Software modulator 2:** A symmetric BusClamb, in which one switch always conducts 60 degrees either to a negative or a positive DC-rail. Switching losses are reduced without different heating of upper and lower switches. The spectrum is narrow. Not recommended for parallel units.

**3 = Software modulator 3:** An unsymmetric BusClamb, in which one switch always conducts 120 degrees to a negative DC-rail to reduce switching losses. The upper and lower switches are unevenly loaded and the spectrum is wide. Not recommended for parallel units.

**4 = Software modulator 4:** A pure sine wave, sinusoidal modulator without harmonic injection. It is dedicated to be used, for example, in back-to-back test benches to avoid a circulating third harmonic current. The required DC voltage is 15% higher compared to other modulator types.

### 2.7.8 *Control Options 1 ID1707*

**B01 = +2 = Bypass minimum DC Voltage reference limit.**

Default minimum limit is 105 %, with this bit minimum limit is set to 48 %.

**B03 = +8 = Disable D7 frequency monitoring for diagnostic. Used for testing purposes.**

**B04 = +16 = Disable D7 voltage monitoring for diagnostic. Used for testing purposes.**

**B05 = +32 = Keep frequency drooping while synchronising to external grid.**

**B06 = +64 = Enable external grid contactor closing in STOP state.**

**B07 = +128 = Enable changing (temporally) MCB Control output. Used to disable MCB close for testing purposes.**

**B10 = +1024 = Bypass normal DC-Link voltage reference level for 500 Vac unit.**

**B11 = +2048 = Enable drive stop when OPT-D7 voltage is below P2.9.6.2 VoltLowWarnLim**  
This function is used to keep AFE-INU system operational during short circuit on grid side given that inertia of INU side will keep DC high enough for long enough.

### 2.7.9 *Control Options 2* *ID1798*

**B00** = +1 = Reserved.

**B02** = +4 = OPT-D7 simulation.

When OPT-D7 board is not used, it is possible to use Analogue Input 3 and 4 ID write function to give the grid the Line Frequency D7 (ID1654) and Line Voltage D7 (ID1650). This enables use of grid protection functions without OPT-D7 board. Note that both line frequency and line voltages needs to be given.

**B03** = +4 = Disable fast DC-Reference functionality

**B04+ B05** = +48 = DCV-ripple compensation

**B06** = +64 = Enable Double Sampling.

Reduces aliasing in current measurement but increases system load slightly. May be used on battery system where having accurate zero current reference is important. Grid Code functionality will enable double sampling automatically. Use B08 to disable.

**B07** = +128 = Residual Voltage Monitor, P2.6.1.5 SC Voltage Limit for three phase short circuit

**B08** = +256 = Disable Grid Code double sampling activation.

### 2.7.10 *Operation Time* *ID1855*

This parameter stores the operation time. When the application is reloaded, operation hours will go to zero if this parameter is not updated.

The unit of the monitoring signal is h with two decimals.

Parameter is in this format:

XX (Years) XX (Months) XX (Days) XX (Hours) XX Minutes

1211292359 -> 12 years, 11 months, 29 days, 23 hours and 59 minutes.

**7.7.1 AFE CONTROL**

*P2.7.11.1 Dynamic Support Kp ID1797*

*P2.7.11.2 Synch Kp ID1457*

This parameter sets the gain of the synchronisation controller used to synchronise the switching to the supply.

*P2.7.11.3 Synch Ti ID1458*

This parameter sets the time constant of the controller used to synchronise the switching to the supply (15 equals 7ms).

*P2.7.11.4 Active Current Kp ID1455*

This parameter sets the gain of the controller for the active current of the regenerative unit.

*P2.7.11.5 Active Current Ti ID1456*

This parameter sets the time constant of the controller for the active current of the regenerative unit (15 equals 1.5ms).

*P2.7.10.6 Synch. Kp Start ID1300*

*P2.7.11.7 Voltage Control Kp ID1451*

This parameter sets the gain for the DC link PI voltage controller.

*P2.7.11.8 Voltage Control Ti ID1452*

This parameter sets the time constant in ms of the DC link PI controller.

*P2.7.11.9 Modulator #2 DPWM Optimization ID1682*

This function enables use of Grid Converter Modulator used with parallel Grid Converters. Active only when Software Modulator #2 is used. Operation is same as software modulator 2 when mindex > 75 % and same as software modulator 1 when mindez < 25 %.

*P2.7.11.10 AdvancedOptions1 ID1560*

*P2.7.11.11 AdvancedOptions2 ID1561*

*P2.7.11.12 AdvancedOptions4 ID1563*

*P2.7.11.13 AdvancedOptions5 ID1564*

*P2.7.11.14 AdvancedOptions6 ID1565*

**7.7.2 IDENTIFICATION**

*P2.7.12.1 IU Offset* *ID668*

Identified U phase current measurement offset, identified during identification run.

*P2.7.12.2 IV Offset* *ID669*

Identified U phase current measurement offset, identified during identification run.

*P2.7.12.3 IW Offset* *ID670*

Identified W phase current measurement offset, identified during identification run.

*P2.7.11.4 DCLinkMeasCalib* % *ID549*

Offset for DC-Link measurement, used to balance e.g. parallel units over and/or under voltage controllers.

**7.7.3 ACTIVE COMPENSATION**

*P2.7.13.1 DC Ripple Compensation Kp* *ID1897*

Gain for DC-Link ripple compensation.

*P2.7.13.2 DC Ripple Compensation Phase* *ID1898*

Phase for DC-Ripple compensation.

*P2.7.13.3 DC Ripple Compensation Frequency* *ID1899*

Frequency for DC-Link ripple compensation.

*P2.7.11.4 HCompDropp* *ID1938*

*P2.7.11.5 HCompDroopHi* *ID1939*

*P2.7.13.6 Id LCL Compensation* % *DI4533*

This can be used to compensate LCL part from the Reactive Current and Power monitoring signals.

## 7.8 MASTER/FOLLOWER

The OPTD2 board jumper selection is handled from application, set all drives jumper to position X5:2-3. This board also has a CAN communication option that is useful for multiple drive monitoring with VACON® NCDrive PC software when commissioning Master Follower functions or line systems. Older boards has X6, leave this to ON (X6:1-2).

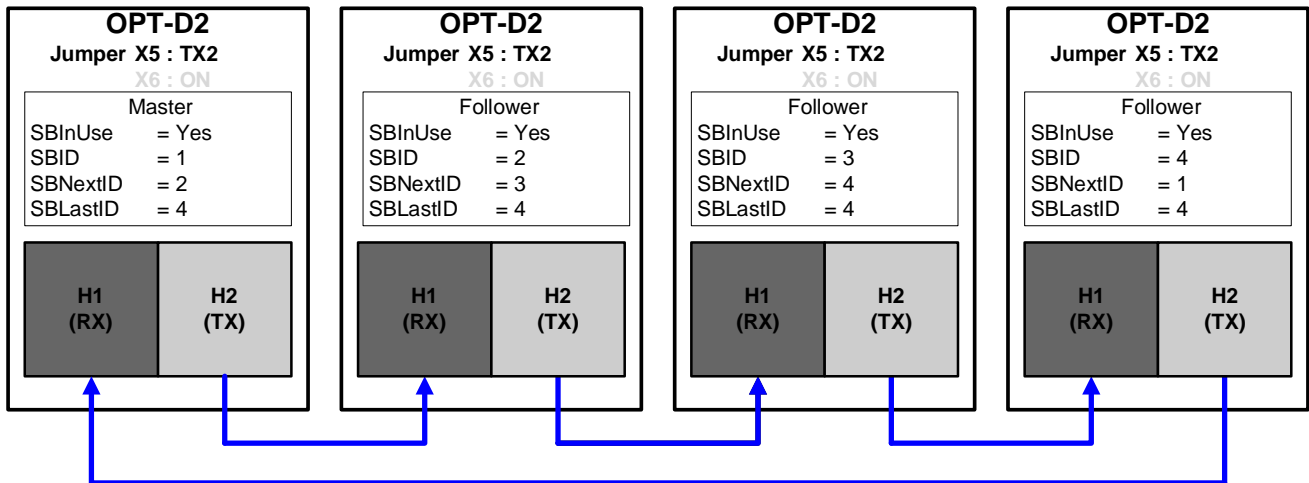

Figure 1. Figure 7-1. System bus physical connections with the OPT-D2 board

### P2.8.1 Master/Follower selection ID1324 "MF Mode"

Select the Master Follower mode. When the drive is a follower, the Run Request command is monitored from Master but all references are selectable by parameters.

0 = No Communication

System bus is deactivated

1 = Master Standard Mode

Drive sends control word and DC-Voltage reference to follower drive.

2 = Follower Standard Mode

Drive receives control word from Master and sends some diagnostic information to the Master drive.

3 = Master DriveSynch Mode

Master sends full modulation information to follower drives and followers follow this information exactly. All units need to have same switching frequency parameter setting.

4 = Follower DriveSynch Mode

Master sends full modulation information to follower drives and followers follow this information exactly. Changing controlling parameters e.g. DC Voltage Reference in follower drives do not affect in follower drives operation, followers follow master. All units need to have same switching frequency parameter setting.

**5 = Master D2-Synch Mode**

Drive sends control word and DC Voltage Reference to follower drive.

Same as Standard mode but modulation is synchronized between the drives. This will eliminate circulating currents, but all drives have individual control of current.

**6 = Follower D2-Synch Mode**

Drive receives control word and DC Voltage Reference from Master and sends some diagnostic information to the Master drive.

Same as Standard mode but modulation is synchronized between the drives. This will eliminate circulating currents, but all drives have individual control of current e.g. DC Voltage Reference in follower will affect the operation of follower drives see also ID1081 Follower DC Reference.

***P2.8.2 Follower DC Reference ID1081***

Select follower drive DC Reference for Master Follower operation modes 2 and 6

**0** = Master Reference

Follower drives uses master drive DC Voltage reference

**1** = Own DC Reference

Follower drives uses own reference chains.

***P2.8.3 MF License ID1994***

License to activate Master Follower modes 2 and 3.

***P2.8.4 Follower Fault ID1542***

Defines the response in the Master drive when a fault occurs in any of the follower drives.

**0** = No response

**1** = Warning

**2** = Fault

## 7.9 PROTECTIONS

### 7.9.1 GENERAL SETTINGS

#### 2.9.1.1 *Thermistor Fault Response*

- 0 = No response
- 1 = Warning
- 2 = Fault

Setting the parameter to 0 will deactivate the protection.

#### 2.9.1.2 *OverTemp Response*

- 2= Fault
- 3= Fault, Open MCB
- 4= Fault, Open NET CB
- 5 = Fault, Open Main & NET CB

#### 2.9.1.3 *Overvoltage Response*

- 2= Fault
- 3= Fault, Open MAIN CB
- 4= Fault, Open NET CB
- 5 = Fault, Open Main & NET CB

#### 2.9.1.4 *LCL Temperature input monitor*

This parameter defines a response to the input filter overtemperature fault. The fault is monitored through a digital input.

#### 7.9.1.1 Charging fail

There are two protection function for charging, one is monitoring always if the DC-Link voltage does not reach the minimum level to close MCB regardless of if charging function is used or not. Other one is monitoring if the drive voltage does not reach the minimum MCB closing level when drive own charging control is used. First protection function is working only if power unit can get enough voltage that measurement data can be received.

#### 2.9.1.5 **Max Charge Time**

When the drive charging options are used, this parameter defines the maximum time limit for charging.

#### 2.9.1.6 *MCB at Fault*

Defines action for the main circuit breaker when the drive has a fault.

F1 Over Current, F31 Hardware IGBT and F41 Software IGBT will open MCB immediately regardless of the setting of this parameter.

- 0 = Keep closed
- 1 = Open at any fault situation



**P2.9.1.7 Quick Stop Response ID1758**

This function will stop the drive at any case. This parameter is used to select which action is shown on keypad.

- 0 = No indication
- 1 = Warning
- 2 = Fault

**P2.9.1.8 Reactive Error Trip Limit ID1759**

Limit for the reactive current for the line fault detection, when the reactive current is less than the value of parameter Line Synch fault.

**P2.9.1.9 MCB Fault Delay ID1521**

The delay for the main circuit breaker open fault. The delay between the control relay close command of the main circuit breaker and the acknowledge signal of the main circuit breaker. If the acknowledge signal is not received within this time, a fault F64 will be generated.

**P2.9.1.10 Line Phase Supervision ID702**

Defines the response when the drive notices that one of the line phases is missing.

This function is same as output phase supervision in motoring drives.

Selections 1 – 3: Current measurement has detected that there is no current in one phase, or one phase current is considerably different from other phases.

Selections 4: is actively trying to detect if one or more phases are missing. This method can detect phase losses accurately in near zero current situations but causes unsymmetrical voltage with unsymmetrical load and weak network. Works in AFE mode only, recommended to active when using Grid Codes. Requires system software NXP00002V206.

Selection 3 is combination of selection 2 and 4. Actively monitoring phases and monitoring current imbalance.

- 0 = No response
- 1 = Warning
- 2 = Fault
- 3 = Fault & F10 One Phase
- 4 = F10 One Phase

***P2.9.1.11 Response to the 4mA reference fault ID700***

The 4 mA protection monitors the analogue input signal level from Analogue Input 1 and Analogue Input 2. The monitoring function is active when the signal Custom Minimum is bigger than 16.00% and the mode is defined as a living zero. A fault or warning is generated when the signal goes below 3.5 mA for 5 seconds or below 0.5 mA for 0.5 seconds.

- 0 = No response
- 1 = Warning
- 2 = Fault

***P2.9.1.12 Reactive Current Limit Response ID1981***

This function can be used to generate a fault or a warning when the reactive current exceeds 110% value.

- 0 = No response
- 1 = Warning
- 2 = Fault

***P2.9.1.13 Klixon Response ID782***

Select the response for klaxon inputs.

- 0 = No Action
- 1 = Warning, Warning
  - Both klixon inputs give a warning
- 2 = Warning, Fault
  - Klixon input 1 will generate warning and klixon input 2 will generate fault
- 3 = Fault, Fault
  - Both klixon inputs give a fault

***P2.9.1.14 Ambient Temp Response ID784***

Select the response for ambient temperature digital input.

***P2.9.1.15 Input Switch Response ID785***

Select the response for input switch digital input.

P2.9.1.16 *FaultWarnIndicat* ID1940

With this parameter its possible to select how warning and fault indication as handled to digital outputs and to fieldbus

0 = Static

Static signal, as long as warning or fault is active. Warning will disappear after 10 second when warning situation has passed. Fault requires a reset always.

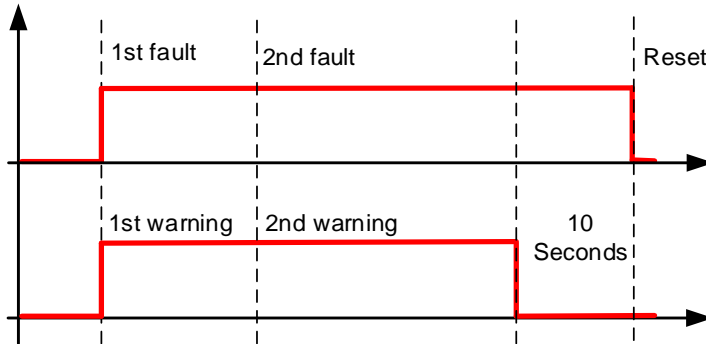

1 = Toggle

If there is a warning or fault already active a new warning or fault will toggle signal for one second.

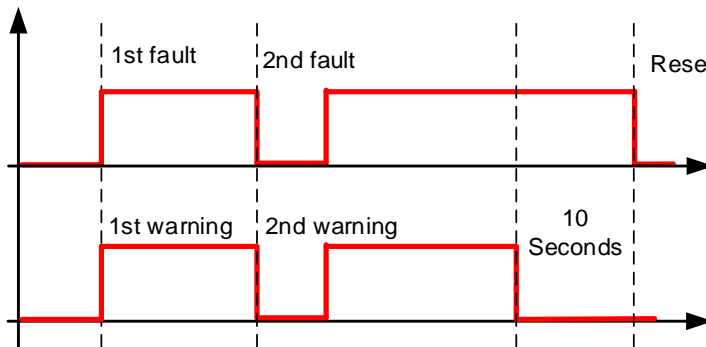

2 = Marine

If there is a warning or fault already active a new warning or fault will toggle signal for one second. Warning status will not disappear automatically after 10 second, to make warning signal disappear a reset signal is needed.

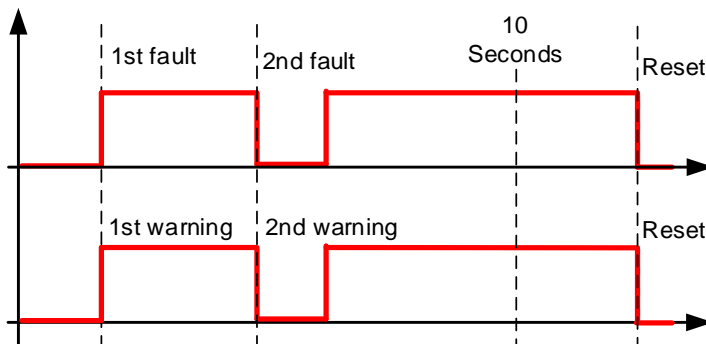

**7.9.2 PT-100**

The temperature protection function is used to measure temperatures and issue warnings and/or faults when the set limits are exceeded. The marine application supports two OPT-BH and OPT-B8 board simultaneously. One can be used for the motor winding and one for the motor bearings.

**P2.9.2.1 Number of used inputs in board 1 ID739 "Board1 Channels"**

Select used temperature sensor combination with this parameter. See also the VACON® I/O boards manual.

0 = Not used (ID Write, value of maximum temperature can be written from fieldbus)

1 = Sensor 1 in use

2 = Sensor 1 & 2 in use

3 = Sensor 1 & 2 & 3 in use

4 = Sensor 2 & 3 in use

5 = Sensor 3 in use

**Note:** If the selected value is greater than the actual number of used sensor inputs, the display will read 200°C. If the input is short-circuited the displayed value is –30°C.

**P2.9.2.2 Board 1 Temperature response ID740 "Board1 Response"**

0 = No response

1 = Warning

2 = Fault, stop mode after fault according to Stop Function

3 = Fault, stop mode after fault always by coasting

**P2.9.2.3 Board 1 warning limit ID741 "Board1Warn.Limit"**

Set here the limit at which the PT100 warning will be activated.

When individual warning and fault limits are activated this is first board first channel (1A).

**P2.9.2.5 Board 1 fault limit ID742 "Board1 Fault Lim."**

Set here the limit at which the PT100 fault (F56) will be activated.

When individual warning and fault limits are activated this is first board first channel (1A).

**P2.9.2.5 Number of used inputs in board 2 ID743 "Board2 Channels"**

If you have two temperature sensor boards installed in your AC drive you can choose here the combination inputs in use in the second board. See also the VACON® I/O boards manual.

0 = Not used (ID Write, value of maximum temperature can be written from fieldbus)

1 = Sensor 1 in use

2 = Sensor 1 & 2 in use

3 = Sensor 1 & 2 & 3 in use

4 = Sensor 2 & 3 in use

5 = Sensor 3 in use

#### ***P2.9.2.6 Board 2 Temperature response ID766 "Board2 Response"***

0 = No response

1 = Warning

2 = Fault, stop mode after fault according to Stop Function

3 = Fault, stop mode after fault always by coasting

#### ***P2.9.2.7 Board 2 warning limit ID745 "Board2 Warn. Lim"***

Set here the limit at which the second temperature sensor board warning will be activated. When individual warning and fault limits are activated this is second board first channel (2A).

#### ***P2.9.2.8 Board2 fault limit ID746 "Board2 FaultLim"***

Set here the limit at which the second temperature sensor board fault (F61) will be activated. When individual warning and fault limits are activated this is second board first channel (2A).

#### **7.9.2.1 Individual channel monitoring**

Individual channel monitoring is activated by setting one of the warning limits (per board) different than zero. Common limits in above parameters will be channel A warning and fault limits. Channel B and C limits are set with below parameters.

##### ***P2.9.2.9.1 Channel 1B Warn ID764***

##### ***P2.9.2.9.2 Channel 1B Fault ID765***

First board second (1B) channel warning and fault limits.

##### ***P2.9.2.9.3 Channel 1C Warn ID768***

**P2.9.2.9.4 Channel 1C Fault ID769**

First board third (1C) channel warning and fault limits.

**P2.9.2.9.5 Channel 2B Warn ID770****P2.9.2.9.6 Channel 2B Fault ID771**

Second board second (2B) channel warning and fault limits.

**P2.9.2.9.7 Channel 2C Warn ID772****P2.9.2.9.8 Channel 2C Fault ID773**

Second board third (2C) channel warning and fault limits.

**7.9.3 EARTH FAULT****2.9.3.1 EarthFlt Response**

2= Fault

3= Fault, Open MCB

4= Fault, Open NET CB

5 = Fault, Open Main & NET CB

**2.9.3.2 EarthFaultLevel**

This parameter defines the maximum level of earth current in % of the unit current.

**7.9.4 FIELD BUS****2.9.4.1 Fieldbus Fault Slot D ResponseID733****2.9.4.2 Fieldbus Fault Slot E ResponseID761**

Set the response for a fieldbus fault if the active control place is fieldbus. For more information, see the relevant Fieldbus Board Manual.

0 = No response

1 = Warning

2 = Fault, stop mode after fault according to Stop Function

**2.9.4.3 FB WD Time**

Delay time to a fieldbus fault when the pulse from PLC is missing. Setting the time to zero will disable the monitoring function.

**7.9.5 EXTERNAL FAULT**

*2.9.5.1 Response to External Fault 1 ID701 "External Fault 1"*

*2.9.5.2 Response to External Fault 2 ID1504 "External Fault 1"*

Defines response when a digital input signal is used to give signal about an external condition to which the drive needs to react. The external warning/fault indication can be connected to a digital output.

0 = No response

1 = Warning

2 = Fault

*2.9.5.3 External fault delay*

Defines the delay for an external fault, and affects both external fault inputs.

### 7.9.6 GRID VOLTAGE D7

This function monitors the grid voltage by using measurement from the OPT-D7 board. When Grid Codes are active this function is disabled.

#### P2.9.6.1 Voltage D7 Response ID1626

0 = No response

1 = Warning

2 = Fault

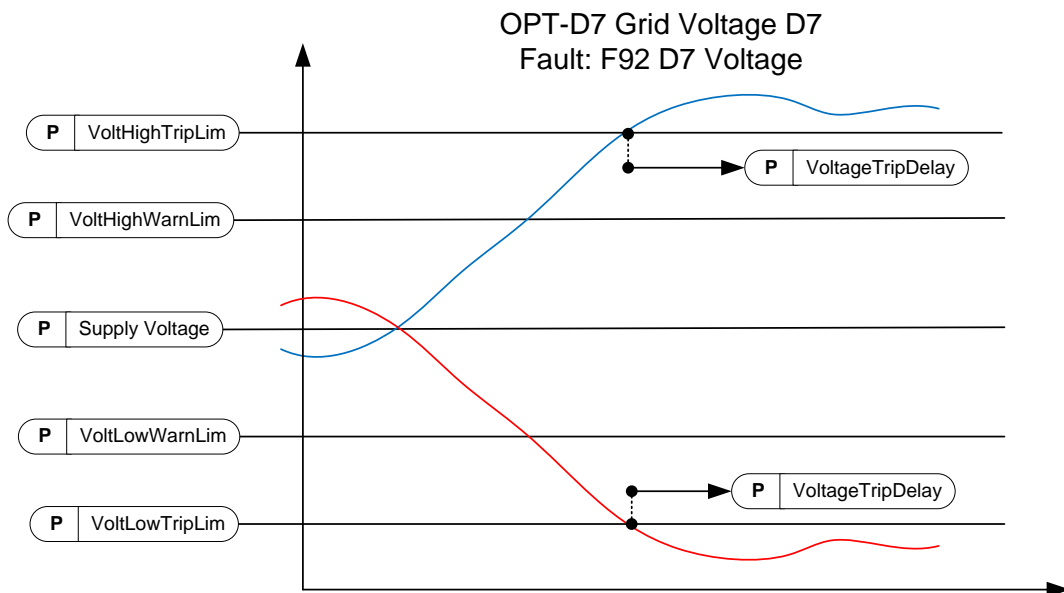

Note: Low Voltage trip from D7 board is disabled if drive has detected Short Circuit

Figure 2.

#### P2.9.6.2 Voltage Low Warning Limit ID1893

Low limit for a warning indication. A percentage value from a set supply voltage parameter.

#### P2.9.6.3 Voltage Low Trip Limit ID1899

Low limit for a fault indication. A percentage value from a set supply voltage parameter. The common tripping limit of the land based grid code standard is 80 % of  $U_n$  within 200 ms.

#### P2.9.6.4 Voltage High Warning Limit ID1895

High limit for a warning indication. A percentage value from a set supply voltage parameter.



*P2.9.6.5 Voltage High Trip Limit ID1799*

High limit for a fault indication. A percentage value from a set supply voltage parameter.  
The common tripping limit of the land based grid code standard is 115 % of Un within 200 ms.

*P2.9.6.6 Voltage Trip Delay ID1898*

Delay to a fault when the voltage has exceeded the fault levels.

### 7.9.7 GRID FREQUENCY

A monitoring function for the drive output frequency and the measured frequency from OPT-D7. Will also trip this when operating in pure AFE mode. When Grid Codes are active this function is disabled. See also G2.16.5 OPT-D7 Limits that defined frequency and voltage range where OPT-D7 measurements are considered to be valid.

**NOTE:** This functionality is not Grid Code functionality even if functionality may be similar.

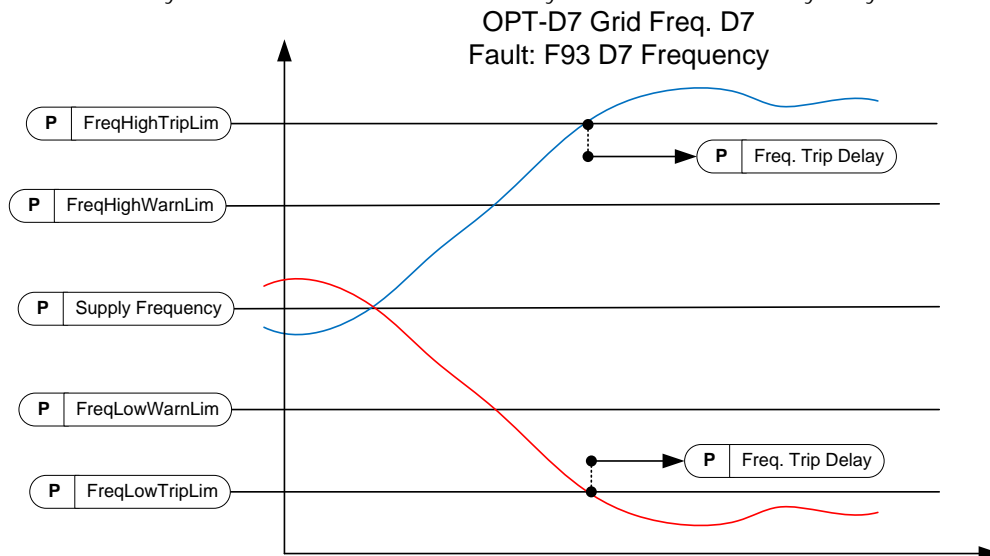

Figure 3.

#### P2.9.7.1 Freq. Supply Response ID1627

- 0 = No response
- 1 = Warning
- 2 = Fault

#### P2.9.7.2 Freq. D7 Response ID1628

- 0 = No response
- 1 = Warning
- 2 = Fault

#### P2.9.7.3 Freq. Low Warning Limit ID1780

Low limit for a warning indication. A percentage value from a set supply frequency parameter. This also limits the adjusted frequency references.

#### P2.9.7.4 Freq. Low Trip Limit ID1781

Low limit for a fault indication. A percentage value from a set supply frequency parameter. Use G2.6.3 Frequency limits for final and immediate protection.

The common tripping limit of the land based grid code standard is 47.5 Hz within 200 ms.

#### P2.9.7.5 Freq. High Warning Limit ID1783

High limit for a warning indication. A percentage value from a set supply frequency parameter. This also limits the adjusted frequency references.

**P2.9.7.6 Freq. High Trip Limit ID1784**

High limit for a fault indication. A percentage value from a set supply frequency parameter. Use G2.6.3 Frequency limits for final and immediate protection.

The common tripping limit of the land based grid code standard is 50.2-51.5 Hz within 200 ms.

**P2.9.7.7 Freq. Trip Delay ID1785**

Delay to a fault when the frequency has exceeded the fault levels.

**7.9.8 SUPPLY VOLTAGE**

There is a tripping function for the drive output voltage. It is possible that the drive output voltage is higher (or lower) than the grid voltage, depending on the voltage compensation for LCL and transformer. When Grid Codes are active this function is disabled.

**P2.9.8.1 Voltage, Supply response ID1629**

0 = No response  
1 = Warning  
2 = Fault

**P2.9.8.2 Voltage Low Trip Limit ID1891**

When the supply voltage drops below this limit, the drive will trip to an F70 Supply voltage fault. If the drive is already at the current limit, this low voltage trip limit is not active.

**NOTE!** OPT-D7 is not used for detection.

Use this function for the final protection function for the grid or the generator. Delay to trip is 150 ms. The protection group has functions that use OPT-D7 for voltage level protection.

**P2.9.8.3 Voltage Low Warning Limit ID1880**

When the supply voltage drops below this limit, the drive will give a warning. If the drive is already at the current limit, this low voltage trip limit is not active.

**NOTE!** OPT-D7 is not used for detection.

**P2.9.8.4 Voltage Low Warning Limit ID1881**

When the supply voltage increases above this limit, the drive will give a warning.

**NOTE!** OPT-D7 is not used for detection.

**P2.9.8.5 Voltage High Trip Limit D1992**

When the supply voltage increases above this limit, the drive will trip to an F70 Supply voltage fault.

**NOTE!** OPT-D7 is not used for detection.

Use this function for the final protection function for the grid or the generator. Delay to trip is 150 ms. The protection group has functions that use OPT-D7 for voltage level protection.

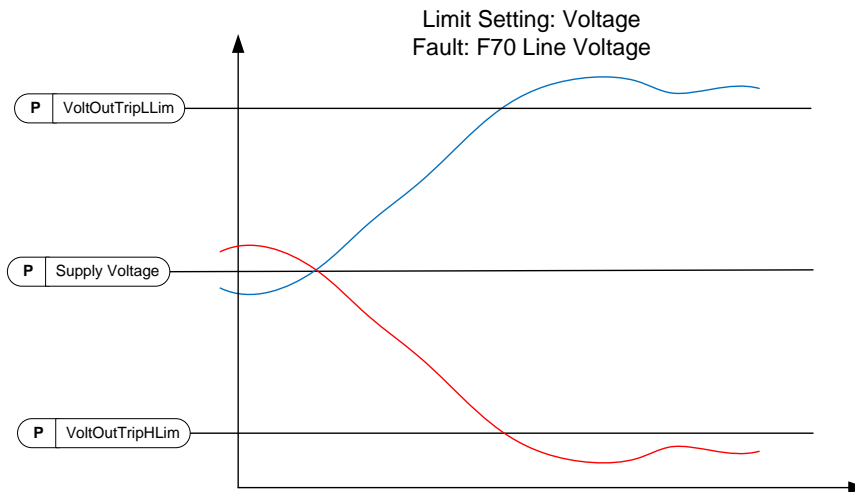

Note: This monitor voltage at drive terminal. When compensating LCL terminal voltage, Output voltage may be considerable higher on full load situations than given Supply Voltage

Note: Low Voltage trip from output voltage is disabled if drive has detected Short Circuit

Figure 4.

### 7.9.9 OVER LOAD PROTECTION

With this function it is possible to select if Current %, Active Current or Reactive Current is used for over load protection. Over Load is based on internal counter that is increased when input value is above 105 % level and decreased when below 105 % level. The increase and decrease occurs every 100 ms.

Tripping is made when over load counter value is over 10 000.

With parameters you can define the increase (Over load maximum step) at maximum defined input level (Over Load Maximum Input). These points define the slope for the function. For example, if the input value is in the middle of 105 % and Over Load Maximum Input values, the counter is increased by a half of the Over Load Maximum step.

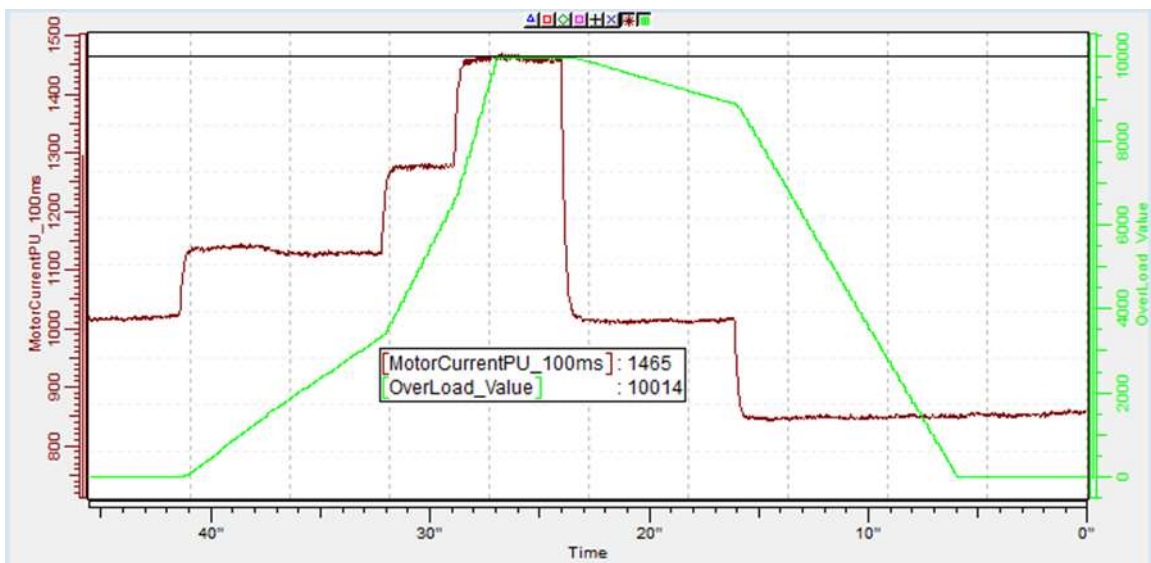

Figure 5.

#### 2.9.9.1 Response to over load ID1838 "OverLoadResponse"

- 0 = No response
- 1 = Warning
- 2 = Fault

#### 2.9.9.2 Over Load Signal ID1837 "OverLoadSignal"

- 0 = Not Used
- 1 = Total Current [%] (FW: MotorCurrentPU\_100ms)
- 2 = Active Current
- 3 = Reactive Current

#### 2.9.9.3 Over Load Maximum Input ID1839 "OverLoadMaxIN"

Input value level where the over load counter is increased with maximum step defined by P2.9.9.4

**2.9.9.4**    *Over Load Maximum Step*    *ID1840*    *"OverLoadMaxStep"*

Step in the over load counter when the input value is at maximum input level defined by P2.9.9.3.

**7.9.10**    **D7 PROTECTIONS**

**2.9.10.1**    *THD Response*    *ID 1672*

Use this parameter to select the response for the total harmonic distortion protection of the OPT-D7 option board.

0 = No response

1 = Warning

2 = Fault

**2.9.10.2**    *THD Warning Limit*    *ID 1673*

When the total harmonic distortion measured in the voltage measured by the OPT-D7 board exceeds this limit, the drive can issue a warning.

**2.9.10.3**    *THD Fault Limit*    *ID 1674*

When the total harmonic distortion measured in the voltage measured by the OPT-D7 board exceeds this limit, the drive can issue a fault.

**2.9.10.4**    *HF RMS Response*    *ID 1675*

Use this parameter to select the response for the high frequency root-mean-square protection of the OPT-D7 option board.

0 = No response

1 = Warning

2 = Fault

**2.9.10.5**    *HF RMS Warning Limit*    *ID 1676*

When the high frequency root-mean-square voltage measured by the OPT-D7 board exceeds this limit, the drive can issue a warning.

**2.9.10.6**    *HF RMS Fault Limit*    *ID 1677*

When the high frequency root-mean-square voltage measured by the OPT-D7 board exceeds this limit, the drive can issue a fault.

**7.9.11 COOLING PROTECTION**

Protection for liquid cooled units. An external sensor is connected to the drive (DI: Cooling Monitor) to indicate if cooling liquid is circulating.

***P2.9.11.1 Cooling fault delay ID751 "Cooling F Delay"***

This parameter defines the delay after which the drive goes to fault state when 'Cooling OK' signal is missing.

***P2.9.11.2 Cooling fault response ID762 "CoolingFaultREsp"***

In some cases it is more important to allow the drive to run even if the cooling liquid is not circulating. Then it is possible to select warning as the response. The drive will then continue running until its internal protection will stop it. If cooling signal loss happens on stop state indication is not stored to fault history if previous fault is already Cooling Fault. In Run State indication is always stored to fault history

0 = Stop State: No Action, Run State: Warning

1 = Stop State: Warning, Run State: Warning

2 = Stop State: Warning, Run State: Fault

3 = Stop State: No Action, Run State: Fault

**7.9.12 EXTRA*****2.9.11 Fault Simulation ID1569 "Fault Simulation"***

With this parameter it is possible to simulate different faults without actually making, for example, an over current situation. In the point of view of the drive interface, the operation is identical to actual fault situation.

B00 = +1 = Simulates an over current fault (F1)

B01 = +2 = Simulates an over voltage fault (F2)

B02 = +4 = Simulates an under voltage fault (F9)

B03 = +8 = Simulates an output phase supervision fault (F11)

B04 = +16 = Simulates an earth fault (F3)

B05 = +32 = Simulates a system fault (F8)

**This fault simulation covers a wide range of different faults in drive. See the fault description for details.**

B06 = +64 = Free

B07 = +128 = Simulates an over temperature warning (W14)

B08 = +256 = Simulates an over temperature fault (F14)

**The warning bit must be active for a fault to appear in simulation. If the fault bit is left active, the drive will go FAULT state at warning limit when the drive temperature rises to the warning level.**

B09 = +512 = Reserved

***2.9.11 Reset Datalogger ID1857***

**0 = Auto**

Datalogger signals will be changed based on control mode automatically. Setting datalogger from NCDrive will disable signal change automatically, to reactivate automatic change set this parameter to 1.

**1 = Reset to Auto**

When datalogger signals have been changed in NCDrive use this to set datalogger back to Auto mode.

**2 = SW Default**

System software defaults are activated and mode changes automatically to 4.

**3 = Auto Fast**

Same as selection 0 but signals are recorded at fast time level. This selection will increase system load.

**4 = No Change**

Application will not make changes to signal.



**7.10 FIELDBUS**

See communication structure from corresponding fieldbus manual. Below examples from Profibus and Modbus.

**Note:** Fieldbus Control word is fixed and can't be parametrized. Selecting here ID write to ID1160 will cause double writing to Control Word and drive failure to follow fieldbus commands.

PRIFIBUS													
Parameter Field				Process Data Field									
ID	IND	Value		CW	Ref	PD1	PD2	PD3	PD4	PD5	PD6	PD7	PD8
				SW	Act	PD1	PD2	PD3	PD4	PD5	PD6	PD7	PD8
PPO1													
PPO2													
PPO3													
PPO4													
PPO5													

Modbus											
Process Data Field											
	CW	GCW	Ref	PD1	PD2	PD3	PD4	PD5	PD6	PD7	PD8
ID	SW	GSW	Act	PD1	PD2	PD3	PD4	PD5	PD6	PD7	PD8
ID	2101	2102	2103	2104	2105	2106	2107	2108	2109	2110	2111
ID	2001	2002	2003	2004	2005	2006	2007	2008	2009	2010	2011

- Byte
- ID Parameter type and number
- IND Parameter subindex
- Value Parameter vaue
- CW Control Word
- SW Status Word
- GCW General Control word
- GSW General Status wod
- Ref Reference Value 1
- ACT Actual Value 1
- PD Process Data

**2.10.1 FB Actual Value Sel ID 1853**

Enter the ID of the parameter you wish to use as the Fieldbus Actual -control variable.

**2.10.2 to**

**2.10.9 FB Data Out 1-8 Sel ID 852-859**

Using these parameters, you can monitor any monitoring or parameter value from the fieldbus. Enter the ID number of the item you wish to monitor as the value of these parameters

**2.10.10 to**

**2.10.17 FB Data Out 9-16 Sel ID 558-565**

These parameters are the same as parameters *P2.10.2-9*, but they are only available if a fieldbus board with hardware and software support for 16 process data variables is inserted in option board slot D or E.

*2.10.18 to**2.10.25 FB Data In 1-8 Sel ID 876-883*

Using these parameters, you can control any parameter value from the fieldbus. Enter the ID number of the item you wish to control as the value of these parameters.

*2.10.26 to**2.10.33 FB Data In 9-16 Sel ID 550-557*

These parameters are the same as parameters *P2.10.18-25*, but they are only available if a fieldbus board with hardware and software support for 16 process data variables is inserted in option board slot D or E.

*2.10.34 GSW Data ID 897*

With this parameter it is possible to select which data is sent in FBGeneralStatusWord.

**2.10.35 State Machine ID 896**

The application provides a possibility to select what kind of state machine is used.

**0: Basic**

This mode makes fieldbus control behave as is explained in the fieldbus board manual.

**1: Standard**

A simple control word that is used in modes where the control word from fieldbus is used as such. For some fieldbus boards this requires a bypass operation.

**2: Vacon AFE 1**

This mode uses a ProfiDrive type state machine in the application level. You can use this mode on fieldbus boards that do not have a state machine or have a possibility to bypass the state machine function in the option board.

**3: Vacon AFE 2**

This mode uses a ProfiDrive type state machine in the application level. You can use this mode on fieldbus boards that do not have a state machine or have a possibility to bypass the state machine function in the option board. More extensive control than Vacon AFE 1 state machine selection.

**2.10.36 Control Slot selector ID 1440**

This parameter defines which slot is used as the main control place when fieldbus boards have been inserted into the drive. When values 8-9 are selected the drive can use the Extended fieldbus mode if a fieldbus board with support for that mode is inserted in slot D or E. For more information refer to the fieldbus board manual.

**0** = No Sel. Control signals are monitored from every fieldbus board.

**4** = Slot D Control signals are monitored from Slot D (8 process data variables).

**5** = Slot E Control signals are monitored from Slot E. (8 process data variables).

**8** = Slot D with Extended fieldbus mode (16 process data variables).

**9** = Slot E with Extended fieldbus mode (16 process data variables).

**2.10.37 SW ID.Bit selection B11 ID 1907****2.10.38 SW ID.Bit selection B12 ID 1908****2.10.39 SW ID.Bit selection B13 ID 1909****2.10.40 SW ID.Bit selection B14 ID 1910**

Select the bit that used in FB Status Word Bit 11, 12, 13 and 14.

**2.10.41 uGrid CW B12 parameter ID 1934 "uCW B12"****2.10.42 uGrid CW B13 parameter ID 1935 "uCW B13"****2.10.43 uGrid CW B14 parameter ID 1936 "uCW B14"****2.10.44 uGrid CW B15 parameter ID 2937 "uCW B15"**

With these parameters you can define the parameter to be controlled by using Micro Grid Control Word bits 12-15.

## 7.11 MICRO GRID (UGRID)

### 2.11.1 Control Mode ID1531

Select the AFE operation mode.

#### 0 = AFE

Standard AFE functionality, no license key required. Keeps fixed DC-Link Voltage.

#### 1 = Island

Island operation mode, cannot operate parallel with other power sources. Makes fixed voltage and frequency, i.e. no voltage or frequency drooping. Also low DC-Link Voltage limitation function is disabled. Reacts only to set DC Under Voltage limit.

#### 2 = uGrid

uGrid operation mode, can operate parallel with other power sources. Parallel operation is achieved by voltage and frequency drooping.

Control starts to reduce output frequency if there is not enough DC-Link Voltage, this will prevent reactive current generation between different power sources on the grid in case of low power in grid converter DC-Link.

#### 3 = Island - AFE

The drive changes the control mode automatically when feedback from the external net contactor has been received.

#### 4 = Island - uGrid

The drive changes the control mode automatically when feedback from the external net contactor has been received.

#### 5 = uGrid – AFE

The drive changes the control mode automatically when feedback from the external net contactor has been received.

#### 6 = Free Select

The operation mode is selected by digital inputs and AFE mode 1-3 selections.

**NOTE!** A licence is necessary for other than the standard AFE mode.

2.11.2 Frequency Droop ID1534

Drooping related to the active current in Hz. Set to the same value as all other power sources drooping. Used in uGrid operation mode.

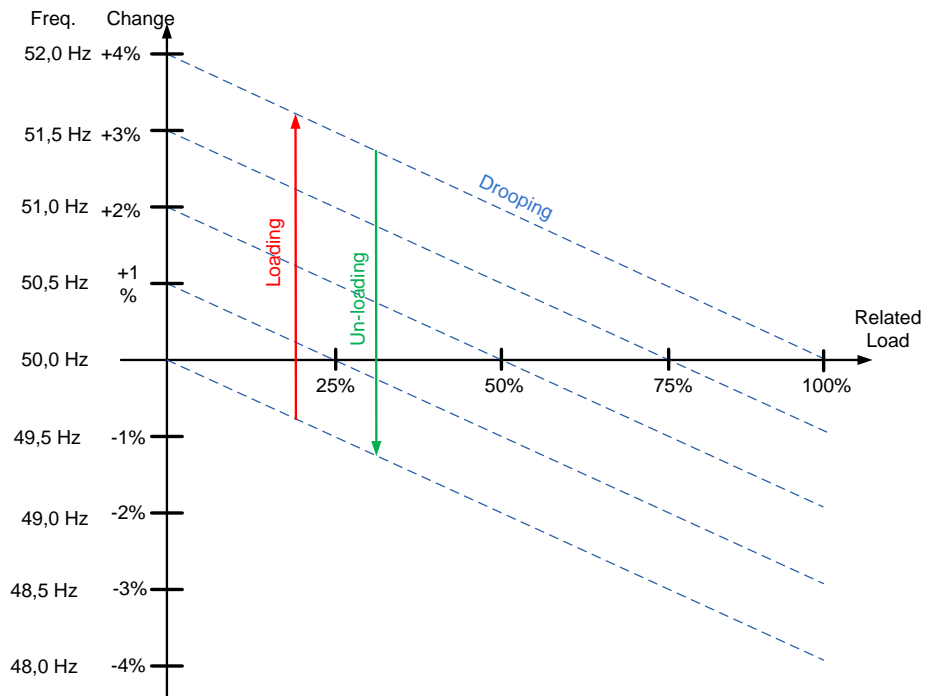

Figure 6.

2.11.3 Voltage Droop ID1535

This parameter defines the voltage droop at 100% reactive current. The reactive current drooping in percentage of P2.1.1. Used in uGrid operation mode.

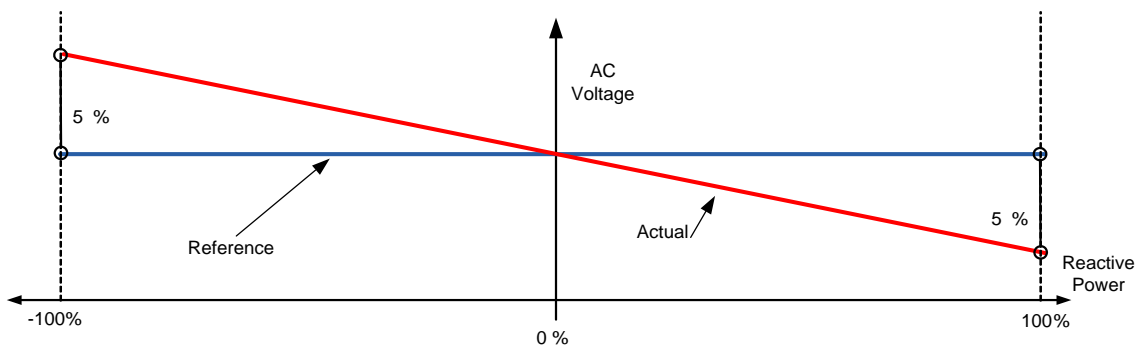

Figure 7.

#### 2.11.4 *Start Power Mode*

Defines what is used as frequency reference when grid converter starts in uGrid mode.

##### **0 = Zero Power OPT-D7**

In this mode drive will start at zero power by setting internal frequency reference same as is the grid frequency measured from OPT-D7 board. After the start operation is normal Drooping mode.

##### **1 = Zero Power from Supply Frequency**

This selection is only possible with unit F19 and bigger with AFE Options 1 B9.

In this mode drive will start at zero power by setting internal frequency reference same as is the grid frequency measured from drive terminals. After the start operation is normal Drooping mode.

##### **2 = Drooping**

The drive goes directly to the drooping control with set frequency references. 3 = Isochron Generator

##### **3 = Isochron Generator**

The drive will follow the line frequency exactly using OPT-D7 option board measurements, so that grid frequency change will not change the power in this operation mode. In this mode, power is controlled by the Base Current Reference (ID1533). Frequency reference from OPT-D7 is still limited by Grid Frequency warning limits in protection group (ID1780 and ID1783) and when reaching these limits operation behaviour is like in normal Drooping mode. In case wide frequency range see also OPT-D7 OK limits in G2.16.5

#### 2.11.5 *Voltage Rise Time*      *ID1541*

This parameter defines the time until the voltage is at nominal when the drive is started in Island mode or when in Micro Grid mode without an existing grid. Voltage Rise Time is used to minimize inrush current e.g. when Grid Converter needs to magnetize transformer on start.

### 7.11.1 GENERATOR SIMULATION

These parameters are used to make drive operate more like diesel generator set.

#### P2.11.6 Generator Mechanical Time Constant ID1722

Simulated diesel generator mechanical time constant.

Values above zero will enable diesel generator simulation function. Use 1000 ms as a starting point if actual mechanical time constant is not known.

#### P2.11.7 Generator Speed Control Kp ID1723

Simulated diesel generator speed control gain.

#### P2.11.8 Generator Speed Control Ti ID1724

Simulated diesel generator speed control Ti.

### 7.11.2 AFE OPERATION MODE SELECTION

When using digital input P2.4.2.17 AFE Mode 2 and P2.4.2.18 AFE Mode 3 with the parameters below, it is possible to select the operation independently for both the digital inputs.

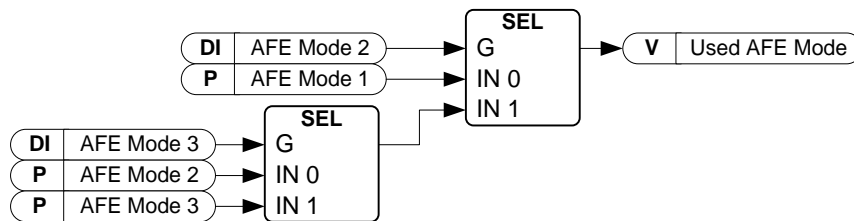

Figure 8.

#### 2.11.10.1 AFE Mode 1

Only active when P2.11.1 is 6/Free select.

0= AFE

1= Island

2= Micro Grid

#### 2.11.10.2 AFE Mode 2

Only active when P2.11.1 is 6/Free select.

0= AFE

1= Island

2= Micro Grid

#### 2.11.10.3 AFE Mode 3

Only active when P2.11.1 is 6/Free select.

0= AFE

1= Island

2= Micro Grid

**7.12 SYNCH TO EXTERNAL GRID**

This function is used to synchronise to an external grid. Measurements with OPT-D7 are necessary for the use of this function. When there are parallel unit's synchronization needs to be done by upper system. e.g. by controlling Frequency Up and Down commands to all units (and other power sources in the same grid).

NET breaker can be closed in stop state when P2.7.8 Control Options ID1707 B6 (+64) is activated.

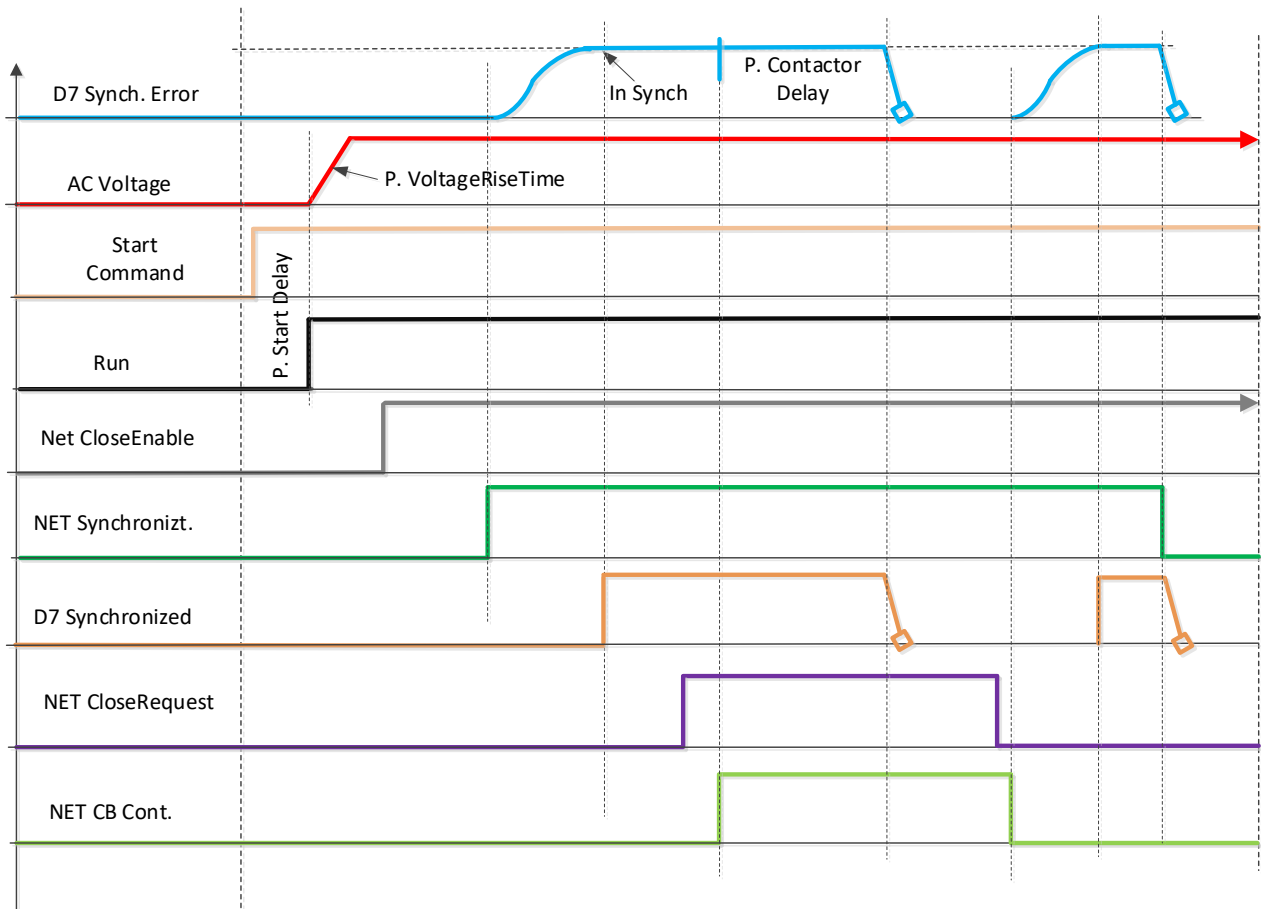
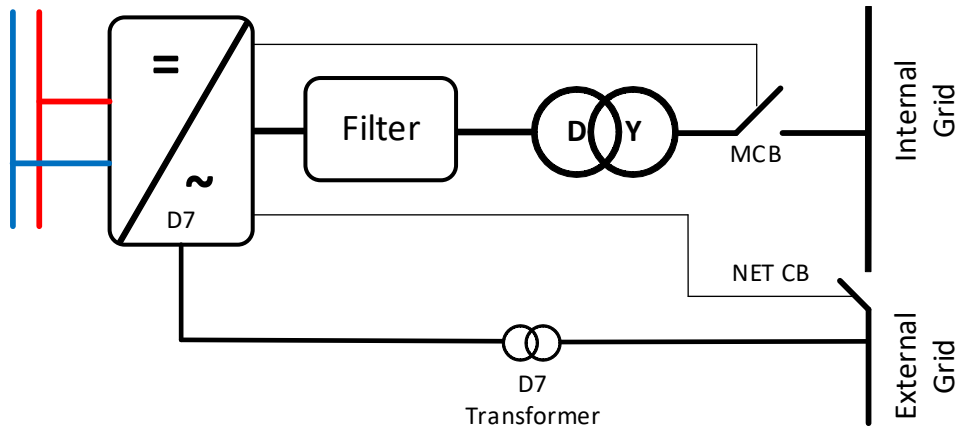

**NXP00002V205 and newer**

Synch. Offset (ID1601) and Synch Reference (ID1611) can be left to zero. Monitoring variable "D7 Synch. Error" is compensated from P2.1.11 Transformer Phase Shift ID1852.



**2.12.1 Synch. Offset ID1601**

NOTE: Leave zero with NXP00002V205 and newer, see above.

Used to compensate angle offset between the drive output terminals and OPT-D7 measurement point. E.g. with Dyn11, the transformer angle offset is usually 30.0 degree. This equals as 512 for this parameter. (3072 equals 180 degrees offset). If possible, run in AFE mode and see monitoring variable "D7 Synch. Error" to see what is needed for the offset.

$$\frac{x \text{ degree} * 3071}{180 \text{ degree}} = \text{Synch. Offset}$$

**2.12.2 Synch Reference ID1611**

NOTE: Leave zero with NXP00002V205 and newer, see above.

Use of P:Synch. Offset do not affect the error value that is shown in monitoring variable "D7 Synch. Error". Therefore you must give the reference for synchronization; usually this reference is roughly the same as P:"Synch. Offset" value, depending on the system. (3072 equals 180 degrees offset).

**2.12.3 Synch Kp ID1612**

Island mode line sync gain. Init = 500.

**2.12.4 Synch Ti ID1613**

Reserved (not in use)

**2.12.5 Synch.Hysteresis ID1614**

Window for closing the net circuit breaker. (3172 equals 180 degrees).

**2.12.6 Synch Stop Mode ID1618**

Select operation after the drive has synchronised and received feedback from the shore contactor.

0 = Stay Run

1 = Stop

**P2.12.7 NET Close Delay ID1624**

This parameter defines delay when operation mode is changed to AFE mode when e.g. P2.11.1 Control Mode ID1531 is 5 / uGrid – AFE. When drive gives control signal to NET breaker to close. If set to zero drive will use solely NET Breaker feedback. Feedback is also used when delay parameter is active, whichever comes first will change the mode.

**P2.12.8 NET Open Delay ID1634**

If P2.12.7 NET Close Delay ID1624 is zero this parameter has no affect.

This parameter defines delay when operation mode is changed to uGrid mode when e.g. P2.11.1 Control Mode ID1531 is 5 / uGrid – AFE when drive removed control signal to NET breaker to open it. Feedback is also used when delay parameter is active, for the operation mode to change, delay needs to be passed and the feedback from the breaker needs to be low.

### 7.13 ID FUNCTIONS

Here you will find the functions that use the parameter ID number to control and monitor the signal.

#### 7.13.1 VALUE CONTROL

The value control parameters are used to control an input signal parameter.

##### *P2.14.1.1 Control Input Signal ID ID1580 "ContrInSignal ID"*

With this parameter you can select which signal is used to control the selected parameter.

##### *P2.14.1.2 Control Off Limit ID1581 "Contrl Off Limit"*

This parameter defines the limit when the selected parameter value is forced to Off value.

##### *P2.14.1.3 Control On Limit ID1582 "Contrl On Limit"*

This parameter defines the limit when the selected parameter value is forced to On value.

##### *P2.14.1.4 Control Off Value ID1583 "Contrl Off Value"*

This parameter defines the value that is used when the used input signal is below Off limit.

##### *P2.14.1.5 Control On Value ID1584 "Contrl On Value"*

This parameter defines the value that is used when the used input signal is above On limit.

##### *P2.14.1.6 Control Output Signal ID ID1585 "ContrlOutSignID"*

This parameter defines which parameter is forced to On and Off values when selected input signal exceeds the set limits.

##### *P2.14.1.7 Control Mode ID1586 "Control Mode"*

This parameter defines how the value control output behaves.

0 = SR ABS

Absolute input value is used to make a step change in the output between On and Off values.

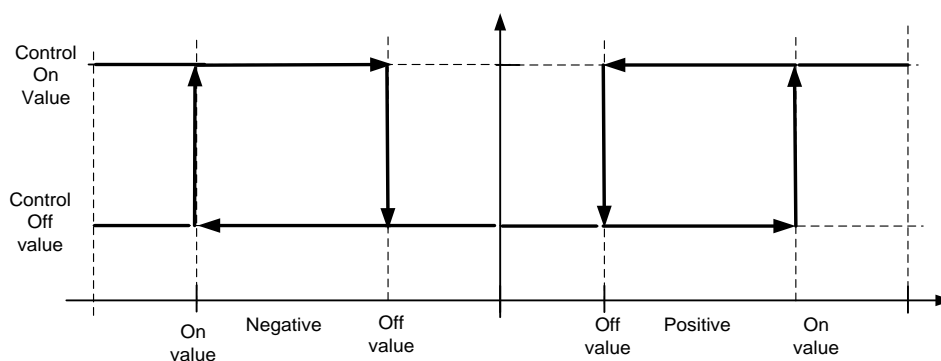

Figure 9.

**1 = Scale ABS**

Absolute input value is scaled linearly between On and Off values.

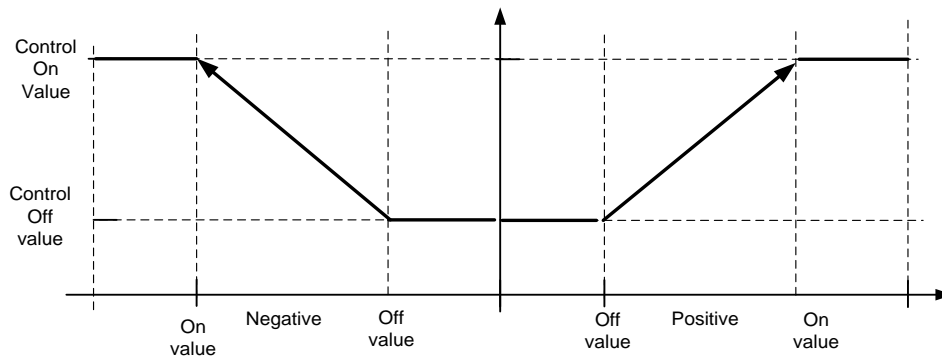

Figure 10.

**2 = Scale ABS Inverted**

Inverted absolute value is scaled linearly between On and Off values.

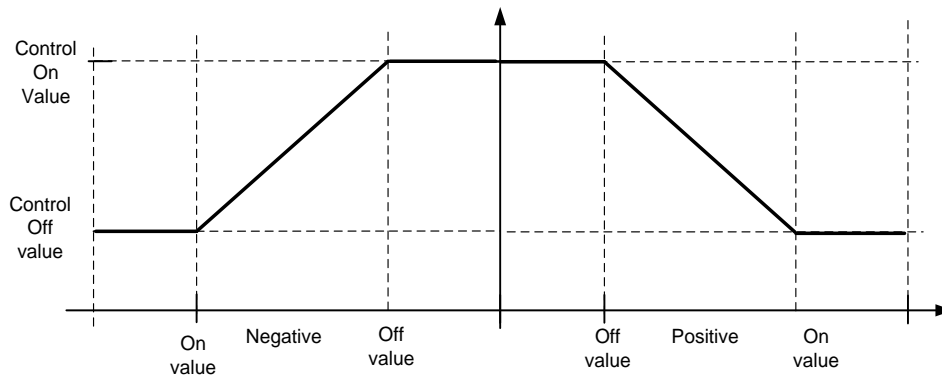

Figure 11.

**3 = SR**

Input value is used to make a step change in the output between On and Off values.

**4 = Scale ABS**

Input values is scaled linearly between On and Off values.

**5 = Scale Inverted**

Inverted value is scaled linearly between On and Off values

**P2.14.1.8 Control Signal Filtering TC ID1586 "Control Filt TC"**

This parameter is used to filter the scaling function output. This can be used, for example, when unfiltered torque is used to control a parameter that needs stabilisation.

### 7.13.1.1 XY-Plot

With this function is possible to make own curve. e.g. selecting DC-Link voltage and make the points to control Current reference based on DC-Link voltage level. X-Values are input values and Y-values are outputs.

<i>P 2.14.1.9.1</i>	<i>X Value 01</i>	<i>3801</i>
<i>P 2.14.1.9.2</i>	<i>Y Value 01</i>	<i>3813</i>
<i>P 2.14.1.9.3</i>	<i>X Value 02</i>	<i>3802</i>
<i>P 2.14.1.9.4</i>	<i>Y Value 02</i>	<i>3814</i>
<i>P 2.14.1.9.5</i>	<i>X Value 03</i>	<i>3803</i>
<i>P 2.14.1.9.6</i>	<i>Y Value 03</i>	<i>3815</i>
<i>P 2.14.1.9.7</i>	<i>X Value 04</i>	<i>3804</i>
<i>P 2.14.1.9.8</i>	<i>Y Value 04</i>	<i>3816</i>
<i>P 2.14.1.9.9</i>	<i>X Value 05</i>	<i>3805</i>
<i>P 2.14.1.9.10</i>	<i>Y Value 05</i>	<i>3817</i>
<i>P 2.14.1.9.11</i>	<i>X Value 06</i>	<i>3806</i>
<i>P 2.14.1.9.12</i>	<i>Y Value 06</i>	<i>3818</i>
<i>P 2.14.1.9.13</i>	<i>X Value 07</i>	<i>3807</i>
<i>P 2.14.1.9.14</i>	<i>Y Value 07</i>	<i>3819</i>
<i>P 2.14.1.9.15</i>	<i>X Value 08</i>	<i>3808</i>
<i>P 2.14.1.9.16</i>	<i>Y Value 08</i>	<i>3820</i>
<i>P 2.14.1.9.17</i>	<i>X Value 09</i>	<i>3809</i>
<i>P 2.14.1.9.18</i>	<i>Y Value 09</i>	<i>3821</i>
<i>P 2.14.1.9.19</i>	<i>X Value 10</i>	<i>3810</i>
<i>P 2.14.1.9.20</i>	<i>Y Value 10</i>	<i>3822</i>
<i>P 2.14.1.9.21</i>	<i>Y Value 11</i>	<i>3823</i>
<i>P 2.14.1.9.22</i>	<i>X Value 11</i>	<i>3811</i>
<i>P 2.14.1.9.23</i>	<i>X Value 12</i>	<i>3812</i>
<i>P 2.14.1.9.24</i>	<i>Y Value 12</i>	<i>3824</i>

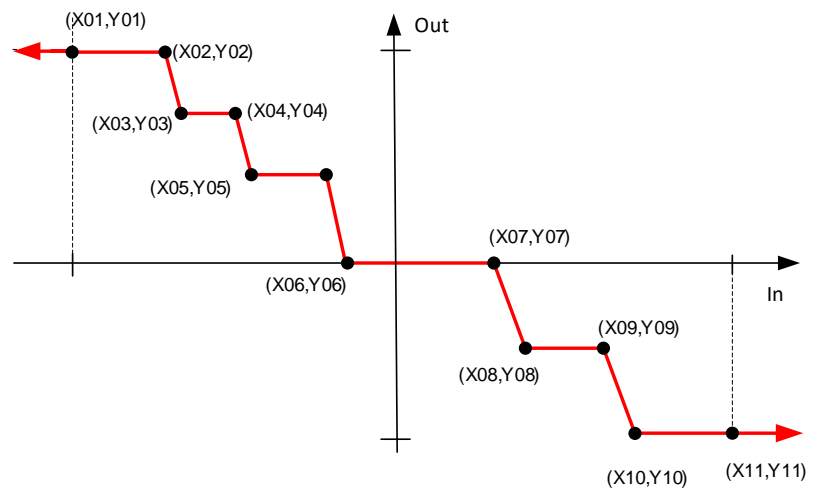

### 7.13.2 DIN ID CONTROL

This function is used to control any parameter between two different values with a digital input. Different values are given for DI LOW and DI HIGH.

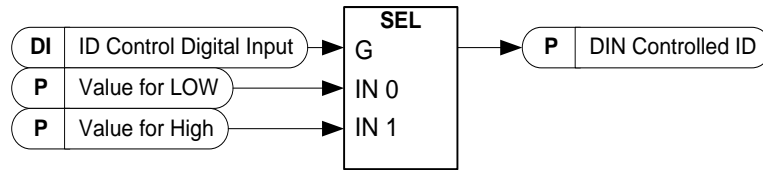

Figure 12.

*P2.14.2.1 ID Control Digital Input ID1570 "ID Control DIN"*

*P2.14.3.1 ID Control Digital Input ID1590 "ID Control DIN"*

*P2.14.4.1 ID Control Digital Input ID1578 "ID Control DIN"*

Select a digital input to be used for controlling the parameter selected by ID1571.

*P2.14.2.2 DIN Controlled ID ID1571 "Controlled ID"*

*P2.14.3.2 DIN Controlled ID ID1575 "Controlled ID"*

*P2.14.4.2 DIN Controlled ID ID15719 "Controlled ID"*

Select a parameter ID controlled by ID1570.

*P2.14.2.3 Value for Low digital input (FALSE) ID1572 "FALSE Value"*

*P2.14.3.3 Value for Low digital input (FALSE) ID1592 "FALSE Value"*

*P2.14.4.3 Value for Low digital input (FALSE) ID15794 "FALSE Value"*

Set the controlled parameter value when the digital input (ID1570) is LOW for the parameter selected by ID1571. The function does not recognise decimals. For example, give the value 10.00 Hz as *1000*.

*P2.14.2.4 Value for High digital Input (TRUE) ID1573 "TRUE Value"*

*P2.14.3.4 Value for High digital input (TRUE) ID1593 "TRUE Value"*

*P2.14.4.4 Value for High digital input (TRUE) ID1596 "TRUE Value"*

Set the controlled parameter value when the digital input (ID1570) is HIGH for the parameter selected by ID1571. The function does not recognise decimals. For example, give the value 10.00 Hz as *1000*.

### 7.13.3 ID CONTROLLED DIGITAL OUTPUT

This function is used to control any Digital output by any status that can be presented as bit. The input signal is selected with the ID number and bit number.

**Example:** Most of the faults and warnings are normally presented in the common digital output. With the ID-controlled DO function, it is possible to select a specific fault to be connected to the digital output.

Warning Word 1 ID1174		
	Fault	Comment
b0	Motor stalled	W15
b1	Motor over temperature	W16
b2	Motor underload	W17
b3	Input phase loss	W10
b4	Output phase loss	W11
b5	Safe disable	W30 (Not implemented)
b6	FieldBus communication fault in slot D	W53 (Not implemented)
b7	FieldBus communication fault in slot E	W67 (Not implemented)
b8	Drive over temperature	W14
b9	Analogue input < 4mA	W50
b10	Not used	
b11	Emergency stop	W63 (Not implemented)
b12	Run disabled	W62 (Not implemented)
b13	Not used	
b14	Mechanical Brake	W58
b15	Not used	

**P2.14.6.1 ID.Bit Free Digital output control 1**    **ID1216**    **"ID.Bit Free D01"**

**P2.14.7.1 ID.Bit Free Digital output control 2**    **ID1386**    **"ID.Bit Free D02"**

Select the signal for controlling the DO. The parameter has to be set in format xxxx.yy where xxxx is the ID number of a signal and yy is the bit number. For example, the value for DO control is *1174.02*. 1174 is the ID number of Warning Word 1. So the digital output is ON when bit number 02 of the warning word (ID no. 1174) i.e. *Motor underload* is high.

**P2.14.6.2 Free Digital Output selector**    **ID1574**    **"Free D01 Sel."**

**P2.14.7.2 Free Digital Output selector**    **ID1325**    **"Free D02 Sel."**

Select the output terminal to be controlled with the parameter ID.bit Free Digital output control.

## 7.14 AUTO FAULT RESET

### P2.15.1 Wait Time ID717

Defines the time for the attempted fault reset after the fault trigger has passed.

Note: In case of external fault, remove the cause of fault on the external device. The wait time count starts only when the cause of fault has been removed.

### P2.15.2 Trial Time ID 718

The Automatic reset function keeps trying to reset the faults appearing during the time set with this parameter. If the number of faults during the trial time exceed the value of the respective parameter set with ID720 to ID725 a permanent fault is generated.

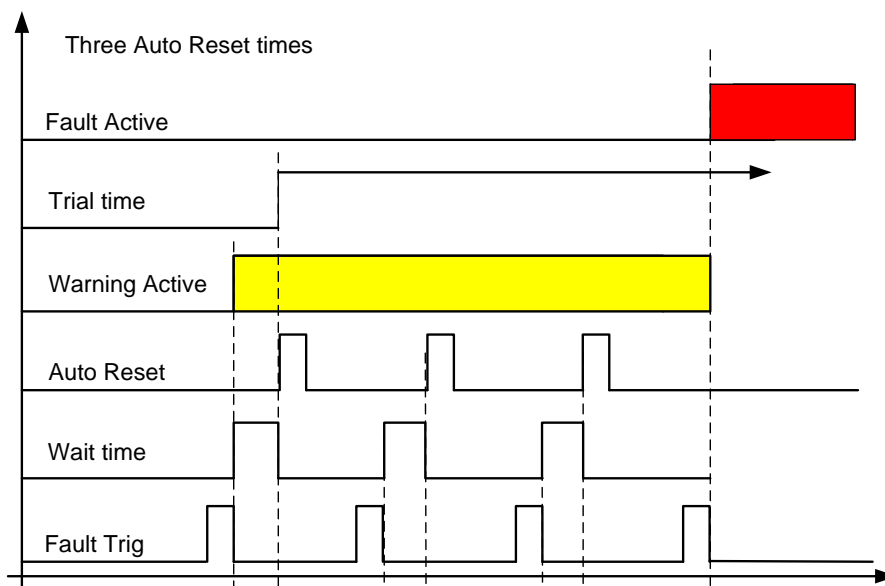

Figure 13. Figure 7-2. Example of Automatic restarts with three restarts

### P2.15.3 Overvoltage Tries ID 721

Use this parameter to define the amount of auto reset tries for an overvoltage fault.

### P2.15.4 Overcurrent Tries ID 722

Use this parameter to define the amount of auto reset tries for an overcurrent fault.

### P2.15.5 External Fault Tries ID 725

Use this parameter to define the amount of auto reset tries for an external fault.

### 7.15 GRID VOLTAGE PI CONTROLLER

The PI controller is meant to help keep the line voltage constant when the load changes in Island mode. The OPT-D7 option board is necessary. The PI controller controls the field weakening voltage point to keep a constant voltage on the line.

In uGrid mode controller is I type controller and considers set Voltage Drooping.

When OPT-D7 board is not used, it is possible to use Analogue Input 3 and 4 ID write function to give the grid the Line Frequency D7 (ID1654) and Line Voltage D7 (ID1650). This enables use of grid PI voltage controller without the OPT-D7 board. Note that both line frequency and line voltages needs to be given. When Line Voltage is given without OPT-D7 board this mode can be used only in Island mode.

**NOTE:** Activating this function will disable Start Voltage Mode function Keep Zero Q ID1641.

#### *P2.16.1 PI Activation ID1807*

Select the digital input that will activate the PI controller. Set selection to 0.2 and the PI controller is activated without an external wiring.

#### *P2.16.2 PI Controller Gain ID118*

This parameter defines the gain of the PID controller. If the value of the parameter is set to 100%, a change of 10% in the error value causes the controller output to change by 10%. If the parameter value is set to 0, the PID controller operates as an I controller.

#### *P2.16.3 PI Controller I-time ID119*

The parameter ID119 defines the integration time of the PID controller. If this parameter is set to 1.00 second, a change of 10% in the error value causes the controller output to change by 10.00%/s. If the parameter value is set to 0.00 s, the PID controller will operate as a P controller.

#### *P2.16.4 PI Max Adjust ID360*

This parameter defines maximum adjustment that PI controller can made to voltage.



### 7.15.1 GRID VOLTAGE PI OPT-D7 LIMITS

These parameters define the limits within which the OPT-D7 measurements must remain in order for the PI controller to remain active. This is a protection function in case of a measurement loss. When a measurement loss is detected, the drive will not stop, but instead it continues to operate by using open loop voltage compensation (Inductor Size and Losses).

**Compatibility note:**

Since version V132 these limits affect the Measurement OK signal (V1.3.7 FB Micro Grid SW1 ID1701) bit 14. Thus, all OPT-D7 related functions fail to fail safe or stop working in case grid frequency or voltage exceeds these limits, e.g. voltage Compensation, isochronous mode,

*P2.16.5.1 PI Frequency Low Limit            ID1630*

*P2.16.5.2 PI Frequency High Limit        ID1631*

*P2.16.5.3 PI Voltage Low Limit            ID1632*

*P2.16.5.4 PI Voltage High Limit          ID1633*

### 7.16 GRID CODE PARAMETERS

Grid Codes cannot be used or activated without correctly connected OPT-D7 board.  
Grid Code functionality is only available when drive is operating in AFE mode.

Frequency and voltage percentage values are in relation to P2.1.2 Grid Nominal Frequency ID1532 and P2.1.1 Grid Nominal Voltage ID110. 100 % = nominal.

**NOTE!** Drive Grid Codes are compliant only when drive itself is controlling the MCB.

#### *P 2.17.1 GGC License* *ID3201*

Enter here license code to enable Grid Code functionality.

#### *P 2.17.2 Set Grid Code* *ID3401*

Load Grid Code setting

1 = Factory Defaults for grid codes.

#### *P 2.17.3 Enable Grid Code* *ID3254*      *"EnableGridCode"*

Parameter to activate Grid Code. Grid Code license required for activation except FR4 unit size.

#### **0 = Disabled**

Grid Code functions are disabled.

#### **1 = Enabled, uGrid monitor**

Grid codes are enabled and monitors grid state also in island and uGrid modes.

#### **2 = Enabled**

**Select this mode when Grid Codes are needed**

Grid Code functions are active, drive will stop modulating and opens the MCB in case of Grid Code trip.

#### **3 = Simulation for demo case**

**Development testing mode**

Grid Code enabled in Island and uGrid mode. Note. This is only for testing purposes. e.g. tripping limits. e.g. reactive current or reactive power do not follow Grid Code settings. This mode do not use OPT-D7 but Supply Frequency and Supply Voltage for Grid Code functions.

### 7.16.1 ANTI-ISLANDING

Anti-Islanding function purpose is to disconnect drive from the remaining grid in case connection to main utility grid is lost. This will remove voltage to island side of the grid e.g. if this part of the grid is disconnected from public grid for maintenance purposes.

Anti-Islanding function makes small disturbances to grid, this is not noticeable during normal operation but when there is islanding situation frequency and voltage will not be stable.

Here you can select tripping limit for Anti-islanding function that are separated than normal frequency and voltage tripping limits. Its recommended to select values outside the normal tripping limits.

Internally software is monitoring if e.g. FRT is active and during this time anti-islanding is disabled. Additionally below limits Anti-Islanding is also detected from Line Frequency Change Rate, for reliable operation set P2.17.8.14 LF MaxChangeRate to 2,50 Hz/s.

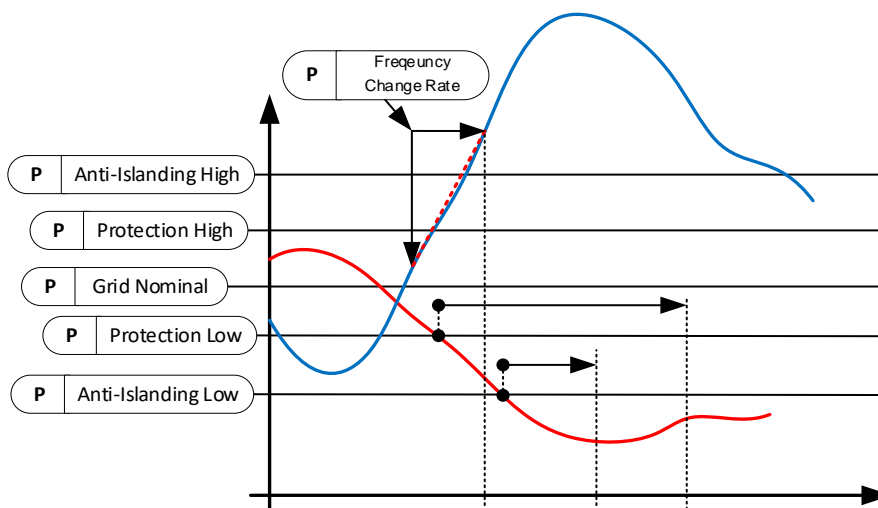

#### P2.17.4.1 Anti-Islanding

ID3250

Enables or disables anti-islanding function.

0 = Disabled

In islanding situation frequency may stay inside acceptable operation.

1 = Active

In islanding situation frequency will change rapidly and frequency limit will trip the drive. Anti-Islanding function is activated 500 ms after drive goes to Run state.

#### P2.17.4.2 Line Frequency maximum change rate Hz/s ID3322 "LF MaxChangeRate"

Tripping if line frequency has changed more than set value inside one (1) second.

*P2.17.4.3 High Volt AI % ID3404*

High Voltage tripping limit for Anti-Islanding function.

*P2.17.4.4 Low Volt AI % ID3405*

Low Voltage tripping limit for Anti-Islanding function.

*P2.17.4.5 High Freq AI % ID3406*

High Frequency tripping limit for Anti-Islanding function.

*P2.17.4.6 Low Freq AI % ID3407*

Low Frequency tripping limit for Anti-Islanding function.

*P2.17.4.7 Anti-Islanding Trip Delay ID3408 "AI Trip Delay"*

Delay for Anti-Islanding function recommended to keep at least 50 ms that software has time to detect e.g. FRT situation.

*P2.17.4.8 Anti-Islanding Kp ID3426*

Gain for anti-islanding. Affects how strongly drive tries to offset own frequency when grid frequency varies from nominal frequency.

### 7.16.2 FRT (FAULT RIDE-THROUGH)

Fault Ride Trough (FRT) function enables AFE drive to remain in run state in case there is deep voltage dip in the grid. Here is also selected is voltage trip limits time used or FRT timer to trip the drive and if reactive current is needed to feed to grid during the FRT.

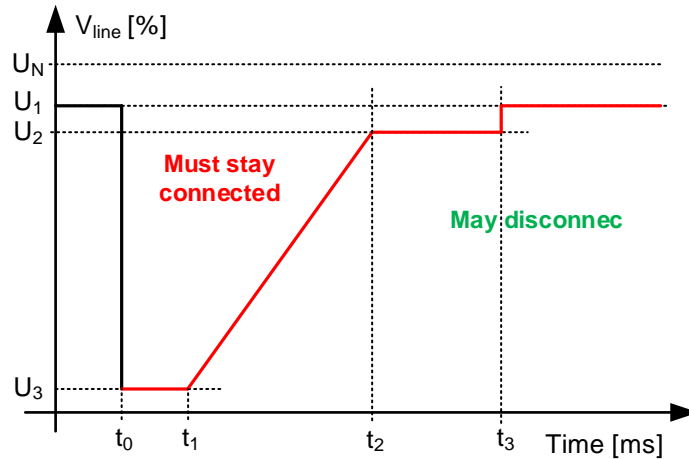

#### P2.17.5.1 FRT Function

ID 3251

Enables FRT functionality.

#### 0 = Disabled; Both

Fault Ride Trough is disabled but voltage level and FRT Timer are active at the same time.

#### 1 = Enabled; Limits

Commonly used selection

Fault Ride Trough is enabled, voltage levels make the trip but not FRT Timer.

#### 2 = Enabled; Curve

Fault Ride Trough is enabled, FRT Timer makes the trip but not voltage levels.

#### 3 = Enabled; Neither

Fault Ride Trough is enabled, but neither FRT Timer or voltage levels are not making trip.

#### 4 = Enabled; Both

Fault Ride Trough is enabled, and voltage level and FRT Timer are active at the same time.

*P2.17.5.2* *ReactiveInjection*                      *ID*    *3252*

Select the grid fault types when reactive current is injected.

**0 = Tri:N, Bi:N**

Reactive current is not injected.

**1 = Tri:Y, Bi:Y**

Reactive current is injected three phase faults and bi-phase faults.

**2 = Tri:Y, Bi:N**

Reactive current is injected to three phase faults but not to bi-phase faults.

*P2.17.5.3* *Symmetrical Reactive*    *ID*    *3323*

Feature compensates small levels of negative sequence current from the inverter output current. This can be useful if line voltages are not symmetrical, and the user wants to have symmetrical output currents under normal operation.

**0 = No**

**1 = Yes**

7.16.2.1 FRT Timer

Define voltage drop curve, drive will trip if curve is exceeded. Timer start when Voltage is below Voltage X6 point. Set X6 as the highest voltage level, X5 the second highest and so on.

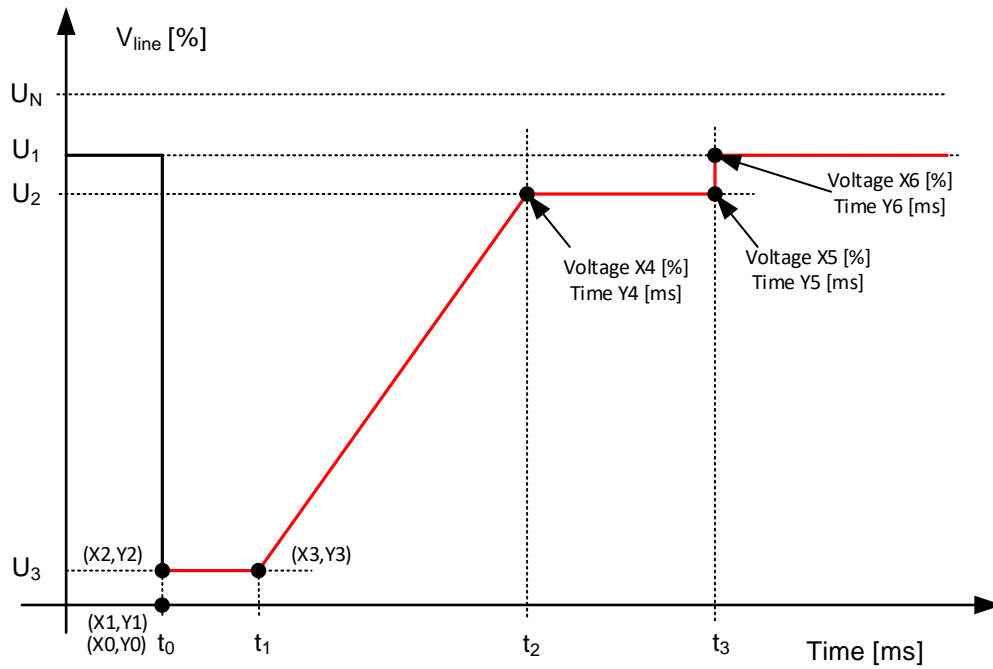

Tripping below red line

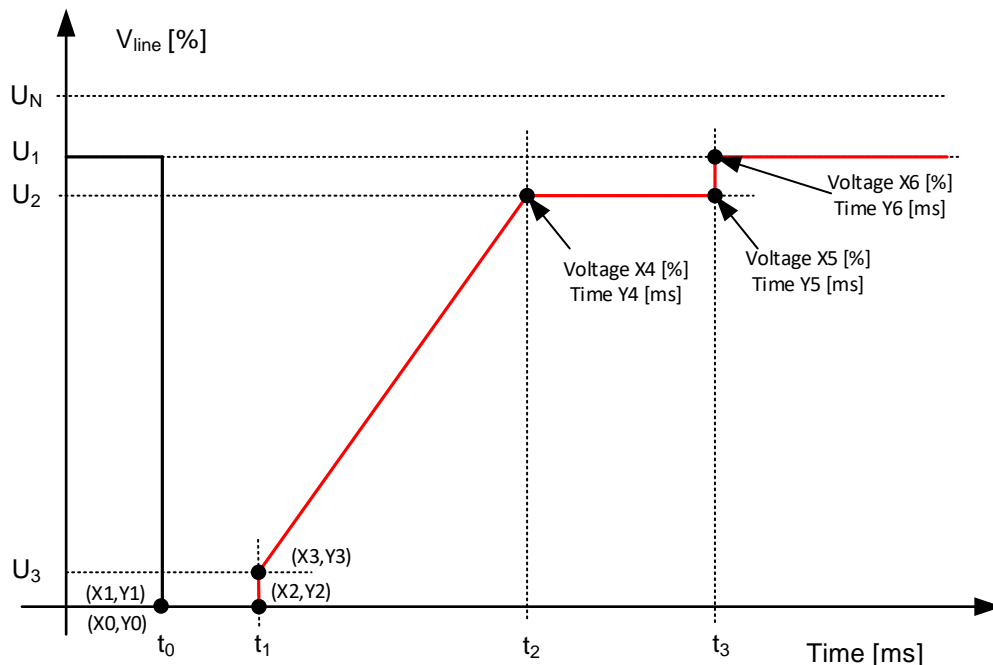

Stays connected at zero voltage between  $t_0$  and  $t_1$

*P 2.17.5.4.1 Voltage X6*                                    %    *ID*    *3284*

Highest voltage level. Below this level timer is started.

*P 2.17.5.4.2 Time Y6*                                    *ms*    *ID*    *3285*

Time to trip when voltage is below X6 point and above X5 point.

Trip time is scaled between X6 and X5 points.

*P 2.17.5.4.3 Voltage X5*                                    %    *ID*    *3282*

*P 2.17.5.4.4 Time Y5*                                    *ms*    *ID*    *3283*

*P 2.17.5.4.5 Voltage X4*                                    %    *ID*    *3280*

*P 2.17.5.4.6 Time Y4*                                    *ms*    *ID*    *3281*

*P 2.17.5.4.7 Voltage X3*                                    %    *ID*    *3278*

*P 2.17.5.4.8 Time Y3*                                    *ms*    *ID*    *3279*

*P 2.17.5.4.9 Voltage X2*                                    %    *ID*    *3276*

*P 2.17.5.4.10 Time Y2*                                    *ms*    *ID*    *3277*

*P 2.17.5.4.11 Voltage X1*                                    %    *ID*    *3274*

*P 2.17.5.4.12 Time Y1*                                    *ms*    *ID*    *3275*

*P 2.17.5.4.13 Voltage X0*                                    %    *ID*    *3272*

Lowest voltage level.

*P 2.17.5.4.14 Time Y0*                                    *ms*    *ID*    *3273*



### 7.16.3 RECONNECTION

These parameters define reconnection behavior after there has been a Grid Code trip. Reconnection time start to count when grid frequency and grid voltage has returned to nominal range.

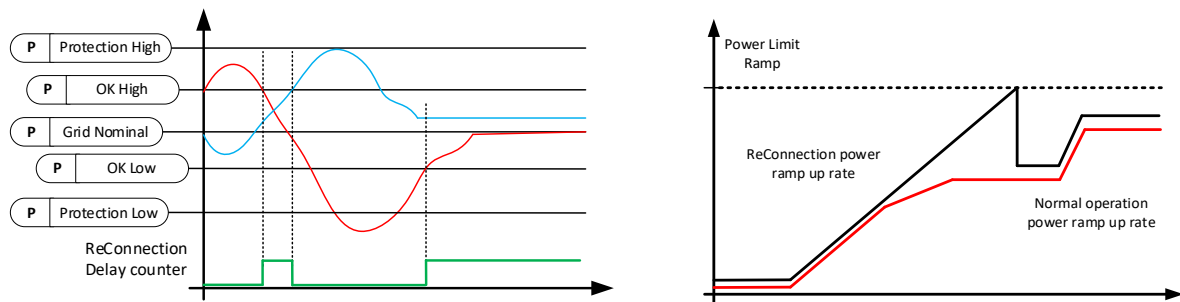

*P 2.17.6.1 ReConnectTime*                    *s*     *ID*     *3253*

Reconnection time when grid code trip has happened on run state.

*P 2.17.6.2 ReConnTimeStop*                    *s*     *ID*     *3255*

Reconnection time when grid code trip has happened in stop state. Disables drive starting when start command is given if Stop State reconnection time has not passed.

*P 2.17.6.3 ReConRampUpRate*                    *%/s*     *ID*     *3297*

Power ramp up rate on reconnection.

*P 2.17.6.4 RampReleaseDelay*                    *ms*     *ID3421*

Delay in reconnection situation when output power limit is started to ramp up after drives start modulating.

#### 7.16.3.1 Line OK Limits

Separate Grid OK levels when reconnection is allowed. If these values are zero, tripping limits for voltage and frequency are used also as a OK limit. If Grid Frequency and Voltage are not inside OK limit drive start is prevented even if Grid Frequency or Voltage trip limit has not been exceeded.

*P 2.17.6.5 LF OK High*                    *%*     *ID3287*

*P 2.17.6.6 LF OK Low*                    *%*     *ID3286*

*P 2.17.6.7 LV OK High*                    *%*     *ID3289*

*P 2.17.6.8 LV OK Low*                    *%*     *ID3288*

*P 2.17.6.9 Line OK Delay*                    *ms*     *ID3290*

Minimum time that line needs to be inside **acceptable** limits before reconnection counter is started.

#### 7.16.4 LINE VOLTAGE TRIP LIMITS

Line voltage (LV) trip levels and times to tripping. Times defines delay when drive sees that voltage has exceed set limit. Monitored signal may have hardware and/or software filtering function that will need to be considered when estimating total tripping time. Each tripping limit is independent of each other. Reference voltage is P2.1.1 Grid Nom. Voltage (100 %).

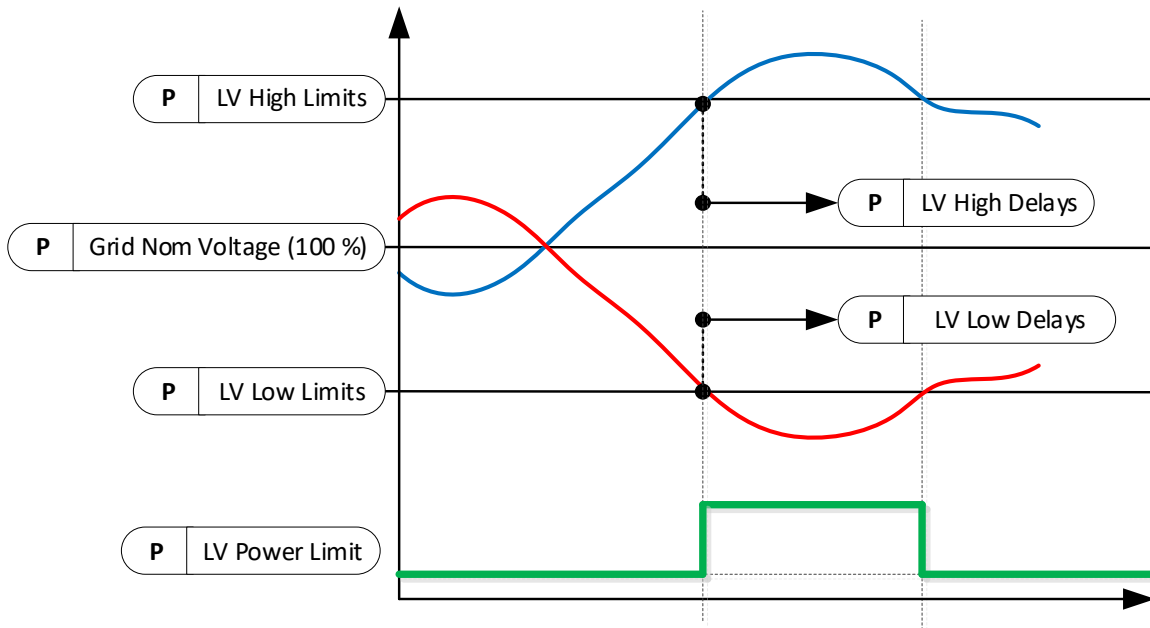

#### P 2.17.7.1 Voltage Monitor

ID3364

Line Voltage monitoring type

0 = Average voltage from phase voltages

This monitors average voltage of all three phases main voltages.

1 = Minimum and Maximum from phase voltages.

This monitors average voltage of all three phases and individual phase main voltages.

2 = Separate Average and BiPhase voltage monitor.

This monitors average voltage of all three phases and individual phase main voltages and gives over Grid Code trip sub code for each phase.

3 = Average and Fast BiPhase voltage monitor

This monitors average voltage of all three phases main voltages. And new less filtered phase voltages, certain test the grid overvoltage situation was detected about 60 ms earlier.

**P 2.17.7.2   LV High 1                                      %      ID3256**

Line Voltage High Limit 1, % of Grid Nominal Voltage.  
Trip after delay defined by ID3257.

**P 2.17.7.3   LV High 1 Delay                                      ms      ID3257**

Line Voltage High 1 Delay to trip when voltage above ID3256.

**P 2.17.7.4   LV High 1 PLim                                      %      ID3412**

Output power limit activated immediately when line voltage exceeds ID3256

**P 2.17.7.5   LV High 2                                      %      ID3258**

Line Voltage High Limit 2, % of Grid Nominal Voltage.  
Trip after delay defined by ID3259.

**P 2.17.7.6   LV High 2 Delay                                      ms      ID3259**

Line Voltage High 2 Delay to trip when voltage above ID3258.

**P 2.17.7.7   LV High 2 PLim   %      ID      3413**

Output power limit activated immediately when line voltage exceeds ID3258.

**P 2.17.7.8   LV High 3                                      %      ID      3361**

Line Voltage High Limit 3, % of Grid Nominal Voltage.  
Trip after delay defined by ID3262.  
When voltage is above this level also power is limited to ID3362

**P 2.17.7.9   LV High 3 Delay                                      ms      ID      3362**

Line Voltage High 3 Delay to trip when voltage above ID3261.

**P 2.17.7.10   LV High 3 PLim                                      %      ID      3363**

Output power limit activated immediately when line voltage exceeds ID3261

**P 2.17.7.11   LV Low 1                                      %      ID      3260**

Line Voltage Low Limit 1, % of Grid Nominal Voltage.  
Trip after delay defined by ID3261.

**P2.17.7.12**    *LV Low 1 Delay*                      *ms*    *ID*    *3261*

Line Voltage Low 1 Delay to trip when voltage below ID3260.

**P2.17.7.13**    *LV Low 1 PLim*                      %    *ID*    *3414*

Output power limit activated immediately when line voltage falls below ID3260.

**P2.17.7.14**    *LV Low 2*    %    *ID*    *3262*

Line Voltage Low Limit 2, % of Grid Nominal Voltage.

Trip after delay defined by ID3263.

**P2.17.7.15**    *LV Low 2 Delay*                      *ms*    *ID*    *3263*

Line Voltage Low 2 Delay to trip when voltage below ID3262.

**P2.17.7.16**    *LV Low 2 PLim*                      %    *ID*    *3415*

Output power limit activated immediately when line voltage falls below ID3262.

**P2.17.7.17**    *LV Low 3*    *ID3365*

Line Voltage Low Limit 3, % of Grid Nominal Voltage.

Trip after delay defined by ID3366.

When voltage is below this level also power is limited to ID3365

**P2.17.7.18**    *LV Low 3 Delay*                      *ID3366*

Line Voltage Low 3 Delay to trip when voltage below ID3365.

**P2.17.7.19**    *LV Low 3 PLim*                      *ID3367*

Output power limit activated immediately when line voltage falls below ID3365.

**P2.17.7.20**    *LV Low 4*                      *ID3416*

Line Voltage Low Limit 4, % of Grid Nominal Voltage.

Trip after delay defined by ID3417.

When voltage is below this level also power is limited to ID3418

**P2.17.7.21**    *LV Low 4 Delay*                      *ID3417*

Line Voltage Low 4 Delay to trip when voltage below ID3416

**P2.17.7.22 LV Low 4 PLim ID3418**

Output power limit activated immediately when line voltage falls below ID3416.

**P 2.17.7.23 10 Min average voltage trip level % ID3353**

This parameter defines 10-minute average voltage trip limit.

**P 2.17.7.24 10 Min Average Voltage Trip Delay ID3376**

Defines delay for 10 min average voltage monitoring.

**P 2.17.7.25 Voltage Response Time ID3410**

Define here voltage response time, this time is subtracted from set tripping time.

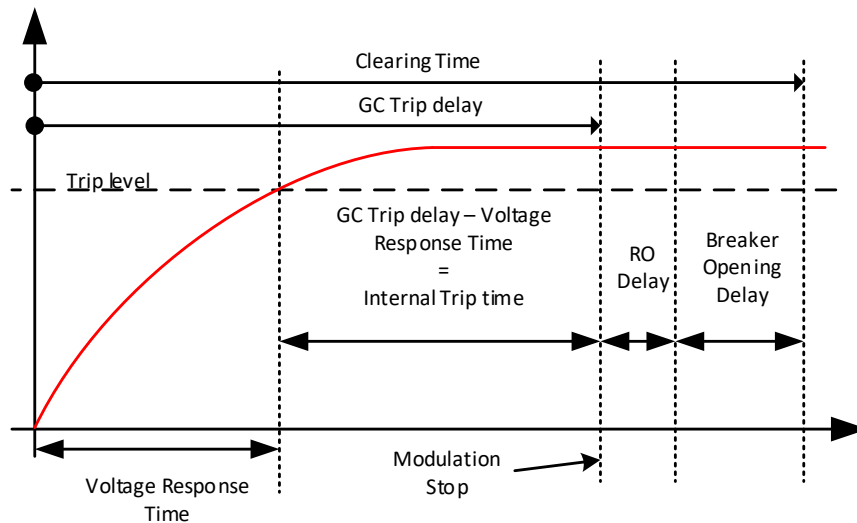
**P2.17.7.26 Power Limit Ramp Down Rate ID3419 "PLim Down Rate"**

When power limit by voltage limit is activated this is the ramp rate how fast limit is ramping down.

### 7.16.5 LINE FREQUENCY TRIP LIMITS

Line frequency (LF) trip levels and times to tripping. Times defines delay when drive sees that frequency has exceed set limit. Monitored signal may have hardware and/or software filtering function that will need to be considered when estimating total tripping time.

Reference frequency is P2.1.2 Grid Nom Freq (100 %).

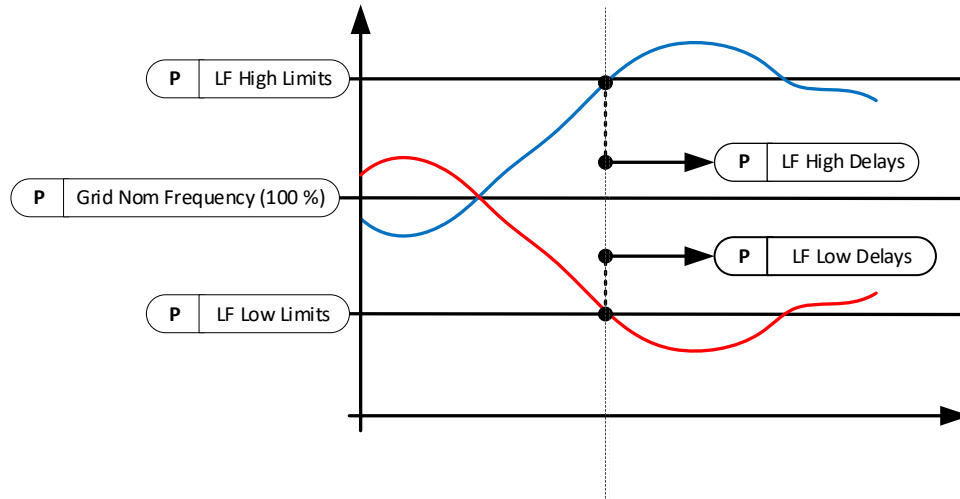

#### P 2.17.8.1 *Frequency Monitoring Mode* ID3423

Line Frequency monitoring modes.

0 = Normal

1 = Low filtered frequency below 500 ms trip times.

#### P 2.17.8.2 *LF High 1* % ID3264

Line Frequency High Limit 1 % of Grid Nominal Frequency.

#### P 2.17.8.3 *LF High 1 Delay* ms ID3265

Line Frequency High Limit 1 trip delay.

#### P 2.17.8.4 *LF High 2* % ID3266

Line Frequency High Limit 2 % of Grid Nominal Frequency.

#### P 2.17.8.5 *LF High 2 Delay* ms ID3267

Line Frequency High Limit 2 trip delay.

#### P 2.17.8.6 *LF High 3* % ID3368

Line Frequency High Limit 3 % of Grid Nominal Frequency.

**P 2.17.8.7 LF High 3 Delay ms ID3369**

Line Frequency High Limit 3 trip delay.

**P 2.17.8.8 LF Low 1 % ID3268**

Line Frequency Low Limit 1 % of Grid Nominal Frequency.

**P 2.17.8.9 LF Low 1 Delay ms ID3269**

Line Frequency High Limit 1 trip delay.

**P 2.17.8.10 LF Low 2 % ID3270**

Line Frequency Low Limit 2 % of Grid Nominal Frequency.

**P 2.17.8.11 LF Low 2 Delay ms ID3271**

Line Frequency High Limit 2 trip delay.

**P 2.17.8.12 LF Low 3 % ID3370**

Line Frequency Low Limit 3 % of Grid Nominal Frequency.

**P 2.17.8.13 LF Low 3 Delay ms ID3371**

Line Frequency High Limit 3 trip delay.

**P 2.17.8.14 LF MaxChangeRate Hz/s ID3514**

Tripping if line frequency has changed more than set value inside one (1) second.

**P 2.17.8.15 Frequency Response Time ID3399**

Define here frequency response time, this time is subtracted from tripping time.

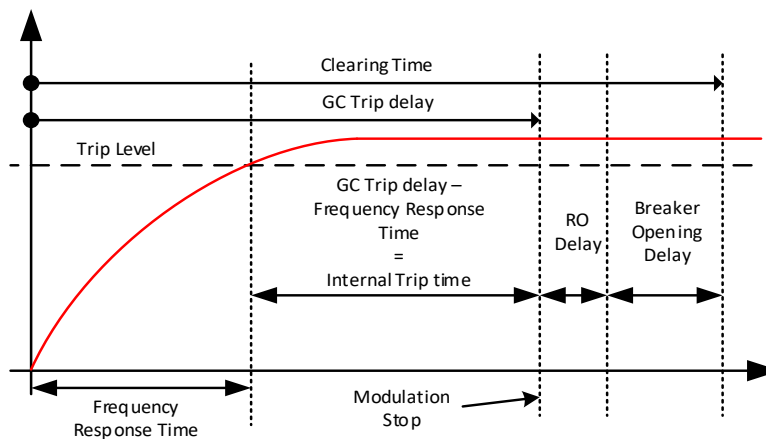

**P2.17.8.16 Time Off Cycles ID3411**

Off timer when voltage goes below the tripping limit. This is used when tripping time is below 500 ms and low filtered frequency value is used for tripping functions. One cycle is 5 ms

**7.16.6 REACTIVE CURRENT INJECTION (DYNAMIC)**

Reactive current injection functions purpose is to support grid voltage and/or feed current to short circuits in the grid, thus activating other protection devices.

Reactive current injection is activated by ID3252.

Some grid codes are mentioning k-factor, this is simply reactive current relation to voltage change. e.g. k-factor = 2; if grid voltage decreases 10 % the reactive current increases 20 %.

$$k = \frac{\frac{\Delta I_q}{I_n}}{\frac{\Delta U}{U_n}}$$

**P 2.17.9.1 UV Reactive Mode ID3314**

Select the operation mode for reactive reference handling for under voltage.

0 = Linear

1 = Power Lock In and Lock Out.

**P 2.17.9.2 OV Reactive Mode ID3377**

Select the operation mode for reactive reference handling for over voltage.

0 = Linear

1 = Power Lock In and Lock Out.



### 7.16.6.1 Linear reference under voltage

Injected reactive current is changing linearly between high and low voltage corners. Reactive current will have priority when voltage is below UV High Corner.

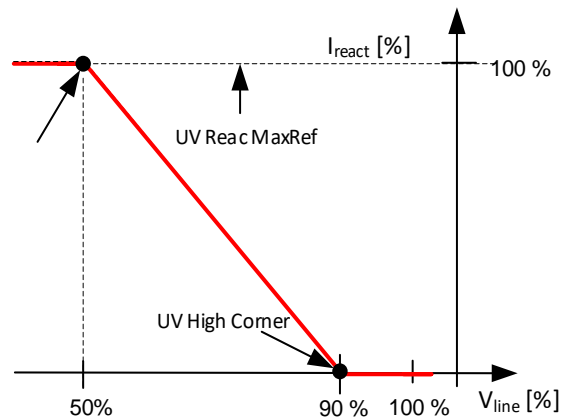

#### *P 2.17.9.3.1*      *UV High Corner*      %      *ID3291*

Defines voltage level where reactive current injection is started.  
Also, reactive current will get priority instead active current.

#### *P 2.17.9.3.2*      *UV Low Corner*      %      *ID3292*

Defines voltage level where full Reactive Current, specified in ID3293, is injected to the grid.

#### *P 2.17.9.3.3*      *UV Reac. Ref*      %      *ID3293*

Reactive current reference at low voltage corner.

#### *P 2.17.9.3.4*      *UV Bi Reac. Ref*      %      *ID3294*

Reactive current reference at low voltage corner on bi phase fault situation.

### 7.16.6.2 Linear reference over voltage

Reactive current is injected to over voltage with set slope.  
Reactive current has priority when voltage is above OV Low Corner.

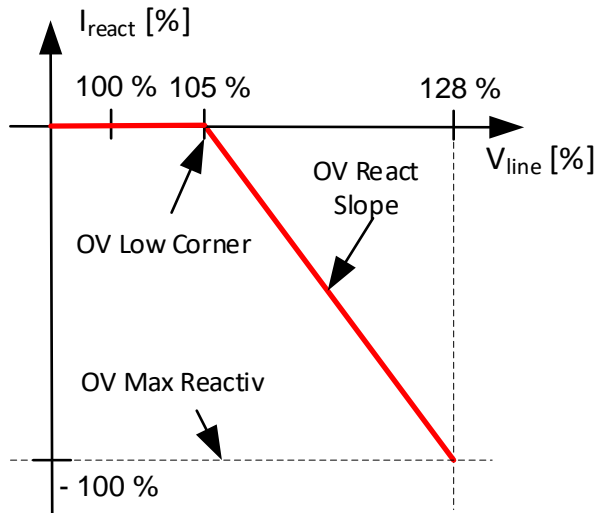

*P 2.17.9.4.1*      *OV Low Corner*      %      *ID3300*

Voltage corner where reactive current injection is started.  
Also, reactive current will get priority instead active current.

*P 2.17.9.4.2*      *OV Max Reactiv*      %      *ID3301*

Maximum reactive current reference on over voltage situation.

*P 2.17.9.4.3*      *OV React Slope*      %/%      *ID3302*

Slope how many percent reactive is increases when voltage changes one percent starting from over voltage low corner ID3300.

*P 2.17.9.4.4 Over Voltage React Power Log In [%] ID3303 "OV React PLogIn"*

If drive output power is below this reactive current injection is not started on over voltage.

*P 2.17.9.4.5 Over Voltage React Power Log Out [%] ID3329 "OV React PLogOut"*

When drive output power falls below this level reactive injection is stopped.

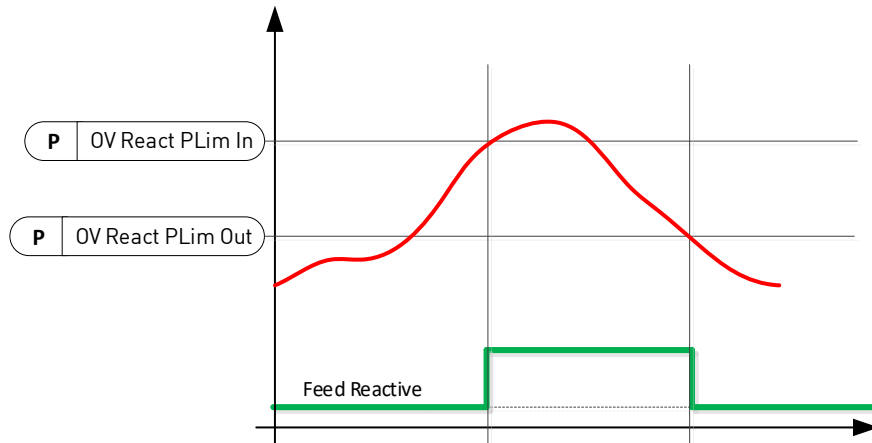

### 7.16.6.3 Power Lock In and Out Reference under voltage.

*P 2.17.9.5.1 Under Voltage PowerLockIn % ID3315*

Power level where reactive current injection is started if Line Voltage is below ID3291.

*P 2.17.9.5.2 Under Voltage PowerLockOut % ID3316*

Reactive current injection is stopped if power is below this value.

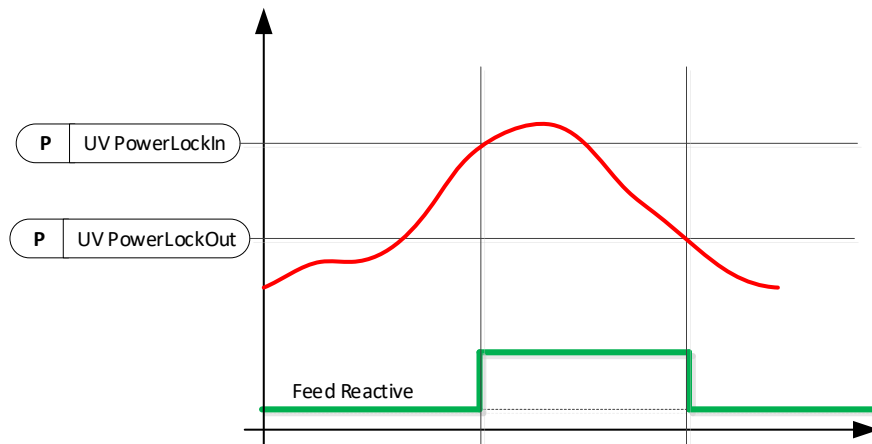

P 2.17.9.5.3 Under Voltage Power Log In Mode ID3372

"UV PowrLogInMode"

0 = Voltage Level Trlg

Two different voltage levels will trigger different reactive current injection.

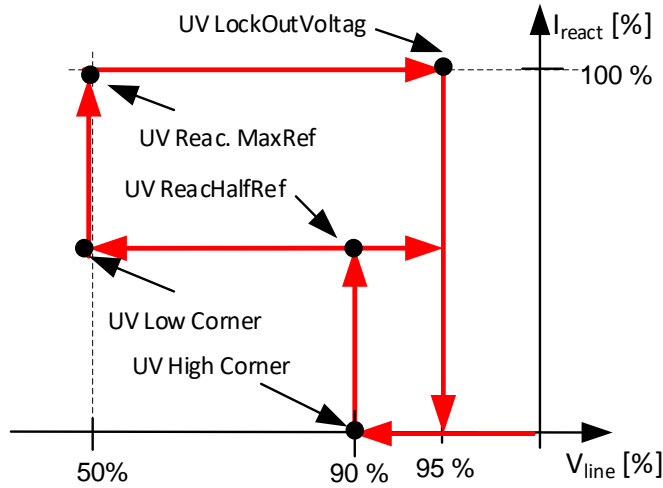

1 = Linear

UV Reac. Start V < UV High Corner

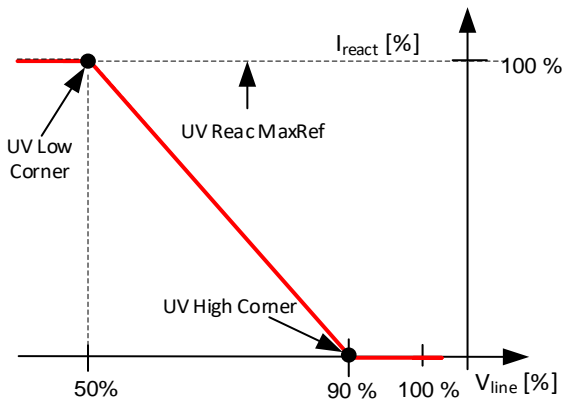

UV Reac. Start V > UV High Corner

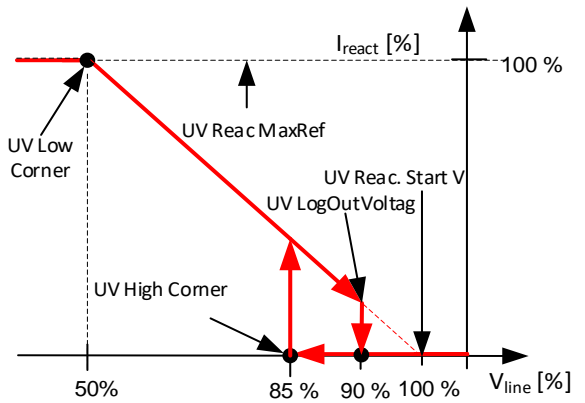

*P 2.17.9.5.4*      *UV High Corner*      %      *ID*      *3515*

If power is above ID3315 and voltage below this value but above ID3292 reactive current set by ID3318 is injected to grid. Also, Reactive Current will get priority over active Current.

*P 2.17.9.5.5*      *UV Low Corner*      %      *ID*      *3516*

If power is above ID3315 and voltage below this value, reactive current set by ID3293 is injected to grid.

*P 2.17.9.5.6*      *UV LockOutVoltag*      %      *ID*      *3317*

Voltage limit for disabling the reactive current injection in undervoltage situation

*P 2.17.9.5.7*      *UV ReacHalfRef*      *ID*      *3318*

Reactive current injected to grid when power is above ID3315 and Line voltage below ID3291 but above ID3292.

*P 2.17.9.5.8*      *UV Reac. MaxRef*      %      *ID*      *3517*

Reactive current injected to grid when power is above ID3315 and voltage below ID3292. This level is kept until voltage is above ID3311.

*P 2.17.9.5.9*      *UV BI ReacMaxRef*      %      *ID*      *3518*

Reactive reference used when Bi-phase fault, in both voltage levels.

*P 2.17.9.5.10*      *UV Reac.Start V*      %      *ID3444*

Starting point for reactive. Active when set higher than UV High Corner ID3291

#### 7.16.6.4 Power Lock In and Out Reference over voltage.

*P 2.17.9.6.1*      *OV PowerLockIn*      %      *ID*      *3378*

Power level where reactive current injection is started if Line Voltage is above ID3300.

*P 2.17.9.6.2*      *OV PowerLockOut*      %      *ID*      *3379*

Reactive current injection is stopped if power is below this value.

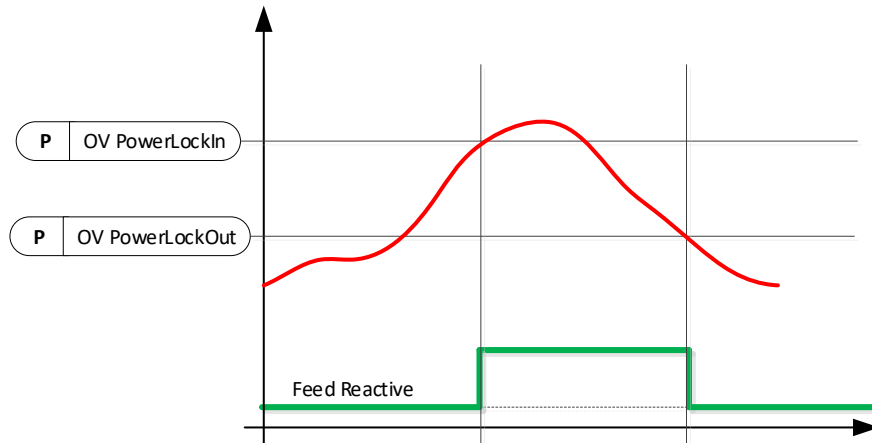

2.17.9.5.3 *OV PowerLogInMode* ID3380

0 = Voltage Level Trig

Two different voltage levels will trigger different reactive current injection.

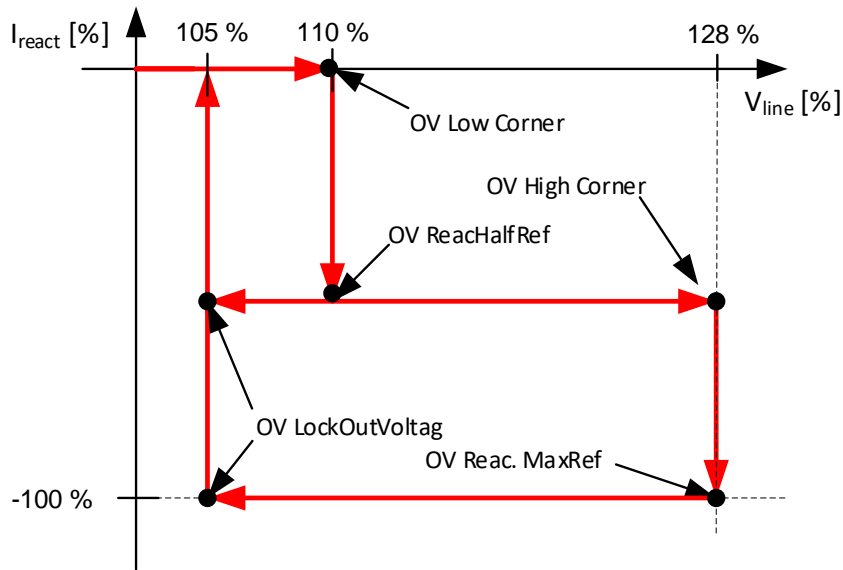

1 = Linear 3phase

OV REac. Start V < 50 %

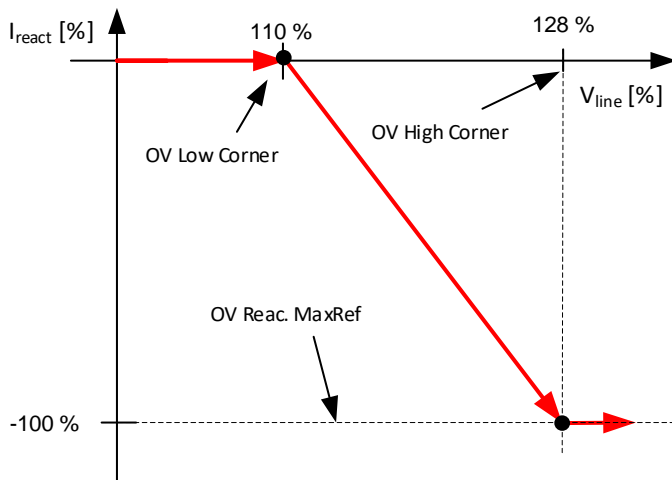

UV REac. Start V > 50 %

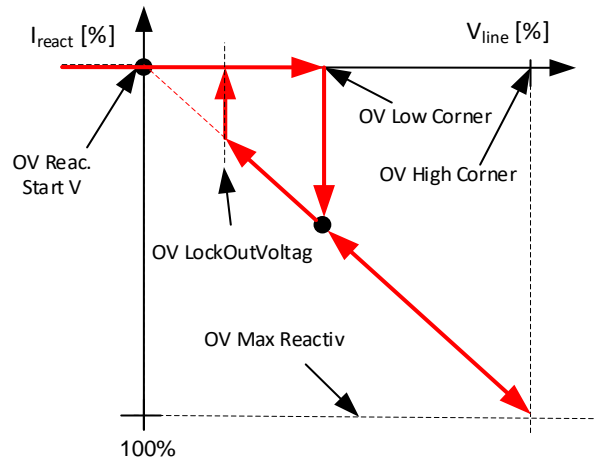



***P 2.17.9.6.4 OV Low Corner % ID 3519***

If power is above ID3315 and voltage above this value but below ID3320 reactive current set by ID3321 is injected to grid. Also, Reactive Current will get priority over Active Current.

***P 2.17.9.6.5 OV High Corner % ID 3320***

If power is above ID3315 and voltage above this value, reactive current set by ID3301 is injected to grid.

***P 2.17.9.6.6 OV LockOutVoltag % ID 3319***

Reactive current injection is stopped if voltage is below this value.

***P 2.17.9.6.7 OV ReacHalfRef ID 3321***

Reactive current injected to grid when power is above ID3315 and Line voltage above ID3300 but below ID3320.

***P 2.17.9.6.8 OV Max Reactiv % ID 3543***

Reactive current injected to grid when power is above ID3315 and voltage above ID3320. This level is kept until voltage is below ID3319.

***P 2.17.9.6.9 OV Reac.Start V % ID3445***

Starting point for reactive. Active when set higher than 50 % ID3291

### 7.16.6.5 Dynamic Grid Support

Reactive current feed for three phase fault and one phase faults. When active other reactive current injection functions are disabled. This function also enables internally P2.17.5.3 Symmetrical Reactive ID3323.

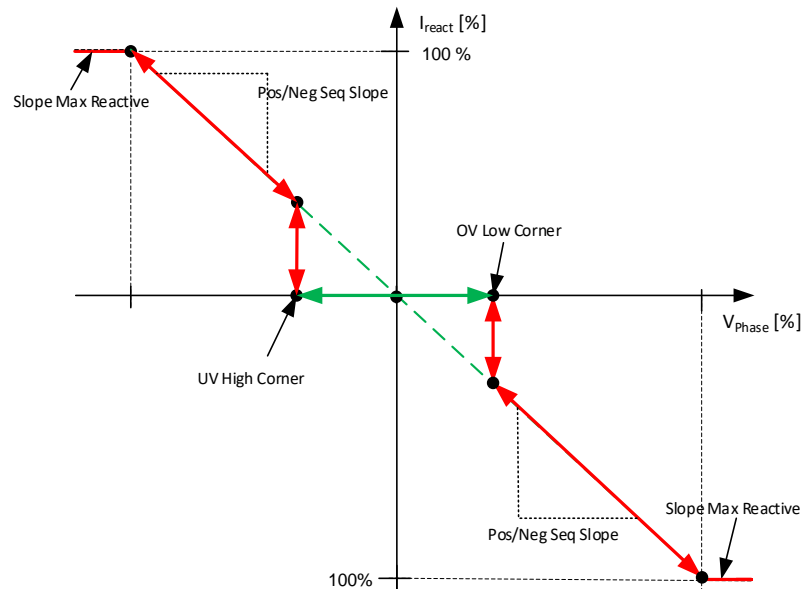

*P 2.17.9.7.1* *OV Low Corner*      %      3501

*P 2.17.9.7.2* *UV High Corner*      %      3502

These two parameters define normal operation range. Function disabled if both or one value is zero. Reactive current injection is started if one or more of the phase voltages exceeds upper or lower limit. Reactive injection is stopped after phase voltages returns inside normal operation range.

*P 2.17.9.7.3* *PosSeqSlope*      %/%      3504

Defined positive sequence reactive current injection current slope for positive sequence voltage. Range 0 to 6. Defines how many percentages reactive will change when positive sequence voltage changes one percent.

*P 2.17.9.7.4* *NegSeqSlope*      %/%      3505

Defined negative sequence reactive current injection slope for negative sequence voltage. Range 0 to 6. Defines how many percentages reactive will change when negative sequence voltage changes one percent.

*P 2.17.9.7.5* *SlopeMaxReactive*      %      3503

Maximum limit for positive and negative sequence reactive current.

*P 2.17.9.7.6* *Sudden Positive Sequence change limit*      %      3506      *"SudPosChanLim"*

*P 2.17.9.7.7* *Sudden Negative Sequence change limit*      %      3507      *"SudNegChanLim"*

Reactive current injection is also started when there is sudden change in positive or negative sequence voltage, current injection is started when instantaneous pos/neg

sequence voltage exceeds threshold compared to 1 second average pos/neg sequence voltage. Reactive injection is stopped after delay (ID3510) when phase voltages has returned inside normal operation range (ID3501 & ID3502).

***P 2.17.9.7.8 RampZeroTime      s      3508***

When reactive current injection is stopped this parameter defines ramp rate how fast reactive current is ramped to zero from this function.

***P 2.17.9.7.9 ResetHysteresis      %      3509***

Hysteresis for normal operation range, phase voltages needs to return inside the normal operation range plus this hysteresis before reactive current injection is reset.

***P 2.17.9.7.10 SuddenOffDelay      s      3510***

This defined delay when sudden change reactive injection is reset after phase voltages has returned inside normal operation range.

### 7.16.7 REACTIVE POWER CONTROL

These functions do not have priority over each other. And can be active at the same time.

#### 7.16.7.1 Q(U) Power

Reactive power reference based on grid voltage. Independently from Linear and Power Lock in modes. Priority is selected with P2.17.16.13 Current Priority. In this curve reactive is always zero at nominal voltage.

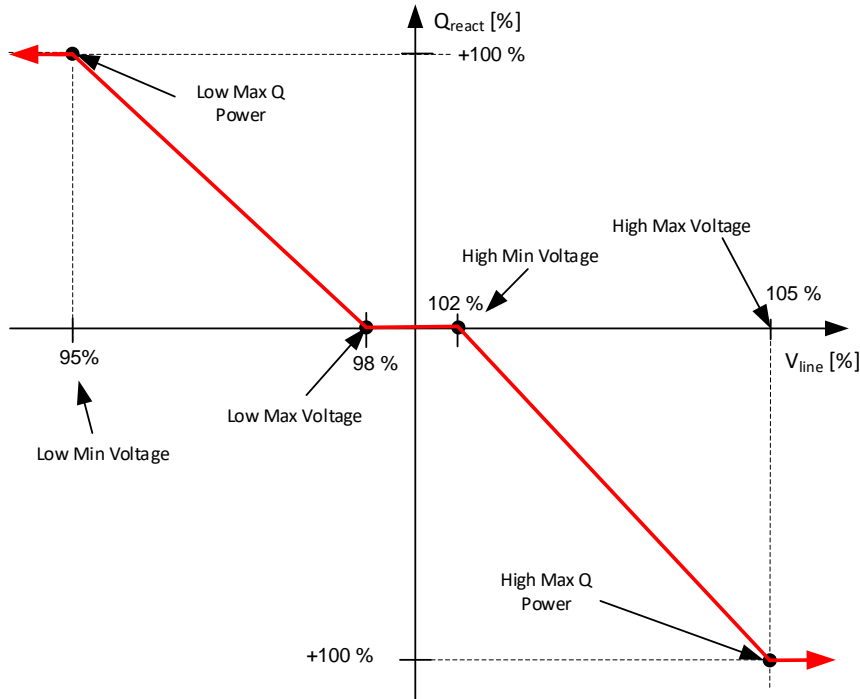

#### P2.17.10.1.1 High Max Q Power ID3341

Maximum reactive power when over voltage is at Max.

#### P2.17.10.1.2 High Max Voltage ID3340

Over voltage level when maximum reactive power is injected to grid.

#### P2.17.10.1.3 High Min Voltage ID3339

Over voltage level when reactive power is started to inject to grid.

#### P2.17.10.1.4 Low Max Voltage ID3343

Under voltage level when reactive power is started to inject to grid.

#### P2.17.10.1.5 Low Min Voltage ID3342

Under voltage level when maximum reactive power is injected to grid.

#### P2.17.10.1.6 Low Max Q Power ID3344

Maximum reactive power when under voltage is at min.

P2.17.10.1.7 PowerOffsetToVac ID3557

Power dependent voltage offset. Setting 2 % will offset curve with +2 % when active power is at 100 % discharging (DC to AC). And offset by -2 % when power is 100 % charging (AC to DC).

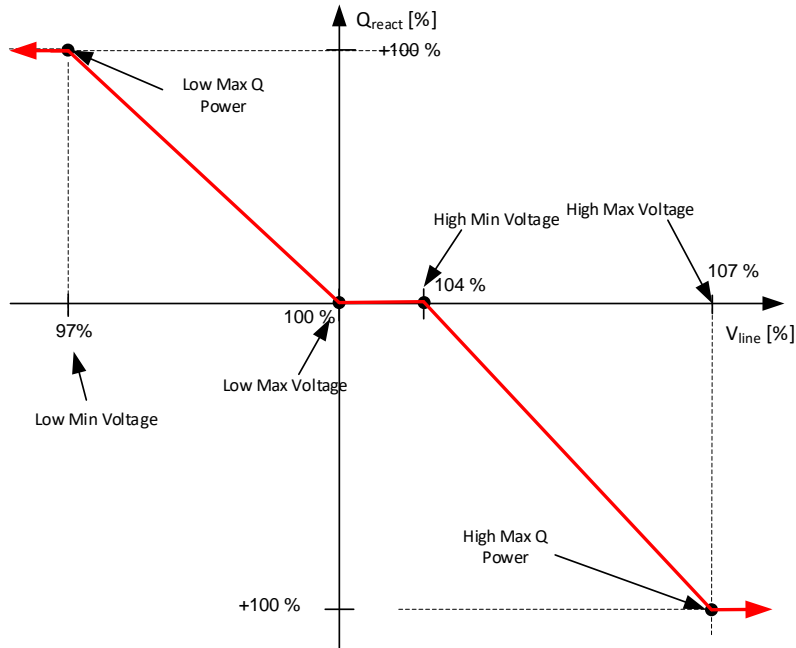

Figure 14. 2 % offset when power is 100 % from AC to DC, charging.

P2.17.10.1.8 VacOffsetPQU ID3558

Fixed voltage offset.

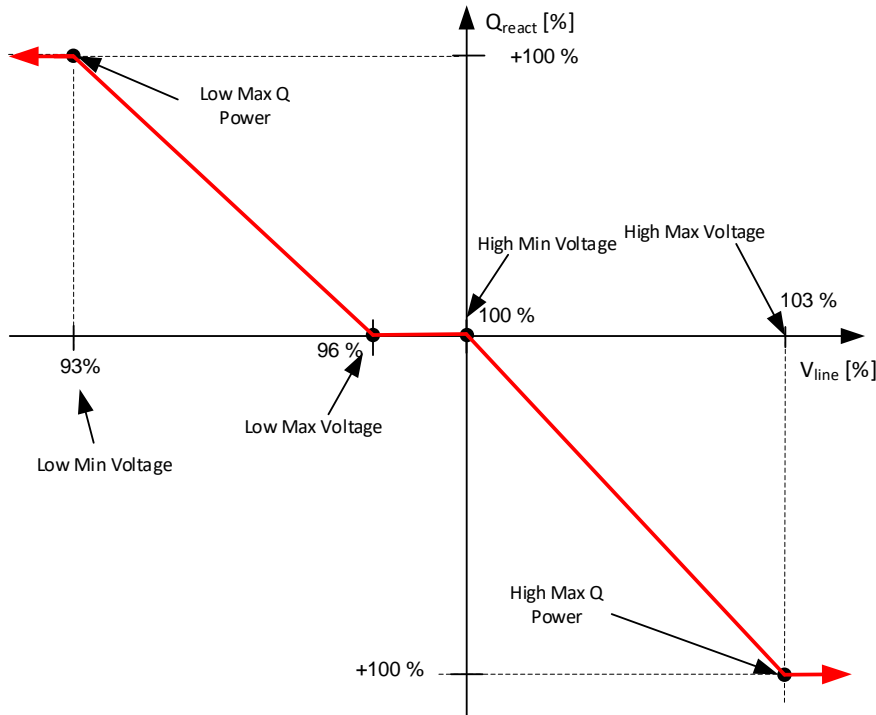
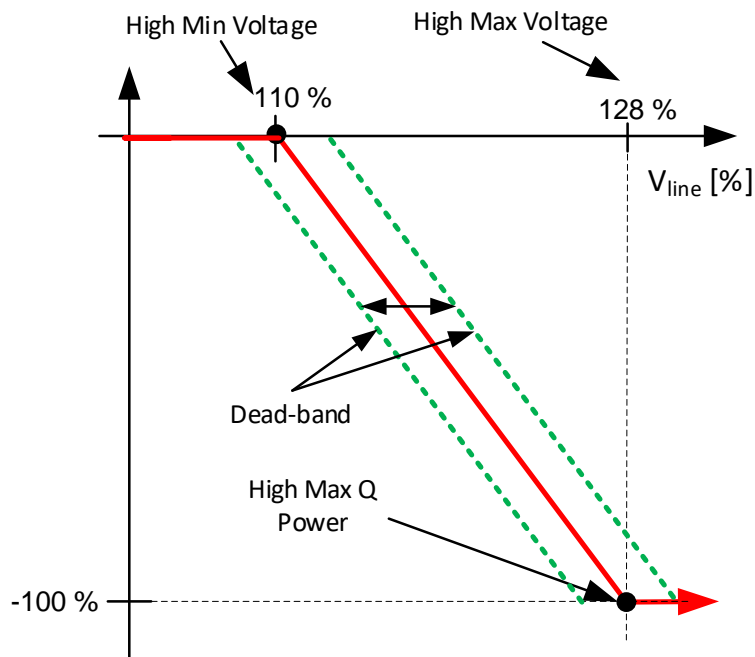

Figure 15. +2,00 % offset

*P2.17.10.1.9 Vac Dead-band ID3559*

Defines dead-band area that voltage change needs to be exceed before reactive reference is changed. Once voltage has changed one second stable time is needed for voltage before dead-band is activated again.



### 7.16.7.2 Q(U) Curve

Reactive power reference based on grid voltage. Freely programmable. Priority is selected with P2.17.16.13 Current Priority.

Use negative reference for low voltage, negative reactive reference increases grid voltage.

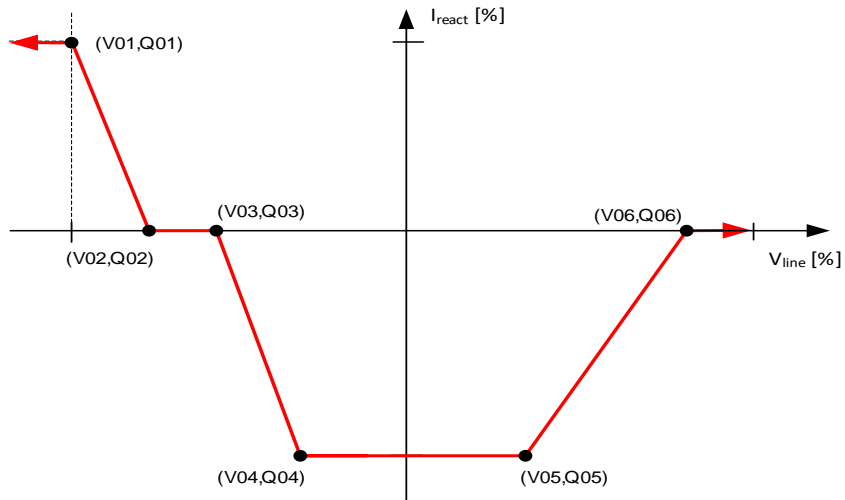

P 2.17.10.2.1	Voltage 01	%	3385
P 2.17.10.2.2	Q Power 01	%	3391
P 2.17.10.2.3	Voltage 02	%	3386
P 2.17.10.2.4	Q Power 02	%	3392
P 2.17.10.2.5	Voltage 03	%	3387
P 2.17.10.2.6	Q Power 03	%	3393
P 2.17.10.2.7	Voltage 04	%	3388
P 2.17.10.2.8	Q Power 04	%	3394
P 2.17.10.2.9	Voltage 05	%	3389
P 2.17.10.2.10	Q Power 05	%	3395
P 2.17.10.2.11	Voltage 06	%	3390
P 2.17.10.2.12	Q Power 06	%	3396

### 7.16.7.3 Q(P) Curve

Set reactive power in relation to active power. Here active power negative means power flow from AC side to DC side, same way as in Base Current Reference. With Control Options 2 B1 it is possible to change Active Current sign to be same way as Base Current Reference.

Use negative reference for low voltage, negative reactive reference increases grid voltage. Priority is selected with P2.17.16.13 Current Priority.

**NOTE:** These parameters are updated to operation only in stop state

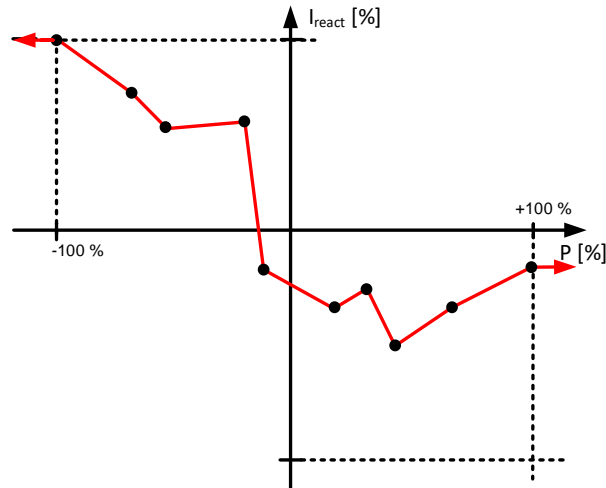

P 2.17.10.2.1	Power 01	%	3520
P 2.17.10.2.2	Q(P)Power 01	%	3530
P 2.17.10.2.3	Power 02	%	3521
P 2.17.10.2.4	QP Power 02	%	3531
P 2.17.10.2.5	Power 03	%	3522
P 2.17.10.2.6	QP Power 03	%	3532
P 2.17.10.2.7	Power 04	%	3523
P 2.17.10.2.8	QP Power 04	%	3533
P 2.17.10.2.9	Power 05	%	3524
P 2.17.10.2.10	QP Power 05	%	3534
P 2.17.10.2.11	Power 06	%	3525
P 2.17.10.2.12	QP Power 06	%	3535
P 2.17.10.2.13	Power 07	%	3526
P 2.17.10.2.14	QP Power 07	%	3536
P 2.17.10.2.15	Power 08	%	3527
P 2.17.10.2.16	QP Power 08	%	3537
P 2.17.10.2.17	Power 09	%	3528



---

<i>P 2.17.10.2.18</i>	<i>QP Power 09</i>	<i>%</i>	<i>3538</i>
<i>P 2.17.10.2.19</i>	<i>Power 10</i>	<i>%</i>	<i>3529</i>
<i>P 2.17.10.2.20</i>	<i>QP Power 10</i>	<i>%</i>	<i>3539</i>

#### 7.16.7.4 Options

##### *P2.17.10.4.1 Reactiv. Out TC      s      ID3546*

Defines time constant for reactive current when there is a reference change from Q(U) Power and Q(U) Curve functions.

## 7.16.8 POWER LIMIT

### 7.16.8.1 General

#### P 2.17.11.1 Power Ramp Up Rate ID3324

Limits power increase rate. Negative value will disable power increase rate limiter.

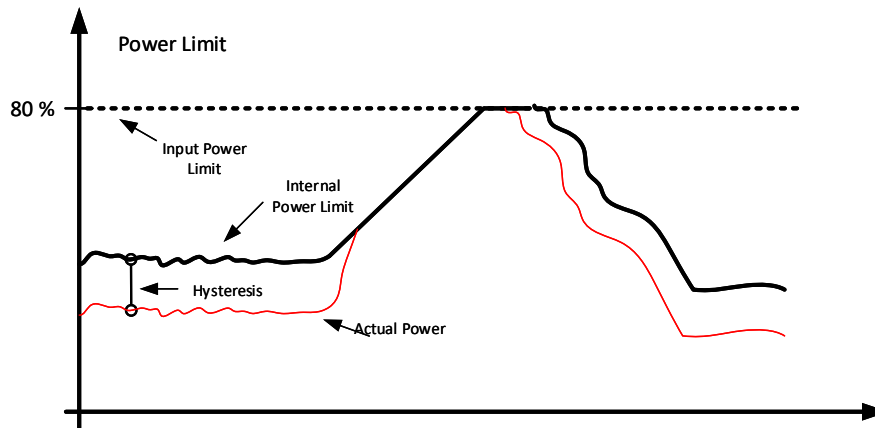

#### P 2.17.11.2 Maximum Output Power with Grid Codes ID3397 "GC Max Power"

This parameter sets the power limit for the discharging/generator side operation of the regenerative unit. 100.0% is equal to nominal current at nominal voltage at OPT-D7 measurement point. Discharging/Generator Side operations is when power flows from DC side to AC side. Setting too low value may lead to over voltage fault even on situation when power is not intended to be regenerate to grid side.

#### P 2.17.11.1.3 Maximum Input Power with Grid Codes ID3439 "GC Min Power"

Maximum input power that is allowed to use when Grid Codes are active.

This parameter sets the power limit for the charging/motor side operation of the regenerative unit. 100.0% is equal to nominal current at nominal voltage at unit output terminals. Motoring Side operations is when power flows from AC side to DC side.

#### P 2.17.11.1.4 Stop Power Ramp Rate ID3555

Defines ramp rate for power when stop command is given.

7.16.8.2 High Frequency Power Limit

Select power limit behavior on high line frequency.

P2.17.11.2.1 HighFreqModes ID 3307

Parameter select how minimum power limit is handled.

0 = High Limit

Power limit will follow set scaled line.

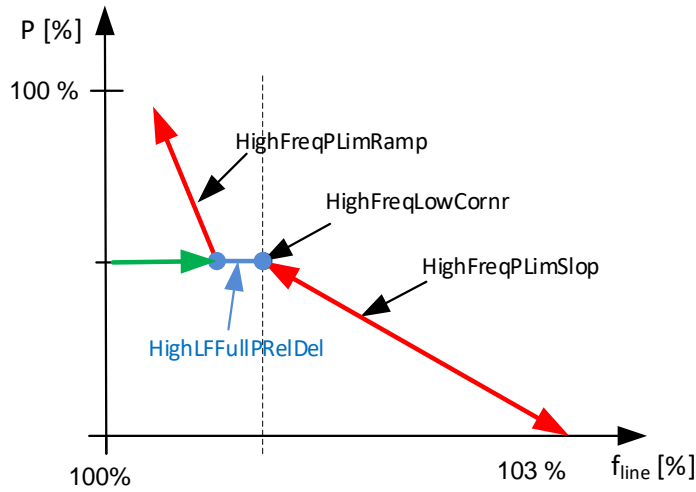

1 = Minimum

Power limit is kept at magnum level set by scaled line until lock out conditions are met.

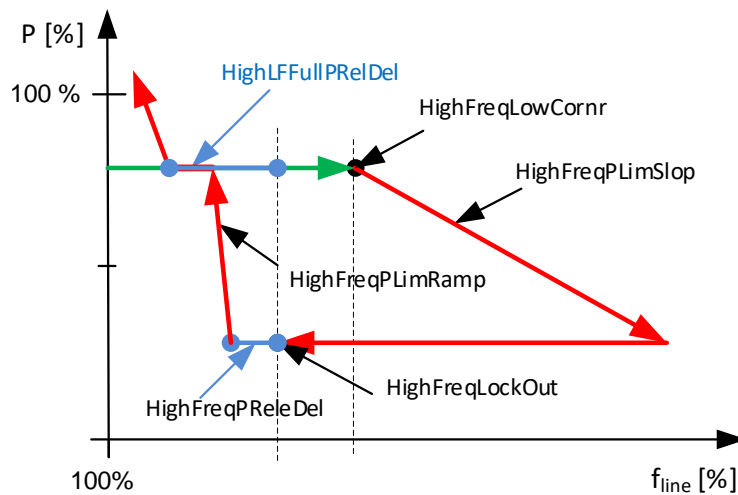

***P2.17.11.2.2 HighFreqLowCornr           %    ID    3295***

High Frequency Low Corner, limiting function is activated when this parameter is above 100,00 %.

Corner where power limiting is started on high line frequency. There is a 100 ms delay before limiting is started. Limiting delay can be adjusted with HighFreqLimOnDelay.

***P2.17.11.2.3 HighFreqPLimSlop  %/Hz ID    3239***

High Frequency Power Limit Slope

Slope for power limit. If set to zero, function will use P2.17.11.1.9 High Freq High Corner and P2.17.11.1.10 High Freq Power Ratio. Use this parameter when power is needed to reduce with certain slope. Use P2.17.11.1.7 High Freq High Corner and P2.17.11.1.8 High Freq Power Ratio when power limits need to be in certain value at certain frequency.

***P2.17.11.2.4 HighFreqLockOut           %    ID    3308***

High Frequency Lock Out

Below this limit power limitation is stopped. P2.17.11.1.6 can be used to define delay before power limit is released.

***P2.17.11.2.5 HighFreqPLimRamp       %/s   ID    3298***

High Frequency Power Limit Ramp.

Power limit increase ramp rate used after power is released to normal operation.

***P2.17.11.2.6 HighFreqPReleDel       ms    ID    3299***

Delay how long limit is kept after frequency is below HighFreqLockOut.

***P2.17.11.2.7 HighLFFulIPReIDel  ms    ID3374***

High Line Frequency Full Power Release Delay

When this is activated power is limited for this time to level where power was when High Frequency Low corner was exceeded.

***P2.17.11.2.8 HighFreqLimOnDelay       ms    ID3402***

High Frequency Limit On Delay.

This parameter defines delay before limiting of power is activated when frequency exceeds HighFreqLowCornr.

### 7.16.8.3 High Frequency Power Limit with absolute high frequency limit

This mode is active if HighFreqPLimSlop is set to zero.

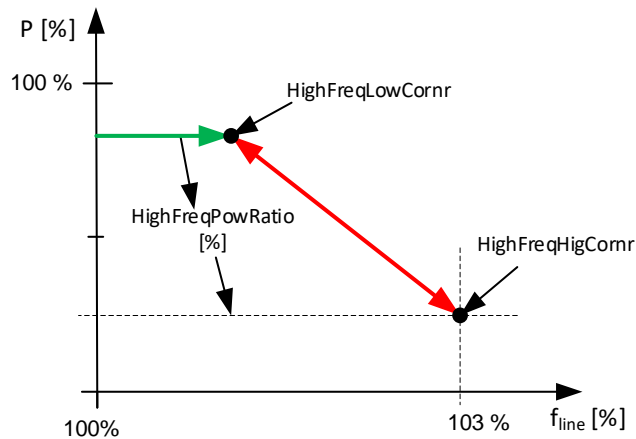

#### P2.17.11.2.9 HighFreqHigCornr      %    ID    3296

Frequency corner where minimum power limit is used. If power limitation is defined with slope use P2.17.1.1.3 parameter to define slope.

#### P2.17.11.2.10 HighFreqPowRatio      %    ID    3309

Power level in relation to actual power when ID3295 was exceeded to be used at ID3296 corner.

### 7.16.8.4 High Voltage Power Limit

#### P2.17.11.3.1 Limit Mode ID3360

Parameter select how minimum power limit is handled.

0 = High Limit

Power limit will follow set scaled line.

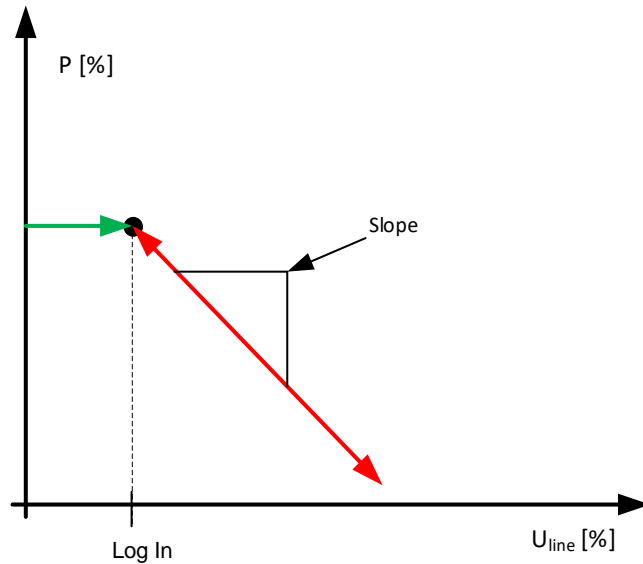

1 = Minimum

Power limit is kept at minimum level set by scaled line.

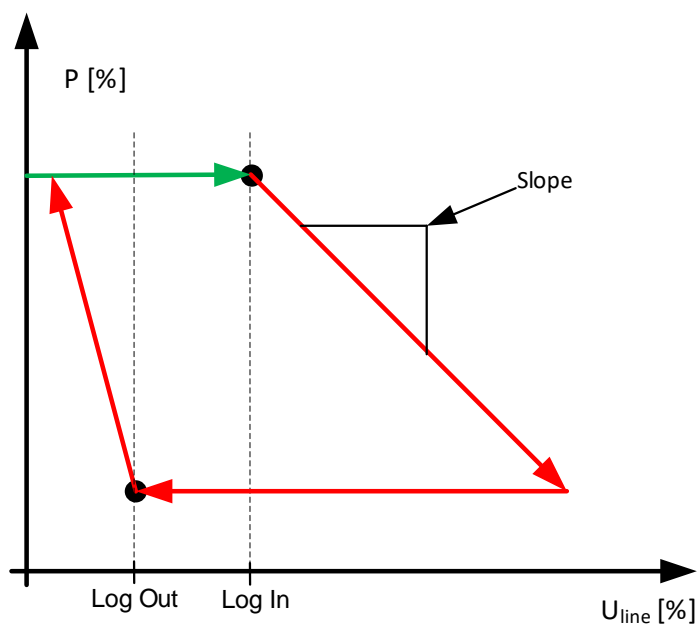

***P2.17.11.3.2 Log In Voltage [%] ID3325***

High voltage level when power will be started to limit by the defined slope. Power limit will not increase until voltage has gone below Log Out Voltage Level.

***P2.17.11.3.3 Log Out Voltage [%] ID3326***

Low Voltage Level where power limit is released if line voltage has increased above Log In Voltage Level

***P2.17.11.3.4 Limit Slope [%/%] ID3327***

Slope how many percentages limit is decreased when voltage increases one percent when voltage goes above Log In Voltage. Function is disabled when this parameter is zero.

***P2.17.11.3.5 Power Limit Release Delay ID3424***

Defines delay after power limit is released when voltage has gone below Log Out Voltage.

***P2.17.11.3.6 Power Limit Release Ramp Rate ID3425***

Ramp rate for power limit when released from High Voltage power limit function. if normal power increase rate if slow drive will follow the slowest ramp rate.

### 7.16.8.5 Low Voltage Charge Limit

This function will limit charging power (input power) when grid voltage decreases.

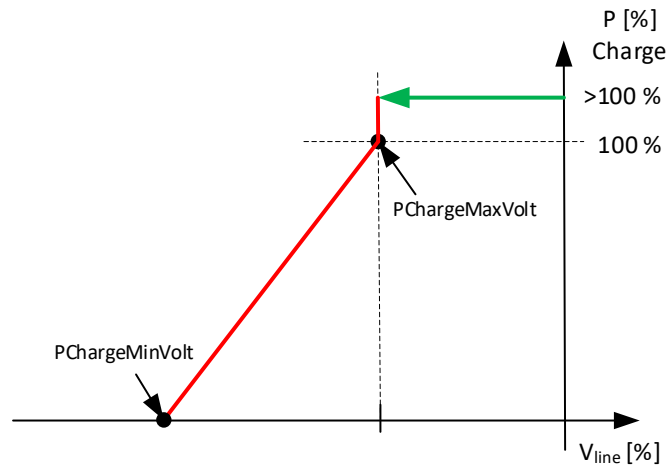

#### P2.17.11.4.1 $P_{ChargeMaxVolt}$ ID3347

Voltage level where limiting is started. When this limit is reached charging power limit is lowered to 100 % is higher from some other function.

#### P2.17.11.4.1 $P_{ChargeMinVolt}$ ID3348

Voltage level where charging power limit reached minimum level.



7.16.8.6 Low Frequency Charge Limit

This function will limit charging power when grid frequency decreases.

P2.17.11.5.1 *PChargeLimitMode ID3354*

Parameter to select if power limit changed linearly based on frequency or stays at reached minimum level until lock out frequency has been reached.

0 = High Limit

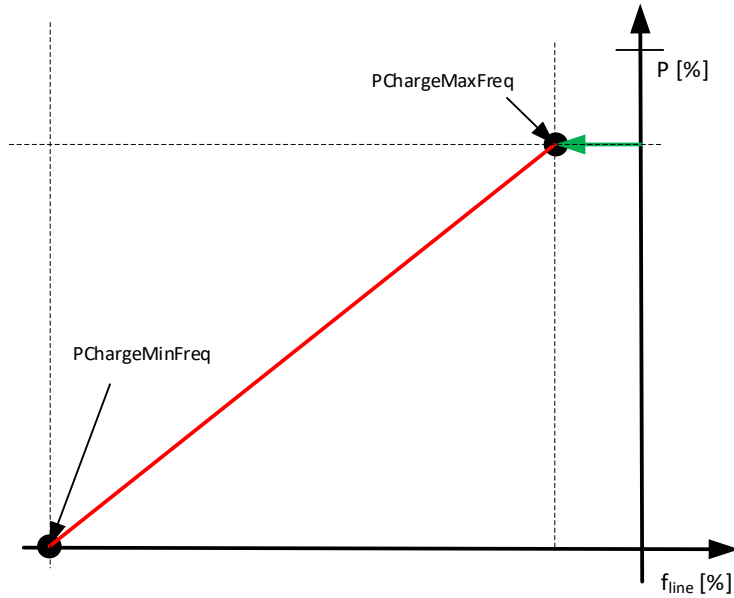

1 = Minimum

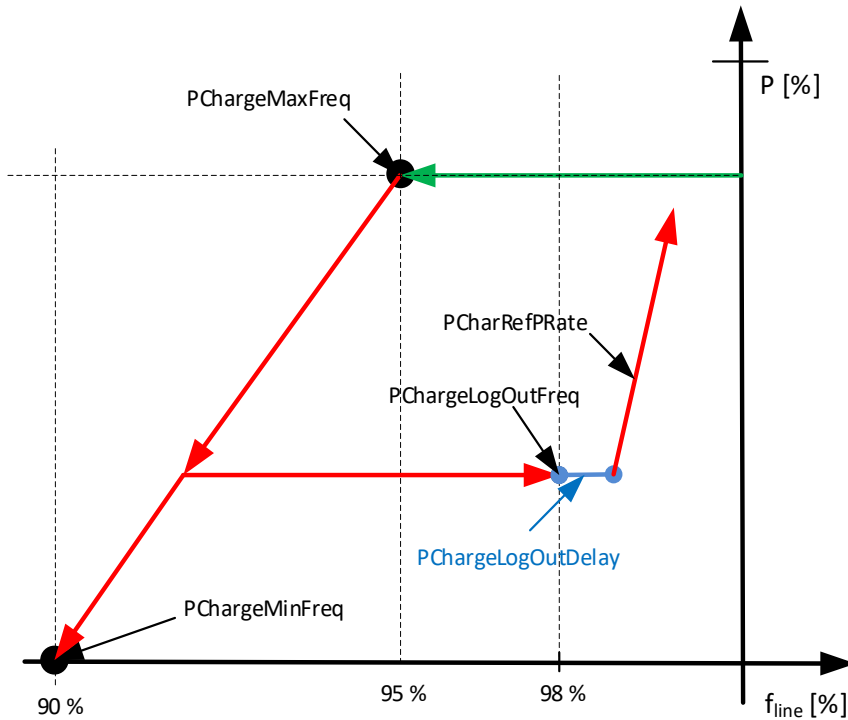

***P2.17.11.5.2 PChargeMaxFreq ID3349***

Frequency point where charging limit is started to decrease starting from current active power level.

***P2.17.11.5.3 PChargeMinFreq ID3350***

Frequency point where charging limit reached minimum.

***P2.17.11.5.4 PChargeLogOutFreq ID3351***

Frequency level where charging limit is released once limiting has been active.

***P2.17.11.5.5 PChargeLogOutDelay ID3352***

Delay to release charging power limit once lock out frequency has been reached.

***P2.17.11.5.6 PCharRefPRate ID3355***

Separate power increase rate for this function when power is released by this function.

***P2.17.11.5.7 PChargeOnDelay ID3403***

Delay to activate Low Freq Charge Limit

7.16.9 POWER REFERENCE

7.16.9.1 Low Frequency Power Reference

With this function drive can increase power output to grid automatically without upper system control when there is a frequency decrease in the grid. Base current reference is still operational compared to same function in Grid Code group where Base Current reference is frozen during the event.

Power Increase Log Off Frequency = Zero

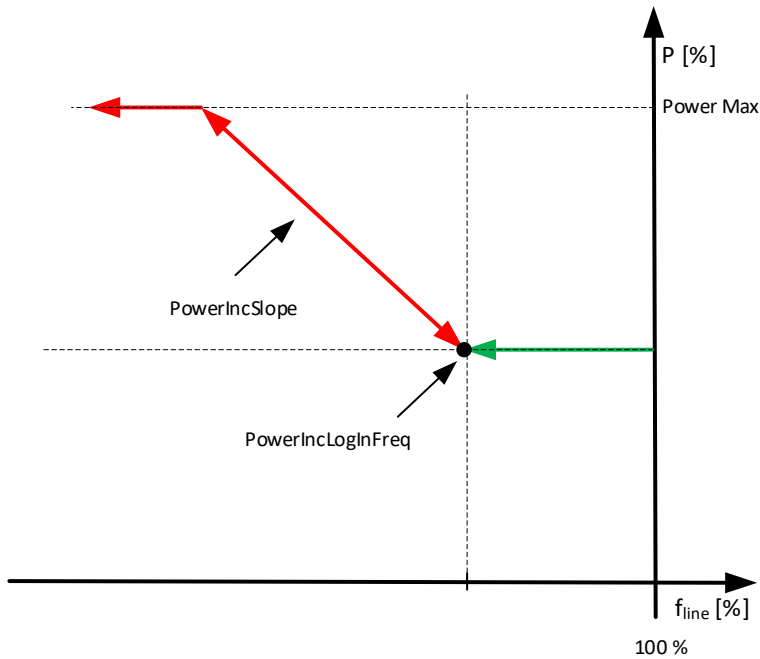

Power Increase Log Off Frequency > Zero

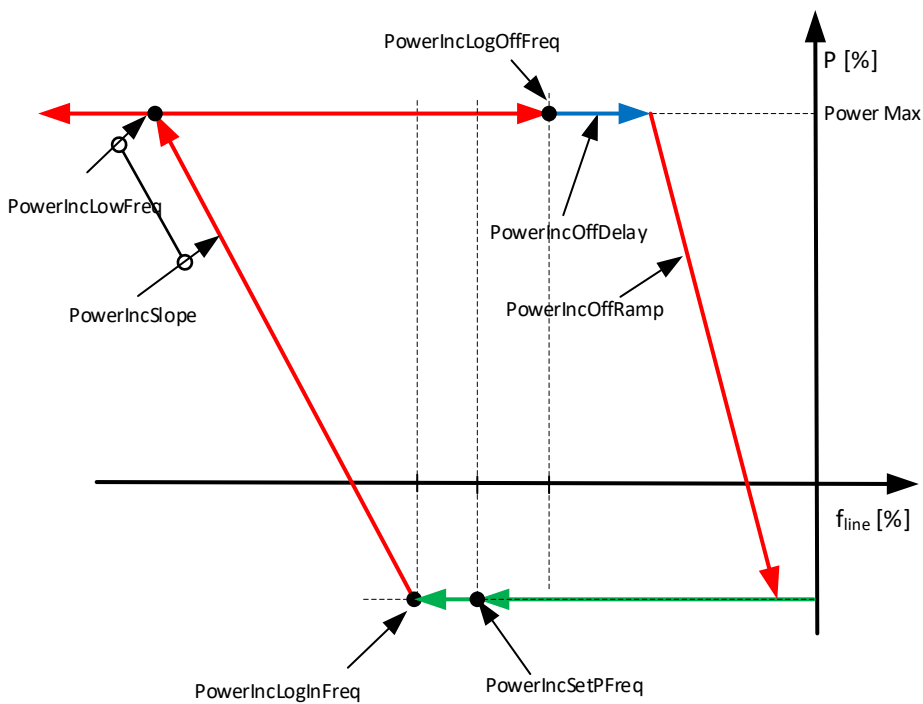

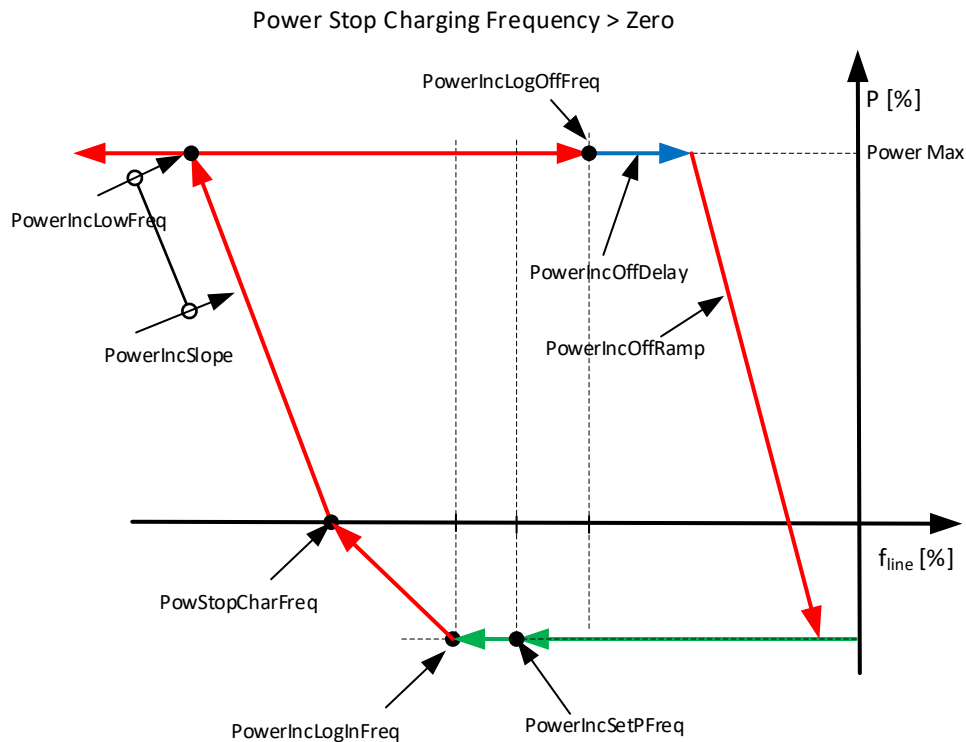

#### P2.17.12.1.1 *PowerIncLogInFreq* [%] ID3334 "PowerIncLogInFreq"

Frequency when power is started to increase. Also sets power level from where increase is started, if ID3443 is zero. (In some standard this point is called t3 knee point).

#### P2.17.12.1.2 *PowerIncLogOffFrequency* ID3437

Power Increase Log off frequency. Frequency level when function is disabled and delay and or ramp to normal power level is started, If set.

#### P2.17.12.1.3 *Power Increase Slope* [%/%] ID3335 "PowerIncSlope"

Slope how many percent power is increased when frequency changes one percent. Calculated internally if ID3441 is greater than zero.

#### P2.17.12.1.4 *Power Increase Off Ramp* ID3427

Ramp rate when power is returned to original level when frequency returns above log of level and delay has passed.

#### P2.17.12.1.5 *Power Increase Off Delay* ID3438

Delay after frequency has returned to normal level when power is started to ramp back to original level.

**P2.17.12.1.6 Power Increase Max****ID3336**

This parameter limit how much this function an increase power from starting point.

**P2.17.12.1.7 Power Increase Low Frequency****ID3441**

When this parameter is defined greater than zero drive will calculate power slope internally to reach this frequency point with maximum output power reference. If this is not defined ID3335 Power Increase Slope will define increase rate.

**P2.17.12.1.8 Power Increase Set Power Frequency****ID3443**

This parameter defines the frequency point what actual power is used as start reference when frequency falls below Log In Frequency. If zero log in frequency is used.

**P2.17.12.1.9 Power Stop Charging Frequency****ID3552**

This parameter defines point where charging power is controlled to zero. If not enabled drive will follow set slope rate or Power Increase Low Frequency ID3441 point.

**P2.17.12.1.10 Knee Point Increase****ID3553**

In CEI-16 this function moves the t3 knee point to higher frequency +0,20 Hz, this frequency increase is made in cases when charging power in bigger than 50 % of unit nominal power.

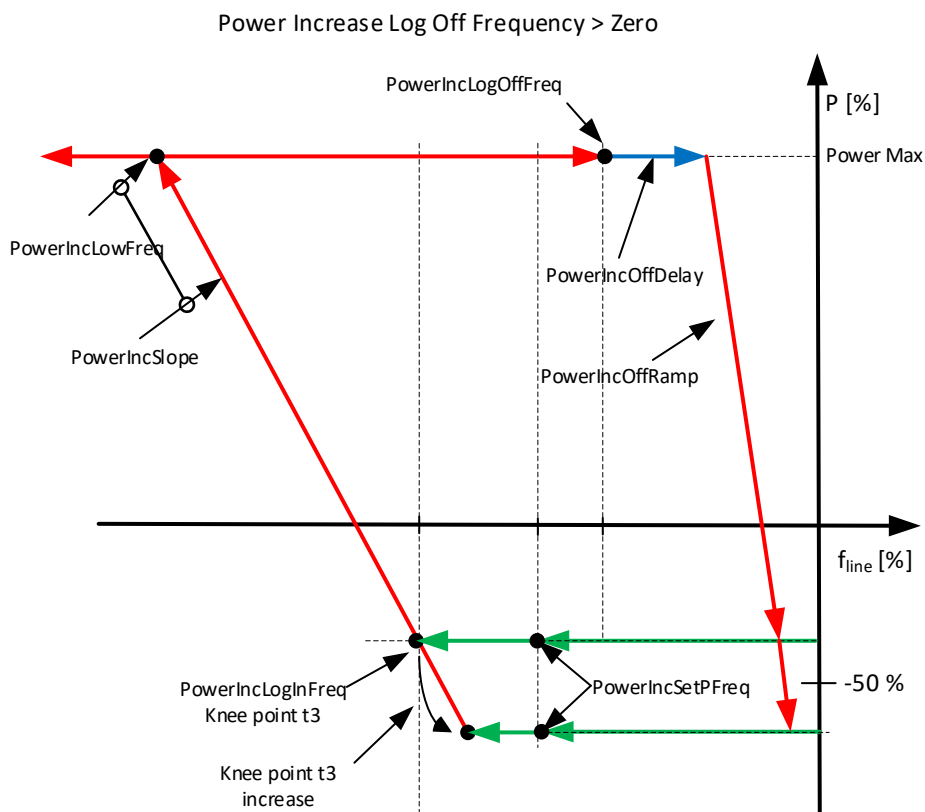

7.16.9.2 High Frequency Power Reference

With this function drive can decrease power output to grid automatically without upper system control when there is a frequency increase in the grid. Base Current reference is not operational during the event

Power Decrease Log Off Frequency = Zero

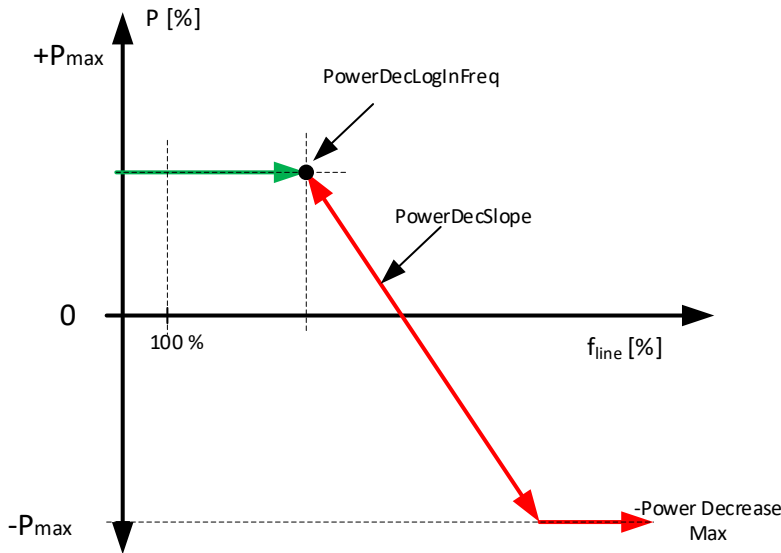

Power Decrease Log Off Frequency > Zero

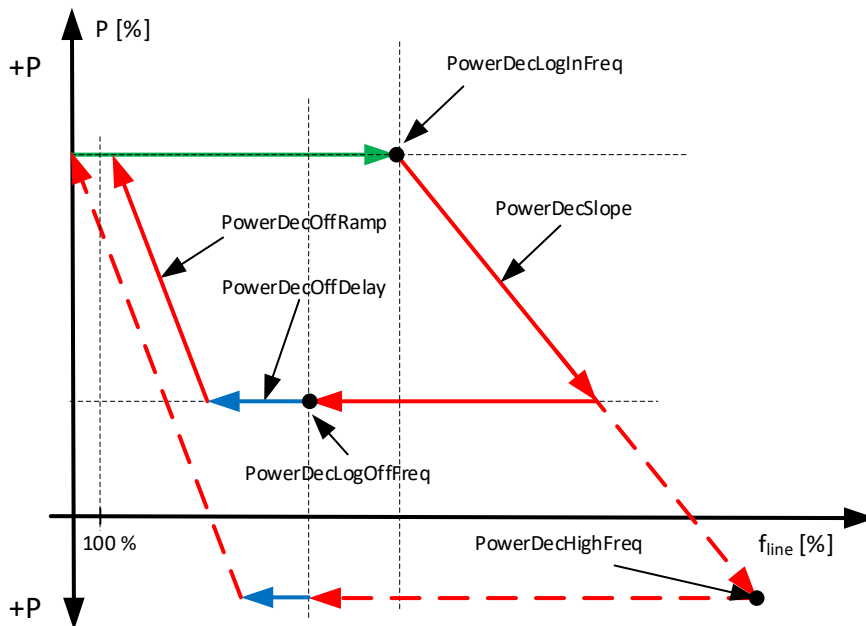

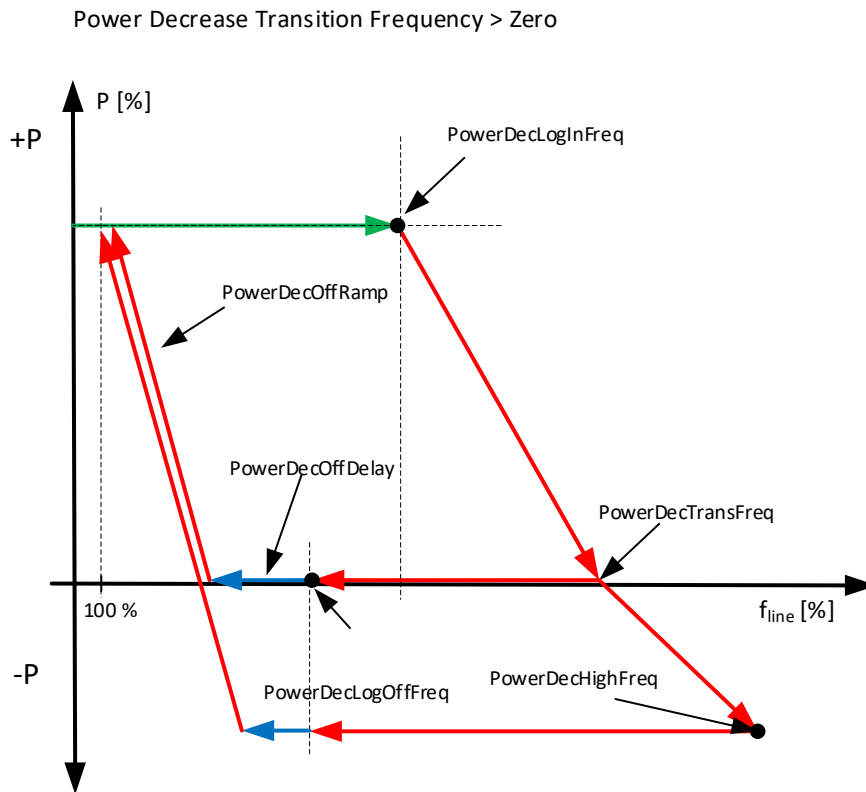

*P 2.17.12.2.1 PowerDecLogInFreq ID3428*

Log in frequency when power is started to decrease.

*P 2.17.12.2.2 PowDecLogOffFreq ID3436*

Log Off frequency when power is started to return to level before going above log in voltage.

*P 2.17.12.2.3 PowerDecSlope [%/%] ID3429*

Slope how many percentages power is changed when frequency changes one percent.

*P 2.17.12.2.4 PowerDecOffRamp ID3431*

Ramp rate that is used when power is released back to normal operation level.

*P 2.17.12.2.5 PowerDecOffDelay ID3435*

Delay when power is released after frequency has fall below log off level.

*P 2.17.12.2.6 PowerDec Max ID3430*

This parameter limit how much this function can decrease power from starting point.

*P 2.17.12.2.7 PowerDecHighFreq ID3442*

When this parameter is defined greater than zero drive will calculate power slope internally to reach this frequency point with maximum input power reference.

*P 2.17.12.2.8 PowDecTransFreq ID3551*

This parameter if different than zero will define frequency level where output power is ramped to zero. If frequency continue to increase charging reference will continue towards ID3442 PowerDecHighFreq.



### 7.16.9.3 High Voltage Power Reference

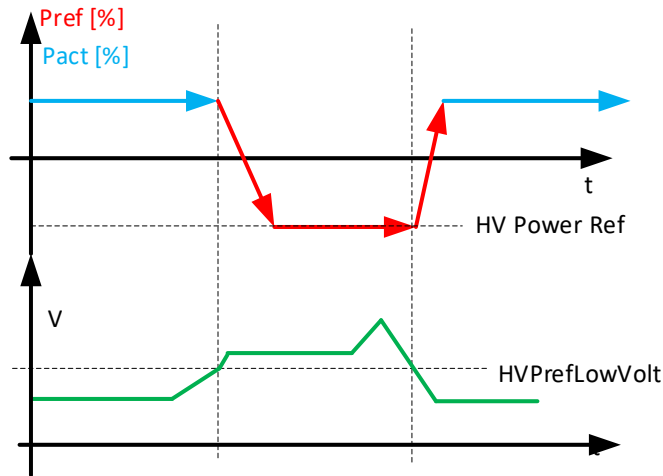

#### P 2.17.12.3.1 HVPrefLowVolt ID3432

High voltage level when power is started to decrease.

#### P 2.17.12.3.2 HV Power Ref ID3433

Power reference level that is used when line voltage is above ID3432.

#### P 2.17.12.3.3 HV Power Ramp ID3434

Ramp rate that is used when power is decreased and released back to normal operation.

### 7.16.9.4 Options

#### P2.17.12.4.1 Power RefRamp ID3449 "PowerRefRamp"

Forced Power PI Controller power reference ramp rate.

**7.16.10 Cos Phii Control**

*P 2.17.13.1 CosPhiiMode ID3345*

- 0 = Direct Reference
- 1 = Volt LogIn LogOut
- 2 = Act. Current

*P 2.17.13.2 CosPhiiRef ID 3304*

Direct Cos Phii reference. 1000=unity, 100=min, neg=capacitive

*P 2.17.13.3 Reserved*

**7.16.10.1 Lock In and Out control**

Cos Phii control is used at over voltage situations. Controller is activated when voltage is above Lock In Voltage and Active Current is more than 50 %. 1,0 ref at 50 % power and P:(Max Cos Ref) at 100 % power.

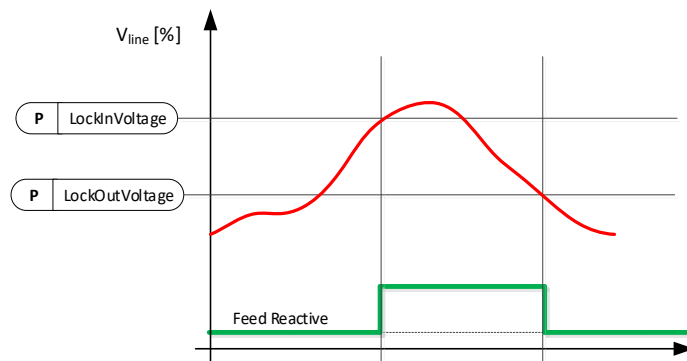

*P 2.17.13.3.1 LockInVoltage % ID 3305*

Voltage level when Cos Phii control is started.

*P 2.17.13.3.2 LockOutVoltage % ID 3306*

Voltage level when Cos Phii control is stopped.

*P 2.17.13.3.3 Max Cos Ref ID3346*

Cos Phii reference used when power is at 100 %.

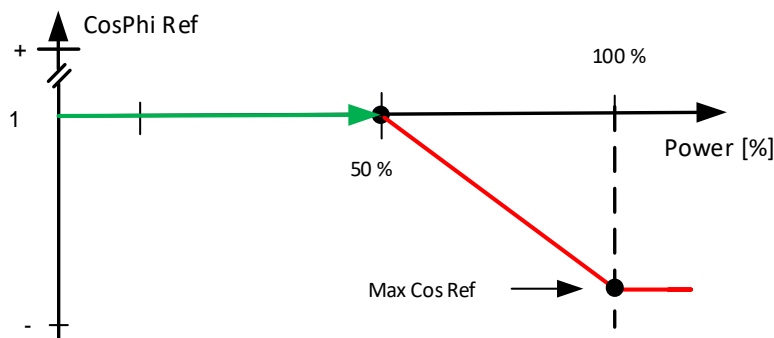

### 7.16.10.2 Cos Phii Active Current Control

Cos Phii reference is started to adjust above 50 % power and reach value set by ID3346 at 100 % Power.

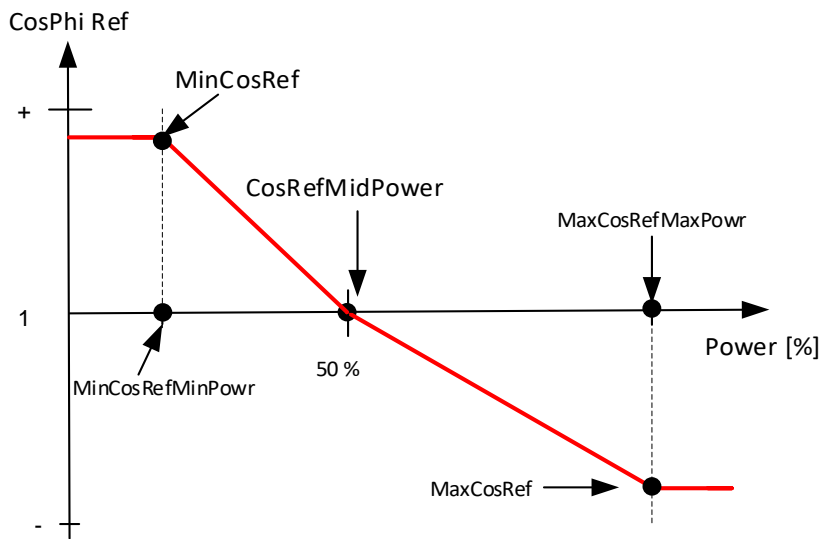

**P2.17.13.4.1 MinCosRefMinPower ID3357**  
Minimum power where Min Cos Ref is used

**P2.17.13.4.2 MinCosRef ID3356**  
Cos Phii Reference at Min Power point.

**P2.17.13.4.3 CosRefMidPower ID3358**  
Middle power point where Cos Phii Ref is 1,000

**P2.17.13.4.4 MaxCosRefMaxPower ID3359**  
Maximum power where Max Cos Ref is used

**P2.17.13.4.5 MaxCosRef ID3346**  
Cos Phii Reference at maximum power point.

**7.16.11 EXTERNAL INPUT**

External input to make a trip and/or to activate separate frequency limits for tripping.

*P 2.17.14.1 Ext GC Trip NO DigIN ID 3310*

Direct digital input to activate Grid Code trip function. Normally Open.

*P 2.17.14.2 Ext GC Trip NC DigIN ID 3398*

Direct digital input to activate Grid Code trip function. Normally Closed.

*P 2.17.14.3 SeparateFLimMon DigIn ID 3311*

Digital input to active more strict frequency trip limits.

*P 2.17.14.4 SepFreqHighLim % ID 3313*

Frequency high limit used to Grid Code trip when digital input defined by ID3311 is active.

*P 2.17.14.5 SepFreqLowLim % ID 3313*

Frequency low limit used to Grid Code trip when digital input defined by ID3311 is active.

**7.16.12 LIMITED GRID SUPPORT**

Limited Grid Support will force active power to zero and does not feed reactive current to the grid in case voltage falls below set Voltage Level.

*P2.17.15.1 EnableLimSup ID3446*

Digital input to enable limited support. Can be also enabled from fieldbus by connecting bit to ID3446.

*P2.17.15.2 LimitedSuppMode ID3447*

Select the mode of limited support.

*P2.17.15.3 Voltage Level Low [%] ID3448*

When limited support is activated and voltage falls below this, active power is forced to zero and no dynamic support reactive current is feed to the grid.

*P2.17.15.4 Voltage Level High [%] ID3542*

When limited support is activated and voltage rises above this, active power is forced to zero and no dynamic support reactive current is feed to the grid.

### 7.16.13 GRID CODE OPTIONS

#### *P2.17.16.1 Grid Code Options*

B00 = +1 = Activate this bit for Grid Code: GB/T 19964-2012.

B01 = +2 = Release Active Current limit to maximum during the FRT

#### *P2.17.16.2 Voltage Filt. TC ms 3332*

Filtering time constant for voltage that is used Grid Code monitoring.

#### *P2.17.16.3 Frequency Filt. TC ms 3333*

Filtering time constant for frequency that is used Grid Code monitoring.

#### *P2.17.16.4 FRT Options 3400*

B02 = Reserved

B03 = Reserved

B05 = Reserved

B06 = Reserved

B07 = Enable other Reactive Current Injections when Dynamic Support is active

B09 = Freeze other Reactive Current injections function when Dynamic Support activates.

#### *P2.17.16.5 Vac Stop Offset % 3337*

With this is possible to give offset for Grid Code voltage in stop state.

#### *P2.17.16.6 Vac Run Offset % 3338*

With this is possible to give offset for Grid Code voltage in run state.

#### *P2.17.16.7 Power Follower Hysteresis ID1529*

Power follower hysteresis.

#### *P2.17.16.8 LVHighFiltTC ID3373*

#### *P2.17.16.9 LineFreqLow TC ID3375*

*P2.17.16.10 FRT Trig Level ID3382*

*P2.17.16.11 Current x TC ID3409*

*P2.17.16.12 LV Feedback Kp ID3420*

*P2.17.16.13 CurrentPrioritySel ID3422*

Select priority operation mode between Active Current, Reactive Current and Cos Phii Reference.

0 = Normal Operation.

Operates as normal AFE concerning active and reactive priority. Active current has higher priority than reactive current.

1 = Active Current Priority

Operates as normal AFE concerning active and reactive priority. Active current has higher priority than reactive current.

This function will limit reactive current if DC-Link voltage margin start to reduce too small.

2 = Reactive Current Priority

Reactive current has higher priority than active current. At current limit active current is limited.

3 = Cos Phii Reference Priority

Cos Phii reference has priority, active current is limited to keep cos phi reference

4 = Cos Phii and Reactive Current priority

Cos Phii reference and Reactive current has priority over active current. Active current is limited at current limit.

*P2.17.16.14 LineFreqHigh TC ID3440*

Filtering time constant for

- G2.17.9.5 PowerLock UV; Linear 3p
- G2.17.9.6 PowerLock OV; Linear 3p
- G2.17.11.3 HighVoltPowerLim when slope is greater than 50,0 %/%
- G2.17.10.2 Q U Curve
- G2.17.10.1 Q U Power

*P2.17.16.15 Reactive Current Voltage Compensation ID3540*

Select if FRT functions current reference is pure current reference or if the reference is voltage compensated between 80 %...135 % of Un.

0 = Pure Reactive Current Reference

1 = Voltage Compensated (Reactive Power Reference)

This function affects

- G2.17.11.3 Linear UV
- G2.17.11.4 Linear OV
- G2.17.11.5 Power Lock UV
- G2.17.11.6 Power Lock OC

*P2.17.16.16 EON Trig Level ID3541**P2.17.16.17 Priority Margin % ID4532*

## 8. KEYPAD CONTROL PARAMETERS

Unlike the parameters listed above, these parameters are located in the **M3** menu of the control panel. The reference parameters do not have an ID number.

### *P3.1*      *Control Place*      *ID125*      *"Control Place"*

The active control place can be changed with this parameter. PC Control place can be only activated when from NCDrive when this parameter is set 2 / Keypad.

0 = PC Control, Activated by NCDrive

1 = I/O terminal

2 = Keypad

3 = Fieldbus

4 = SystemBus

On keypad control pressing Stop button more than a 2 second will open the MCB.

### *P3.2*      *License Key*      *ID1995*      *"License Key"*

Enter the licence key.

The standard AFE functions are available without a licence key. A licence key is not necessary for the frame FR4.

### *P3.3*      *SW Test LK*      *ID4502*

Parameter to activate development functions for testing purposes.



## 9. FB STATUS AND CONTROL IN DETAIL

P2.10.19 State machine	
1 / Basic	This mode makes fieldbus control operate as is explained in the fieldbus board manual.
2 / Standard	Simple control word that is used in modes where the control word from fieldbus is used as such. For some fieldbus boards this requires bypass operation.
3 / Vacon AFE 1	This mode uses a ProfiDrive type state machine in the application level. It is possible to use this mode on fieldbus boards that do not have a state machine or have a possibility to bypass the state machine function on the option board.

PRIFIBUS													
Parameter Field			Process Data Field										
ID	IND	Value	CW	Ref	PD1	PD2	PD3	PD4	PD5	PD6	PD7	PD8	
			SW	Act	PD1	PD2	PD3	PD4	PD5	PD6	PD7	PD8	
PPO1													
PPO2													
PPO3													
PPO4													
PPO5													

Modbus											
Process Data Field											
	CW	GCW	Ref	PD1	PD2	PD3	PD4	PD5	PD6	PD7	PD8
ID	SW	GSW	Act	PD1	PD2	PD3	PD4	PD5	PD6	PD7	PD8
	2101	2102	2103	2104	2105	2106	2107	2108	2109	2110	2111
ID	2001	2002	2003	2004	2005	2006	2007	2008	2009	2010	2011

- Byte
- ID Parameter type and number
- IND Parameter subindex
- Value Parameter vaue
- CW Control Word
- SW Status Word
- GCW General Control word
- GSW General Status wod
- Ref Reference Value 1
- ACT Actual Value 1
- PD Process Data

### 9.1 FB DC REFERENCE

Fieldbus DC reference is available when the Grid Converter is in fieldbus control. The format is the same as in panel references. (11000 = 110 %). If reference is not used from fieldbus, set the "FBSpeedReference" to zero. When FB reference is zero, the drive will use DC Voltage Reference from keypad parameter. Using "FBSpeedReference" gives faster response than using ProcessDataIn.

## 9.2 STATE MACHINE: BASIC

### 9.2.1 FB CONTROL WORD BASIC

Table 59.

FB Control Word: Basic			
	FALSE	TRUE	Comment
b0	Stop Request	Start Request	Use this for start and stop command
b1			
b2	No Action	Fault Reset 0 > 1	Use this for fault reset
b3	Fieldbus DIN1=OFF	Fieldbus DIN1=ON	See P2.5.1.17 -18
b4	Fieldbus DIN2=OFF	Fieldbus DIN2=ON	See P2.5.1.19 -20
b5	Fieldbus DIN3=OFF	Fieldbus DIN3=ON	See P2.5.1.21 -22
b6	Fieldbus DIN4=OFF	Fieldbus DIN4=ON	See P2.5.1.23 -24
b7			
b8			
b9			
b10			
b11			
b12			
b13			
b14			
b15			

B00: FALSE = Stop Request, TRUE = Start Request

**Stop Request:** Drive will stop modulating

**Start Request:** Drive will start modulating, rising edge needed after fault situation.

B02: FALSE = No Action, TRUE = Fault Reset

**Fault Reset:** Resets active faults.

### 9.3 STATE MACHINE: STANDARD

#### 9.3.1 CONTROL WORD: STANDARD

Table 60.

FB Control Word Standard			
	FALSE	TRUE	Comment
b0	Open CB	Charge DC	
b1			
b2			
b3	Stop Request	Run Request	Use this for start and stop command
b4			
b5			
b6			
b7	No Action	Fault Reset 0 > 1	Use this for fault reset
b8			
b9			
b10			
b11	Fieldbus DIN1=OFF	Fieldbus DIN1=ON	See P2.5.1.17 -18 also WD Pulse
b12	Fieldbus DIN2=OFF	Fieldbus DIN2=ON	See P2.5.1.19 -20
b13	Fieldbus DIN3=OFF	Fieldbus DIN3=ON	See P2.5.1.21 -22
b14	Fieldbus DIN4=OFF	Fieldbus DIN4=ON	See P2.5.1.23 -24
b15			

B00: FALSE = Open CB, TRUE = Charge DC

**Open CB:** The drive will stop modulating and open main circuit breaker.

**Charge DC:** The drive will start to precharge if the function is activated by a digital output and the control place is fieldbus. When charging is ready, the main circuit breaker is closed depending on "CB Close Mode" and "Enable CB Close" status.

When the control place is not fieldbus, precharge is started at a normal start command.

B03: FALSE = Stop Request, TRUE = Start Request

**Stop Request:** The drive will stop.

**Start Request:** Start Command to the drive.

B07: FALSE = No Action, TRUE = Fault Reset

**Fault Reset:** Resets active faults.

## 9.4 STATE MACHINE: VACON AFE 1

### 9.4.1 CONTROL WORD: VACON AFE 1

FB Control Word Vacon AFE 1			
	FALSE	TRUE	Comment
b0	Open CB	Charge DC	
b1			
b2			
b3	Stop Request	Run Request	Use this for start and stop command
b4			
b5			
b6			
b7	No Action	Fault Reset 0 > 1	Use this for fault reset
b8			
b9			
b10	Field Bus Control Disable	Fieldbus Control Enable	
b11	Watchdog pulse FALSE	Watchdog pulse TRUE	0>1>0>1...0.5 sec square wave clock. This is used to check data communication between fieldbus master and the drive.
b12	Fieldbus DIN2=OFF	Fieldbus DIN2=ON	See P2.5.1.19 -20
b13	Fieldbus DIN3=OFF	Fieldbus DIN3=ON	See P2.5.1.21 -22
b14	Fieldbus DIN4=OFF	Fieldbus DIN4=ON	See P2.5.1.23 -24
b15			

B00: FALSE = Open CB, TRUE = Charge DC

**Open CB:** The drive will stop modulating and open main circuit breaker.

**Charge DC:** The drive will start to precharge if the function is activated by a digital output and the control place is fieldbus. When charging is ready, the main circuit breaker is closed depending on "CB Close Mode" and "Enable CB Close" status.

When the control place is not fieldbus, precharge is started at a normal start command.

B03: FALSE = Stop Request, TRUE = Start Request

**Stop Request:** The drive will stop.

**Start Request:** Start Command to the drive.

B07: FALSE = No Action, TRUE = Fault Reset

**Fault Reset:** Resets active faults.

B10: FALSE = FB Control disabled TRUE = FB Control Enabled

**FB Control Disabled:** The drive will not follow the main control word from fieldbus. If removed while running, the drive will stop.

**FB Control Enabled:** The drive follows the control word from fieldbus.

B11: FALSE = FB WD Pulse Low, TRUE = FB WD Pulse High

**Watchdog pulse:** This pulse is used to monitor that PLC is alive. If the pulse is missing, the drive will go to FAULT state. This function is activated by P2.9.4.3 FB WD Delay. When the value is zero, the pulse is not monitored.

## 9.1 STATE MACHINE: VACON AFE 2

### 9.1.1 CONTROL WORD: VACON AFE 2 PROFILE (3)

FB Control Word ID1160		
	Signal	Comment
B00	DC Charge	0= Open MCB. 1= Close DC charge contactor, MCB closed automatically, see B01.
B01	MCB Close Enable	0= Disable Closing of MCB (Also opens if Control Options.B0=TRUE) 1= Enable Closing of MCB (Works also for reclosing)
B02	Quick Stop	0= Quick Stop 1= No Quick Stop
B03	Run	0= AFE is stopped 1= AFE is started
B04	Output Power Limit to Zero	0= Output Power Limit to Zero (1%) 1= Output Power Limit = P2.5.2.1
B05	Disable Power Increase. Input or Output	0= Disable increase of power. 1= Power limits defined by G2.5.2
B06	Input Power Limit to Zero	0= Input Power Limit to Zero (1%) 1= Output Power Limit = P2.5.2.2
B07	Reset	0>1 Reset fault.
B08		
B09		
B10	Fieldbus Control	0= No control from fieldbus 1=Control from fieldbus
B11	Watchdog	0>1>0>1...0,5 sec square wave clock. This is used to check data communication between fieldbus master and the drive.
B12	FB DIN2	Can be used to control RO or directly parameter by ID number. G2.4.1
B13	FB DIN3	Can be used to control RO or directly parameter by ID number. G2.4.1
B14	FB DIN4	Can be used to control RO or directly parameter by ID number. G2.4.1
B15		Reserved for future use.

Figure 16.

B00: FALSE = Open MCB, TRUE = PreCharge DC

**Open MCB:** Opens MCB if closed, stops precharging if charging is active trough the drive.

**PreCharge DC:** Drive will start precharge if function activated by digital output and control place is fieldbus. When control place is not fieldbus precharging is started from normal start command.

B01: MCB Close Enable

**FALSE:** MCB Closing is disabled in fieldbus control. MCB Remains open when if DC voltage is above closing limit.

**TRUE:** MCB Closing is enabled in fieldbus control. This bit can be true all the time if function is not needed.

B02: Quick Stop

**FALSE:** Drive will stop modulation immediately and open MCB immediately.

**TRUE:** Quick stop is not active and normal operation is possible.

B03: FALSE = Stop Request, TRUE = Start Request

**Stop Request:** Drive will stop .

**Start Request:** Start Command to the drive. Rising edge needed for start.

B04: Output Power Limit to Zero

**FALSE:** Output power limit is reduced to 1 % if parameter limit is higher.

**TRUE:** Power limit is defined by power limit parameters.

B05: Disable Power Increase. Input or Output

**FALSE:** Power is limited to actual power, power can't increase when this bit is active,

**TRUE:** Power limit is defined by power limit parameters.

B06: Input Power Limit to Zero

**FALSE:** Input power limit is reduced to 1 % if parameter limit is higher

**TRUE:** Power limit is defined by power limit parameters.

B07: FALSE = No significance, TRUE = Fault Acknowledge

**Fault Acknowledge:** The group signal is acknowledged with a positive edge.

B08: FALSE = No Function, TRUE = DC Ref 1

B09: FALSE = No Function, TRUE = DC Ref 2

DC Ref	FB Reference	110,00 %	115,00 %	120,00 %
B08	FALSE	TRUE	FALSE	TRUE
B09	FALSE	FALSE	TRUE	TRUE

B10: FALSE = FB Control disabled TRUE = FB Control Enabled

**FB Control Disabled:** Drive will not follow main control word from Fieldbus. If removed while running drive will make coasting stop.

**FB Control Enabled:** Drive follows control word from fieldbus

B11: FALSE = FB WD Pulse Low, TRUE = FB WD Pulse High

**Watch dog pulse:** This pulse is used to monitor that PLC is alive. If pulse is missing drive will go to fault state. This function is activated by P2.7.6 FB WD Delay. When value is zero pulse is not monitored.

## 9.2 FB STATUS WORD

FB Status Word ID68			
	FALSE	TRUE	Comment
b0	DC Charge Disabled	Ready to DC Charge	Drive own DC charge function disabled if FALSE
b1	Not ready to operate	Ready to operate	DC Charged and main CB closed.
b2	Not Running	Running	Drive in Run state
b3	No Fault	Fault	Fault Active
b4	Run Disabled	Run Enabled	Run Enable
b5	Quick stop active	Quick stop not active	Quick stop active
b6	CB Control OK	CB Control NOT OK	CB Requested open but DC stays high
b7	No Warning	Warning	Warning Active
b8	DC Act. <> DC Ref.	DC Act. = DC Ref.	DC at reference
b9	No FB Control request	FB Control Active	FB Control request accepted
b10	DC Below Limit	DC Above Limit	DC above set limit
b11	SW ID.Bit selection B11	P2.10.37 SW B11 ID.Bit	SW ID.Bit selection B11
b12	SW ID.Bit selection B12	P2.10.38 SW B12 ID.Bit	SW ID.Bit selection B12
b13	SW ID.Bit selection B13	P2.10.39 SW B13 ID.Bit	SW ID.Bit selection B13
b14	SW ID.Bit selection B14	P2.10.40 SW B14 ID.Bit	SW ID.Bit selection B14
b15	Watchdog feedback	Watchdog feedback	WD Feedback pulse

SM = Profibus board State Machine

B00: FALSE = DC Charge Disabled, TRUE = Ready to DC Charge

**DC Charge Disabled:** Fault active, CB requested open, for example, by "Open CB" Command or Quick Stop.

**DC Charge Enabled:** No fault active and no request to open CB.

B01: FALSE = Not Ready To Operate, TRUE = Ready To Operate

**Not Ready To Operate:** CB not closed or not allowed to close.

**Ready To Operate:** CB closed.

B02: FALSE = Drive is not operating, TRUE = Drive is operational

**Drive is not operating:** The drive is not in RUN state (not modulating)

**Drive is operational:** The drive is in RUN state and modulating.

B03: FALSE = No Fault, TRUE = Fault Present

**No Fault:** The drive is not on FAULT state.

**Fault Present:** The drive is in FAULT state.

B04: FALSE = Run Disabled, TRUE = Run Enabled

**Run Disabled:** The drive does not receive Run Enable command, for example from the Run Enable digital input.

**Run Enabled:** Run Command is enabled.

B05: FALSE = Quick Stop Activated, TRUE = Quick Stop Not Activated

**Quick Stop Activated:** Quick Stop command is active.

**Quick Stop Not Activated:** Quick stop command is not active.

B06: FALSE = CB Control OK, TRUE = CB Control Not OK

**CB Control OK:** CB control and the drive internal status are the same.

**CB Control Not OK:** The drive internal status to close the circuit breaker is high but the application logic requests for the circuit breaker to open. This can be the case when CB has been opened but DC is connected to battery system. DC must be discharged, or CB must close.

B07: FALSE = No Warning, TRUE = Warning Present

**No Warning:** There is no warning, or the warning has disappeared again.

**Warning Present:** The drive operates, but there is an active warning.

B08: FALSE = DC Voltage out of tolerance TRUE = DC Voltage within tolerance

**DC Error Out Of Tolerance Range**

**DC Error Within Tolerance Range**

B09: FALSE = No Control Requested, TRUE = Control Requested

**No Control Requested:** Control by the automation system is not possible, only possible at the device or by another interface.

**Control Requested:** The automation system is requested to assume control.

B10: FALSE = DC Not Reached, TRUE = DC Reached Or Exceeded

**DC Not Reached:** DC is below P2.5.7.2 DC Voltage Supervision Limit.

**DC Reached Or Exceeded:** DC is above P2.5.7.2 DC Voltage Supervision Limit.

B11: FALSE = SW ID.Bit selection B11, TRUE = SW ID.Bit selection B11

**SW ID.Bit selection B11 Low:** Selected bit is low.

**SW ID.Bit selection B11 High:** Selected bit is high.

B12: FALSE = SW ID.Bit selection B12, TRUE = SW ID.Bit selection B12

**SW ID.Bit selection B12 Low:** Selected bit is low.

**SW ID.Bit selection B12 High:** Selected bit is high.

B13: FALSE = SW ID.Bit selection B13, TRUE = SW ID.Bit selection B13

**SW ID.Bit selection B13 Low:** Selected bit is low.

**SW ID.Bit selection B13 High:** Selected bit is high.

B14: FALSE = SW ID.Bit selection B14, TRUE = SW ID.Bit selection B14

**SW ID.Bit selection B14 Low:** Selected bit is low.

**SW ID.Bit selection B14 High:** Selected bit is high.

B15: FALSE = FB DW Feedback Low, TRUE = FB DW Feedback High

**FB DW Feedback:** FB Control Word B11 is echoed back to the fieldbus. Can be used to monitor the communication status from the drive.



## 10. PROBLEM SOLVING

While proper information is needed from the problem, it is also recommended to try with latest application- and system software versions available. Software is continuously developed, and default settings are improved (See Chapter 1.13 Compatibility issues in parameters between versions).

Type	Signal Name	Actual	Unit	Mi
Value	Status Word	1890		0
Value	DC Voltage Act.	119,81	Decimal	
Value	Active Current	0,3	Binary	
Value	Reactive Current	0		
Value	Line Voltage GC	100,42		80,00
Value	Line Freq. GC	100		80,00
Value	Line State	38912		0
Value	Mindex	99,5	%	0,0

Figure 17. The recommended signals for NCDrive

Use the fastest communication speed (Baudrate: 57 600) and a 50 ms update interval for signals for the RS232 communication.

For the CAN communication, use a 1 Mbit communication speed and a 7 ms update interval for signals.

When you contact the support, send the \*.trn, \*.par and Service info (\*.txt) files with a description of the situation. If the situation is caused by a fault, take also the Datalogger data from the drive.

Note that Datalogger settings can be changed to catch correct situation and it is also possible to make manual force trig for Datalogger.

Before storing the parameter file, upload the parameters from the drive and save when NCDrive is in the ON-LINE state. If it is possible, do this while the problem is active.

It is also helpful to have a single line diagram from the system where problem is faced.

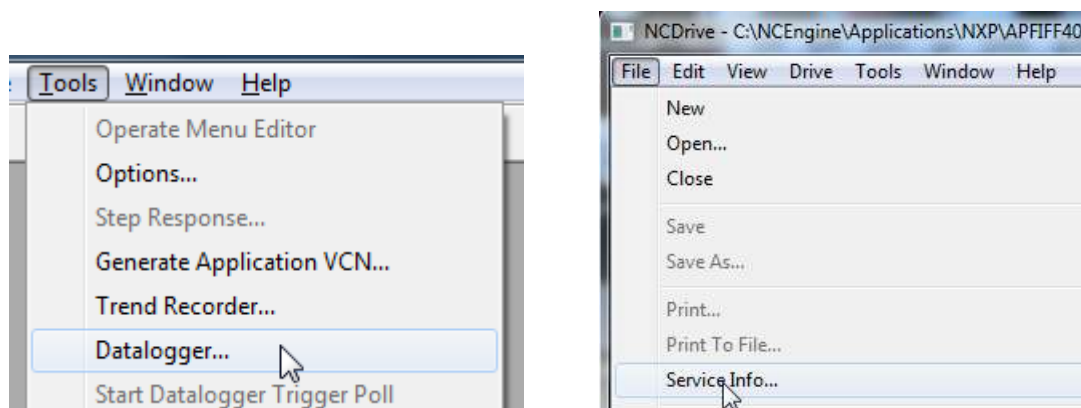

Figure 18. Datalogger window opening and Service Info upload.

## 11. COMMISSIONING

### 11.1 OPEN LOOP VOLTAGE COMPENSATION

Example from 2300 A 500 Vac unit

Index	Variable Text	Value	Unit	Min	Max	ID
P 2.1.1	Grid Nom.Voltage	400	V	n/a	n/a	110
P 2.2.8.1	Voltage at FWP	100,00	%	n/a	n/a	603
P 2.2.8.2	Field WeakngPnt	45,00	Hz	n/a	n/a	602
P 2.2.8.3	VoltageCorrection	-5	V	n/a	n/a	1790
P 2.2.8.4	Capacitor Size	6,3	%	n/a	n/a	1460
P 2.2.8.5	Inductor Size	16,5	%	n/a	n/a	1461
P 2.2.8.6	Inductor Losses	19,5	%	n/a	n/a	1465
P 2.11.3	Voltage Droop	4,50	%	n/a	n/a	1535

System had two grid converter and three diesel generators working in parallel.

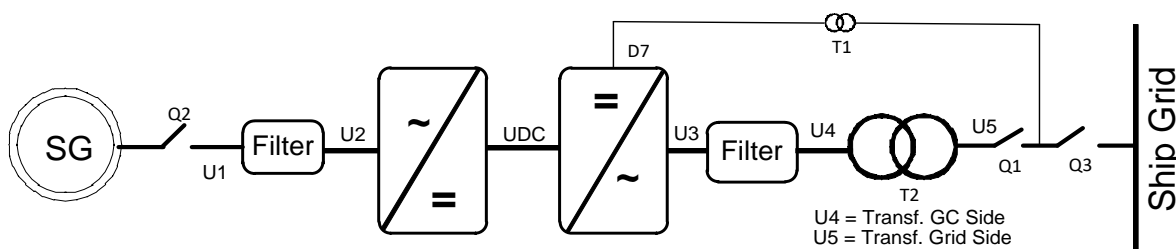

First Voltage Droop and Frequency Droop are set to the same values as the diesel generators on the ship's grid.

#### 11.1.1.1 PARAMETERS AFFECT

Grid Nom. Voltage: 400 Vac, Reactive Current: 30 %, Active Current 50 %, Inductor Size: 15 %, Inductor Losses: 15 %, Voltage Correction: 0 Vac.

Reactive Increase:  $400 \text{ Vac} \times 30 \% \times 15 \% = 18 \text{ Vac}$

Active Increase:  $400 \text{ Vac} \times 50 \% \times 15 \% \times 15 \% = 4,5 \text{ Vac}$

Total increase:  $18 \text{ Vac} + 4,5 \text{ Vac} = 22,5 \text{ Vac} \rightarrow \text{Drive Supply Voltage} = 422,5 \text{ Vac}$

Usually reactive current should stay on negative side. If reactive current is on positive side, voltage from other power sources is higher than what drive voltage is, or Grid Converter voltage is too low compared to grid voltage. If reactive current is higher negative value than other power sources, voltage reference or voltage losses compensation is too high in grid converter.

Look for actual voltage, not the voltage that is "on paper".

### 11.1.2 NO LOAD TUNING

Tuning is started from Voltage Correction parameter, using Inductor Size 5,0 % and Inductor Losses 10,0 %. System is started with Q3 open so that existing grid does not affect no-load values. Reactive current will be usually about -5 %, this will count +3 Vac based on Inductor Size ( $400 \text{ Vac} * 15 \% * 5 \%$ ) and -0,9 Vac based on Voltage Droop ( $400 \text{ Vac} * 5 \% * 4,5 \%$ ). Adjust Voltage Correction parameter so that pOPT-D7 measurement on average is 400 Vac (But practically the voltage when other power sources are creating the grid).

### 11.1.3 TUNING WITH LOAD

After this, depending on system, there are several ways to tune Inductor Side and Inductor Losses. First Inductor Size needs to be tuned because Inductor Losses parameter is percentage value from Inductor Size.

When running parallel Reactive Current needs to be negative value, if positive Grid Converter voltage is too low.

#### 11.1.3.1 Tuning on the fly

Most cases tuning is done when running in parallel with other power sources. In this case look for Cos Phii or reactive power of generators. Tune inductor size so that all power sources has the same Cos Phii. If Cos Phii is not available use kVar values in percentage. i.e. see that all power sources have same percentage value of kVar.

Active current causes additional voltage losses (More current over LCL) and this is compensated with Inductor Losses parameter in the same way as Inductor Size was tuned.

#### 11.1.3.2 Tuning with load bank

Tuning with load bank is easiest, not only because kW and KVar values can be adjusted to desirable level but you will have diesel generator testing data available in most cases.

First set drooping values to zero or use Island mode. Note that to do this Grid Converter needs to be only power source for the load bank. Now without drooping, first tune Inductor Size with different kVar load so that voltage stays the same at all load. When inductor size is tuned set kVar to maximum and start to increase active load and tune Inductor Losses so that voltage stays constant at all loads. You may need to do this a couple of times to tune out cross affects between Voltage Correction, Inductor Size and Inductor Losses.

Now drooping for frequency and voltage can be activated, repeat above kVar and kW steps and compare these results to generator test data. Note that drooping values may need to be different than the value used in generators not that inductor values are wrong.

#### 11.1.3.3 Tuning against strong grid

Tuning against strong grid could mean that other power sources voltage drooping is disabled. i.e. generator will keep the same voltage regardless of kVar load. Or tuning is done against national grid where natural voltage drop is minimal.

First set drooping values. And then tune Voltage Correction so that Reactive Current is zero while also Active Current is zero. Now if your voltage drooping is 4,5 % increase voltage by half of this (e.g. with FWPV), in this state reactive current should be 50 %. Note that drive Reactive Current is scaled

to SystemRatedCurrent as is Active Current. If not 50 %, tune Inductor Size accordingly. Check Reactive Current with different voltage levels if possible.

Tune Inductor losses while keeping e.g. 50 % Reactive Current and increase Frequency Droop offset by half of Frequency Droop, if grid can take this power, active current should be also 50 %. Note that especially when running against generator this may not be possible because actual power is determined by grid demand. If Reactive Current has changed from zero active current situation tune Inductor Losses that original Reactive Current level is reached.

Reset offset from parameters and test operation when drooping is enabled in all power sources that are parallel and tune Voltage Correction that all power sources share kVar correctly.

#### 11.1.4 CLOSED LOOP VOLTAGE CONTROL

OPT-D7 can be used to control the grid voltage. But it's recommended to make open loop tuning in case of measurement failure in OPT-D7 board. Grid Voltage PI Group has limits for OPT-D7 voltage and frequency; if these limits are exceeded control will fall back to open loop voltage control.

Index	Variable Text	Value	Unit	Min	Max	ID
P 2.16.1	PID Activation	DigiN:0.1		n/a	n/a	1807
P 2.16.2	PID-Contr Gain	200,0	%	n/a	n/a	118
P 2.16.3	PID-Contr I Time	0,05	s	n/a	n/a	119
P 2.16.4	PI Max Adjust +-	5,00		n/a	n/a	360
P 2.16.5.1	PI Freq Low Lim	95,00	%	n/a	n/a	1630
P 2.16.5.2	PI Freq High Lim	102,00	%	n/a	n/a	1631
P 2.16.5.3	PI Volt Low Lim	90,00	%	n/a	n/a	1632
P 2.16.5.4	PI Volt High Lim	110,00	%	n/a	n/a	1633

## 12. FAULT CODES

This chapter includes all the fault codes. However, some faults are not possible in the AFE mode. With other faults, the description can be different when compared to a standard AC drive.

### *F1 Over current fault*

The drive has detected a high current in the output phase.

S1 = Hardware trip.

Current above  $4 \cdot I_h$

S3 = Current controller supervision.

Current limit too low or current peak value too high.

#### Possible cause

- Sudden change in grid frequency.
- Sudden change in grid voltage.
- Short circuit in grid while Short Circuit function is not active.

#### Correcting measures

- Check grid conditions load.
- Activate Short Circuit function.

### *F2 Overvoltage fault*

DC link voltage has exceeded the drive protection limits.

S1 = Hardware trip.

500 Vac unit DC voltage above 911 Vdc

690 Vac unit DC voltage above 1200 Vdc

S2 = Overvoltage control supervision (only 690 Vac unit).

DC voltage has been above 1100 Vdc for too long.

#### Possible cause and solutions

- Sudden change in supply voltage or frequency.
- Unstable DC power source in uGrid mode.
- Wrong Grid frequency.

#### Correcting measures

- Check supply voltage.
- Check DC source.
- Check grid conditions.

### ***F3 Earth fault***

Earth fault protection makes sure that the sum of the motor phase currents is 0. The over current protection is always working and protects the AC drive from earth faults with high currents.

S1 = Sum of output phase current is not zero.

#### **Possible cause**

- No transformer on the input/output side.
- Insulation failure.

#### **Correcting measures**

- Contact factory.

### ***F5 Charge switch***

Charge switch status is not correct when the start command is given.

S1 = Charge switch was open when the start command was given.

#### **Possible cause**

- Charge switch was open when the start command was given.
- Reset the fault and restart.

#### **Correcting measures**

- Check the connection of the feedback from charging relay
- If the fault re-occurs, contact your local distributor.

### ***F6 Emergency stop***

Emergency stop command has been given by using a special option board.

### ***F7 Saturation fault***

S1 = Hardware failure.

#### **Possible cause and solutions**

#### **Correcting measures**

- Check the isolation resistance and the resistance on the brake resistor.
- Check the capacitors.

## ***F8 System Fault***

A system fault indicates that there are several different fault situations in the drive operation.

S1 = Reserved

- Disturbance. Reset the unit and try again.
- If there is star coupler in the unit, check the fibre connections and phase order.
- Driver board or IGBT is broken.
- FR9 and the bigger drives, which includes not star coupler, ASIC board (VB00451), is broken.
- FR8 and smaller drives: control board is broken.
- FR8 and smaller drives: if there are boards VB00449 / VB00450, the fault can be there.

S2 = Reserved

S3 = Reserved

S4 = Reserved

S5 = Reserved

S6 = Reserved

S7 = Charge switch

S8 = No power to driver card

S9 = Power unit communication (TX)

S10 = Power unit communication (Trip)

S11 = Power unit comm. (Measurement)

S12 = SystemBus synchronisation has failed in DriveSynch operation

S30 = Safe disable inputs are in different state (OPT-AF)

S31 = Thermistor short circuit detected (OPT-AF)

S32 = OPT-AF board has been removed

S33 = OPT-AF board EEPROM error

### **Possible cause and solutions**

### **Correcting measures**

### ***F9 Undervoltage fault***

DC link voltage is below the fault voltage limit of the drive.

S1 = DC link too low during the run.

S2 = No data from the power unit.

S3 = Undervoltage control supervision.

#### **Possible cause**

- Too low a supply voltage.
- AC drive internal fault.
- One of the input fuses is broken.
- External charge switch has not been closed.

#### **Correcting measures**

- In case of temporary supply voltage break, reset the fault and restart the AC drive.
- Check supply voltage.
- Check the operation of the DC charge.
- Contact your local distributor.

### ***F10 Line Synchronization Fault***

S1 = Phase supervision diode supply. (Input phase fault, disabled)

S2 = Phase supervision active front end. (Line Synch Fault)

S3 = Grid Converter operation, frequency outside frequency limits (G2.6.3).

#### **Possible cause:**

- No grid to be synchronized or phases missing
- Slow power increase in a grid and limit controllers has activated.
- Power or current limits too low for the active load.

#### **Correcting measures**

- Check supply voltage, fuses and cable.
- Check drive dimensioning against grid power requirements.
- Check that power or current limits are sufficient.

### ***F11 Line phase supervision***

#### **Possible cause:**

- Current measurement has detected that there is no current in one phase, or one phase current is considerably different from other phases.

#### **Correcting measures**

- Check the line cable and the fuses.



### *F12 Brake chopper supervision*

Brake chopper supervision generates pulses to the brake resistor for response. If no response is received within set limits, a fault is generated.

Possible cause:

- No brake resistor is installed.
- The brake resistor is broken.
- Brake chopper failure.

Correcting measures:

- Check the brake resistor and the cabling.
- If these are ok, the chopper is faulty. Contact your local distributor.

### *F13 Drive undertemperature fault*

Possible cause:

- Heatsink temperature is under  $-10^{\circ}\text{C}$

Correcting measures:

- Add cabinet heater to prevent too cold temperatures and condensation.

### *F14 Drive overtemperature fault*

Possible cause:

- Heatsink temperature is above the acceptable limits. See the user manual for the temperature limit. Overtemperature warning is issued before the actual trip limit is reached.

Correcting measures

- Check correct amount and flow of cooling air.
- Check the heatsink for dust.
- Check ambient temperature.
- Make sure that switching frequency is not too high in relation to ambient temperature and motor load.

### *F22 EEPROM checksum fault*

Possible cause:

- Parameter save fault.
- Faulty operation.
- Component failure.

Correcting measures:

- If the fault re-occurs, contact your local distributor.

*F24 Counter fault*

Possible cause:

- Values displayed on the counters are incorrect.

Correcting measures:

- Have a critical attitude towards values shown on the counters.

*F25 Microprocessor watchdog fault*

Possible cause:

- Start-up of the drive has been prevented.
- Run request is ON when a new application is loaded to the drive.

Correcting measures:

- Reset the fault and restart.
- If the fault re-occurs, contact your local distributor.

*F26 Start-Up prevention*

Possible cause:

- Start-up of the drive has been prevented.
- Run request is ON when a new application is loaded to drive

Correcting measures:

- Cancel the prevention of the start-up if this can be done safely.
- Remove Run Request.

*F29 Thermistor fault*

The thermistor input of the option board has detected too high a motor temperature.

Possible cause:

- LCL is overheated.
- Thermistor cable is broken.

Correcting measures:

- Check LCL cooling and load.
- Check thermistor connection (If thermistor input of the option board is not in use it has to be short circuited).

### *F31 IGBT temperature Hardware*

IGBT Inverter Bridge overtemperature protection has detected too high a short term overload current.

Possible cause:

- Too high a load.
- Identification run has not been made, which causes the motor to start undermagnetised.

Correcting measures:

- Check the load.
- Check the motor size.
- Make an Identification Run.

### *F32 Fan cooling*

Possible cause:

- Cooling fan of the AC drive does not start when ON command is given.

Correcting measures:

- Contact your local distributor.

### *F37 Device change*

Option board or power unit is changed.

Possible cause:

- New device of same type and rating.

Correcting measures:

- Reset. The device is ready for use.

### *F38 Device added*

Option board is added.

Correcting measures:

- Reset. The device is ready for use. Old board settings will be used.

### *F39 Device removed*

Possible cause:

- Option board is removed.

Correcting measures:

- Reset. The device is no longer available.

**F40** *Device unknown*

An unknown option board or drive.

S1 = Unknown device.

S2 = Power1 not same type as Power2.

Correcting measures:

- Contact your local distributor.

**F41** *IGBT temperature Software*

IGBT inverter bridge overtemperature protection has detected too high a short term overload current.

Correcting measures:

- Check the load.
- Check the motor size.
- Make an Identification Run.

**F42** *Brake resistor overtemperature*

S1: Brake resistor high temperature.

Calculation for an internal brake resistor has exceeded the tripping limit. If the internal brake resistor is not in use, set the brake chopper parameter in System menu to *Not connected*.

S2: Brake resistor resistance is too high.

S3: Brake resistor resistance is too low.

S4: No brake resistor detected.

**F44** *Device changed (Default param.)*

Possible cause:

- Option board or power unit is changed.
- New device of different type or different rating from the previous one.

Correcting measures:

- Reset.
- Set the option board parameters again if option board was changed. Set the drive parameters again if the power unit was changed.

**F45** *Device added (default param.)*

Possible cause:

- Option board of different type added.

Correcting measures:

- Reset.
- Set the option board parameters again.

*F50 4mA supervision*

Possible cause:

- Current at the analogue input is below 4mA.
- Signal source has failed.
- Control cable is broken or loose.

Correcting measures:

- Check the current loop circuitry.

*F51 External fault*

Possible cause:

- Digital input fault.

Correcting measures:

- Remove fault situation from the external device.

*F52 Keypad communication*

Possible cause:

- The connection between the control panel (Keypad) or NCDrive and the AC drive is broken.

Correcting measures:

- Check control panel connection and possible control panel cable.

*F53 Fieldbus communication fault on slot D*

Possible cause:

- The data connection between the fieldbus Master and the fieldbus board is broken.
- Watchdog pulse is missing from PLC, if Control Slot selector is 0, or set for slot D.

Correcting measures:

- Check installation.
- If installation is correct, contact your local distributor.

*F54 Slot fault*

Possible cause:

- Defective option board or slot.

Correcting measures:

- Check the board and the slot.
- Contact your local distributor.

### ***F55 Input Switch***

Possible cause:

1. Digital input monitoring indicates that DC or AC input switch is open

Correcting measures:

- Check reason for open input switch.

### ***F56 PT100 temperature fault***

The PT100 protection function is used to measure temperature and give a warning and/or a fault when the set limits are exceeded. The marine application supports two PT100 boards. One can be used for the motor winding and the other for the motor bearings.

Possible cause:

- Temperature limit values set for the PT100 board parameters have been exceeded.

Correcting measures:

- Find the cause of temperature rise.

### ***F57 Identification***

Identification run has failed.

Possible cause:

- There was load on the motor shaft when making the identification run with a rotating motor.
- Motoring or generator side torque/power limits are too low to achieve a stable run.

Correcting measures:

- Run command was removed before the identification was ready.
- Motor is not connected to the AC drive.
- There is load on the motor shaft.

### ***F58 Mechanical brake***

This fault is generated when the acknowledge signal from the brake is used. If the status of the signal is opposite from the control signal for a longer period of time than the delay defined with P2.15.11 *Brake Fault Delay*, a fault is generated.

Correcting measures:

- Check the condition and connections of the mechanical brake.

### ***F60 Cooling***

Protection for the liquid-cooled units. An external sensor is connected to the drive (DI: Cooling Monitor) to indicate if cooling liquid is circulating. If the drive is in STOP state, only a warning is issued. In RUN state a fault is issued and the drive makes a coast stop.

**Possible cause:**

- The cooling circulation of a liquid-cooled drive has failed.

**Correcting measures:**

- Check reason for cooling failure from the external system.

### ***F62 Run Disabled***

A Run Disable warning signal is issued when a Run Enable signal has been removed from the I/O.

### ***F63 Quick stop***

**Possible cause:**

- A command has been given from a digital input or the fieldbus to make a quick stop.

**Correcting measures:**

- A new run command is accepted after the quick stop is reset.

### ***F64 MCB State Fault***

This function monitors the MCB status. Feedback status should correspond to the control signal. The delay to fault is defined by P2.9.1.13 MCB Fault Delay for A2 and A3. A4 is immediately.

A1: Code given by V084 and older versions.

A2: MCB open while request is to close.

A3: MCB closed while request is to open.

A4: MCB opened externally while AFE unit was in run state.

**Possible cause:**

- Main circuit breaker has opened while drive controls it to close.
- Main circuit breaker has closed while drive controls it to be open.

**Correcting measures:**

- Check the main circuit breaker function.

### ***F65 PT100 board 2***

The PT100 protection function is used to measure temperature and give a warning and/or a fault when the set limits are exceeded. The marine application supports two PT100 boards. One can be used for the motor winding and the other for the motor bearings.

Possible cause:

- The temperature limit values set for the PT100 board parameters have been exceeded.
- The number of inputs selected is higher than what is actually connected.
- PT100 cable is broken.

### *F66 Klixon*

Possible cause:

1. Klixon type temperature sensor has exceeded the triggering limit.

Correcting measures:

- Check reason for temperature trip where klixon sensor is located.

### *F67 Fieldbus communication fault on slot E*

Possible cause:

- The data connection between the fieldbus Master and the fieldbus board is broken.
- Watchdog pulse is missing from PLC, if Control Slot Selector is 0, or set for slot E.

Correcting measures:

- Check installation.
- If installation is correct contact your local distributor.

### *F68 D7 Voltage or frequency fault*

This monitors Grid frequency and voltage for external grid synchronization function. Warning is given when request to synchronize is given and voltage and/or frequency is out of the warning limits defined in G2.9.6 and G2.9.7 voltage and frequency warning limits.

Possible cause:

- OPT-D7 measurements are not within limits.

### *F69 OPT-D7 Missing*

OPT-D7 board is not present for the function that is requested.

Possible cause:

Correcting measures:

### *F70 Supply Voltage*

Supply voltage is not inside of set hysteresis. Not to be confused with OPT-D7 protections.

### *F71 LCL Temperature*

LCL Temperature has reached the warning limit.



Possible cause:

Correcting measures:

### *F72 License*

Licence has not been given or licence key is wrong. See also V1.6.2 and V1.6.3 for more information about license code status.

S2 = Common license fault.

S3 = Grid Converter License

S4 = Master-Follower License

S5 = Grid Code license

Possible cause:

- Wrong license code.
- Wrong code entered too many times wrong.
- System software V196 or older may give fault after long period of working, recommended to update system software to V197 or newer.

Correcting measures:

- Check that you have correct license code
- Boot control unit if wrong code entered too many times.
- Update system software to V197 or newer.

### *F73 Supply Frequency*

Supply frequency is not inside of set hysteresis, set in G2.9.7. Not to be confused with OPT-D7 protections that will give F93 D7 Frequency.

Possible cause:

- Slow power increase in a grid and limit controllers activated.
- Power or current limits too low for the active load.
- Not sufficient DC voltage to keep grid voltage, compensated by lowering Supply Frequency to avoid reactive current.

Correcting measures

- Check drive dimensioning against grid power requirements.
- Check that power or current limits are sufficient.
- Check that sufficient DC voltage is available for the unit.

### *F77 DC Ground Fault*

Digital input indicated that system has a DC Ground Fault

Possible cause:

- Digital input has triggered DC Ground Fault indication in the drive.

Correcting measures

- Check reason for DC Ground Fault indication.

### *F80 Charging Fault*

The drive has not reached the required DC voltage at time set to MCB.

Possible cause:

- Charging circuit not operational.
- High load in DC link.
- Low voltage in supply for charging circuit.

Correcting measures:

- Check charging current

### *F81 External Fault 2*

Digital input fault.

Possible cause:

Correcting measures:

- Remove fault situation from external device.

### *F83 Over Load*

Over Load protection has reached tripping limit. See Chapter 5.9.9 Over Load Protection.

### *F88 Ambient temperature*

Possible cause:

1. Temperature sensor has detected too high ambient temperature

Correcting measures:

1. Check reason for high ambient temperature on location where sensor is located.

### *F89 Grid Side Fault*

In Master-Follower Mode Grid side drive has an active fault that is shown in master drive as a fault.

Possible cause:

Correcting measures:

### *F91 Short Circuit*

Drive has operated against current limit for more than short circuit time.

By phase fault detection has seen low voltage for more than short circuit time.

Warning comes immediately when current is at current limit, fault comes after the short circuit time.

A1: Code given by V089 and older versions.

A2: Bi Phase

A3: Three Phase

Possible cause:

- There is a short circuit in the grid.

Correcting measures:

### *F92 D7 Voltage*

Measured voltage is not within limits set in the protection group Grid Voltage D7

Possible cause:

- Voltage reference is below set limit.
- Supply Voltage is below set limit.
- There is a short circuit in the grid.
- OPT-D7 is installed but not connected.
  - Monitoring can be disabled with Control Options.

### *F93 D7 Frequency*

Measured frequency is not within limits set in protection group Grid Frequency.

Possible cause:

- OPT-D7 is installed but measurements are not connected.
  - Monitoring can be disabled with Control Options.
- Grid frequency has gone outside the set limits.

### *F95 Grid Code*

Grid Code tripping limit has been reached.

- A2: Line Voltage High Level 1
- A3: Line Voltage High Level 2
- A4: Line Voltage Low Level 1
- A5: Line Voltage Low Level 2
- A6: Line Frequency High Level 1
- A7: Line Frequency High Level 2
- A8: Line Frequency Low Level 1
- A9: Line Frequency Low Level 2
- A10: LVRT Three Phase trip.
- A11: LVRT Bi-Phase trip
- A12: Separate limits or forced trip
- A13: Line Frequency change rate trip.
- A14: 10 Min Average high voltage trip
- A16: Line Voltage High 3 Trip
- A17: Line Voltage Low 3 Trip
- A18: Line Frequency High 3 Trip
- A19: Line Frequency Low 3 Trip
- A20: Anti-Islanding Trip
- A21: Bi-Phase High Voltage 1 Trip
- A22: Bi-Phase High Voltage 2 Trip
- A23: Bi-Phase High Voltage 3 Trip
- A24: Bi-Phase Low Voltage 1 Trip
- A25: Bi-Phase Low Voltage 2 Trip
- A26: Bi-Phase Low Voltage 3 Trip
- A27: Line Voltage Low 4 Trip
- A28: Bi-Phase Low Voltage 4 Trip

# VAGON<sup>®</sup>

[www.danfoss.com](http://www.danfoss.com)

Vacon Ltd  
Member of the Danfoss Group

Runsorintie 7  
65380 Vaasa  
Finland

Document ID:



Rev. A