

VACON

DRIVEN BY DRIVES



X5 AC DRIVE

USER'S MANUAL

Need Help?

This manual answers most installation and startup questions that may arise. However, if you have any problems, please let your first call be to us.

Vacon, Inc.
Chambersburg, PA 17202

Normal business hours:
(North America)

8:00 AM to 5:00 PM, Eastern time
+1 877-Vacon06
(+1 877-822-6606)

After-hours support is also available

 and Vacon, Inc. are trademarks of Vacon Plc, a member of Vacon Group. All other product names are trademarks of their respective companies.

Copyright 2009, Vacon, Incorporated. All rights reserved.

█ = cannot change in Run
Bold type = Level 1 parameter

Summary of X5 Parameters

No.	Parameter Name	Options	Default	User Setting	See Page
001	Model Number	Model dependent	Read-only		71
002	Software Rev	0.00-99.99	Read-only		71
003	Rated Current	0.0-200.0 A	Read-only		71
005	Serial No. 1	0-65535	Read-only		71
006	Serial No. 2	0-65535	Read-only		71
007	USB Soft. Rev	0.00 - 99.99	Read-only		71
008	Option Installed	text string	Read-only		71
009	Fbus Soft. Rev	0.00 - 99.99	Read-only		71
030	Pwr Down Date	dd/mm/yy	Read-only		71
031	Pwr Down Time	Dd/hh/mm (Dd = Tu, Th, etc.)	Read-only		72
102	Output Freq	0.0-400.0 Hz	Read-only		72
103	Output Voltage	0-600 V	Read-only		72
104	Output Current	0.0-200.0 A	Read-only		72
105	Drive Load	-200.0-200.0%	Read-only		72
106	Load Torque	-200.0-200.0%	Read-only		72
107	Drive Temp	-20.0-200.0 °C	Read-only		72
108	Total Run Time	0.0-6553.5 h	Read-only		72
109	Power On Hours	0-65535 h	Read-only		72
110	Stator Freq	0.0-400.0 Hz	Read-only		72
111	DC Bus Voltage	0 - 1000 Vdc	Read-only		72
115	Drive Power Out	0.0-200.0%	Read-only		72
116	Out Power (kW)	0.0 - 327.67	Read-only		72
117	MWh Meter	0 - 32767	Read-only		72
118	kWh Meter	0.0 - 999.9	Read-only		72
120	Today's Date	MM/dd/YY	Read-only		73
121	Today's Time	hh:mm	Read-only		73
150	Show Clock Parameters (Parameters 151-179)	text string	0 (No)		73
151	Tiime Zone Setup	text string	12 (-5 East. US)		73
152	TOD Run Enable	0-23 hours, 0-59 min	12:00		73
154	TOD Run Disable	0-23 hours, 0-59 min	12:00		73
156	TOD Run En 2	0-23 hours, 0-59 min	12:00		73
158	TOD Run Dis 2	0-23 hours, 0-59 min	12:00		74
160	Weekend TOD En	0-23 hours, 0-59 min	12:00		74
162	Weekend TOD Dis	0-23 hours, 0-59 min	12:00		74
171	Reminder 1 Conf.	text string	0 (disabled)		74
172	Reminder 1 Time	1-32000 hours	1		74
173	Reminder 1 ETA	+/- 32000 hours	Read-only		74
174	Reminder 2 Conf.	text string	0 (disabled)		74
175	Reminder 2 Time	1-32000 hours	1		74
176	Reminder 2 ETA	+/- 32000 hours	Read-only		74
177	Reminder 3 Conf.	text string	0 (disabled)		75
178	Reminder 3 Time	1-32000 hours	1		75
179	Reminder 3 ETA	+/- 32000 hours	Read-only		75
201	Input Mode	text string	Local Only		75
202	Rev Enable	text string	Forward		75
203	Stop Key Remote	text string	Coast		76
204	Ref Select	text string	Vin1		76
205	Vin1 Config	text string	0-10V		77
206	Vin1 Offset	0.0% to 100.0%	0.00%		77

Note that all parameters can be addressed by adding 40000 to the parameter number. For example, parameter 201 (Input Mode) can be addressed by Modbus address 40201.

= cannot change in Run
Bold type = Level 1 parameter

No.	Parameter Name	Options	Default	User Setting	See Page
207	Vin1 Span	10.0% to 200.0%	100.00%		77
208	Cin Config	text string	0-20mA 50		77
209	Cin Offset	0.0% to 100.0%	0.0%		77
210	Cin Span	10.0% to 200.0%	100.0%		78
211	Vin2 Config	text string	0-10V		78
212	Vin2 Offset	0.0% to 100.0 %	0.00%		78
213	Vin2 Span	10.0% to 200.0%	100.00%		78
214	Vin1 Filter Time	0 to 1000 ms	20 ms		78
215	Cin Filter Time	0 to 1000 ms	20 ms		78
216	Vin2 Filter Time	0 to 1000 ms	20 ms		78
217	Trim Ref Enable (Set k-Factor)	text string	0		78
218	Trim % Factor	-100.0 - 100.0%	0.0%		79
222	Ref Loss Config	text string	No Fault		79
301	Min Frequency	0.0 - Max Freq.	0.0 Hz		79
302	Max Frequency	20.0 - 400.0 Hz	60.0 Hz		79
303	Preset Freq 1	Min Freq-Max Freq	5.0 Hz		79
304	Preset Freq 2	Min Freq-Max Freq	10.0 Hz		79
305	Preset Freq 3	Min Freq-Max Freq	20.0 Hz		79
306	Preset Freq 4	Min Freq-Max Freq	30.0 Hz		79
307	Preset Freq 5	Min Freq-Max Freq	40.0 Hz		79
308	Preset Freq 6	Min Freq-Max Freq	50.0 Hz		79
309	Cut-off Freq	0.0 - 5.0 Hz	0.0 Hz		79
310	Preset Freq 7	Min Freq-Max Freq	60.0 Hz		79
311	Preset Freq 8	Min Freq-Max Freq	0.0 Hz		79
312	Preset Freq 9	Min Freq-Max Freq	2.5 Hz		79
313	Preset Freq 10	Min Freq-Max Freq	7.5 Hz		79
314	Preset Freq 11	Min Freq-Max Freq	15.0 Hz		79
315	Preset Freq 12	Min Freq-Max Freq	25.0 Hz		79
316	Preset Freq 13	Min Freq-Max Freq	35.0 Hz		79
317	Preset Freq 14	Min Freq-Max Freq	45.0 Hz		79
318	Preset Freq 15	Min Freq-Max Freq	55.0 Hz		79
380	Keeper Input Cfg	text string	4 (disabled)		79
381	Keeper Max Scale	0-32000	1000		80
382	Keeper Save Time	00:00 - 23:59	0:00		80
384	Keeper Save Rate	text string	0 (24 hour)		80
385	Keeper Input Value	0-32000	Read-only		80
386	Keeper Time Rate	text string	1 (minute)		80
387	Keeper Rec. Num	0-255	Read-only		80
388	Active Kpr. Record	0-255	Read-only		80
389	Keeper Units	text string	1 (GPM)		81
401	Ramp Select	text string	ART-DI		81
402	Accel Time 1	0.1-3200.0 sec	5.0 sec		81
403	Decel Time 1	0.1-3200.0 sec	5.0 sec		81
404	Accel Time 2	0.1-3200.0 sec	3.0 sec		82
405	Decel Time 2	0.1-3200.0 sec	3.0 sec		82
406	DC Inject Config	text string	DC at Stop		82
407	DC Inject Time	0.0-5.0 sec	0.2 sec		82
408	DC Inject Level	0.0% to 100.0%	50.0%		82
409	DC Inj Freq	0.0 to 20.0 Hz	0.0 Hz		82
410	DB Config	text string	Internal		83
414	S Ramp Rounding	1 - 100%	25%		83

Note that all parameters can be addressed by adding 40000 to the parameter number. For example, parameter 201 (Input Mode) can be addressed by Modbus address 40201.

= cannot change in Run
Bold type = Level 1 parameter

No.	Parameter Name	Options	Default	User Setting	See Page
415	Accel Time 3	0.1-3200.0 sec	10.0 sec		83
416	Decel Time 3	0.1-3200.0 sec	10.0 sec		83
417	Accel Time 4	0.1-3200.0 sec	15.0 sec		84
418	Decel Time 4	0.1-3200.0 sec	15.0 sec		84
490	App Macro	text string	Factory		84
491	Seq Appl	text string	Disabled		84
492	SIO Visible	text string	No		84
501	V/Hz Select	text string	Linear Fixed		85
502	Voltage Boost	0.0-50%	1.0%		85
503	V/Hz Knee Freq	25.0-400.0 Hz	60.0 Hz		85
504	Skip Freq Band	0.2-20.0 Hz	0.2 Hz		86
505	Skip Freq 1	Min Freq-Max Freq	0.0 Hz		86
506	Skip Freq 2	Min Freq-Max Freq	0.0 Hz		86
507	Skip Freq 3	Min Freq-Max Freq	0.0 Hz		86
508	Skip Freq 4	Min Freq-Max Freq	0.0 Hz		86
509	Rated Mtr Volt	100V-690V	Model dependent		86
510	Rated Mtr FLA	50% - 200% of ND Rating	ND Rating		86
511	Rated Mtr RPM	0-24000 rpm	1750 rpm		86
512	Midpoint Freq	0.0 Hz-V/Hz Knee Freq	60.0 Hz		86
513	Midpoint Volt	0.0-100.0%	100.0%		86
514	Motor RS	0.0-655.35 Ohms	Model dependent		86
515	Power Factor	0.50-1.00	0.80		86
516	Slip Comp Enable	text string	No		87
517	Single Phase	text string	No		87
519	Find Mtr Data	Not active / Motor RS	Not active		87
520	Filter FStator	1 - 100 ms	8 ms		87
521	Start Field En	text string	No		87
522	Filter Time Slip	10 - 1000 ms	100 ms		88
523	Id Percent	0 - 200%	Read-only		88
524	Iq Percent	0 - 200%	Read-only		88
525	Power Fail Config	text string	CTS No Msg		88
526	UV Ride-Thru En	text string	w/ LVT		88
600	Current Lim Sel	text string	0		89
601	Cur Lim Mtr Fwd	5%-150%	120%		89
602	Cur Lim Mtr Rev	5%-150%	120%		89
603	Cur Lim Reg Fwd	5%-150%	80%		89
604	Cur Lim Reg Rev	5%-150%	80%		89
605	Cur Lim Freq	0.0 - 400.0 Hz	3.0 Hz		89
606	Ramp Time CL	0.1-3200.0 sec	1.0 sec		89
607	Cur Limit Minimum	0 - 50%	10%		89
608	Restart Number	text string	0		90
609	Restart Delay	0-60 sec	60 sec		90
610	Timed OL Select	text string	0 (Std Ind 60s)		90
613	Max Regen Ramp	100 - 1000%	300%		91
614	Stability Gain	0 - 10	Model Dependent		91
615	Stability Rate	0 - 1000	Model Dependent		91
700	Vmet Config	text string	Freq Out		91
701	Vmet Span	0.0-200.0%	100.0%		91
702	Imet Config	text string	Drive Load		92
703	Imet Span	0.0-200.0%	100.0%		92
704	Imet Offset	0.0-90.0-%	0.0%		92

Note that all parameters can be addressed by adding 40000 to the parameter number. For example, parameter 201 (Input Mode) can be addressed by Modbus address 40201.

= cannot change in Run
Bold type = Level 1 parameter

No.	Parameter Name	Options	Default	User Setting	See Page
705	Relay 1 Select	text string	1 (Drv Fault)		93
706	Relay 2 Select	text string	2 (Drive Run)		93
707	DO1 Select	text string	0 (Drv Ready)		93
708	DO2 Select	text string	6 (At Speed)		93
719	Digital Input Filter Time	1-1000 msec	5 msec		94
720	Active Logic	text string	1 (Active High)		94
721	DI1 Configure	text string	0 (Preset 1)		95
722	DI2 Configure	text string	1 (Preset 2)		95
723	DI3 Configure	text string	2 (Preset 3)		95
724	DI4 Configure	text string	6 (Alt Ramp)		95
725	DI5 Configure	text string	7 (Fault Reset)		95
726	MOL Polarity	text string	1 (NO Operate)		96
727	MOL Configure	text string	21 (MOL)		95
740	Thres 1 Select	text string	9 (Load High)		96
741	Thres 1 High	-300.00 to 300.00%	100.00%		96
742	Thres 1 Low	-300.00 to 300.00%	0.00%		96
743	Thres 2 Select	text string	15 (Current High)		97
744	Thres 2 High	-300.00 to 300.00%	100.00%		97
745	Thres 2 Low	-300.00 to 300.00%	0.00%		97
746	Timer 1 Type	text string	0 (On Delay)		97
747	Timer 1 Signal	text string	1 (Drv Fault)		97
748	Timer 1 Time	0.0 - 320.0 sec	1.0 sec		97
749	Timer 2 Type	text string	0 (On Delay)		97
750	Timer 2 Signal	text string	1 (Drv Fault)		98
751	Timer 2 Time	0.0 - 320.0 sec	1.0 sec		98
794	Drive Name	text string	serial number		98
799	Config USB Mode	text string	0 (Disabled)		98
801	Program Number	0-9999	0		99
802	Start Options	text string	0 (LS Lockout)		99
803	PWM Frequency	0.6-16.0 kHz	3.0 kHz		100
804	Display Mode	text string	0 = Std Disply		100
805	Display Units	alphanumeric	0 (blank)		100
809	Display Scale	1-65535	18000		100
810	Language	text string	0 (English)		100
811	Access Code	0-9999	0		101
812	Freq Ref Output	text string	0 (6FS)		101
813	Speed Ratio	0.0-200.0%	100.0%		101
814	Display Status	text string	0 (Drive load)		101
816	Fly Catch Mode	text string	0 (Sweep FWD)		101
819	Flt Text #1	text string	User Flt 1		101
825	Flt Text #2	text string	User Flt 2		102
850	PID Configure	text string	0 (No PID)		102
851	PID FBk Config	text string	0 (Vin1)		102
852	PID Prop Gain	0-2000	0		102
853	PID Int Gain	0-10000	0		102
854	PID Feed Gain	0-2000	1000		102
855	PID Error 1	0.00-100.00%	Read-only		102
856	PID Error 2	0.00-100.00%	Read-only		102
857	PID High Corr	0.00-100.00%	100.00%		103
858	PID Low Corr	0.00-100.00%	0.00%		103
859	PID Deriv Gain	0-200	0.00%		103

Note that all parameters can be addressed by adding 40000 to the parameter number. For example, parameter 201 (Input Mode) can be addressed by Modbus address 40201.

█ = cannot change in Run
Bold type = Level 1 parameter

No.	Parameter Name	Options	Default	User Setting	See Page
860	PID Sleep Cfg	text string	0 (disabled)		103
861	PID Sleep Lvl	0.00-100.00%	0.00%		103
862	PID Wake-up Lvl	0.00-100.00%	100.00%		103
863	Sleep Delay Time	0.0-300.0 sec	0.0 sec		103
864	Wake-up Delay	0.0-300.0 sec	0.0 sec		103
865	PID Feedback	0.00-100.00%	Read-only		103
866	PID Reference	0.00-100.00%	Read-only		103
867	PID User Units	text string	0 (No)		103
880	FBus Read 1	0-65535	103		104
881	FBus Read 2	0-65535	104		104
882	FBus Read 3	0-65535	105		104
883	FBus Read 4	0-65535	107		104
884	FBus Read 5	0-65535	909		104
890	FBus Write 1	0-65535	907		104
891	FBus Write 2	0-65535	402		104
892	FBus Write 3	0-65535	403		104
893	FBus Write 4	0-65535	920		104
894	FBus Write 5	0-65535	921		104
900	SIO Protocol	text string	0 (RTU N81)		104
901	SIO Baud Rate	text string	2 (9600)		104
902	Comm Drop #	1-247	1		104
903	SIO Timer	0.0-60.0 sec	1.0 sec		104
904	SIO Cntl Word	Bit 0-15	0x0000		105
905	Ext Ref Freq1	Min-Max Freq	0.0 Hz		105
906	Ext Ref Freq2	Min-Max Freq	0.0 Hz		105
907	Cntl Word 2	Bit 0-15	0x0000		105
908	Status Word	Bit 0-15	Read-only		105
909	DI Status	Bit 0-14	Read-only		106
910	Vin1 Status	0.00-100.00%	Read-only		106
911	Cin Status	0.00-100.00%	Read-only		106
912	Vin2 Status	0.00-100.00%	Read-only		106
913	Output Status	Bit 0-5	Read-only		106
914	Vmet Status	0.00-100.00%	Read-only		106
915	Imet Status	0.00-100.00%	Read-only		106
916	Infrared Baud	text string	2 (9600)		106
917	FBus Port Config	text string	1 (485 w/ctl)		107
920	SIO Vmet Level	0.00-100.00%	100.00%		107
921	SIO Imet Level	0.00-100.00%	100.00%		107
926	Status Word 2	Bit 0-2	Read-only		107
930	Seq Cntl 1	Bit 0-15 (hex control)	0x0000		108
931	Seq Cntl 2	Bit 0-15 (hex control)	0x0000		108
932	Seq Cntl 3	Bit 0-15 (hex control)	0x0000		108
933	Seq Cntl 4	Bit 0-15 (hex control)	0x0000		108
934	Seq Cntl 5	Bit 0-15 (hex control)	0x0000		108
935	Seq Cntl 6	Bit 0-15 (hex control)	0x0000		108
936	Seq Cntl 7	Bit 0-15 (hex control)	0x0000		108
937	Seq Cntl 8	Bit 0-15 (hex control)	0x0000		108
938	Seq Cntl 9	Bit 0-15 (hex control)	0x0000		108
939	Seq Cntl 10	Bit 0-15 (hex control)	0x0000		108
940	Seq Cntl 11	Bit 0-15 (hex control)	0x0000		108
941	Seq Cntl 12	Bit 0-15 (hex control)	0x0000		108
942	Seq Cntl 13	Bit 0-15 (hex control)	0x0000		108

Note that all parameters can be addressed by adding 40000 to the parameter number. For example, parameter 201 (Input Mode) can be addressed by Modbus address 40201.

█ = cannot change in Run
Bold type = Level 1 parameter

No.	Parameter Name	Options	Default	User Setting	See Page
943	Seq Cntl 14	Bit 0-15 (hex control)	0x0000		108
944	Seq Cntl 15	Bit 0-15 (hex control)	0x0000		108
945	Seq Cntl 16	Bit 0-15 (hex control)	0x0000		108
946	Seq Cntl 17	Bit 0-15 (hex control)	0x0000		108
947	Seq Cntl 18	Bit 0-15 (hex control)	0x0000		108
948	Seq Cntl 19	Bit 0-15 (hex control)	0x0000		108
949	Seq Cntl 20	Bit 0-15 (hex control)	0x0000		108
950	Seq Cntl 21	Bit 0-15 (hex control)	0x0000		108
951	Seq Cntl 22	Bit 0-15 (hex control)	0x0000		108
952	Seq Cntl 23	Bit 0-15 (hex control)	0x0000		108
953	Seq Cntl 24	Bit 0-15 (hex control)	0x0000		108
954	Seq Cntl 25	Bit 0-15 (hex control)	0x0000		108
955	Seq Count 1	0-65535	0		109
956	Seq Count 2	0-65535	0		109
957	Seq Count 3	0-65535	0		109
958	Seq Count 4	0-65535	0		109
959	Seq Count 5	0-65535	0		109
960	Seq Count 6	0-65535	0		109
961	Seq Count 7	0-65535	0		109
962	Seq Count 8	0-65535	0		109
963	Seq Count 9	0-65535	0		109
964	Seq Count 10	0-65535	0		109
965	Seq Count 11	0-65535	0		109
966	Seq Count 12	0-65535	0		109
967	Seq Count 13	0-65535	0		109
968	Seq Count 14	0-65535	0		109
969	Seq Count 15	0-65535	0		109
970	Seq Count 16	0-65535	0		109
971	Seq Count 17	0-65535	0		109
972	Seq Count 18	0-65535	0		109
973	Seq Count 19	0-65535	0		109
974	Seq Count 20	0-65535	0		109
975	Seq Count 21	0-65535	0		109
976	Seq Count 22	0-65535	0		109
977	Seq Count 23	0-65535	0		109
978	Seq Count 24	0-65535	0		109
979	Seq Count 25	0-65535	0		109
980	Seq Decision 1	Bit 0-15	0x0000		109
981	Seq Decision 2	Bit 0-15	0x0000		109
982	Seq Decision 3	Bit 0-15	0x0000		109
983	Seq Decision 4	Bit 0-15	0x0000		109
984	Seq Decision 5	Bit 0-15	0x0000		109
1500	Last Fault	All fault options	Read-only		109
1527	9th Fault	All fault options	Read-only		109
1554	8th Fault	All fault options	Read-only		109
1581	7th Fault	All fault options	Read-only		109
1608	6th Fault	All fault options	Read-only		110
1635	5th Fault	All fault options	Read-only		110
1662	4th Fault	All fault options	Read-only		110
1689	3rd Fault	All fault options	Read-only		110
1716	2nd Fault	All fault options	Read-only		110
1743	1st Fault	All fault options	Read-only		110

Note that all parameters can be addressed by adding 40000 to the parameter number. For example, parameter 201 (Input Mode) can be addressed by Modbus address 40201.

CONTENTS

Summary of X5 Parameters	iii
Chapter 1: Introduction	12
1.1 Product Overview	12
1.2 Overview of This Manual	12
1.3 User's Manual Publication History	13
Chapter 2: Technical Characteristics	14
2.1 Interpreting Model Numbers	14
2.2 Power and Current Ratings	16
2.3 Environmental Specifications	18
2.4 Electrical Specifications	18
2.5 Control Features Specifications	19
2.6 Dimensions and Weights	20
Chapter 3: Receiving and Installation	24
3.1 Preliminary Inspection	24
3.2 Installation Precautions	24
3.3 Dissipation Requirements	25
3.4 Cover Assembly and Torque Specifications	26
3.5 Serial Number Label	27
3.6 Conduit Usage	27
3.7 Condensation	27
Chapter 4: Connections	28
4.1 Introduction	29
4.2 General Wiring Information	29
4.2.1 Wiring Practices	29
4.2.2 Considerations for Power Wiring	29
4.2.3 Considerations for Control Wiring	30
4.3 Input Line Requirements	31
4.3.1 Line Voltage	31
4.3.2 Line Capacity	31
4.3.3 Phase Imbalance	31
4.3.4 Single-phase Operation	32
4.3.5 Ground Fault Circuit Interrupters (GFCI)	32
4.3.6 Motor Lead Length	32
4.3.7 Using Output Contactors	32
4.4 Terminals Found on the X5 Power Board	33
4.4.1 Description of the Terminals	33
4.4.2 Typical Power Connections	34
4.5 Dynamic Braking	36

4.6	Terminals Found on the X5 Control Board	38
4.6.1	Description of the Control Terminals	38
4.6.2	Typical Connection Diagrams for Digital Inputs	41
4.6.3	Typical Connection Diagrams for Analog Inputs	42
4.6.4	Typical Connection Diagrams for Analog Outputs	42
4.6.5	Modbus Connection Diagram	43
4.7	Reducing Current Surges and Voltage Transients	43
Chapter 5: Operation and Programming		44
5.1	Introduction	44
5.2	Keypad Operation	45
5.3	LCD Displays	47
5.3.1	Control	47
5.3.2	X5 Keypad Status and Warning Messages	47
5.3.3	Rights	49
5.3.4	Other Data	49
5.4	Keypad Display Window	49
5.5	Programming	50
5.5.1	Accessing Parameters	50
5.5.2	Changing the Display Scroll Rate	50
5.5.3	Programming Procedure	50
5.5.4	Restoring Factory Settings	51
5.5.5	Viewing Parameters That Have Changed	51
5.5.6	Using Macro Mode	51
5.6	Measuring Stator Resistance (RS Measurement)	51
5.6.1	Activating Automatic RS Measurement via Keypad	51
5.6.2	Activating Automatic RS Measurement via Serial Link (Modbus)	52
5.7	Storing Data and Reflashing Using a Flash Memory Device	52
5.7.1	Storing Drive Parameters	52
5.7.2	Recalling Drive Parameters	53
5.7.3	Storing Keeper Files	53
5.7.4	Reflashing the X5 Using the USB Port and a Flash Memory Device	53
5.8	Using the Keeper Data Log	55
5.8.1	Keeper Parameters	55
5.8.2	Setting up the Keeper Function	56
5.9	Using the X5 Real-Time Clock and Other Special Features	57
5.9.1	Enabling the X5 Based on Time of Day (TOD)	57
5.9.2	Reminders	58
5.9.3	Timers	58
5.9.4	Thresholds	58
Chapter 6: Using Macro Mode and Getting a Quick Start		60
6.1	Entering Macro Mode	60
6.2	Description of Parameters Used in Macro Mode	61
6.3	Macro Mode Applications and Included Parameters	63
6.4	Getting a Quick Start	69

Chapter 7: X5 Parameters	70
7.1 Introduction	70
7.2 Level 1 Parameters	70
7.3 Description of Parameters	71
7.4 Using the X5 Program Sequencer	110
7.4.1 Enabling the X5 Program Sequencer	110
7.4.2 Controlling the X5 Program Sequencer	111
7.4.3 Sequencer State Configuration Overview	113
7.4.4 Advancement on Drive State Conditions	118
7.4.5 Sequencer Decision Configuration	119
7.4.6 Sequencer Status Indicators	120
7.4.7 Sample Sequencer Program	121
Blank Worksheet to Remove and Copy	123
Chapter 8: Troubleshooting and Fault Codes	125
Chapter 9: X5 Options	131
Appendix A: Parameter 201 Options	132
Appendix B: Binary-Hexadecimal Conversion	133
EU Declaration of Conformity	135

Chapter 1: Introduction

1.1 Product Overview

The X5 AC drive provides an economical, powerful solution for a large array of industrial applications. It features remote communications capability (using Ethernet, Devicenet, Modbus[®] and Modbus[®] TCP/IP protocols), a keypad for easy configuration, and standard NEMA 4X / IP66 and NEMA 12 / IP55 enclosures that eliminate the need for mounting in a separate enclosure. A USB interface allows you to copy parameters from drive to drive, and to download data logs. Like the X4 AC drive, it provides a robust, compact solution for industrial applications, but with more capability.

The X5 product family includes a wide variety of models to suit almost any input voltage requirement. An ‘x’ in the following table indicates what models are currently available. Refer to [“Chapter 2: Technical Characteristics” on page 14](#) for help in interpreting model numbers.

Horsepower	Input Voltage			
	115 Vac 1 Phase	230 Vac 3 Phase	460 Vac 3 Phase	575 Vac 3 Phase
1	x	x	x	x
2		x	x	x
3		x	x	x
5		x	x	x
7.5		x	x	x
10		x	x	x
15		x	x	x
20		x	x	x
25		x	x	x
30		x	x	x
40			x	x
50			x	x
60			x	x
75			x	x
100			x	x
125			x	x
150			x	x
200			x	x

1.2 Overview of This Manual

This manual contains specifications, receiving and installation instructions, configuration, description of operation, options, and troubleshooting procedures for X5 AC drive devices.

For experienced users, a [Quick-Start](#) section begins on page 69. A [summary of parameters](#) begins on page iii of this manual.

1.3 User's Manual Publication History

Date	Form Number	Nature of Change
July 2007	1434	First release
April 2008	1434A	Added information regarding new models, new parameters, and model options. Made corrections throughout manual. Added Appendix for Parameter 201.
June 2008	1434B	Corrected Figure 7-3 in Sequencer section. Updated Vacon corporate information.
October 2008	DPD00089	Changed installation diagrams to reflect changes in product; changed photographs of product; added information to Chapter 2 on current surges and voltage transients; added parameters 614-15, 719, and changed ranges for parameters 862-864. Made changes to Sect. 7.4.3, Sequencer State Configuration Overview.
April 2009	DPD00089A	Revised EU Declaration of Conformity

Chapter 2: Technical Characteristics

2.1 Interpreting Model Numbers

The model number of the X5 AC drive appears on the shipping carton label and on the technical data label on the model. The information provided by the model number is shown below:

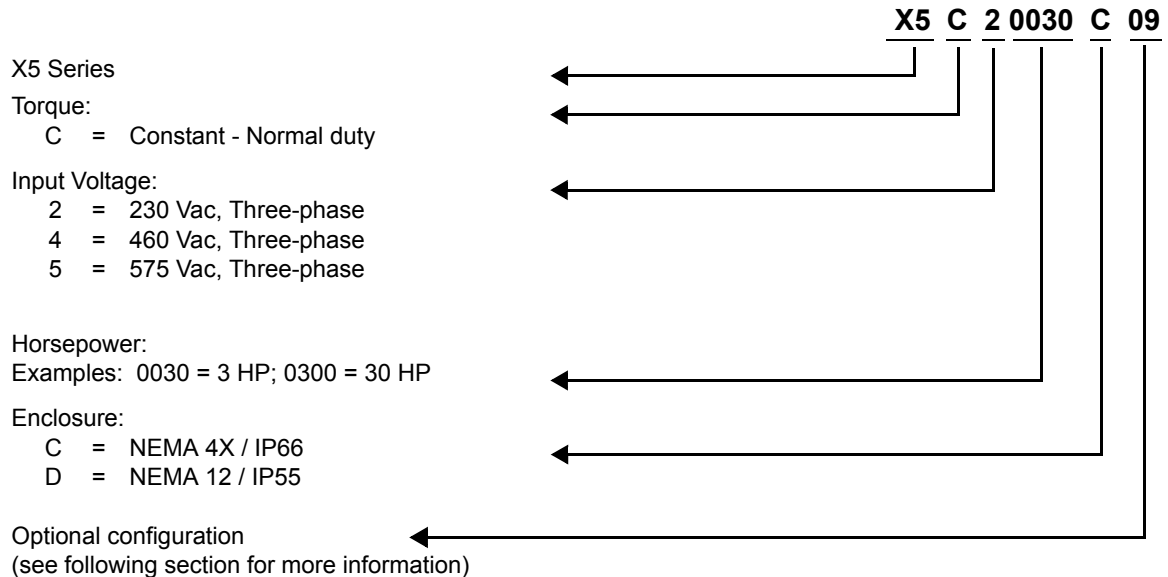

X5 Models without option card capability

Smaller horsepower models (30 HP or less) of X5 drives with optional configuration -09 have the same electrical capabilities as the other X5 models, but do not support option cards. These smaller-frame models are offered in smaller enclosures (frame size 0, 1, and 2). Table 2-1 shows the model and size relationships of all the X5 drives.

Table 2-1: Model Number / Frame Size Cross-Reference

Part #	Frame Size	Part #	Frame Size	Part #	Frame Size
X5C1S010C	1				
X5C1S010C09	0				
X5C20010C	1	X5C40010C	1	X5C50010C	1
X5C20010C09	0	X5C40010C09	0	X5C50010C09	1A
X5C20020C	1	X5C40020C	1	X5C50020C	1
X5C20020C09	0	X5C40020C09	0	X5C50020C09	1A
X5C20030C	1	X5C40030C	1	X5C50030C	1
X5C20030C09	0	X5C40030C09	0	X5C50030C09	1A
X5C20050C	1	X5C40050C	1	X5C50050C	1
X5C20050C09	1A	X5C40050C09	1A	X5C50050C09	1A
X5C20075C	1	X5C40075C	1	X5C50075C	1
X5C20075C09	1A	X5C40075C09	1A	X5C50075C09	1A
X5C20100C	2	X5C40100C	1	X5C50100C	1
X5C20100C09	2A	X5C40100C09	1A	X5C50100C09	1A
X5C20150C	2	X5C40150C	2	X5C50150C	2
X5C20150C09	2A	X5C40150C09	2A	X5C50150C09	2A
X5C20200C	3	X5C40200C	2	X5C50200C	2
X5C20250C	3	X5C40200C09	2A	X5C50200C09	2A
X5C20300C	3	X5C40250C	2	X5C50250C	2
		X5C40250C09	2A	X5C50250C09	2A
		X5C40300C	2	X5C50300C	2
		X5C40300C09	2A	X5C50300C09	2A
		X5C40400C	3	X5C50400C	3
		X5C40500C	3	X5C50500C	3
		X5C40600C	4	X5C50600C	4
		X5C40750C	4	X5C50750C	4
		X5C41000C	4	X5C51000C	4
		X5C41250D	5	X5C51250D	5
		X5C41500D	5	X5C51500D	5
		X5C42000D	5	X5C52000D	5

2.2 Power and Current Ratings

115 Vac Ratings												
Model number	Normal Duty		Input current (A)		Output current (A)		Heavy Duty		Input current (A)		Output current (A)	
	HP	kW	--	115 Vac	--	230 Vac	HP	kW	--	230 Vac	--	230 Vac
X5C1S010C	1	0.75	--	15	--	4.2	0.5	0.37	--	11	--	2.2

230 Vac Ratings												
Model number	Normal Duty		Input current (A)		Output current (A)		Heavy Duty		Input current (A)		Output current (A)	
	HP	kW	200 Vac	230 Vac	200 Vac	230 Vac	HP	kW	200 Vac	230 Vac	200 Vac	230 Vac
X5C20010C	1	0.75	5.6	4.8	4.8	4.2	0.5	0.37	2.9	2.5	2.5	2.2
X5C20020C	2	1.5	9	7.8	7.8	6.8	1	0.75	5.6	4.8	4.8	4.2
X5C20030C	3	2.2	12.7	11	11	9.6	2	1.5	9	7.8	7.8	6.8
X5C20050C	5	4	20.2	17.5	17.5	15.2	3	2.2	12.7	11	11	9.6
X5C20075C	7.5	5.5	29.2	25.3	25.3	22	5	4	20.2	17.5	17.5	15.2
X5C20100C	10	7.5	37.2	32.2	37.2	28	7.5	5.5	29.2	25.3	25.3	22
X5C20150C	15	11	52.1	46.4	48.3	42	10	7.5	37.2	32.2	37.2	28
X5C20200C	20	15	68.3	57.4	62.1	54	15	11	52.1	46.4	48.3	42
X5C20250C	25	18.5	82.3	73.8	78.2	68	20	15	68.3	57.4	62.1	54
X5C20300C	30	22	96	84	92	80	25	18.5	82.3	73.8	78.2	68

NOTE: All 230 Vac models can be operated at single-phase, with 50% derating

460 Vac Ratings												
Model number	Normal Duty		Input current (A)		Output current (A)		Heavy Duty		Input current (A)		Output current (A)	
	HP	kW	380 Vac	460 Vac	380 Vac	460 Vac	HP	kW	380 Vac	460 Vac	380 Vac	460 Vac
X5C40010C	1	0.75	3.0	2.4	2.4	2.1	0.5	0.37	1.6	1.3	1.3	1.1
X5C40020C	2	1.5	5.2	3.9	3.8	3.4	1	0.75	3.0	2.4	2.4	2.1
X5C40030C	3	2.2	7.2	5.6	5.1	4.8	2	1.5	5.2	3.9	3.8	3.4
X5C40050C	5	4	12	8.8	8.9	7.6	3	2.2	7.2	5.6	5.1	4.8
X5C40075C	7.5	5.5	15	12.8	12	11	5	4	12	8.8	8.9	7.6
X5C40100C	10	7.5	19.7	16.3	15.6	14	7.5	5.5	15	12.8	12	11
X5C40150C	15	11	30.9	25.8	23	21	10	7.5	19.7	16.3	15.6	14
X5C40200C	20	15	40	33.3	31	27	15	11	30.9	25.8	23	21
X5C40250C	25	18	46.3	40	37	34	20	15	40	33.3	31	27
X5C40300C	30	22	57.5	47.8	43	40	25	18	46.3	40	37	34
X5C40400C	40	30	73.2	62.4	61	52	30	22	57.5	47.8	43	40
X5C40500C	50	37	82	78	71	65	40	30	73.2	62.4	61	52
X5C40600C	60	45	94	80	86	77	50	37	82	78	71	65
X5C40750C	75	55	114	99	105	96	60	45	94	80	86	77
X5C41000C	100	75	149	129	140	124	75	55	114	99	105	96
X5C41250D	125	90	168	156	168	156	100	75	140	124	140	124
X5C41500D	150	110	205	180	205	180	125	90	168	156	168	156
X5C42000D	200	132	240	240	240	240	150	110	205	180	205	180

575 Vac Ratings

Model number	Normal Duty		Input current (A)		Output current (A)		Heavy Duty		Input current (A)		Output current (A)	
	HP	kW	-	575 Vac	-	575 Vac	HP	kW	-	575 Vac	-	575 Vac
X5C50010C	1	0.75	-	2.0	-	1.7	0.5	0.37	-	1.2	-	0.9
X5C50020C	2	1.5	-	3.6	-	2.7	1	0.75	-	2.0	-	1.7
X5C50030C	3	2.2	-	5.0	-	3.9	2	1.5	-	3.6	-	2.7
X5C50050C	5	4	-	7.6	-	6.1	3	2.2	-	5.0	-	3.9
X5C50075C	7.5	5.5	-	10.4	-	9.0	5	4	-	7.6	-	6.1
X5C50100C	10	7.5	-	14.1	-	11.0	7.5	5.5	-	10.4	-	9.0
X5C50150C	15	11	-	23	-	17	10	7.5	-	14.1	-	11
X5C50200C	20	15	-	31	-	22	15	11	-	23	-	17
X5C50250C	25	18	-	37	-	27	20	15	-	31	-	22
X5C50300C	30	22	-	39.5	-	32	25	18	-	37	-	27
X5C50400C	40	30	-	49	-	41	30	22	-	39.5	-	32
X5C50500C	50	37	-	58	-	52	40	30	-	49	-	41
X5C50600C	60	45	-	68	-	62	50	37	-	58	-	52
X5C50750C	75	55	-	82	-	77	60	45	-	68	-	62
X5C51000C	100	75	-	107	-	99	75	55	-	82	-	77
X5C51250D	125	90	-	125	-	125	100	75	-	99	-	99
X5C51500D	150	110	-	144	-	144	125	90	-	125	-	125
X5C52000D	200	132	-	192	-	192	150	110	-	144	-	144

2.3 Environmental Specifications

Operating temperature	-10 °C to +40 °C (14 °F to 104 °F)
Storage temperature	-20 °C to +65 °C (-4 °F to 149 °F)
Humidity	0% to 95% non-condensing
Altitude	1000 m (3300 ft) without derating
Maximum vibration	per EN50178 (1g @ 57-150 Hz)
Acoustic noise	80 dba sound power at 1 m (3 ft), maximum
Cooling	1-5 HP models: Natural convection 7.5 to 200.0 HP models: Forced air (temperature-controlled external fan) The 575 Vac, 5 HP model has a fan.

2.4 Electrical Specifications

Input voltage	X5C1x models: 115 Vac, 1 phase, +/- 10% 1 HP X5C2x models: 200-230 Vac, 3 phase, +/- 15% 1-30 HP X5C4x models: 380-460 Vac, 3 phase, +/- 15% 1-200 HP X5C5x models: 575Vac, 3 phase, +/-15% 1-200 HP
Line frequency	50 / 60 Hz ±2 Hz
Source kVA (maximum)	10 times the unit rated kVA, 65kA maximum (see note below)
DC bus voltage for:	115/230 Vac models 460 Vac models 575 Vac models
Overvoltage trip	406 Vdc 814 Vdc 1017 Vdc
Dynamic brake activation	388 Vdc 776 Vdc 970 Vdc
Nominal undervoltage (UV) trip	199 Vdc 397 Vdc 497 Vdc
Control system	V/Hz or Sensorless Vector Control (SVC) Carrier frequency = 1 - 16 kHz, programmable; 8 kHz max. for 125-200 HP models
Output voltage	3-phase: 0 to 100% of incoming voltage (0-230 Vac for 115 Vac models)
Overload capacity	120% of rated RMS current for 60 seconds (normal duty rating) 150% of rated RMS current for 60 seconds (heavy duty rating)
Frequency range	0.1 to 400 Hz
Frequency stability	0.1 Hz (digital), 0.1% (analog) over 24 hours +/- 10 °C
Frequency setting	By keypad, or by external signal (0 to 5 Vdc; 0 to 10 Vdc; 0/4 to 20 mA) or by pulse train up to 100kHz

Note: Unit Rated kVA = rated Voltage x rated Current x 1.732

2.5 Control Features Specifications

Vin1 reference input	0-5/10 Vdc, 0/4-20 mAdc (250 Ω load) 6FS pulse train input from another drive, 0-1/10/100 kHz pulse input, inverted function, 0-5-10 bipolar input, broken wire detection. Span and offset adjustment.
Vin2 reference input	0-5/10 Vdc, 0-5-10 bipolar input, inverted function, broken wire detection, span and offset adjustment. Programmable for frequency reference, current limit input, or feedback signal.
Cin reference input	0/4-20 mAdc (50 Ω load), inverted function, span and offset adjustment. Programmable for frequency reference, current limit input, or feedback signal.
Reference voltage	10 Vdc (10 mAdc maximum)
Digital inputs - 10	Off=0 to 3 Vdc; On=10 to 32 Vdc (pull-up logic), selectable between pull-up and pull-down logic
Digital supply voltage	24 Vdc (150 mAdc maximum)
Preset frequencies	4 inputs for 15 preset frequencies (selectable)
Digital outputs	2 SPDT relay outputs - 130 Vac, 1 A/250 Vac, 0.5 A 2 open collector outputs 50 mA per device; 2 optional relays; optional encoder interface
Digital pulse train output	Open collector output pulse train proportional to output frequency
Vmet analog output	0 to 10 Vdc (5 mAdc maximum)
Imet analog output	0/4-20 mAdc output into a 500 Ω load (maximum)
DC holding / injection braking	At start, stop, by frequency with adjustable current level and time or continuous DC injection by digital input.
Current limit	Four quadrant adjustable from 5 to 150%
Speed ramps	Primary and alternate adjustable from 0.1 to 3200.0 seconds
Voltage boost	Adjustable fixed boost or adjustable auto boost
Voltage characteristic	V/Hz: Linear, pump, fan, or 2-piece linear. Also sensorless vector (SVC).
Timed overload	Adjustable inverse time trip (shear pin, 30 seconds, 60 seconds, 5 minutes), for standard or inverter-duty motors
Protective features	Overcurrent, overvoltage fault, ground fault, short circuit, dynamic brake overload, drive temperature, power wiring fault, drive timed overload, input voltage quality, overvoltage ridethrough
Program Sequence Logic Controller (PSLC)	25-step (with ability to branch), PLC-type functionality that can control speed, direction, and ramps based on time, analog input, digital input, or pulse input. Addressable outputs and real-time operations possible. See "Using the X5 Program Sequencer" on page 111.
PID Feedback	Process control available with the use of a customer-supplied transducer, either 0-10 Vdc, 4-20 mA, or optical encoder input to the drive. Includes an optional sleep mode, activated when the loop is satisfied.
Serial communications	Modbus, DeviceNet option, Ethernet IP option, Modbus TCP/IP option

2.6 Dimensions and Weights

Table 2-2 lists dimensions and weights for the X5 frame size 0, 1, 2, and 3 models. Dimensions and weights for the X5 frame size 4 and 5 models are shown in Table 2-3 on page 22. You may wish to refer to the cross-reference table on page 15 for X5 model numbers / frame sizes.

See Figures 2-2, 2-2, 2-3, 2-4, 2-5, and 2-6 on pages 21 - 23 for locations of dimensions. Dimensions A onward are in inches / millimeters (in/mm). Weight is in pounds / kilograms (lb/kg).

Table 2-2: Dimensions and Weights for Frame Sizes 0 - 2

Frame		0	1 / 1A	2 / 2A
Dimensions in (mm) (See X5 diagrams on pages 21 through 23)	A	9.47 (241)	12.01 (305)	17.38 (441)
	B	6.50 (165)	8.72 (221)	10.75 (273)
	C	6.08 (155)	8.49 (216) / 6.51 (166)	9.89 (251) / 7.91 (201)
	D	8.45 (215)	11.03 (280)	16.50 (419)
	E	5.69 (145)	7.88 (200)	9.76 (248)
	F	0.28 (7.11)	0.28 (7)	0.41 (10)
	G	3.84 (98)	4.05 (103)	4.72 (120)
	H	2.77 (70)	N/A	N/A
	J	1.93 (49)	2.31 (59)	2.88 (73)
	K	2.85 (72)	3.94 (100)	4.84 (123)
	L	3.75 (95)	5.56 (1.41)	6.88 (175)
	M	0.88 (22)	0.88 (22)	1.38 (35)
	N	N/A	N/A	1.13 (29)
P	N/A	N/A	N/A	
Q	N/A	N/A	N/A	
Weight lb (kg)		8.5 (3.85)	14.0 (6.35)	29.5 (13.38)

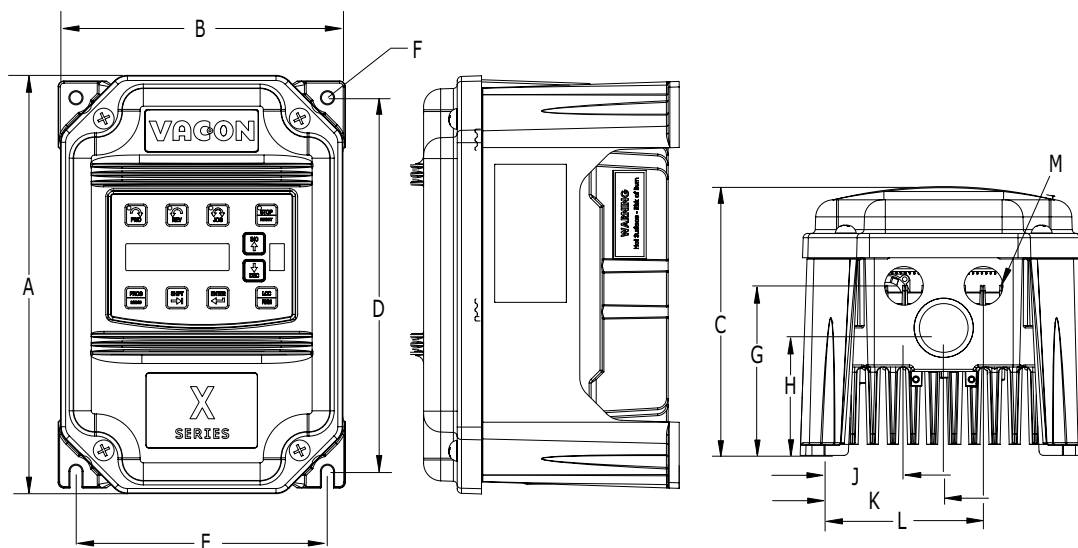

Figure 2-1: X5 Frame Size 0 Models

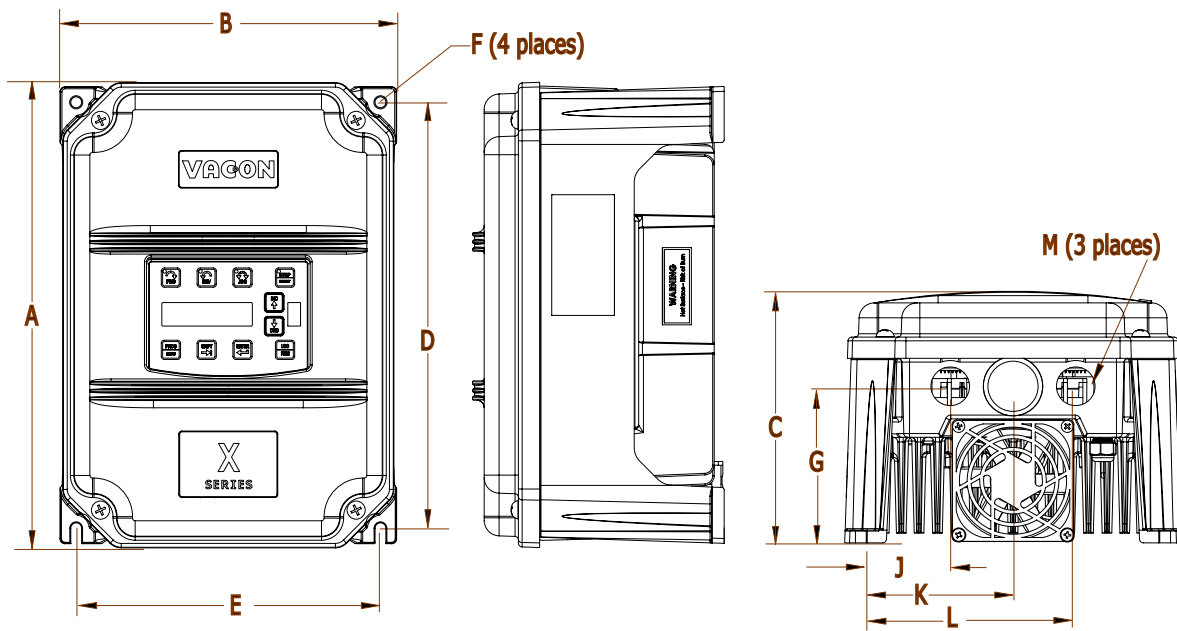

Figure 2-2: X5 Frame Size 1 Models

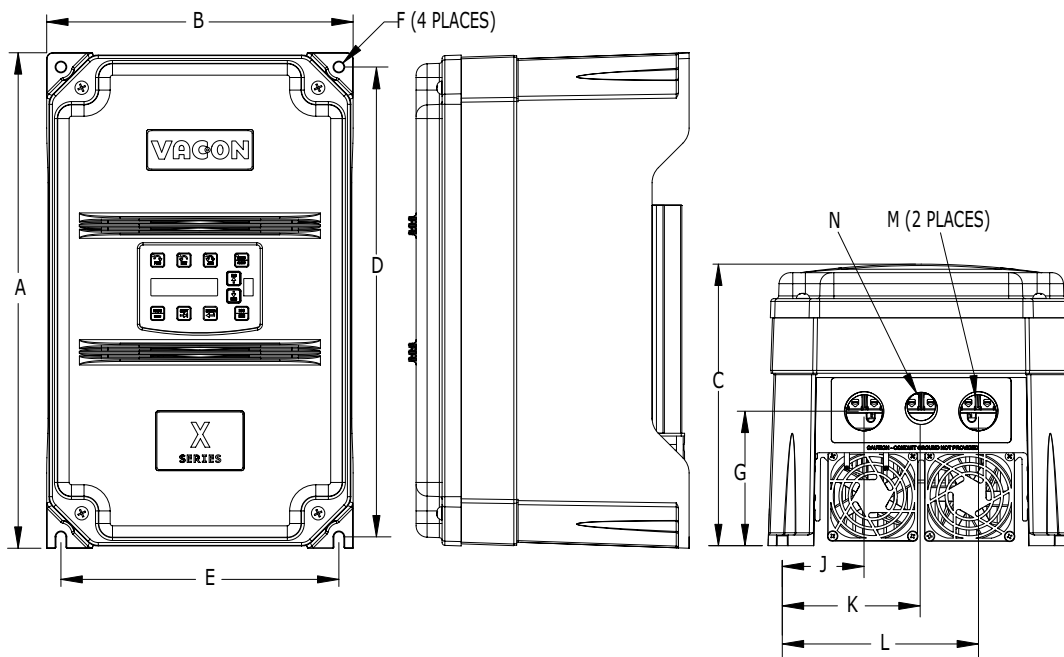

Figure 2-3: X5 Frame Size 2 Models

Table 2-3: Dimensions and Weights for Frame Sizes 3 - 5

Frame		3	4	5
Dimensions in (mm) (See X5 diagrams on pages 23 - 23)	A ¹	20.19 (513)	29.35 (745)	50.77 (1290)
	B	11.25 (286)	12.84 (326)	16.31 (414)
	C	11.73 (314)	13.80 (351)	16.88 (429)
	D	19.25 (489)	28.00 (711)	45.77 (1163)
	E	7.88 (200)	7.88 (200)	7.65 (194)
	F	0.28 (7)	0.42 (11)	0.42 (11)
	G	7.78 (198)	8.63 (219)	12.57 (319)
	H	N/A	8.26 (210)	11.10 (282)
	J	0.65 (17)	0.53 (13)	0.20 (5)
	K	2.29 (58)	2.69 (68)	2.32 (59)
	L	3.95 (100)	3.94 (100)	3.82 (97)
	M	1.69 (43)	2.44 (62)	2.94 (75)
	N	0.88 (22)	0.88 (22)	0.88 (22)
	P	5.60 (142)	5.19 (132)	5.32 (135)
	Q	7.24 (184)	7.35 (187)	7.45 (189)
	R	N/A	10.23 (260)	N/A
S	N/A	1.94 (49)	1.86 (47)	
Weight lb (kg)		50.0 (22.68)	95.0 (43.10)	305.0 (138.35)

(1) For the X5C20300C, the A dimension changes to 21.00 inches (533 mm).

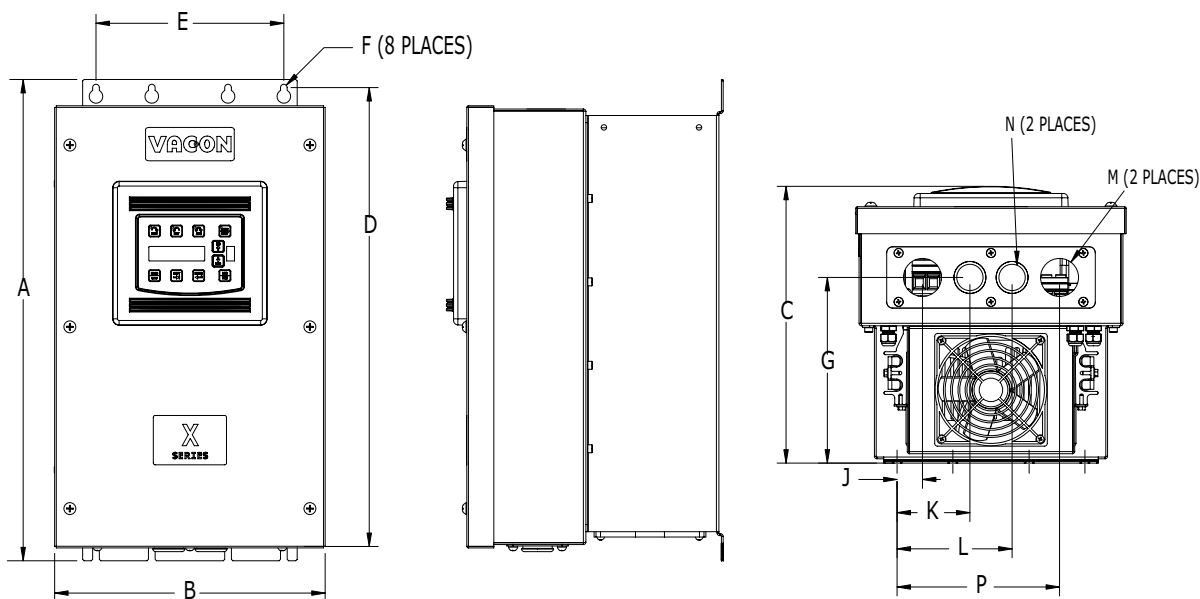

Figure 2-4: X5 Frame Size 3 Models

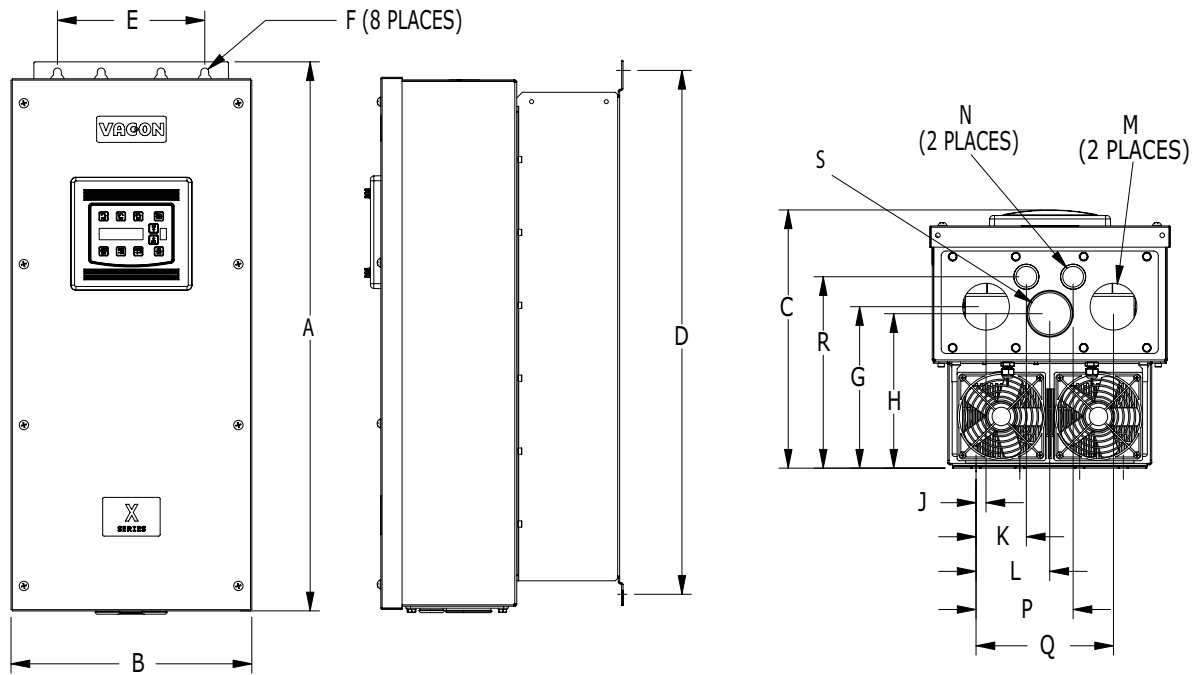

Figure 2-5: X5 Frame Size 4 Models

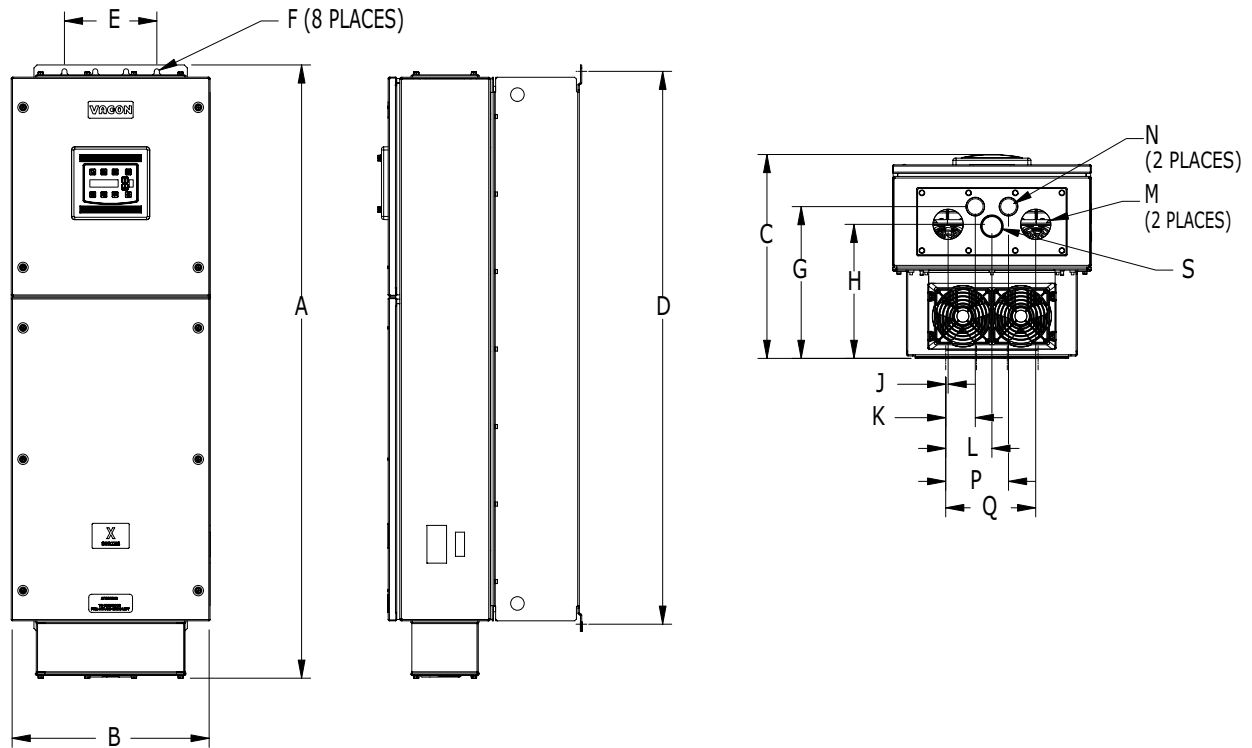

Figure 2-6: X5 Frame Size 5 Models

Chapter 3: Receiving and Installation

3.1 Preliminary Inspection

Before storing or installing the X5 drive, thoroughly inspect the device for possible shipping damage. Upon receipt:

1. Remove the drive from its package and inspect exterior for shipping damage. If damage is apparent, notify the shipping agent and your sales representative.
2. Remove the cover and inspect the drive for any apparent damage or foreign objects. (See [Figure 3-1 on page 26](#) for locations of cover screws.) Ensure that all mounting hardware and terminal connection hardware is properly seated, securely fastened, and undamaged.
3. Read the technical data label affixed to the drive and ensure that the correct horsepower and input voltage for the application has been purchased.
4. If you will be storing the drive after receipt, place it in its original packaging and store it in a clean, dry place free from direct sunlight or corrosive fumes, where the ambient temperature is not less than -20 °C (-4 °F) or greater than +65 °C (+149 °F).

⚠ CAUTION

EQUIPMENT DAMAGE HAZARD

Do not operate or install any drive that appears damaged.

Failure to follow this instruction can result in injury or equipment damage.

⚠ ATTENTION

RISQUE DE DOMMAGES MATÉRIELS

Ne faites pas fonctionner et n'installez pas tout variateur de vitesse qui semble être endommagé.

Si cette directive n'est pas respectée, cela peut entraîner des blessures corporelles ou des dommages matériels.

3.2 Installation Precautions

Improper installation of the X5 drive will greatly reduce its life. Be sure to observe the following precautions when selecting a mounting location. **Failure to observe these precautions may void the warranty!** See the inside front cover of this manual for more information about the warranty.

- Do not install the drive in a place subjected to high temperature, high humidity, excessive vibration, corrosive gases or liquids, or airborne dust or metallic particles. See [Chapter 2](#) for temperature, humidity, and maximum vibration limits.
- Do not mount the drive near heat-radiating elements or in direct sunlight.
- Mount the drive vertically and do not restrict the air flow to the heat sink fins.
- The drive generates heat. Allow sufficient space around the unit for heat dissipation. See [“Dissipation Requirements” on page 25](#).

3.3 Dissipation Requirements

Table 3-1: Dissipation Requirements for X5 Models in Enclosures (Page 1 of 2)

Model	Required Dissipation for Models Entirely Inside an Enclosure at Rated Current, 3KHz Carrier Frequency (Watts)
X5C1S010C	47
X5C20010C	48
X5C20020C	71
X5C20030C	92
X5C20050C	132
X5C20075C	177
X5C20100C	263
X5C20150C	362
X5C20200C	550
X5C20250C	653
X5C20300C	779
X5C40010C	34
X5C40020C	48
X5C40030C	71
X5C40050C	91
X5C40075C	114
X5C40100C	155
X5C40150C	304
X5C40200C	393
X5C40250C	459
X5C40300C	458
X5C40400C	695
X5C40500C	834
X5C40600C	776
X5C40750C	988
X5C41000C	1638
X5C41250D	1656
X5C41500D	1891

(continued on next page)

Table 3-1: Dissipation Requirements for X5 Models in Enclosures (Page 2 of 2)

Model	Required Dissipation for Models Entirely Inside an Enclosure at Rated Current, 3KHz Carrier Frequency (Watts)
X5C42000D	2302
X5C50010C	32
X5C50020C	50
X5C50030C	66
X5C50050C	112
X5C50075C	159
X5C50100C	187
X5C50150C	334
X5C50200C	431
X5C50250C	528
X5C50300C	597
X5C50400C	742
X5C50500C	877
X5C50600C	766
X5C50750C	913
X5C51000C	1542
X5C51250D	1988
X5C51500D	2282
X5C52000D	3043

3.4 Cover Assembly and Torque Specifications

Figure 3-1 shows the locations of the X5 cover screws. The torque range for the X Series Size 1 cover is 18-26 in/lbs.



Figure 3-1: X5 Cover Assembly and Screw Locations

Torque specifications for control terminals and power terminals are listed in [“General Wiring Information”](#) on page 29 .

3.5 Serial Number Label

Vacon, Inc. warrants all AC drives for three years from date of manufacture, or two years from the date of installation, whichever comes first. For a more detailed description of our warranty policy, see the inside front cover of this manual, or visit the web site at <http://www.vacon.com>. To determine if your drive is within the warranty time frame, find the bar code label or look in the lower left of the technical nameplate. The serial number can be broken down as follows:

yywwxxxx = **yy**...year of manufacture
ww...week of manufacture
xxxx...sequential number drive during that week

3.6 Conduit Usage

The X5 drive in the NEMA 4x / IP66 enclosure is rated for 1000 psi washdown from 6 inches. To keep this rating, the use of a sealed conduit is required. The use of a Romex-type conduit will not prevent water entry into the enclosure. If the approved conduit is not used, all warranty claims against water damage will be void.

3.7 Condensation

The washdown process of an X5 drive may create a temperature and humidity change in and around the drive. If the unit is mounted in a cool environment and washed down with higher-temperature water, as the drive cools to room temperature, condensation can form inside the drive, especially around the display. To prevent this from happening, avoid using sealed connectors around rubber-coated cables to seal the drive. These do not allow any air transfer and hence create a level of condensation and humidity that exceeds the drive's rating.

Chapter 4: Connections

DANGER

HAZARDOUS VOLTAGE

- Read and understand this manual in its entirety before installing or operating the X5 AC drive. Installation, adjustment, repair, and maintenance of these drives must be performed by qualified personnel.
- Disconnect all power before servicing the drive. **WAIT 5 MINUTES** until the DC bus capacitors discharge.
- **DO NOT** short across DC bus capacitors or touch unshielded components or terminal strip screw connections with voltage present.
- Install all covers before applying power or starting and stopping the drive.
- The user is responsible for conforming to all applicable code requirements with respect to grounding all equipment.
- Many parts in this drive, including printed circuit boards, operate at line voltage. **DO NOT TOUCH.** Use only electrically-insulated tools.

Before servicing the drive:

- Disconnect all power.
- Place a “DO NOT TURN ON” label on the drive disconnect.
- Lock the disconnect in the open position.

Failure to observe these precautions will cause shock or burn, resulting in severe personal injury or death.

DANGER

TENSION DANGEREUSE

- Lisez et comprenez ces directives dans leurs intégralité avant d'installer ou de faire fonctionner le variateur de vitesse X5. L'installation, le réglage, les réparations et l'entretien des ces variateurs de vitesse doivent être effectuées par du personnel qualifié.
- Coupez toutes les alimentations avant de travailler sur le variateur de vitesse. **ATTENDEZ CINQ MINUTES** pour que la décharge des condensateurs du bus cc s'effectue.
- NE court-cuitez PAS les condensateurs du bus cc ou ne touchez pas aux composantes non blindées ou aux connexions des vis du bornier si l'appareil est sous tension.
- Installez tous les couvercles avant de mettre le variateur de vitesse sous tension, de le mettre en marche ou de l'arrêter.
- L'utilisateur est responsable de la conformité avec tous les codes électriques en vigueur concernant la mise à la terre de tous les appareils.
- De nombreuses pièces de ce variateur de vitesse, y compris les cartes de circuits imprimés, fonctionnent à la tension du secteur. **N'Y TOUCHEZ PAS.** N'utilisez que des outils dotés d'une isolation électrique.

Avant tout entretien ou réparation sur le variateur de vitesse:

- Coupez toutes les alimentations.
- Placez une étiquette «NE PAS METTRE SOUS TENSION» sur le sectionneur du variateur de vitesse.
- Verrouillez le sectionneur en position ouverte.

Si ces précautions ne sont pas respectées, cela causera une électrocution ou des brûlures, ce qui entraînera des blessures graves ou la mort.

4.1 Introduction

This chapter provides information on connecting power and control wiring to the X5 AC drive.

4.2 General Wiring Information

4.2.1 Wiring Practices

When making power and control connections, observe these precautions:

- Never connect input AC power to the motor output terminals T1/U, T2/V, or T3/W. Damage to the drive will result.
- Power wiring to the motor must have the maximum possible separation from all other power wiring. Do not run in the same conduit; this separation reduces the possibility of coupling electrical noise between circuits.
- Cross conduits at right angles whenever power and control wiring cross.
- Good wiring practice also requires separation of control circuit wiring from all power wiring. Since power delivered from the drive contains high frequencies which may cause interference with other equipment, do not run control wires in the same conduit or raceway with power or motor wiring.

4.2.2 Considerations for Power Wiring

Power wiring refers to the line and load connections made to terminals L1/R, L2/S, L3/T, and T1/U, T2/V, T3/W respectively. Select power wiring as follows:

1. Use only UL-recognized wire.
2. Wire voltage rating must be a minimum of 300 V for 230 Vac systems and 600 V (Class 1 wire) for 460 or 575 Vac systems.
3. Wire gauge must be selected based on 125% of the continuous input current rating of the drive. Wire gauge must be selected from wire tables for 75 °C insulation rating, and must be of copper construction. The 230 V 7.5 and 15 HP models, and the 460 V 30 HP models require 90 °C wire to meet UL requirements. See [Chapter 2](#) for the continuous output ratings for the drive.
4. Grounding must be in accordance with NEC and CEC. If multiple X5 drives are installed near each other, each must be connected to ground. Take care not to form a ground loop.

See [Table 4-1](#) for a summary of wiring specifications.

Table 4-1: X5 Power Terminal Wiring Specifications

Frame Size	Specifications			
	Torque Nom.	Torque Max.	Max. Wire Size	Strip Length
Size 0	12 in-lbs	13 in-lbs	12-24 AWG	5/16" (0.3125")
Size 1	16 in-lbs	18 in-lbs	8-18 AWG	5/16" (0.3125")
Size 2	30 in-lbs		6-8 AWG	3/8" (0.38")
Size 3	35 in-lbs		3 AWG	
Size 4	65 in-lbs		3/0 AWG	
Size 5	132 in-lbs		400 MCM	

Note: Wire type not specified by the manufacturer. Some types of wire may not fit within the constraints of the conduit entry and bend radius inside the drive..

Table 4-2: User-Supplied Terminal Cross-Reference

Wire Size	Manufacturer	Manufacturer's P/N	Manufacturer	Manufacturer's P/N
3 AWG	T&B	54107		
2 AWG	T&B	54107		
1 AWG	T&B	54108		
1/0 AWG	T&B	54152-TB	Burndy	YA25-L6BOX
2/0 AWG	T&B	54157	Burndy	YA26-L5BOX
3/0 AWG	T&B	54162-TB	Burndy	YA27-LBOX
4/0 AWG			Burndy	YA28-LBOX
250 MCM			Burndy	YA29-LBOX
300 MCM			Burndy	YA30-L
350 MCM			Burndy	YA31-L
400 MCM			Burndy	YA32-L1

4.2.3 Considerations for Control Wiring

Control wiring refers to the wires connected to the control terminal strip. Select control wiring as follows:

1. Shielded wire is recommended to prevent electrical noise interference from causing improper operation or nuisance tripping.
2. Use only UL recognized wire.
3. Wire voltage rating must be at least 300 V for 230 Vac systems. It must be at least 600 V for 460 or 575 Vac systems.

See [Table 4-3](#) below for a summary of control wiring specifications.

Table 4-3: X5 Control Wiring Specifications

X5 Size / Models	Specifications
All Sizes / Models	4.4 in-lbs maximum torque 12-24 awg wire 9/32" strip length

4.3 Input Line Requirements

4.3.1 Line Voltage

See “Power and Current Ratings” on page 16 for the allowable fluctuation of AC line voltage for your particular X5 model. A supply voltage above or below the limits given in the table will cause the drive to trip with either an overvoltage or undervoltage fault.

Exercise caution when applying the X5 AC drive on low-line conditions.

For example, an X5 2000 series unit will operate properly on a 208 Vac line, but the maximum output voltage will be limited to 208 Vac. If a motor rated for 230 Vac line voltage is controlled by this drive, higher motor currents and increased heating will result.

Therefore, ensure that the voltage rating of the motor matches the applied line voltage.

4.3.2 Line Capacity

If the source of AC power to the X5 AC drive is greater than 10 times the kVA rating shown in Table 4-4 below, an isolation transformer or line reactor is recommended. Consult the factory for assistance in sizing the reactor.

Table 4-4: X5 Line Capacity (kVA)

Drive HP	5	7.5	10	15	20	25	30	40	50	60	75	100	125	150	200
Transformer kVA	9	13	18	23	28	36	42	57	70	90	112	150	180	220	250

Note: X5 AC drive devices are suitable for use on a circuit capable of delivering not more than 65,000 rms symmetrical amperes at 10% above the maximum rated voltage.

4.3.3 Phase Imbalance

Phase voltage imbalance of the input AC source can cause unbalanced currents and excessive heat in the drive's input rectifier diodes and DC bus capacitors. Phase imbalance can also damage motors running directly across the line. The phase imbalance should not exceed 2% of the voltage rating; if it does, the drive should be derated as a single-phase drive.

⚠ CAUTION

EQUIPMENT DAMAGE HAZARD

Never use power-factor correction capacitors on motor terminals T1/U, T2/V, or T3/W of the X5 AC drive. Doing so will damage the semiconductors.

Failure to follow this instruction can result in injury or equipment damage.

⚠ ATTENTION

RISQUE DE DOMMAGES MATÉRIELS

Ne raccordez jamais de condensateurs de correction du facteur de puissance aux bornes T1/U, T2/V, ou T3/W du moteur du variateur de vitesse X5. Car cela endommagera les semiconducteurs.

Si cette directive n'est pas respectée, cela peut entraîner des blessures corporelles ou des dommages matériels.

4.3.4 Single-phase Operation

X5 AC drive 230 Vac, 5-HP models are designed for both three-phase and single-phase input power. If one of these models is operated with single-phase power, use any two line input terminals. The output of the device will always be three-phase.

The safe derating of the X5 series of drives is 50% of the nominal current (HP) rating. Consult the factory with the particular application details for exact derating by model.

4.3.5 Ground Fault Circuit Interrupters (GFCI)

The GFCI breakers are designed for residential use to protect personnel from stray currents to ground. Most GFCI breakers will shut off at 5 mA of leakage. It is not uncommon for an AC drive to have 30 to 60 mA of leakage.

4.3.6 Motor Lead Length

It is recommended that the total lead length should not exceed the motor manufacturer's guidelines. Line disturbance and noise can be present in motor wiring of any distance. As a rule of thumb, any non-inverter duty motor should have a reactor or filter added when the motor lead length exceeds 150 feet. The carrier frequency for the drive should also be reduced using [parameter 803 \(PWM Frequency\)](#).

Nuisance trips can occur due to capacitive current flow to ground. These currents can cause shock to personnel and can create problems within the motor. Care should be taken when working in these areas.

Some applications can have a restricted lead length because of type of wire, motor type, or wiring placement. Consult the factory and the motor manufacturer for additional information.

4.3.7 Using Output Contactors

Contactors in the output wiring of an AC drive may be needed as part of the approved safety circuit. Problems can arise if these contactors are opened for the safety circuit and the drive is left in run mode of operation. When the contactor is open, the drive is in a no-load, no-resistance state, but is still trying to supply current to the motor. However, when the contactor closes, the drive sees the motor resistance and instantly demands current. This inrush of current when the contactor closes can fault or cause failure to the drive.

To prevent problems, interlock an auxiliary contact to the drive's Run or Enable circuit to stop the drive when the contactor opens. In this way, the drive will be disabled and no inrush will occur when the contactor is closed again.

4.4 Terminals Found on the X5 Power Board

4.4.1 Description of the Terminals

Table 4-5 describes the X5 power terminals.

Table 4-5: Description of X5 Power Terminals

Terminal	Description
L1/R L2/S L3/T	These terminals are the line connections for input power. (Single-phase 230 Vac, 5 HP models connect to any two of these terminals.)
T1/U T2/V T3/W	These terminals are for motor connections.

Note that earth ground is on the terminal strip (see [Figure 4-1](#)). Dynamic brake (DB) connections are not on the terminal strip, but on “fast on” (spade) connectors for models up to 30 HP, and on the terminal strip for models 40 HP and larger. See [page 36](#) for specific information about dynamic braking.

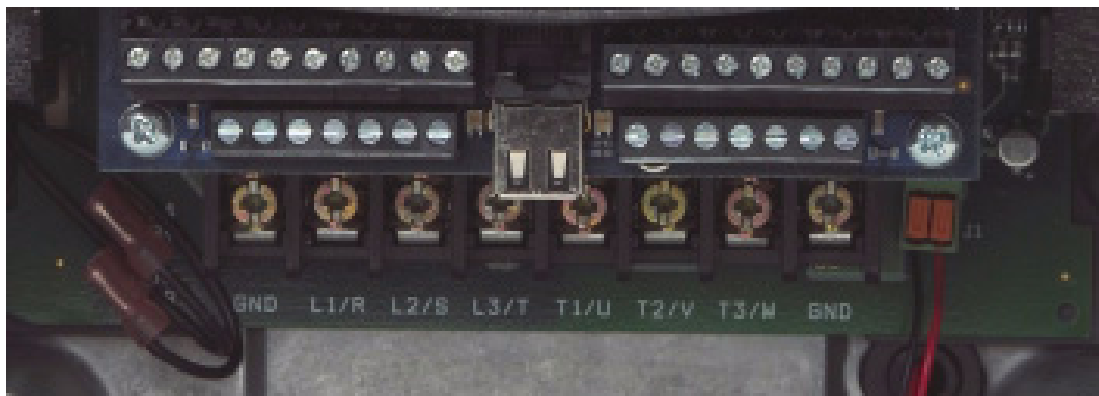
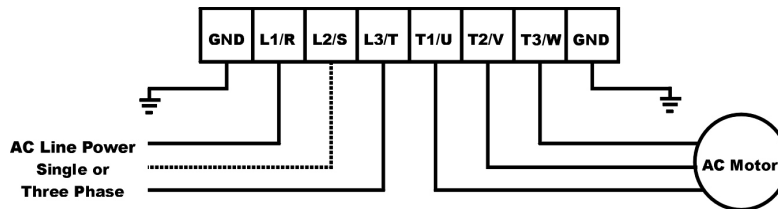

Figure 4-1: X5 Power Terminals



Figure 4-2: Power Terminals on Higher-HP Models

4.4.2 Typical Power Connections

See [Section 4.3](#) starting on page 31 for input line requirements.

Note that when testing for a ground fault, do not short any motor lead (T1/U, T2/V, or T3/W) back to an input phase (L1/R, L2/S, or L3/T).

It is necessary to provide fuses and a disconnect switch for the input AC line in accordance with all applicable electrical codes. The X5 AC drive is able to withstand a 150% overload for 60 seconds for heavy duty rating, and 120% overload for normal duty rating.

The fusing and input protection of the drive must always meet UL, NEC (National Electric Code), and CEC (Canadian Electric Code) requirements. All fuse ratings included in [Table 4-6](#) below are for reference only and do not supersede code requirements. The recommended supplier is Bussman.

Table 4-6: Fuse Ratings (Page 1 of 2)

Model Number	Fuse Size 115 Vac JJS/JJN	Fuse Size 208 Vac JJS/JJN	Fuse Size 230 Vac JJS/JJN	Fuse Size 380 Vac JJS	Fuse Size 460 Vac JJS	Fuse Size 575 Vac JJS
X5C1S010C	20	—	—	—	—	—
X5C20010C	—	10	6	—	—	—
X5C20020C	—	15	10	—	—	—
X5C20030C	—	20	15	—	—	—
X5C20050C	—	30	25	—	—	—
X5C20075C	—	40	35	—	—	—
X5C20100C	—	50	40	—	—	—
X5C20150C	—	70	60	—	—	—
X5C20200C	—	90	80	—	—	—
X5C20250C	—	100	90	—	—	—
X5C20300C	—	125	110	—	—	—

Table 4-6: Fuse Ratings (Page 2 of 2)

Model Number	Fuse Size 115 Vac JJS/JJN	Fuse Size 208 Vac JJS/JJN	Fuse Size 230 Vac JJS/JJN	Fuse Size 380 Vac JJS	Fuse Size 460 Vac JJS	Fuse Size 575 Vac JJS
X5C40010C	—	—	—	6	6	—
X5C40020C	—	—	—	10	6	—
X5C40030C	—	—	—	10	10	—
X5C40050C	—	—	—	15	15	—
X5C40075C	—	—	—	20	20	—
X5C40100C	—	—	—	25	20	—
X5C40150C	—	—	—	40	35	—
X5C40200C	—	—	—	50	40	—
X5C40250C	—	—	—	60	50	—
X5C40300C	—	—	—	80	60	—
X5C40400C	—	—	—	100	80	—
X5C40500C	—	—	—	110	100	—
X5C40600C	—	—	—	125	100	—
X5C40750C	—	—	—	150	125	—
X5C41000C	—	—	—	200	175	—
X5C41250D	—	—	—	225	200	—
X5C41500D	—	—	—	250	225	—
X5C42000D	—	—	—	300	300	—
X5C50010C	—	—	—	—	—	6
X5C50020C	—	—	—	—	—	6
X5C50030C	—	—	—	—	—	10
X5C50050C	—	—	—	—	—	10
X5C50075C	—	—	—	—	—	15
X5C50100C	—	—	—	—	—	20
X5C50150C	—	—	—	—	—	30
X5C50200C	—	—	—	—	—	40
X5C50250C	—	—	—	—	—	50
X5C50300C	—	—	—	—	—	50
X5C50400C	—	—	—	—	—	70
X5C50500C	—	—	—	—	—	80
X5C50600C	—	—	—	—	—	90
X5C50750C	—	—	—	—	—	110
X5C51000C	—	—	—	—	—	150
X5C51250D	—	—	—	—	—	175
X5C51500D	—	—	—	—	—	200
X5C52000D	—	—	—	—	—	250

4.5 Dynamic Braking

The X5 AC drive is supplied with an integrated dynamic braking (DB) resistor, and is designed to have adequate dynamic braking for most applications. In cases where short stopping times or high inertia loads require additional braking capacity, install an external resistor.

Note: For **Size 4** (60-100 HP) and **Size 5** (125-200 HP) models, additional external dynamic braking requires a kit that provides the connections to the braking transistors. The **XDBKITS4** and **XDBKITS5** kits can be purchased through local distributors.

If an external resistor is used for dynamic braking, **the internal resistor must be disconnected**. To install an external resistor, first disconnect the internal DB resistor (or resistors in 460 and 575 Vac models) and properly terminate the wires leading to it. Then connect the external resistor fast-on terminals where the internal resistor had been connected.

Changes to parameter **410** must be made when using external DB resistors.

Verify with the manufacturer of the selected resistor that the resistor is appropriate for your application. Contact Vacon's Electronic Application Engineering group for further assistance with other possible sizing limitations.

Refer to [Table 4-7](#) for information about dynamic braking capacity for each X5 model.

Table 4-7: X5 Dynamic Braking Capacity (Page 1 of 2) (* Note that the asterisked X5 model numbers cannot have external braking added)

Model	KW	Standard Resistance (ohms)	Standard DB (% of Drive Power)	Min. Allowed Res. (ohms)	Max. Peak Watts	Max. Ext. DB (% of Drive Power)
1S010*	.75	125	164%	--	--	--
20010*	.75	125	164%	--	--	--
20020*	1.5	125	82%	--	--	--
20030*	2.2	125	55%	--	--	--
20050	3.7	60	68%	43	3,555	95%
20075	5.5	60	45%	30	5,096	91%
20100	7.5	60	34%	27	5,662	76%
20150	11	60	23%	20	7,644	68%
20200	15	30	34%	10	15,288	102%
20250	18	30	27%	10	15,288	82%
20300	22	30	23%	10	15,288	68%
40010*	.75	500	163%	--	--	--
40020*	1.5	500	82%	--	--	--
40030*	2.2	500	54%	--	--	--
40050	3.7	120	136%	100	6,084	163%
40075	5.5	120	91%	75	8,112	145%

Table 4-7: X5 Dynamic Braking Capacity (Page 2 of 2) (* Note that the asterisked X5 model numbers cannot have external braking added)

Model	KW	Standard Resistance (ohms)	Standard DB (% of Drive Power)	Min. Allowed Res. (ohms)	Max. Peak Watts	Max. Ext. DB (% of Drive Power)
40100	7.5	120	68%	75	8,112	109%
40150	11	120	45%	47	12,944	116%
40200	15	120	34%	47	12,944	87%
40250	18	120	27%	47	12,944	69%
40300	22	120	23%	39	15,600	70%
40400	29.8	60	34%	20	30,420	102%
40500	37.3	60	27%	20	30,420	82%
40600	45	60	23%	15	40,560	91%
40750	55	60	18%	10	60,840	109%
41000	75	60	14%	10	60,840	82%
41250	90	60	11%	10	60,840	65%
41500	110	60	9%	10	60,840	54%
42000	132	60	7%	10	60,840	41%
50010	.75	120	1058%	110	8,607	1154%
50020	1.5	120	529%	110	8,607	577%
50030	2.2	120	353%	110	8,607	385%
50050	3.7	120	212%	110	8,607	231%
50075	5.5	120	141%	91	10,404	186%
50100	7.5	120	106%	91	10,404	139%
50150	11	120	71%	62	15,269	136%
50200	15	120	53%	62	15,269	102%
50250	18	120	42%	62	15,269	82%
50300	22	120	35%	62	15,269	68%
50400	29.8	60	53%	24	39,447	132%
50500	37.3	60	42%	24	39,447	106%
50600	45	60	35%	15	63,115	141%
50750	55	60	28%	15	63,115	113%
51000	75	60	21%	20	63,115	85%
51250	90	60	17%	10	94,672	102%
51500	110	60	14%	10	94,672	85%
52000	132	60	11%	10	94,672	63%

4.6 Terminals Found on the X5 Control Board

4.6.1 Description of the Control Terminals

Figure 4-3 shows the control terminals found on the I/O board of the X5 AC drive. See [page 19](#) for specifications. [Table 4-9 on page 41](#) shows how to use the control terminals for preset speeds.

The drive's control terminals are referenced to earth ground through a resistor / capacitor network. Use caution when connecting analog signals not referenced to earth ground, especially if the communications port (J3) is being used. The J3 port includes a common reference that can be connected to earth ground through the host PLC or computer.



Figure 4-3: X5 Control Terminals

Table 4-8: Description of X5 Control Terminals (Page 1 of 2)

Terminal	Description
Vmet	Analog output 1, which is a dedicated voltage output. The default signal range is from 0 to 10 Vdc (5 mA maximum). It is proportional to the variable configured by parameter 700 (Vmet Config) (see page 91). It may be calibrated while the drive is running via parameter 701 (Vmet Span) (see page 91).
Imet	Analog output 2, which is a dedicated current output. The default signal ranges from 0 to 20 mAdc (50 to 500 Ω). It is proportional to the variable configured by parameter 702 (Imet Config) (see page 92). It may be calibrated while the drive is running via parameters 704 (Imet Offset) and 703 (Imet Span) (see page 92).
Vin1	Analog Input 1, which is used to provide speed references. The default input signal is 0 to 10 Vdc (the type of input signal is selected with parameter 205 (Vin1 Config) ; see page 77). Parameters 206 (Vin1 Offset) and 207 (Vin1 Span) may be used to offset the starting value of the range and the size of the range, respectively; see page 77 for more information. If a 0 to 20 mAdc input signal is configured, the burden is 250 Ω. If a 0 to 10 Vdc input signal is configured, the input impedance is 475 kΩ. A potentiometer with a range of 1 to 10 kΩ is suggested for this input.
+10	This terminal is a +10 Vdc source for customer-supplied potentiometers. The maximum load on this supply cannot exceed 10 mAdc.
Cin+ / Cin-	Current Input. The default input signal is 4-20 mA, although this range may be adjusted by using parameters 209 (Cin Offset) (which configures an offset for the range) and 210 (Cin Span) (to reduce or enlarge the range — for example, setting this parameter to 50% results in a range of 4-12 mA). See page 77 for more information on these parameters. The burden for this terminal is 50 Ω.
Vin2	Voltage Input 2, which is used to provide speed references. The default input signal is 0 to 10 Vdc (the type of input signal is selected with parameter 211 (Vin2 Config) ; see page 78). Parameters 212 (Vin2 Offset) and 213 (Vin2 Span) may be used to offset the starting value of the range and the size of the range, respectively; see page 78 for more information. A potentiometer with a range of 1 to 10 kΩ is suggested for this input.
Acom	Common for the Analog Inputs and Outputs. Note that while there are three Acom (common) terminals, they connect to the same electrical point.
+24	A source for positive nominal 24 Vdc voltage, and has a source capacity of 150 mA.
FWD	Forward Direction Selection terminal. This may be connected for two-wire maintained or three-wire momentary operation.
REV	Reverse Direction Selection Terminal. This may be connected for two-wire maintained or three-wire momentary operation.
R/J	Run/Jog Selector. When this terminal is connected to +24 or common (depending upon Active Logic setting), momentarily connecting either FWD or REV to +24 results in a latched run mode (3-wire operation).
MOL	Motor Overload input terminal. This requires a N/O or N/C contact for operation, referenced to +24 or COM, depending on Active Logic setting.

Table 4-8: Description of X5 Control Terminals (Page 2 of 2)

Terminal	Description
EN	<p>Enable terminal. A jumper is placed between this terminal and the +24 terminal at the factory. You may replace this with a contact, if desired. The circuit from EN to +24 must be closed for the drive to operate.</p> <p>Note that unlike all other terminals, this terminal cannot be configured for "pull-down logic." That is, a high input to this terminal is always regarded as true, and must be present for the drive to operate.</p>
Dcom	Digital Common for use with digital inputs and +24 internal power.
DI1-DI5	<p>Digital inputs.</p> <p>The function of a digital input is configured by the parameter with the same name as the digital input (for example, DI2 is configured by parameter 722 (DI2 Configure); see page 95.</p>
NC1 NO1 RC1	<p>The first auxiliary relay.</p> <p>The function of the relay is set by parameter 705 (Relay 1 Select) (see page 93); the default setting is for the relay to activate when a fault occurs (Drv Fault).</p> <p>Terminal NO1 is the normally-open contact, which closes when the relay is activated. Terminal NC1 is the normally-closed contact, which opens when the relay is activated. Terminal RC1 is the common terminal.</p>
NC2 NO2 RC2	<p>The second auxiliary relay.</p> <p>The function of the relay is set by parameter 706 (Relay 2 Select) (see page 93); the default setting is for the relay to activate when the drive is running (Drv Run).</p> <p>Terminal NO2 is the normally-open contact; it will close when the relay is activated. RC2 is the common terminal.</p>
DO1 DO2	<p>Digital Outputs 1 and 2.</p> <p>The function of the outputs is set by parameters 707 (DO1 Select) and 708 (DO2 Select). The default setting for DO1 is Drive Ready; for DO2 it is At Speed. See page 93.</p>
DOP	<p>Open collector transistor output that supplies a pulse train proportional to speed. The frequency of the output is set by parameter 812 (Freq Ref Output) to either 6x or 48x the running frequency. The output has a maximum rating of 28 Vdc and requires a pull-up resistor (4.7 kOhms) if using the drive's internal supply.</p> <p>Note that if you are using a high-impedance meter to this terminal, the pull-up resistor value may need to change. Please consult the factory for more information.</p>

4.6.2 Typical Connection Diagrams for Digital Inputs

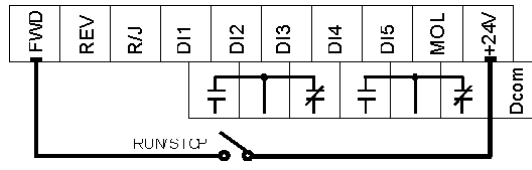

Typical connection for 2-wire control

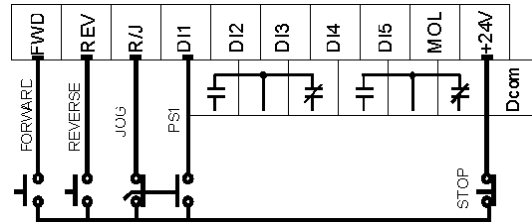

Typical connection for 3-wire control

Figure 4-4: Connections for 2-wire and 3-wire Control

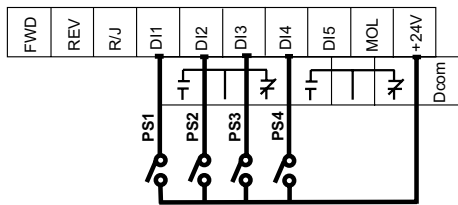

Figure 4-5: Connections for Preset Speeds

Table 4-9: Selection of Preset Speeds

PS4 (Bit 4)	PS3 (Bit 3)	PS2 (Bit 2)	PS1 (Bit 1)	Speed Selected
0	0	0	0	Normal reference speed as defined by parameters 201 (Input Mode) and 204 (Ref Select)
0	0	0	1	Preset frequency F1 (parameter 303)
0	0	1	0	Preset frequency F2 (parameter 304)
0	0	1	1	Preset frequency F3 (parameter 305)
0	1	0	0	Preset frequency F4 (parameter 306)
0	1	0	1	Preset frequency F5 (parameter 307)
0	1	1	0	Preset frequency F6 (parameter 308)
0	1	1	1	Preset frequency F7 (parameter 310)
1	0	0	0	Preset frequency F8 (parameter 311)
1	0	0	1	Preset frequency F9 (parameter 312)
1	0	1	0	Preset frequency F10 (parameter 313)
1	0	1	1	Preset frequency F11 (parameter 314)
1	1	0	0	Preset frequency F12 (parameter 315)
1	1	0	1	Preset frequency F13 (parameter 316)
1	1	1	0	Preset frequency F14 (parameter 317)
1	1	1	1	Preset frequency F15 (parameter 318)

4.6.3 Typical Connection Diagrams for Analog Inputs

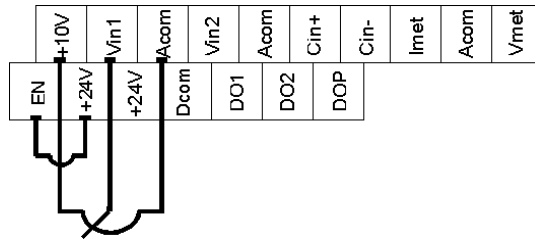

Figure 4-6: Connections for Speed Potentiometer

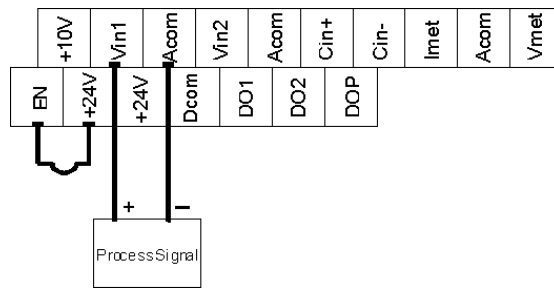

Figure 4-7: Connections for Process Signal

4.6.4 Typical Connection Diagrams for Analog Outputs

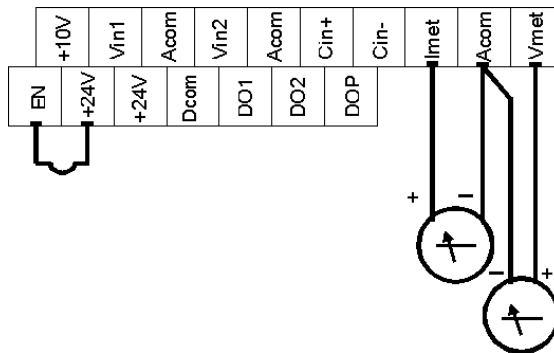

Figure 4-8: Connections for Process Meters

4.6.5 Modbus Connection Diagram



Figure 4-9: RS-485 Connector (Modbus) Pinout

4.7 Reducing Current Surges and Voltage Transients

Inrush currents to coils of magnetic contactors, relays, and solenoids associated with or near the drive can induce high current spikes in the power and control wiring, causing faulty operation. If this occurs, a snubber network consisting of a series resistor and capacitor for AC loads, or a free-wheeling or flyback diode for DC loads, can be placed across the relay coil to prevent this condition. The following component values should be used for 115 VAC or 230 VAC relays or solenoids.

For Main Circuit Contactors and Solenoids
C = 0.2 MFD, 500 VDC R = 500 5 Watts

For Auxiliary Control Circuit Relays
C = 0.1 MFD, 500 VDC R = 200 2 Watts

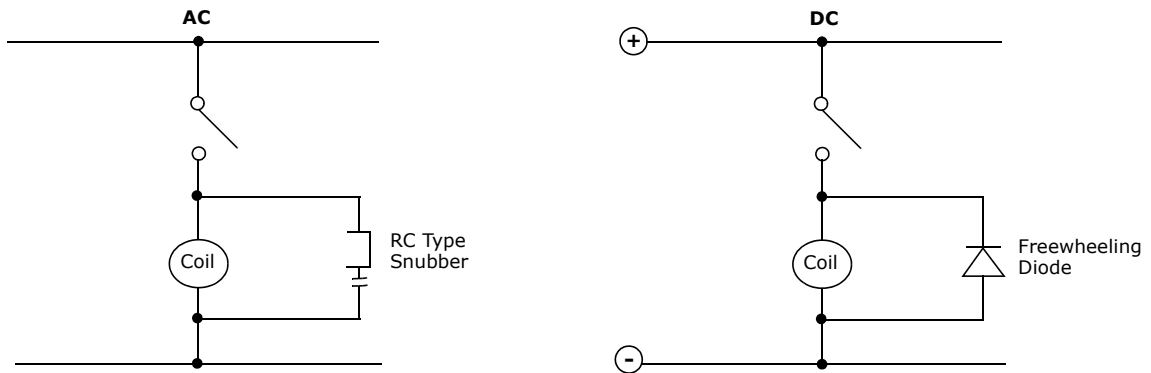

Figure 4-10: Connection Diagram for AC and DC Relay Coils and Solenoids

For magnetic contactors, relays, and solenoids energized from a DC source, use a free-wheeling diode of the high-speed, fast-recovery type. Connect the diode across the coil as shown in [Figure 4-10](#). The diode current and voltage should be selected using the following formulae:

Diode Current Rating (A)	$\frac{\text{Coil Capacity (VA)}}{\text{Rated Voltage of Coil (V)}}$
Diode Voltage Rating	Rated Voltage of Coil (V) x 2

Chapter 5: Operation and Programming

5.1 Introduction

The X5 AC drive is pre-programmed to run a standard, 4-pole AC induction motor. For many applications, the drive is ready for use right out of the box with no additional programming needed. The digital keypad controls all operations of the unit. The ten input keys allow “press and run” operation of the motor (Operation mode) and straightforward programming of the parameters (Program mode)..



Figure 5-1: The X5 Keypad

To simplify programming, the parameters are grouped into three levels:

1. Enter **Level 1** by pressing the Program (PROG) key at any time. Level 1 allows you to access the most commonly used parameters.
2. Enter **Level 2** by holding down the SHIFT key while pressing the PROG key. Level 2 allows access to all X5 parameters, including those in Level 1, for applications which require more advanced features.
3. Enter **Macro mode** by holding the Program (PROG) key down for more than 3 seconds. The display then shows “Hold PROG for Macro Mode.” See [Chapter 6, “Using Macro Mode,”](#) starting on [page 60](#), for more information.

The summary of parameters found before the Table of Contents notes whether a parameter is in Level 1. “[Chapter 7: X5 Parameters](#)” on [page 70](#) gives full information about what level a parameter is in.

Note that all parameters can be addressed by adding 40000 to the parameter number. For example, parameter **201** (Input Mode) can be addressed by Modbus address 40201.

Want to get started fast? See the “Quick Start” section on [page 69](#).

5.2 Keypad Operation

Parameter **201, Input Mode** (see [page 75](#)), determines whether the X5 AC drive accepts its Run/ Stop and speed commands from the digital keypad or from the input terminals. Table 5-1 describes the function of the keys in Operation mode.

Table 5-1: Function of Keys in Operation Mode (X5 Running or Stopped)

	Initiates forward run when pressed momentarily. If the drive is running in reverse when FWD is pressed, it will decelerate to zero speed, change direction, and accelerate to the set speed. The green FWD designation in the key illuminates whenever a FWD command has been given. When both the FWD and REV lights are on, the DC braking function is active.
	Initiates reverse run when pressed momentarily. If the drive is running in forward when REV is pressed, it will decelerate to zero speed, change direction, and accelerate to the set speed. The green REV in the key illuminates whenever a REV command has been issued. When both the FWD and REV lights are on, the DC braking function is active.
	Causes a Ramp-to-Stop when pressed. Programmable to Coast-to-Stop by parameter 401, Ramp Select (page 81). The red STOP indicator in the key illuminates whenever a STOP command has been given. If the drive has stopped because of a fault, this indicator flashes to call attention to the display. The STOP key also functions as a fault RESET key.
	Press the Jog key to enter the Jog mode. The green JOG indicator in the key illuminates when the drive is in the JOG mode of operation. To jog the motor in either direction, press either the FWD or REV key (if REV is enabled in parameter 202). The motor will operate at the speed programmed in parameter 303. To exit the Jog mode, press the Jog key again.
	When the drive is stopped, pressing this key increases the desired running speed. When the drive is running, pressing this key increases the actual running speed in 0.1 Hz increments . Holding the SHIFT key while pressing the INC (UP arrow) key moves the decimal place to the left with each press (0.1 Hz, 1.0 Hz, 10.0 Hz increments).
	When the drive is stopped, pressing this key decreases the desired running speed. When the drive is running, pressing the DEC (down arrow) key decreases the actual running speed in 0.1 Hz increments . Holding the SHIFT key while pressing the DEC key moves the decimal place to the right with each press (10.0 Hz, 1.0 Hz, 0.1 Hz increments).
	<i>NOTE: The operating speed for the drive is stored on Power Down.</i>
	Pressing this key while a parameter is displayed allows that parameter to have its value changed by use of the INC and DEC (up and down arrow) keys. The P indicator flashes to show that the parameter can be programmed. See also the descriptions for the INC and DEC keys to see how they work with the SHIFT key.
	The Enter key has no function when the drive is running or stopped. The Enter key can be used to store the speed command so that it is saved through a power-down. To enable this function, see the description for parameter 802 (Start Options) on page 99.
	Whether the drive is running or stopped, pressing this key places the drive in Program mode. See Table 5-2 on page 46 for more information on how this key functions.
	Pressing this key toggles drive control between the LOCAL and REMOTE control modes, as selected by parameter 201 (Input Mode) . It can be configured to shift: <ul style="list-style-type: none"> the Run/Stop command (either FWD or REV) the speed reference signal both of the above It can also be set to "disabled," which is the factory setting. It will operate either in Stop mode or while the drive is running. If power is removed and reapplied, the memory will retain the last selected function.

You can access **Program mode** is entered by stopping the drive and pressing the **Program (PROG)** key for Level 1 access; or holding down **SHIFT** while pressing **PROG** for Level 2 access. Pressing and holding the **Enter** key and then pressing the **Program** key will show only those parameters that have been changed from the factory defaults. Table 5-2 describes the function of the keys in Program mode.

Table 5-2: Function of Keys in Program Mode









	<p>Press this key to have the drive enter Program mode and have Level 1 parameters available. (To access Level 2 parameters, hold down SHIFT while pressing this key; to access Macro mode, hold down the PROG key for more than 3 seconds.) Once Program mode is active, pressing this key at any time returns the drive to the Operation mode. If an Access Code has been programmed, it must be entered to proceed with programming. See parameter 811 (Access Code) (page 101).</p>
<p><i>NOTE: To see what parameters have changed from the factory default, press ENTER + PROG. If the display flashes "Factory Defaults," no parameters have changed.</i></p>	
	<p>In the Program mode, pressing this key scrolls forward through the parameters. If the P indicator is flashing, it increases the value of the parameter. To change the scroll rate, hold the SHIFT key at the same time to increase the scroll rate; release the SHIFT key to return to the normal scroll rate. Press the ENTER key to store the new value.</p>
	<p>In the Program mode, pressing this key scrolls backward through the parameters. If the P indicator is flashing, it decreases the value of the parameter. To change the scroll rate, hold the SHIFT key at the same time to increase the scroll rate; release the SHIFT key to return to the normal scroll rate. Press the ENTER key to store the new value.</p>
<p><i>NOTE: If the P indicator on the keypad display is flashing, momentarily pressing and releasing both the INC and DEC keys at the same time restores the parameter to the factory default value. Press ENTER to store the new value.</i></p>	
	<p>Pressing this key while a parameter is displayed allows that parameter to have its value changed by use of the INC and DEC (up and down arrow) keys. The P indicator flashes to show that the parameter can be programmed. See also the descriptions for the INC and DEC keys to see how they work with the SHIFT key.</p>
	<p>This key must be pressed after the value of a parameter has been changed to store the new value. The display will show "stored" for one second indicating that the new value has been entered into memory.</p>
<p><i>NOTE: The X5 unit allows you to view only those parameters that have changed. If you press keypad keys ENTER and PROGRAM simultaneously, only those parameters that have been changed from the factory defaults will be shown.</i></p>	

Table 5-3: Function of Keys in Fault Mode

	<p>In Fault mode, pressing the INC (up arrow) and DEC (down arrow) keys allows you to view the drive's status immediately before the fault occurred. Use the INC or DEC keys to scroll through the status parameters. Press the STOP (Reset) key to return to normal operation.</p>
	<p>See "Chapter 8: Troubleshooting" on page 125 for information about viewing Advanced Fault Codes and understanding error codes.</p>
	<p>The red STOP indicator functions as a reset button when in Fault mode. If the drive has stopped because of a fault, this light flashes to call attention to the display.</p>

5.3 LCD Displays

The X5 drive's digital keypad display provides information such as source of drive control, status, mode, and access rights.

5.3.1 Control

The first 3 characters of the display show the source of control for the drive:

Display Values	Meaning
LOC	Local control via the keypad
REM	Remote control from the terminal strip
SIO	Remote control via the RS485 Serial SIO Link
SQx	Control via the Program Sequencer
MEA	The Stator Resistance Measurement is armed

5.3.2 X5 Keypad Status and Warning Messages

Table 5-4 shows X5 keypad status messages that may appear during operation:

Table 5-4: Keypad Status States (Page 1 of 2)

Message	Meaning
Stopped	The drive is not spinning the motor or injecting DC voltage. The drive is ready to run when given the proper signal.
FWD Accel	The drive is spinning the motor in the forward direction and the speed of the motor is increasing.
REV Accel	The drive is spinning the motor in the reverse direction and the speed of the motor is increasing.
FWD Decel	The drive is spinning the motor in the forward direction and the speed of the motor is decreasing.
REV Decel	The drive is spinning the motor in the reverse direction and the speed of the motor is decreasing.
Jog FWD	The drive is jogging in the forward direction.
Jog REV	The drive is jogging in the reverse direction.
FWD At Spd	The drive is spinning the motor in the forward direction and the speed of the motor is at the reference frequency.
REV At Spd	The drive is spinning the motor in the reverse direction and the speed of the motor is at the reference frequency.
Zero Speed	The drive has an active run signal but the motor is not spinning because the reference speed to the drive must be 0.0 Hz.
DC Inject	The drive is injecting DC voltage into the motor.
Faulted	The drive is faulted.
Reset-Flt	The drive is faulted, but has the possibility of being automatically reset.
LS Lockout	Line-Start Lockout functionality has become active. This means there was an active run signal during power-up or when a fault was reset. This run signal must be removed before the Line-Start Lockout functionality will be removed.
Catch Fly	The Catch on the Fly functionality is actively searching for the motor frequency.
Forward	The drive is running forward without accelerating, decelerating or residing at the reference frequency. This means that something is keeping the drive from the reference frequency (for example, Current Limit).

Table 5-4: Keypad Status States (Page 2 of 2)

Message	Meaning
Reverse	The drive is running in reverse without accelerating, decelerating or residing at the reference frequency. This means that something is keeping the drive from the reference frequency (for example, Current Limit).
Not Enabled	The drive is not allowed to run either because the digital input enable is not active or because ARCTIC mode has shut down the run operation.
Volt Range	The drive has not met the input voltage requirements that it needs to be able to run. In other words, the Bus Voltage of the drive is either too low or too high.
Low Voltage	The drive has reached an undervoltage state.
Kpd Stop	A stop command was given from the keypad when the keypad was not the active control source. To remove this condition, the run signal to the drive must be removed.
TOD Inhibit	The drive is not enabled because of time restrictions programmed into the Time of Day parameters.

Table 5-5 shows X5 keypad warning messages that may appear during operation:

Table 5-5: Keypad Warnings

Message	Meaning
DB Active	The DB Resistor is being actively pulsed.
Curr Limit	The drive is operating in current limit.
HS Fan Err	Either the heatsink fan should be on and is off, or vice-versa.
Addr XXX	This is the node address of the drive when it receives a valid message through the IR port address to another node. The XXX will be replaced with the node address.
High Temp	The temperature of either the heatsink or the control board is nearing a high temperature limit that will fault the drive.
Low Temp	The temperature of either the heatsink or the control board is nearing a low temperature limit that will fault the drive.
Vac Imblnce	Either the drive has lost an input phase or the input voltage is unbalanced more than 2%.
Power Supp	A power supply short occurred.
Seq Dwell	The sequencer is active, but the transition to the next step is halted.
Int Fan Err	Either the internal fan is on and should be off, or vice-versa.
DB OverTemp	The temperature of the DB Resistor is nearing a high temperature and will fault the drive.
ARCTIC Mode	The ARCTIC DB Resistor mode is actively pulsing the DB Resistor.
CPU Warning	A system error occurred in the software of the X5.
Mtr Measure	An RS Measurement is armed or active.
IR Active	Valid IR communications are occurring.
Seq Running	The program sequencer functionality is active.
Clock Error	The clock does not have the proper time programmed into it, or there is a problem communicating with the RTC chip.
Battery Low	The drive has detected that the RTC chip's battery is getting low.
Op BD Found	The drive has detected that an option board is now connected.

5.3.3 Rights

After Program mode is entered, the operator's access rights are displayed:

Display Values		
ACCESS RIGHTS	P	This indicates that while in Programming mode, parameter data can be changed.
	V	If the drive is in Run mode (FWD or REV) when the PROG key was pressed, parameters can be viewed, but not changed.
	The first character of the second line indicates if the particular parameter can be changed (P) or only examined (V). If an attempt is made to change data while in the View (V) mode, the message **NO ACCESS** will appear for one second.	

5.3.4 Other Data

The top line gives 16-character description of the parameter being accessed. The parameter number will flash when data is being changed. Up to 10 characters are used to display the information stored in the parameter. Some parameters have a unit designator such as:

s	Seconds
h	Hours
C	Degrees centigrade
Hz	Hertz
%	Percent
A	Amperes

When the drive stops because of a fault trip, a unique error message will be displayed, along with the flashing STOP indicator. "Pages," or screens of information are available concerning the actual fault and drive status.

["Chapter 8: Troubleshooting" on page 125](#) gives information about fault codes and troubleshooting.

5.4 Keypad Display Window

The keypad display window provides information on drive operation and programming. Special symbols provide further information about drive operation (see the following section). [Figure 5-2](#) shows an example of the X5 keypad display window.

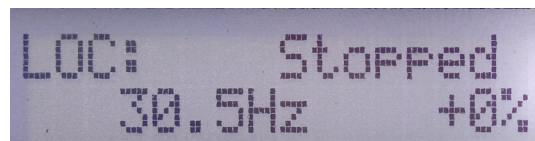

Figure 5-2: X5 Keypad Display Window

5.5 Programming

5.5.1 Accessing Parameters

When **PROG** (or **SHIFT+PROG**) is pressed after application of power or a fault reset, [parameter 201, Input Mode](#), is always the first parameter displayed. [Figure 5-3](#) shows a typical programming display.

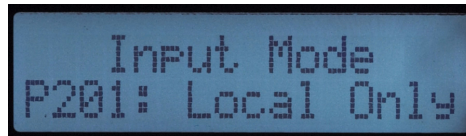

Figure 5-3: Typical Programming Display

If a different parameter is accessed and Program mode is exited, that parameter is the first one displayed the next time Program mode is entered. The drive remembers a different “last parameter accessed” for Levels 1 and 2.

5.5.2 Changing the Display Scroll Rate

Pressing the **INC** or **DEC** (up or down arrow) keys causes the display to scroll at a slow rate. To increase the scroll rate, hold the **SHIFT** key at the same time that you press the **INC** key. Release the **SHIFT** key to return to the slow scroll rate. This procedure works in all programming and operation modes.

5.5.3 Programming Procedure

To program the value of a parameter, follow these steps:

1. Press the Program (**PROG**) key to enter Level 1 Program mode. To enter Level 2, press **SHIFT+PROG**. The P indicator will appear on the display. You must enter one level of programming or the other; you cannot switch between levels without exiting Program mode.

Note that some parameters cannot be changed in Run mode. For example, if you wish to program [parameter 201, Input Mode](#), you must stop the drive before beginning programming. Refer to the [Parameter Summary table](#) at the front of this manual to see which parameters cannot be changed in Run mode (they appear as shaded entries in the table).

2. Press the **INC** or **DEC** (up or down arrow) keys to access the desired parameter.
3. Press the **SHIFT** key to allow the value to be changed. The P indicator starts to blink.
4. Press the **INC** or **DEC** key to select the new value.
5. Press the **ENTER** key to store the new value. The display shows “Stored” for one second.
6. Press **PROG** to exit Program mode, or the **INC** or **DEC** keys to select a new parameter.

To program a text parameter, follow these steps:

1. Like other parameters, text parameters use the **INC/DEC** (up/down arrow) and **SHIFT** keys for editing. A line appears under the character that you are changing.
2. Press **SHIFT** to advance to the next character that you want to change.
3. Use the **INC** or **DEC** keys to change the character value.
4. Press **ENTER** to store the edited text.

5.5.4 Restoring Factory Settings

Whenever a parameter's value is being changed (noted by the P indicator flashing), the original factory setting for that parameter may be restored by pressing and releasing both the INC or DEC keys simultaneously and then pressing the ENTER key.

To restore ALL parameters to factory settings, or to recall a previously stored parameter set, see [parameter 801, Program Number](#) (page 99).

5.5.5 Viewing Parameters That Have Changed

The X5 unit allows you to view only those parameters that have changed. If you press **ENTER** and **PROG** keys simultaneously, only those parameters that have been changed from the factory defaults will be shown. Note that all parameters, regardless of Level 1 or 2 default location, will be shown. If other parameters need to be changed, press the **PROG** key to exit this mode.

5.5.6 Using Macro Mode

A special Macro programming mode is available with the X5 series of AC drives. The Macro programming mode allows you to customize the most common parameters for your application in the Level 1 group. Macro mode provides parameters for activating special features like the program sequencer or serial communications, plus a means of easily entering important motor parameters.

Parameters that are important to the drive's operation are also included in the Macro mode. Although these parameters are also available with standard programming, the Macro mode allows you to quickly and easily configure the drive with essential parameters.

See "[Chapter 6: Using Macro Mode and Getting a Quick Start](#)" on page 60, for detailed information about using macros to program the X5 drive.

5.6 Measuring Stator Resistance (RS Measurement)

5.6.1 Activating Automatic RS Measurement via Keypad

1. Make sure there is no load applied to the motor and that the motor shaft is free to spin without damage or injury.
2. Enter the Macro programming mode of the X5 keypad by pressing and holding the PROG key until the parameter "Appl Macro" appears on the keypad. This takes about two seconds.
3. Scroll through the parameters of the X5 Macro programming mode and configure the following parameters to the data provided on the nameplate of the motor:
 - [Rated Volt \(509\)](#)
 - [Rated Mtr FLA \(510\)](#)
 - [Rated Mtr RPM \(511\)](#)
 - [Power Factor \(515\)](#)
4. Change [parameter 519 \(Find Mtr Data\)](#) to a value of "Motor RS." At this point, the RS Measurement will be armed.
5. Exit the Macro programming mode by pressing the **PROG** key.
6. The Operate screen shows in two ways that an RS Measurement is ready to be made. First, the Control path status field displays "MEA." Second, a "Mtr Measure" warning flashes, both of these signifying that a measurement is about to be taken.
7. Start the RS Measurement by pressing the **FWD** key. The measurement can only be made with the **FWD** key. The FWD / REV terminals and the **REV** key will not work.
8. The measurement will begin as the drive injects voltage to the motor at zero frequency. The test lasts about two seconds.

9. If the test was successful, the drive will stop and return to the configured control path. The “Motor RS” parameter will contain a new value that is the calculated resistance of the motor.
10. If the test was not successful, the drive will fault with a “RS Meas. Fail” message (Fault 34). If the test fails, you may want to try the test again with a different “Rated Mtr FLA” or different Current Limit percentage.

5.6.2 Activating Automatic RS Measurement via Serial Link (Modbus)

1. Make sure there is no load applied to the motor and that the motor shaft is free to spin without damage or injury.
2. Configure the following parameters to the data provided on the nameplate of the motor:
 - [Rated Volt \(509\)](#)
 - [Rated Mtr FLA \(510\)](#)
 - [Rated Mtr RPM \(511\)](#)
 - [Power Factor \(515\)](#)
3. Change [parameter 519 \(Find Mtr Data\)](#) to a value of “Motor RS.” At this point, the RS Measurement will be armed.
4. Start the RS Measurement by writing a value of 0x0007 to parameter [904 \(SIO Cntl Word\)](#).
5. The measurement begins as the drive injects voltage to the motor at zero frequency. The test lasts about two seconds.
6. If the test was successful, the drive will stop and return to the configured control path. The “Motor RS” parameter will contain a new value that is the calculated resistance of the motor.
7. If the test was not successful, the drive will fault with a “RS Meas. Fail” message (Fault 34). If the test fails, you may want to try the test again with a different “Rated Mtr FLA” or different Current Limit percentage.

5.7 Storing Data and Reflashing Using a Flash Memory Device

You can use a flash memory stick (sometimes called a jump drive, thumb drive, or flash drive) with the USB port on the X5. In this way, software, program parameters and Keeper data can be stored easily. The file type for drive parameters is the same as used by PDA-trAC Plus with an extension of **.tps**. When stored, the file is identified with the name assigned in [parameter 794](#). Keeper data files have an extension of **.csv**.

5.7.1 Storing Drive Parameters

1. Insert the memory stick in the USB port.
2. Access [parameter 799 \(Config USB Mode\)](#) in Level 2 programming.
3. Select **Par. Store** and press the **INC** key.
4. The display indicates the file name that will be stored and that you should press **SHIFT** to proceed.
5. Follow the prompts on the screen and when the memory write is complete, the display indicates that you should press the **DEC** key to finish.

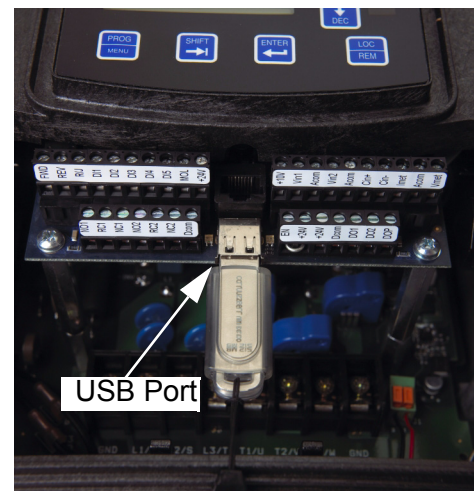

X5 Terminals and USB Port

6. Pressing the **DEC** key completes the store process. You will be returned to parameter **799**, and the value reverts to the default state of “disabled.”
7. Remove the memory stick. The parameter data is now stored.

5.7.2 Recalling Drive Parameters

1. Insert the memory stick in the USB port.
2. You will need to know the file name that you want to access, particularly if there is more than one **.tps** file on the memory stick.
3. Access [parameter 799 \(Config USB Mode\)](#) in Level 2 programming.
4. Select **Par. Recall** and press the **INC** key.
5. The display indicates a file name, and that you should press **SHIFT** to proceed. Verify that the file name is the one you wish to recall before pressing **SHIFT**.
6. After you have selected the file you want, press **ENTER** to continue.
7. Follow the prompts on the screen. When the recall is complete, the display indicates that you should press the **DEC** key to finish.
8. You will be returned to parameter **799**, and the value reverts to the default state of “disabled.”
9. Remove the memory stick.

5.7.3 Storing Keeper Files

1. Insert the memory stick in the USB port.
2. Access [parameter 799 \(Config USB Mode\)](#) in Level 2 programming.
3. Select **Keeper Dump** and press the **INC** key.
4. The display indicates a file name that will be stored and that you should press **SHIFT** to proceed.
5. Follow the prompts on the screen. When the memory write is complete, the display indicates that you should press the **DEC** key to finish.
6. The file extension for a “keeper dump” file is **.csv**.
7. You will be returned to parameter **799**, and the value reverts to the default state of “disabled.”
8. Remove the memory stick.

5.7.4 Reflashing the X5 Using the USB Port and a Flash Memory Device

You may find it convenient to be able to reflash the X5 memory and load new software. This is possible to do via the USB port and a memory stick to which you have copied the software.

1. On startup, press and hold the **STOP** key while pressing **PROG** to access the X5 Bootloader. The Bootloader screen shown below appears:

```

B o o t l o a d e r   X 5 . 0 6
W a i t i n g   f o r   D a t a

```

2. To enter USB Reflash mode, press the **PROG** key. The following screen appears:

```

U S B   R e f l a s h ? : U P
                A b o r t : D N

```

3. Insert the memory stick into the USB port.
4. Verify that you want to reflash via USB by pressing the **INC** key, or cancel the reflash by pressing the **DEC** key.

- Pressing **INC** causes power to be applied to the USB port, so ensure that there is no connection to that port. If you press the **DEC** key, the reflash procedure is cancelled.
- When you press the **INC** key, one of four screens will appear. The LED next to the USB port will flash red until a connection is made to the memory stick. During this state, the drive displays the message shown below:

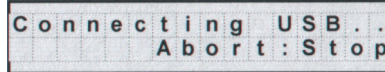

- When a connection to the memory stick is made, the LED will turn solid green and the display will be one of the three screens below.

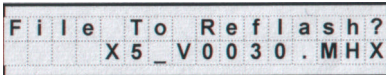

If an .MHX file is found in the root directory, this screen appears.



If no .MHX file is found, this screen appears if a directory is found. Directories are shown in brackets.

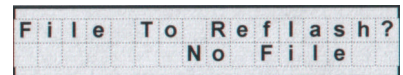

If no .MHX file and no directory is found, this screen appears.

If a file name is more than 12 characters long, the name is truncated on the display.

If the drive does not connect successfully to the USB memory stick, remove and re-insert the stick.

- Navigate to the desired .MHX file by using the **INC**, **DEC**, **SHIFT+INC**, **SHIFT+DEC** key combinations. Press the **ENTER** key to select the file. **INC** and **DEC** keys scroll through the files in the current directory in the memory stick. Pressing **SHIFT+INC** or **SHIFT+DEC** navigates through directories.
- Wait for the reflash process to complete. The X5 display shows the progress of the reflash:

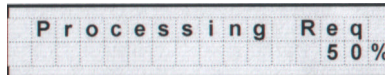

Reflash time depends on the quality and speed of the memory stick used. Expect at least 8 minutes for the reflash process to complete.

- Results of the reflash are shown in the display, and depending on the results, you will see different things. If the reflash is successful, the X5 software will show the normal X5 display. If unsuccessful, the following screen appears:



The number after "Request Failed" tells why the failure occurred:

- 0 = User aborted process
- 1 = Cannot open file
- 2 = Corrupted file

- Press the **STOP** key to reset the Bootloader.

5.8 Using the Keeper Data Log

The X5 provides a data collection utility called the “Keeper.” This function accumulates time-based data during a specific period of time. For example, you might need to determine how many gallons of liquid have been pumped, how many feet of material have been processed, or how many “widgets” have been produced in a given time period. The Keeper collects this kind of data for you, in 8-, 12-, or 24-hour periods of time. The Keeper also logs the kilowatt hours the drive has delivered to the motor during the recording period, which can help you determine peak energy times for your process.

To use the Keeper, you need to attach a sensor to an analog input or to the encoder feedback signals. The sensor should provide a signal that represents the rate at which you are performing a task. The signal should be compatible with the input range of the analog input or encoder. Set up a few parameters that tell the drive the input scaling of the sensor, the rate information, and the times in which you want to capture the data, and the Keeper does the rest. The data can be stored and retrieved on a USB flash memory device, in a .csv file format that makes it possible to import directly into a spreadsheet. See “[Storing Keeper Files](#)” on [page 53](#) for instructions on how to store Keeper data on a USB memory stick.

5.8.1 Keeper Parameters

The following table shows the Keeper parameters and a brief description of their functions. For their options and defaults, please refer to [page 79](#).

Table 5-6: Keeper Parameter Descriptions

Parameter	Parameter Name	Description
380	Keeper Input Cfg	Configures how the Keeper function gets its input and also enables the Keeper function.
381	Keeper Max Scale	Configures the value of the Keeper input signal when the analog input is at its maximum value.
382	Keeper Save Time	Sets the time of each day that the Keeper will save an accumulated process variable.
384	Keeper Save Rate	Configures whether the Keeper will collect multiple records during a day.
385	Keeper Input	Provides feedback to display the current value of the Keeper input.
386	Keeper Time Rate	Configures the time base of the Keeper accumulation. The setting of this variable is dependent on the process variable.
387	Keeper Rec. Num	Shows how many records have been saved by the Keeper.
388	Active Kpr Rec.	Shows the active Keeper record.
389	Keeper Units	Configures the units of the Keeper input.

The maximum number of records that the Keeper can store before data is overwritten is 128. If you select “24 Hour” as the rate, you can keep 128 days of information; “12 Hour” allows 64 days; “8 Hour” allows 32 days.

5.8.2 Setting up the Keeper Function

To set up the Keeper function, follow these steps:

1. Make the Keeper parameters visible by changing parameter **150 (Show Clock Parameters)** to a value of **Yes**.
2. Make sure that the correct date and time are displayed in **parameters 120 (Today's Date)** and **121 (Today's Time)**.
3. Choose which analog input channel will be used as the input signal to the Keeper. Set up the analog input channel for the proper analog input configuration. Note that you can also set up an input from an encoder as the input to the Keeper function.
4. Program **parameter 380 (Keeper Input Cfg)** to the value that is the input signal you chose for the Keeper function.
5. Choose the units to be used by the Keeper by changing **parameter 389 (Keeper Units)** to the desired units. The default is **GPM**; if you want that unit, you can skip this step. If the option for units is not available, you can choose to program the engineering units of the drive as the units of the input function. Do this by selecting **User Units** for the **Keeper Units** parameter and programming **parameter 805 (Display Units)** to the text you want.
6. Modify **parameter 381 (Keeper Max Scale)** to the value to be displayed with the analog input sensor is at its maximum value. For example, if you are using a 4-20 mA sensor and it produces an output of 0-1000 GPM, then you should configure the analog input to 4-20 mA and set parameter **381** to a value of 1000. This value should represent the maximum of your sensor.
7. Verify that the Keeper input signal is scaled correctly. Do this through **parameter 385 (Keeper Input)**. This parameter should be displaying the value the sensor is outputting. Make sure that this value has been scaled correctly.
8. Configure the times that the Keeper will save data. To do this, decide whether you want the Keeper to save data once, twice, or three times a day. Program this choice into **parameter 384 (Keeper Save Rate)**. If you want the Keeper to save data once a day, select **24 hour**. Twice a day would be **12 hour**; three times a day would be **8 hour**.
9. Program the *exact time* that the Keeper will save data. Do this by programming a time value into **parameter 382 (Keeper Save Time)**. The Keeper will save the total value of the processed variable every 8 or 12 or 24 hours, depending on your selection in **Keeper Save Rate**.
10. Now program the rate of the input variable using **parameter 386 (Keeper Time Rate)**. The selection of this parameter should be made based on the units you are accumulating. For example, if you are pumping gallons per minute (GPM), program this parameter to **minute**. If you are pumping liters per second, program **second**. The parameter should match the time base of the units you are accumulating.
11. The Keeper is now set up and ready to collect data. The last step should be to reset the records to be collected. Depending on the order of parameters programmed, you may have false data in your initial records. To reset the records, navigate to **parameter 801 (Program Number)** and enter a value of 40. This will reset the Keeper records so that valid data can be collected. The Keeper will collect data until the first save time that you have programmed into the drive.

This data will be saved in a partial data record that you will be able to determine from the number of minutes accumulated.

12. You can extract the Keeper records from the drive with a USB flash memory device or memory stick. (See “[Storing Keeper Files](#)” on page 53.) When you extract the data from the drive, it will be presented to you in a comma-separated file (.csv) that can be opened in Excel. The format of the data will be as follows:

DATE	TIME	DAY	GALLONS	PERIOD(MINS)	KWHOUR
1/1/2000	0:00	Fr	10000	480	500

The **Date** and **Time** represent the time the data was saved to the record. In this case, the units of the Keeper function were configured to be **GPM**. The fourth column then indicates the number of gallons pumped during the period ending at the Date and Time indicated. If you were to configure the Keeper to units of **LPS**, this field would indicate Liters. The period field indicates the number of minutes the drive was available to run during that period. The **KWHour** field allows you to determine what energy was supplied to the drive during the period.

5.9 Using the X5 Real-Time Clock and Other Special Features

If you use [parameter 150 \(Show Clock Param\)](#) to access the functionality of the X5 real-time clock, a wide range of features is available. To do this, first change parameter **150** in Level 2 programming mode to **Yes**.

5.9.1 Enabling the X5 Based on Time of Day (TOD)

The X5 includes two “enable” windows that can control when the drive is allowed to run during the course of a work day, Monday through Friday, and an additional “enable” window for weekends. To use this enable function, select the time in your time zone ([parameter 151, Time Zone Setup](#)) and the clock hour in 24-hour military time for both enable and disable times. The following table shows both weekday enable functions and the additional weekend function (Saturday and Sunday), and which parameters can be set for the time frame.

	Parameter Number	
	Enable (Start)	Disable (Stop)
Enable Function #1 (Weekday)	152	154
Enable Function #2 (Weekday)	156	158
Enable Function #3 (Weekend)	160	162

These TOD enable functions allow the drive to operate unattended for long periods of time and to turn off equipment when not needed, eliminating the need to remember to shut the equipment off. The drive can also be operated when power costs are generally lower, adding to the overall efficiency of the application. Over time, this set of functions can result in substantial savings.

It should be noted that in spite of the automation feature, the drive can be manually overridden (to operate when not enabled, perhaps for maintenance) by using a suitably programmed digital input. It is also possible to transmit the information that the drive is being overridden, via one of the digital outputs. Note that the drive must receive a normal RUN command during the enabled period for it to operate.

5.9.2 Reminders

The X5 also allows you to set up three reminders, based on real time. While they are fundamentally time-based, they can be based also on drive run time, or enabled or “gated” time. Reminders can be helpful for maintenance technicians or operators.

Gated time is roughly equivalent to a “lap” time if you’re running a race, where time is only counted while a certain condition is true. That is, while a digital input is active, the timer is gating. If it is no longer active, gating stops.

When a reminder has timed out, a digital output can be activated to warn the operator or maintenance technician that a certain action must be taken, such as regular maintenance or cycling of some element in the process.

A reminder’s time-out can also be monitored from the keypad (through the **ETA** parameters: [173](#), [176](#), [179](#) on page 74) and reset remotely, again through a digital input.

The parameters associated with reminder configuration are:

	Parameter Number		
	Configuration	Time	Time to Completion
Reminder #1	171	172	173
Reminder #2	174	175	176
Reminder #3	177	178	179

See [page 74](#) for information on how to program digital inputs and outputs to work with reminders.

5.9.3 Timers

The X5 can also act as a timer. It actually has two timers available (parameters [746](#), [749](#)). Each timer can look at any signal normally presented to a digital input and delay its function by a set value (in seconds). You may also choose to delay the transition in turning off the function--that is, you can configure a digital output to delay on, delay off, or both, for any function presented normally to a digital input.

This kind of functionality is often critical to coordinating the operation of more than just the motor driven by the X5. You may even be able to eliminate the need for a PLC to control a complete operation, if you can utilize more of the built-in functionality of the X5.

The parameters associated with timer configuration are:

	Parameter Number		
	Timer Type	Timer Signal	Timer “Time”
Timer #1	746	747	748
Timer #2	749	750	751

5.9.4 Thresholds

Another X5 feature related to digital outputs and overall machine coordination is the threshold function. The X5 provides two thresholds that can be used to trigger a digital output to control other equipment based on the conditions measured at one of the analog inputs or overall drive conditions. It doesn’t matter if the analog input is controlling the X5 or not; the X5 is simply measuring the input and can transmit the condition of the signal associated with it.

Thresholds can look at conditions within the drive, such as load, output power, current, or (with the help of an encoder board) an encoder frequency or speed signal. You can set limits of high, low, and within range for the condition to be considered true for a digital output.

The parameters associated with each threshold function are:

	Parameter Number		
	Select (function)	Threshold High Limit	Threshold Low Limit
Threshold #1	740	741	742
Threshold #2	743	744	745

Chapter 6: Using Macro Mode and Getting a Quick Start

A special Macro programming mode is available with the X5 series of AC drives. The Macro programming mode allows you to customize quickly the most common parameters for your application in the Level 1 group. Macro mode provides special parameters for activating modes of operation by macros, program sequencer, or serial communications.

Parameters important to the drive's operation are also included in Macro mode. Although these parameters are also available with standard programming, the Macro mode allows you to easily configure the drive with essential parameters.

Macros configure what advanced functions will be active in the drive. A macro can also change the default or visibility of a parameter within the programming levels. **Parameter 490 (Appl Macro)** configures what macro will be active in the drive. **Parameter 491 (Seq Appl)** configures the visibility of sequencer parameters and the time base of the sequencer. **Parameter 492 (SIO Visible)** configures whether or not SIO parameters are visible. (See [page 61](#).)

Note that all parameters can be addressed by adding 40000 to the parameter number. For example, parameter **201** (Input Mode) can be addressed by Modbus address 40201.

6.1 Entering Macro Mode

To enter the Macro mode, press and hold the PROGram key for more than three seconds. The drive then enters Macro mode and displays "Hold PROG for Macro Mode." Following is a list of the different macros available and their features. A description of parameters used in Macro mode begins on page 61.

Factory	The Factory macro provides a simple way to restore the factory default parameter listings.
Fan	The Fan macro provides a basic set-up for Fan applications. Parameters such as the V/Hz curve and terminal strip operation are available in Level 1 programming.
Fan w/ PI	The Fan w/ PI macro allows for a simple set-up for Fan applications requiring process control. Parameters such as the V/Hz curve, terminal strip operation, and PI configuration parameters are available in Level 1 programming.
Pump	The Pump macro provides a basic set-up for Pump applications. Parameters such as the V/Hz curve and terminal strip operation are available in Level 1 programming.
Pump w/ PI	The Pump w/ PI macro allows for a simple set-up for Pump applications requiring process control. Parameters such as the V/Hz curve, terminal strip operation, and PI configuration parameters are available in Level 1 programming.
Vector	The Vector macro activates the sensorless vector control algorithm. When an operation requires low speed and high torque, this macro should be activated.

6.2 Description of Parameters Used in Macro Mode

Parameters **490, 491, and 492** are used only in the Macro mode. Parameters **509, 510, 511, 801, and 810** are used in both Macro and Level 2 programming. X5 parameters are described in “Chapter 7: X5 Parameters” on page 70 of this manual.

490 Appl Macro	Default: Factory	Range: n/a Macro														
<p>This parameter configures what macro will be active in the drive. A macro will change a default or visibility of a parameter.</p> <p>The following data values may be assigned to this parameter:</p> <table border="1"> <thead> <tr> <th><u>Macro</u></th> <th><u>Description</u></th> </tr> </thead> <tbody> <tr> <td>Factory</td> <td>Provides a simple way to restore factory default parameter listings.</td> </tr> <tr> <td>Fan</td> <td>Provides a basic set-up for Fan applications, including V/Hz curve and terminal strip operation in Level 1 programming.</td> </tr> <tr> <td>Fan w/PI</td> <td>Provides a simple set-up for Fan applications that require process control. Parameters such as V/Hz curve, terminal strip operation, and PI configuration are available in Level 1 programming.</td> </tr> <tr> <td>Pump</td> <td>Provides a basic set-up for Pump applications, including V/Hz curve and terminal strip operation in Level 1 programming.</td> </tr> <tr> <td>Pump w/PI</td> <td>Provides a simple set-up for Pump applications requiring process control. Parameters such as V/Hz curve, terminal strip operation, and PI configuration are available in Level 1 programming.</td> </tr> <tr> <td>Vector</td> <td>Activates the sensorless vector control algorithm. When an operation requires low speed and high torque, this macro should be activated. Note that when you select Vector mode, the drive automatically runs the Motor RS Measurements when leaving Program mode.</td> </tr> </tbody> </table>			<u>Macro</u>	<u>Description</u>	Factory	Provides a simple way to restore factory default parameter listings.	Fan	Provides a basic set-up for Fan applications, including V/Hz curve and terminal strip operation in Level 1 programming.	Fan w/PI	Provides a simple set-up for Fan applications that require process control. Parameters such as V/Hz curve, terminal strip operation, and PI configuration are available in Level 1 programming.	Pump	Provides a basic set-up for Pump applications, including V/Hz curve and terminal strip operation in Level 1 programming.	Pump w/PI	Provides a simple set-up for Pump applications requiring process control. Parameters such as V/Hz curve, terminal strip operation, and PI configuration are available in Level 1 programming.	Vector	Activates the sensorless vector control algorithm. When an operation requires low speed and high torque, this macro should be activated. Note that when you select Vector mode, the drive automatically runs the Motor RS Measurements when leaving Program mode.
<u>Macro</u>	<u>Description</u>															
Factory	Provides a simple way to restore factory default parameter listings.															
Fan	Provides a basic set-up for Fan applications, including V/Hz curve and terminal strip operation in Level 1 programming.															
Fan w/PI	Provides a simple set-up for Fan applications that require process control. Parameters such as V/Hz curve, terminal strip operation, and PI configuration are available in Level 1 programming.															
Pump	Provides a basic set-up for Pump applications, including V/Hz curve and terminal strip operation in Level 1 programming.															
Pump w/PI	Provides a simple set-up for Pump applications requiring process control. Parameters such as V/Hz curve, terminal strip operation, and PI configuration are available in Level 1 programming.															
Vector	Activates the sensorless vector control algorithm. When an operation requires low speed and high torque, this macro should be activated. Note that when you select Vector mode, the drive automatically runs the Motor RS Measurements when leaving Program mode.															
491 Seq Appl	Default: Disabled	Range: n/a Macro														
<p>This parameter configures sequencer parameters are visible and the time base of the sequencer. The time base may change depending on the timing loops used.</p> <p>The following data values may be assigned to this parameter:</p> <table border="1"> <thead> <tr> <th><u>Macro Value</u></th> <th><u>Description</u></th> </tr> </thead> <tbody> <tr> <td>Disabled</td> <td>Sequencer disabled and parameters hidden.</td> </tr> <tr> <td>1sec Base</td> <td>Sequencer enabled and 1 second time base.</td> </tr> <tr> <td>.1sec Base</td> <td>Sequencer enabled and 0.1 second time base.</td> </tr> <tr> <td>.01sec Base</td> <td>Sequencer enabled and 0.01 second time base.</td> </tr> </tbody> </table>			<u>Macro Value</u>	<u>Description</u>	Disabled	Sequencer disabled and parameters hidden.	1sec Base	Sequencer enabled and 1 second time base.	.1sec Base	Sequencer enabled and 0.1 second time base.	.01sec Base	Sequencer enabled and 0.01 second time base.				
<u>Macro Value</u>	<u>Description</u>															
Disabled	Sequencer disabled and parameters hidden.															
1sec Base	Sequencer enabled and 1 second time base.															
.1sec Base	Sequencer enabled and 0.1 second time base.															
.01sec Base	Sequencer enabled and 0.01 second time base.															
492 SIO Visible	Default: No	Range: n/a Macro														
<p>This parameter configures whether SIO parameters are visible.</p> <p>The following data values may be assigned to this parameter:</p> <table border="1"> <thead> <tr> <th><u>Macro Value</u></th> <th><u>Description</u></th> </tr> </thead> <tbody> <tr> <td>No</td> <td>SIO parameters hidden.</td> </tr> <tr> <td>Yes</td> <td>SIO parameters visible.</td> </tr> </tbody> </table>			<u>Macro Value</u>	<u>Description</u>	No	SIO parameters hidden.	Yes	SIO parameters visible.								
<u>Macro Value</u>	<u>Description</u>															
No	SIO parameters hidden.															
Yes	SIO parameters visible.															
509 Rated Mtr Volt	Default: Model dependent	Range: 100 V - 690 V Level 2, Macro														
<p>The Rated Motor Voltage parameter configures the rated motor voltage, and allows a user to enter the rated voltage from the motor nameplate to provide optimal control and protection. This is usually the amount of voltage delivered to the motor terminals at the setting of 503 (V/Hz Knee Freq).</p>																
510 Rated Mtr FLA	Default: ND Rating	Range: 50% of ND rating - 200% of ND rating Level 2, Macro														
<p>The Rated Motor FLA parameter allows a user to enter the rated FLA from the motor nameplate to provide optimal control and protection. This parameter should be configured to the value on the nameplate of the motor, as that value is used in calculating the percentage of current at which the drive is operating.</p> <p>For information on motor timed overload operation, and how Parameter 510 works with it, see page 86.</p>																

511 Rated Mtr RPM	Default: 1750 rpm	Range: 0-24000 rpm Level 2, Macro
This parameter replaces the slip compensation parameter setting of the drive so the user does not need to calculate it.		
514 Motor RS	Default: 1.00 Ohm	Range: 0.00-655.35 Ohms Level 2
This parameter allows direct entry of the Stator Resistance (Rs) of the motor for better vector performance. The motor manufacturer can provide this information. See "Measuring Stator Resistance (RS Measurement)" on page 51.		
515 Power Factor	Default: 0.80	Range: 0.50 - 1.00 Level 2
This parameter allows direct entry of the motor's power factor for better vector performance. The motor manufacturer can provide this information.		
794 Drive Name	Default: 0	Range: n/a Level 2
This parameter is an alphanumeric name associated with the drive. Note that files stored in a flash memory device (using parameter 799) will have a filename associated with parameter 794 (Drive Name).		
801 Program Number	Default: 0	Range: 0 to 9999 Level 2, Macro
This parameter (Special Program Number) provides a method of enabling hidden functions in the drive and storing parameters to the customer set. There are numerous options for this parameter, more fully described in Chapter 7, X5 Parameters. Please refer to the detailed description of parameter 801 options in Chapter 7, on page 99.		
810 Language	Default: English	Range: 1-65535 Level 2, Macro
This parameter configures the language in which text strings will be displayed. The following data values may be assigned to this parameter: <u>Parameter Value</u> English Spanish		

6.3 Macro Mode Applications and Included Parameters

The tables below list the different applications and the Level 1 parameters included in the macro for that application. The Factory Application macro is the core package (listed in Table 6-1); the other macros include the Factory Application macro parameters as well as the ones listed in their respective tables (Tables 6-2, 6-3, 6-4, 6-5, and 6-6). The macro mode applications are as follows:

Factory Application (Table 6-1)

Fan Application (Table 6-2)

Fan with PI Application (Table 6-3)

Pump Application (Table 6-4)

Pump with PI Application (Table 6-5)

Vector Application (Table 6-6)

Table 6-1: Factory Application Macro

Para. #	Parameter Name	Default	See Page
001	Model Number	Read-only	71
102	Output Freq	Read-only	72
103	Output Voltage	Read-only	72
104	Output Current	Read-only	72
105	Drive Load	Read-only	72
106	Load Torque	Read-only	72
107	Drive Temp	Read-only	72
111	DC Bus Voltage	Read-only	72
201	Input Mode	Local Only	75
202	Rev Enable	Forward	75
301	Min Frequency	0.0 Hz	79
302	Max Frequency	60.0 Hz	79
303	Preset Freq 1	5.0 Hz	79
402	Accel Time 1	5.0 sec	81
403	Decel Time 1	5.0 sec	81
502	Voltage Boost	0.0%	85
610	Timed OL Select	Std Ind 60s	90
700	Vmet Config	Freq Out	91
705	Relay 1 Select	Drv Fault	93
706	Relay 2 Select	Drive Run	93

Table 6-2: Fan Application Macro (Core Factory Application from Table 6-1, **plus** the following parameters)

Para. #	Parameter Name	Default	See Page
203	Stop Key Remote	Coast	76
204	Ref Select	Vin1	76
205	Vin1 Config	0-10 V	77
206	Vin1 Offset	0.00%	77
207	Vin1 Span	100.00%	77
406	DC Inject Config	DC at Start	82
501	V/Hz Select	Fan Fxd	85
504	Skip Freq Band	0.2 Hz	86
505	Skip Freq 1	0.0 Hz	86
608	Restart Number	0	90
609	Restart Delay	60 sec	90
702	Imet Config	Current Out	92
703	Imet Span	100.0%	92
704	Imet Offset	0.0%	92
721	DI1 Configure	Preset 1	95
722	DI2 Configure	Preset 2	95
723	DI3 Configure	Preset 3	95
724	DI4 Configure	Ref Switch	95
725	DI5 Configure	Fault Reset	95
803	PWM Frequency	16.0 kHz	100
804	Display Mode	Output Freq	100

Table 6-3: Fan with PI Application Macro (Core Factory Application from Table 6-1, **plus** the following parameters)

Para. #	Parameter Name	Default	See Page
203	Stop Key Remote	Coast	76
204	Ref Select	Vin1	76
205	Vin1 Config	0-10 V	77
206	Vin1 Offset	0.00%	77
207	Vin1 Span	100.00%	77
208	Cin Config	0-20 mA 50	77
209	Cin Offset	0.0%	77
210	Cin Span	100.0%	78
211	Vin2 Config	0-10 V	78
212	Vin2 Offset	0.00%	78
213	Vin2 Span	100.00%	78
401	Ramp Select	ART-Strt/RS	81
406	DC Inject Config	DC at Start	82
501	V/Hz Select	Fan Fxd	85
504	Skip Freq Band	0.2 Hz	86
505	Skip Freq 1	0.0 Hz	86
608	Restart Number	0	90
609	Restart Delay	60 sec	90
702	Imet Config	Current Out	92
703	Imet Span	100.0%	92
704	Imet Offset	0.0%	92
721	DI1 Configure	Preset 1	95
722	DI2 Configure	Preset 2	95
723	DI3 Configure	Preset 3	95
724	DI4 Configure	Ref Switch	95
725	DI5 Configure	PI Enable	95
803	PWM Frequency	16.0 kHz	100
804	Display Mode	Output Freq	100
850	PI Configure	No PI	102
851	PI Feedback	Vin1	102
852	PI Prop Gain	0	102
853	PI Int Gain	0	102
854	PI Feed Gain	1000	102
857	PI High Corr	100.00	102
858	PI Low Corr	0.00%	103

Table 6-4: Pump Application Macro (Core Factory Application from Table 6-1, **plus** the following parameters)

Para. #	Parameter Name	Default	See Page
203	Stop Key Remote	Coast	76
204	Ref Select	Vin1	76
205	Vin1 Config	0-10 V	77
206	Vin1 Offset	0.00%	77
207	Vin1 Span	100.00%	77
401	Ramp Select	ART-Strt/RS	81
501	V/Hz Select	Pump Fxd	85
608	Restart Number	0	90
609	Restart Delay	60 sec	90
702	Imet Config	Current Out	92
703	Imet Span	100.0%	92
704	Imet Offset	0.0%	92
721	D11 Configure	Preset 1	95
722	D12 Configure	Preset 2	95
723	D13 Configure	Preset 3	95
724	D14 Configure	Ref Switch	95
725	D15 Configure	Fault Reset	95
803	PWM Frequency	16.0 kHz	100
804	Display Mode	Output Freq	100

Table 6-5: Pump with PI Application Macro (Core Factory Application from Table 6-1, **plus** the following parameters)

Para. #	Parameter Name	Default	See Page
203	Stop Key Remote	Coast	76
204	Ref Select	Vin1	76
205	Vin1 Config	0-10 V	77
206	Vin1 Offset	0.00%	77
207	Vin1 Span	100.00%	77
208	Cin Config	0-20 mA 50	77
209	Cin Offset	0.0%	77
210	Cin Span	100.0%	78
211	Vin2 Config	0-10 V	78
212	Vin2 Offset	0.00%	78
213	Vin2 Span	100.00%	78
401	Ramp Select	ART-Strt/RS	81
406	DC Inject Config	DC at Stop	82
501	V/Hz Select	Pump Fxd	85
504	Skip Freq Band	0.2 Hz	86
505	Skip Freq 1	0.0 Hz	86
608	Restart Number	0	90
609	Restart Delay	60 sec	90
702	Imet Config	Current Out	92
703	Imet Span	100.0%	92
704	Imet Offset	0.0%	92
721	DI1 Configure	Preset 1	95
722	DI2 Configure	Preset 2	95
723	DI3 Configure	Preset 3	95
724	DI4 Configure	Ref Switch	95
725	DI5 Configure	PI Enable	95
803	PWM Frequency	16.0 kHz	100
804	Display Mode	Output Freq	100
850	PI Configure	No PI	102
851	PI Feedback	Vin1	102
852	PI Prop Gain	0	102
853	PI Int Gain	0	102
854	PI Feed Gain	1000	102
857	PI High Corr	100.00	102
858	PI Low Corr	0.00%	103

Table 6-6: Vector Application Macro (Core Factory Application from Table 6-1, *plus the following parameters*)

Para. #	Parameter Name	Default	See Page
501	V/Hz Select	Vector	85
509	Rated Mtr Volt	Model dependent	86
510	Rated Mtr FLA	ND rating	86
511	Rated Mtr RPM	1750 rpm	86
514	Motor RS	Model dependent	86
515	Power Factor	0.8	86
516	Slip Comp Enable	No	87
519	Find Mtr Data	Not Active	87
520	Filter FStator	8 mS	87
521	Start Field En	No	87
522	Filter Time Slip	100 mS	88
523	Id Percent	Read-only	88
524	Iq Percent	Read-only	88
803	PWM Frequency	3.0 kHz	100
804	Display Mode	Std Display	100

6.4 Getting a Quick Start

The following basic procedure is for operators using simple applications who would like to get started quickly. *Be sure to read and understand all the sections in this chapter before proceeding with these instructions.* If you are using remote operators, substitute the speed potentiometer for the INC and DEC (up and down arrow) keys, and the remote Run/Stop switch for the FWD key in the following instructions.

⚠ CAUTION

IMPROPER EQUIPMENT COORDINATION

Verify that proper voltage is connected to the drive before applying power.

Failure to observe this instruction can result in injury or equipment damage.

⚠ ATTENTION

MAUVAISE COORDINATION DES APPAREILS

Vérifiez que l'onduleur est raccordée à la bonne tension avant de le mettre sous tension.

Si cette directive n'est pas respectée, cela peut entraîner des blessures corporelles ou des dommages matériels.

1. Follow all precautions and procedures in “Chapter 3: Receiving and Installation” on page 24.
2. Find the motor nameplate, and using parameters **509 (Rated Mtr Volt)**, **510 (Rated Mtr FLA)**, **511 (Rated Mtr RPM)**, and **515 (Power Factor)**, set up the motor parameters appropriately. Parameter **514 (Motor RS)** should also be set up accurately so the drive can run its routine to measure motor stator resistance. (See “Measuring Stator Resistance (RS Measurement)” on page 51.)
3. Apply AC power to the input terminals. For about 2 seconds the display will show all segments active. The display then changes to zeros.
4. The factory settings are for keypad-only operation in the forward direction—that is, the REV key is disabled. Press the **FWD** key, which causes the FWD indicator to illuminate.
5. Press the **INC** key to increase the desired running frequency. When the display gets to **0.1 Hz**, the drive starts to produce an output.
6. When the motor starts to turn, check the rotation. If the motor is turning in the wrong direction, **press STOP, remove AC power, and wait for all indicators to go out.** After the STATUS indicator has gone out, reverse any two of the motor leads at T1/U, T2/V, or T3/W.
7. The X5 drive is preset to run a typical NEMA B 4-pole induction motor to a maximum speed of **60.0 Hz** with both acceleration and deceleration times set to **5.0 seconds**.
8. Use the **INC** and **DEC** keys to set the proper running speed of the motor and the **FWD** and **STOP** keys to control its operation.

Note that the X5 external cooling fans operate continuously for the first five minutes of power-up time; after this point, they operate only as needed to control the operating temperature of the drive.

Chapter 7: X5 Parameters

7.1 Introduction

The X5 AC drive incorporates a comprehensive set of parameters that allow you to configure the device to meet the special requirements of your particular application.

Note that pressing the PROG key enters Level 1 programming. Press SHIFT+PROG to enter Level 2 programming. Press ENTER+PROG to show only those parameters that have changed from the factory default values.

This chapter describes the available parameters and the values that may be assigned to them. The parameter summary table at the front of this manual provides a summary of all parameters including their ranges and default values.

Note that all parameters can be addressed by adding 40000 to the parameter number. For example, parameter **201** (Input Mode) can be addressed by Modbus address **40201**.

7.2 Level 1 Parameters

The most commonly configured X5 parameters are stored in a group named Level 1. This group is easily accessed by pressing the PROG key as described in “Chapter 5: Operation and Programming” on page 44. The following table lists the parameters in this group; for further information on the parameter, please turn to the indicated page.

Table 7-1: Parameters Available in Level 1 Programming (Factory Macro)

Para. #	Parameter Name	See Page	Para. #	Parameter Name	See Page
001	Model Number	71	303	Preset Freq 1	79
102	Output Freq	72	402	Accel Time 1	81
103	Output Voltage	72	403	Decel Time 1	81
104	Output Current	72	502	Voltage Boost	85
105	Drive Load	72	610	Timed OL Select	90
106	Load Torque	72	700	Vmet Config	91
107	Drive Temp	72	705	Relay 1 Select	93
111	DC Bus Voltage	72	706	Relay 2 Select	93
201	Input Mode	75			
202	Rev Enable	75			
301	Min Frequency	79			
302	Max Frequency	79			

7.3 Description of Parameters

Table 7-2 lists the X5 parameters in the order in which they appear in the keypad display. For each parameter, the table lists the default value and range and also describes the use of the parameter.

Table 7-2: Description of X5 Parameters (Page 1 of 40)

001 Model Number	Read-Only	Range: n/a Level: 1,2
Parameter 001 , the Model Number parameter, contains the portion of the X5 model number related to voltage and horsepower. The number format is <i>vvhhf</i> , where <i>vv</i> is the code for the input voltage (20=230 Vac, three-phase; 40=460 Vac, three-phase; 50=575 Vac, three-phase); <i>hh</i> is horsepower; and <i>f</i> is the fractional part of the horsepower. Example: 20050 = 230 Vac, three-phase, 5.0 HP model.		
002 Software Rev	Read-Only	Range: 0.00-99.99 Level: 2
Parameter 002 , the Software Revision parameter, displays the software revision that is installed in the drive. Options: 0.00-99.99		
003 Rated Current	Read-Only	Range: 0.0-200.0 A Level: 2
Parameter 003 , the Rated Current parameter, displays the normal duty current rating of the model of drive.		
005 Serial No 1	Read-Only	Range: 0-65535 Level: 2
Parameter 005 , Serial No 1 , contains a number that corresponds to the year and week in which the drive was manufactured. The data in this parameter and parameter 006 are combined to make the drive serial number.		
006 Serial No 2	Read-Only	Range: 0-65535 Level: 2
Parameter 006 , Serial No 2 , contains a number that determines the number of the drive that was manufactured during the week of Serial No 1. The data in this parameter and parameter 005 are combined to make the drive serial number.		
007 USB Soft. Rev	Read-Only	Range: n/a Level: 2
Parameter 007 , USB Soft. Rev , shows the revision of the USB software resident in the drive. For more information on using the USB interface, and saving drive parameters and Keeper data to a USB flash memory device, see "Storing Data and Reflashing Using a Flash Memory Device" on page 52 .		
008 Option Installed	Read-Only	Range: n/a Level: 2
This parameter identifies the option installed in the drive. Options are:		
<u>Value</u>	<u>Description</u>	
0	No options installed	
1	X5OPT01	
2	X5DNET01	
3	X5EIP01	
4	X5PROFI01	
5	X5RS48501	
7	X5MBTCP01	
009 Fbus Soft. Rev	Read-Only	Range: n/a Level: 2
This parameter shows the revision level of the Fieldbus software in the option board attached to the drive.		
030 Pwr Down Date	Read-Only	Range: n/a Level: 2
This parameter shows the date of last power-down or reset of the drive, in dd/mm/yy format.		

Table 7-2: Description of X5 Parameters (Page 2 of 40)

031 Pwr Down Time	Read-Only	Range: n/a Level: 2
The day and time of the last power-down or reset of the drive, in Dd/mm/yy format (example: Tu/09/01).		
102 Output Freq	Read-Only	Range: 0.0 to 400.0 Hz Levels 1,2
Parameter 102 , the Output Frequency parameter, shows the frequency being applied to the motor connected to the drive (ramp).		
103 Output Voltage	Read-Only	Range: 0 to 600 V Levels 1,2
Parameter 103 , the Output Voltage parameter, displays the output voltage of the drive.		
104 Output Current	Read-Only	Range: 0.0 to 200.0 A Levels 1,2
Parameter 104 , the Output Current parameter, displays the output current of the drive.		
105 Drive Load	Read-Only	Range: -200.0% to 200.0% Levels 1,2
Parameter 105 , the Drive Load parameter, shows the percentage torque of the drive when operating below the knee frequency. It displays Load Torque if the frequency is below FKNEE, and displays Power if above FKNEE. The output current is measured with the motor power factor applied to an accuracy of $\pm 20\%$. The parameter value is positive when the motor is pulling a load ("motoring mode") and negative when being pulled by a load ("regenerative mode").		
106 Load Torque	Read-Only	Range: -200.0%-200.0% Levels 1,2
Parameter 106 , the Load Torque parameter, displays the load torque of the drive.		
107 Drive Temp	Read-Only	Range: -20.0 to 200.0 °C Levels 1,2
Parameter 107 , the Drive Temp parameter, shows the actual temperature of the drive's heatsink. The drive will fault when the internal temperature reaches 85°C.		
108 Total Run Time	Read-Only	Range: 0.0 - 6553.5 h Level: 2
Parameter 108 , Total Run Time , is a resettable timer for drive operation. To reset the timer, enter 10 in parameter 801 , Program Number .		
109 Power On Hours	Read-only	Range: 0 - 65535 h Level: 2
Parameter 109 , Power On Hours , displays how long the drive has been powered up.		
110 Stator Freq	Read-only	Range: 0.0-400.0 Hz Level: 2
Parameter 110 , Stator Frequency , displays the frequency the drive is applying to the motor stator.		
111 DC Bus Voltage	Read-only	Range: 0-1000 Vdc Level: 1,2
Parameter 111 , DC Bus Voltage , displays the voltage on the DC bus.		
115 Drive Power Out	Read-only	Range: 0.0%-200.0% Level: 2
This parameter displays the power being output by the drive in terms of drive rating. The measurement is calculated by scaling the Load Torque value by the ratio of Volt-Amps to Rated Volt-Amps, and adjusted by Output Frequency.		
116 Out Power (kW)	Read-only	Range: 0.0 - 327.67 kW Level: 2
This parameter displays the average instantaneous power being output by the drive, in kW.		

Table 7-2: Description of X5 Parameters (Page 3 of 40)

117 MWh Meter	Read-only	Range: 0-32767 MWh Level: 2			
This parameter displays megawatt hours of accumulated power consumption.					
118 kWh Meter	Read-only	Range: 0.0-999.9 kWh Level: 2			
This parameter displays kilowatt hours of accumulated power consumption.					
120 Today's Date	Read-Only	Range: MM/dd/YY Level: 2			
This parameter displays today's date for customer access.					
121 Today's Time	Read-Only	Range: 00:00 - 23:59 Level: 2			
This parameter displays today's time for customer access.					
150 Show Clock Param	Default = 0 (No)	Range: n/a Level: 2			
This parameter hides or reveals the Time of Day clock parameters (parameters 152 , 154 , 156 , 158 , 160 , 162). Enabling clock parameters also makes the Keeper parameters visible (see parameters 380 - 389).					
The following data values may be assigned to this parameter:					
<u>Value</u>	<u>Description</u>				
0	No				
1	Yes				
151 Time Zone Setup	Default = 12 (-5 East. US)	Range: n/a Level: 2 (Clock), Macro			
This parameter allows configuration of clocks to account for time zones, in relation to Greenwich Mean Time (GMT).					
The following data values may be assigned to this parameter:					
<u>Value</u>	<u>Description</u>	<u>Value</u>	<u>Description</u>	<u>Value</u>	<u>Description</u>
0	-12 Kwaj.	14	-4 Atlantic	28	+4 Baku
1	-11 Samoa	15	-4 Caracas	29	+5 Islambd
2	-10 Hawaii	16	-3 Brasilia	30	+6 Dhaka
3	-9 Alaska	17	-3 Greenland	31	+7 Bangkok
4	-8 Pac. US	18	-2 Mid Atl	32	+8 Beijing
5	-7 Mountain	19	-1 Azores	33	+9 Tokyo
6	-7 Chih.	20	0 London	34	+10 Sydney
7	-7 Arizona	21	0 Casablanca	35	+10 Vladiv.
8	-6 Cent. US	22	+1 C. Europe	36	+10 Guam
9	-6 Sask.	23	+1 C. Africa	37	+11 Magadan
10	-6 Mexico	24	+2 E. Europe	38	+12 Fiji
11	-6 Cent. Am	25	+2 Cairo	39	+12 N. Zeal.
12	-5 East. US	26	+3 Moscow	40	+13 Tonga
13	-5 Indiana	27	+3 Nairobi		
152 TOD Run Enable	12:00	Range: 00:00 - 23:59 Level: 2 (Clock)			
This parameter sets the starting time that the drive is enabled to run if a Run signal is active. If equal to "Time Run Enable," the function is disabled. (See "Enabling the X5 Based on Time of Day (TOD)" on page 57.)					
154 TOD Run Disable	12:00	Range: 00:00 - 23:59 Level: 2 (Clock)			
This parameter sets the ending time that the drive is enabled to run if a Run signal is active. If equal to "Time Run Disable," the function is disabled. (See "Enabling the X5 Based on Time of Day (TOD)" on page 57.)					
156 TOD Run En 2	12:00	Range: 00:00 - 23:59 Level: 2 (Clock)			

Table 7-2: Description of X5 Parameters (Page 4 of 40)

This parameter sets the starting time that the drive is enabled to run if a Run signal is active. If equal to "Time Run Enable," the function is disabled. (See "Enabling the X5 Based on Time of Day (TOD)" on page 57.)												
158 TOD Run Dis 2	12:00	Range: 00:00 - 23:59 Level: 2 (Clock)										
This parameter sets the ending time that the drive is enabled to run if a Run signal is active. If equal to "Time Run Disable," the function is disabled. (See "Enabling the X5 Based on Time of Day (TOD)" on page 57.)												
160 Weekend TOD Enable	12:00	Range: 00:00 - 23:59 Level: 2 (Clock)										
This parameter sets the starting time that the drive is enabled to run if a Run signal is active. If equal to "Time Run Enable," the function is disabled. (See "Enabling the X5 Based on Time of Day (TOD)" on page 57.)												
162 Weekend TOD Dis	12:00	Range: 00:00 - 23:59 Level: 2 (Clock)										
This parameter sets the ending time that the drive is enabled to run if a Run signal is active. If equal to "Time Run Disable," the function is disabled. (See "Enabling the X5 Based on Time of Day (TOD)" on page 57.)												
171 Reminder 1 Conf.	Default = Disabled	Range: n/a Level: 2										
This parameter configures the reminder to measure the run time or total time before activating the reminder. The following data values may be assigned to this parameter:												
<table border="1"> <thead> <tr> <th>Parameter Value</th> <th>Description</th> </tr> </thead> <tbody> <tr> <td>0</td> <td>Disabled</td> </tr> <tr> <td>1</td> <td>Minute</td> </tr> <tr> <td>2</td> <td>Run Min</td> </tr> <tr> <td>3</td> <td>Gated Min</td> </tr> </tbody> </table>			Parameter Value	Description	0	Disabled	1	Minute	2	Run Min	3	Gated Min
Parameter Value	Description											
0	Disabled											
1	Minute											
2	Run Min											
3	Gated Min											
(See "Reminders" on page 58 for more information on using these parameters.)												
172 Reminder 1 Time	1	Range: 1 - 32000 minutes Level: 2										
Based on parameter 176 (Reminder 2 ETA) , this parameter sets the duration of time in minutes until reminder #1 is set. (See "Reminders" on page 58 for more information on using these parameters.)												
173 Reminder 1 ETA	Read-only	Range: +/- 32000 minutes Level: 2										
This parameter displays the length of time until reminder #1 is set. (See "Reminders" on page 58 for more information on using these parameters.)												
174 Reminder 2 Conf.	Default = Disabled	Range: n/a Level: 2										
This parameter configures the reminder to measure the run time or total time before activating the reminder. The following data values may be assigned to this parameter:												
<table border="1"> <thead> <tr> <th>Parameter Value</th> <th>Description</th> </tr> </thead> <tbody> <tr> <td>0</td> <td>Disabled</td> </tr> <tr> <td>1</td> <td>Hour</td> </tr> <tr> <td>2</td> <td>Run Hour</td> </tr> <tr> <td>3</td> <td>Gated Hour</td> </tr> </tbody> </table>			Parameter Value	Description	0	Disabled	1	Hour	2	Run Hour	3	Gated Hour
Parameter Value	Description											
0	Disabled											
1	Hour											
2	Run Hour											
3	Gated Hour											
(See "Reminders" on page 58 for more information on using these parameters.)												
175 Reminder 2 Time	1	Range: 1 - 32000 hours Level: 2										
Based on parameter 179 (Reminder 3 ETA) , this parameter sets the duration of time in hours until reminder #2 is set. (See "Reminders" on page 58 for more information on using these parameters.)												
176 Reminder 2 ETA	Read-only	Range: +/- 32000 hours Level: 2										

Table 7-2: Description of X5 Parameters (Page 5 of 40)

This parameter displays the length of time until reminder #2 is set. (See "Reminders" on page 58 for more information on using these parameters.)																						
177 Reminder 3 Conf.	Default = Disabled	Range: n/a Level: 2																				
This parameter configures the reminder to measure the run time or total time before activating the reminder. The following data values may be assigned to this parameter:																						
<table border="1"> <thead> <tr> <th><u>Parameter Value</u></th> <th><u>Description</u></th> </tr> </thead> <tbody> <tr> <td>0</td> <td>Disabled</td> </tr> <tr> <td>1</td> <td>Hour</td> </tr> <tr> <td>2</td> <td>Run Hour</td> </tr> <tr> <td>3</td> <td>Gated Hour</td> </tr> </tbody> </table>			<u>Parameter Value</u>	<u>Description</u>	0	Disabled	1	Hour	2	Run Hour	3	Gated Hour										
<u>Parameter Value</u>	<u>Description</u>																					
0	Disabled																					
1	Hour																					
2	Run Hour																					
3	Gated Hour																					
(See "Reminders" on page 58 for more information on using these parameters.)																						
178 Reminder 3 Time	1	Range: 1 - 32000 hours Level: 2																				
Based on parameter 162 (Weekend TOD Dis) , this parameter sets the duration of time in hours until reminder #3 is set. (See "Reminders" on page 58 for more information on using these parameters.)																						
179 Reminder 3 ETA	Read-only	Range: +/- 32000 hours Level: 2																				
This parameter displays the length of time until reminder #3 is set. (See "Reminders" on page 58 for more information on using these parameters.)																						
201 Input Mode	Default = Local only	Range: n/a Levels 1,2																				
Parameter 201 , the Input Mode parameter, configures local and remote control of the Start/Stop source and the reference source. Refer to "Appendix A: Parameter 201 Options" on page 132, for more information.																						
The following data values may be assigned to this parameter:																						
<table border="1"> <thead> <tr> <th><u>Parameter Value</u></th> <th><u>Run/Stop Control</u></th> </tr> </thead> <tbody> <tr> <td>Local only</td> <td>Local keypad operation only</td> </tr> <tr> <td>Remote only</td> <td>Terminal strip operation only</td> </tr> <tr> <td>L/R Rem Ref</td> <td>LOCAl Keypad Start/Stop and Speed REMote Keypad Start/Stop, Terminal Strip Speed Reference</td> </tr> <tr> <td>L/R Rem Ctl</td> <td>LOCAl Keypad Start/Stop and Speed REMote Keypad Speed Reference, Terminal Strip Start/Stop</td> </tr> <tr> <td>L/R Rem Bth</td> <td>LOCAl Keypad Start/Stop and Speed REMote Terminal Strip Start/Stop and Speed Reference</td> </tr> <tr> <td>EMOP^{1} {2} {4}</td> <td>Terminal strip operation using Increase/Decrease buttons</td> </tr> <tr> <td>EMOP2^{1} {3} {4}</td> <td>Terminal strip operation using Increase/Decrease buttons</td> </tr> <tr> <td>LOC/EMOP^{1} {2} {4}</td> <td>LOCAl Keypad Start/Stop and Speed REMote Terminal strip operation using Increase/Decrease</td> </tr> <tr> <td>LOC/EMOP2^{1} {3} {4}</td> <td>LOCAl Keypad Start/Stop and Speed REMote Terminal strip operation using Increase/Decrease</td> </tr> </tbody> </table>			<u>Parameter Value</u>	<u>Run/Stop Control</u>	Local only	Local keypad operation only	Remote only	Terminal strip operation only	L/R Rem Ref	LOCAl Keypad Start/Stop and Speed REMote Keypad Start/Stop, Terminal Strip Speed Reference	L/R Rem Ctl	LOCAl Keypad Start/Stop and Speed REMote Keypad Speed Reference, Terminal Strip Start/Stop	L/R Rem Bth	LOCAl Keypad Start/Stop and Speed REMote Terminal Strip Start/Stop and Speed Reference	EMOP ^{1} {2} {4}	Terminal strip operation using Increase/Decrease buttons	EMOP2 ^{1} {3} {4}	Terminal strip operation using Increase/Decrease buttons	LOC/EMOP ^{1} {2} {4}	LOCAl Keypad Start/Stop and Speed REMote Terminal strip operation using Increase/Decrease	LOC/EMOP2 ^{1} {3} {4}	LOCAl Keypad Start/Stop and Speed REMote Terminal strip operation using Increase/Decrease
<u>Parameter Value</u>	<u>Run/Stop Control</u>																					
Local only	Local keypad operation only																					
Remote only	Terminal strip operation only																					
L/R Rem Ref	LOCAl Keypad Start/Stop and Speed REMote Keypad Start/Stop, Terminal Strip Speed Reference																					
L/R Rem Ctl	LOCAl Keypad Start/Stop and Speed REMote Keypad Speed Reference, Terminal Strip Start/Stop																					
L/R Rem Bth	LOCAl Keypad Start/Stop and Speed REMote Terminal Strip Start/Stop and Speed Reference																					
EMOP ^{1} {2} {4}	Terminal strip operation using Increase/Decrease buttons																					
EMOP2 ^{1} {3} {4}	Terminal strip operation using Increase/Decrease buttons																					
LOC/EMOP ^{1} {2} {4}	LOCAl Keypad Start/Stop and Speed REMote Terminal strip operation using Increase/Decrease																					
LOC/EMOP2 ^{1} {3} {4}	LOCAl Keypad Start/Stop and Speed REMote Terminal strip operation using Increase/Decrease																					
Notes:																						
1. Electronic Motor Operated Potentiometer (EMOP): simulates the INC/DEC (up/down arrow) keys on a keypad that uses external remote N/O pushbuttons																						
2. Commanded output frequency returns to the value of parameter 301 (Min Frequency) when the drive is stopped.																						
3. Commanded output frequency remains at the previous setpoint when the drive is stopped.																						
4. The parameters that set the functions of the designated digital inputs for EMOP must be configured as "EMOP+" and "EMOP-" to complete the implementation.																						
202 Rev Enable	Default = Forward	Range: n/a Levels 1,2																				

Table 7-2: Description of X5 Parameters (Page 6 of 40)

<p>Parameter 202, the Rev Enable parameter, configures whether the REV key on the keypad is functional. If this parameter is configured to "Forward," then pressing the REV key on the keypad will have no effect. Note that this parameter does not affect terminal strip operation.</p> <p>The following data values may be assigned to this parameter:</p> <table border="1"> <thead> <tr> <th>Parameter Value</th> <th>Description</th> </tr> </thead> <tbody> <tr> <td>Forward</td> <td>Forward Only, REV key disabled</td> </tr> <tr> <td>FWD/REV</td> <td>FWD and REV keys enabled</td> </tr> </tbody> </table>			Parameter Value	Description	Forward	Forward Only, REV key disabled	FWD/REV	FWD and REV keys enabled																								
Parameter Value	Description																															
Forward	Forward Only, REV key disabled																															
FWD/REV	FWD and REV keys enabled																															
203 Stop Key Remote	Default = Coast	Range: n/a Level: 2																														
<p>Parameter 203, the Stop Key Remote parameter, configures how the Stop key on the keypad will operate when the keypad is not the drive's control source (terminals, SIO, or SEQ).</p> <p>The following data values may be assigned to this parameter:</p> <table border="1"> <thead> <tr> <th>Parameter Value</th> <th>Description</th> </tr> </thead> <tbody> <tr> <td>Coast</td> <td>Drive will coast to a stop</td> </tr> <tr> <td>Ramp</td> <td>Drive will ramp to a stop using Decel #1</td> </tr> <tr> <td>Disabled</td> <td>Stop key will have no function</td> </tr> </tbody> </table>			Parameter Value	Description	Coast	Drive will coast to a stop	Ramp	Drive will ramp to a stop using Decel #1	Disabled	Stop key will have no function																						
Parameter Value	Description																															
Coast	Drive will coast to a stop																															
Ramp	Drive will ramp to a stop using Decel #1																															
Disabled	Stop key will have no function																															
204 Ref Select	Default = Vin1	Range: n/a Level: 2																														
<p>Parameter 204, the Ref Select parameter, configures how the reference is determined when the reference source is configured to terminals.</p> <p>The following data values may be assigned to this parameter:</p> <table border="1"> <thead> <tr> <th>Parameter Value</th> <th>Description</th> </tr> </thead> <tbody> <tr> <td>Vin1</td> <td>Vin1 terminal (configured by parameter 205)</td> </tr> <tr> <td>Cin</td> <td>Cin terminal (configured by parameter 208)</td> </tr> <tr> <td>Vin2</td> <td>Vin2 terminal (configured by parameter 211)</td> </tr> <tr> <td>Vin1 6FS</td> <td>Vin1 terminal with 6x pulse train from an X5, WFC, WF2 drive</td> </tr> <tr> <td>Vin1 48FS</td> <td>Vin1 terminal with 48x pulse train from an X5, WFC, WF2 drive</td> </tr> <tr> <td>Vin1+Cin</td> <td>Sum of signal at Vin1 and the signal at Cin</td> </tr> <tr> <td>Vin1+Vin2</td> <td>Sum of signal at Vin1 and the signal at Vin2</td> </tr> <tr> <td>Vin1-Cin</td> <td>Difference between the signal at Vin and the signal at Cin</td> </tr> <tr> <td>Vin1-Vin2</td> <td>Difference between the signal at Vin and the signal at Vin2</td> </tr> <tr> <td>Max Input⁽²⁾</td> <td>Greatest signal between Vin, Vin2 and Cin</td> </tr> <tr> <td>Vin1/Cin DI⁽¹⁾</td> <td>Switch between Vin and Cin using a Digital Input</td> </tr> <tr> <td>Vin1/2 DI⁽¹⁾</td> <td>Switch between Vin and Vin2 using a Digital Input</td> </tr> <tr> <td>Vin1/KYP DI⁽¹⁾</td> <td>Switch between Vin and Keypad reference using Digital Input</td> </tr> <tr> <td>Cin/KYP DI⁽¹⁾</td> <td>Switch between Cin and Keypad reference using Digital Input</td> </tr> </tbody> </table>			Parameter Value	Description	Vin1	Vin1 terminal (configured by parameter 205)	Cin	Cin terminal (configured by parameter 208)	Vin2	Vin2 terminal (configured by parameter 211)	Vin1 6FS	Vin1 terminal with 6x pulse train from an X5, WFC, WF2 drive	Vin1 48FS	Vin1 terminal with 48x pulse train from an X5, WFC, WF2 drive	Vin1+Cin	Sum of signal at Vin1 and the signal at Cin	Vin1+Vin2	Sum of signal at Vin1 and the signal at Vin2	Vin1-Cin	Difference between the signal at Vin and the signal at Cin	Vin1-Vin2	Difference between the signal at Vin and the signal at Vin2	Max Input ⁽²⁾	Greatest signal between Vin, Vin2 and Cin	Vin1/Cin DI ⁽¹⁾	Switch between Vin and Cin using a Digital Input	Vin1/2 DI ⁽¹⁾	Switch between Vin and Vin2 using a Digital Input	Vin1/KYP DI ⁽¹⁾	Switch between Vin and Keypad reference using Digital Input	Cin/KYP DI ⁽¹⁾	Switch between Cin and Keypad reference using Digital Input
Parameter Value	Description																															
Vin1	Vin1 terminal (configured by parameter 205)																															
Cin	Cin terminal (configured by parameter 208)																															
Vin2	Vin2 terminal (configured by parameter 211)																															
Vin1 6FS	Vin1 terminal with 6x pulse train from an X5, WFC, WF2 drive																															
Vin1 48FS	Vin1 terminal with 48x pulse train from an X5, WFC, WF2 drive																															
Vin1+Cin	Sum of signal at Vin1 and the signal at Cin																															
Vin1+Vin2	Sum of signal at Vin1 and the signal at Vin2																															
Vin1-Cin	Difference between the signal at Vin and the signal at Cin																															
Vin1-Vin2	Difference between the signal at Vin and the signal at Vin2																															
Max Input ⁽²⁾	Greatest signal between Vin, Vin2 and Cin																															
Vin1/Cin DI ⁽¹⁾	Switch between Vin and Cin using a Digital Input																															
Vin1/2 DI ⁽¹⁾	Switch between Vin and Vin2 using a Digital Input																															
Vin1/KYP DI ⁽¹⁾	Switch between Vin and Keypad reference using Digital Input																															
Cin/KYP DI ⁽¹⁾	Switch between Cin and Keypad reference using Digital Input																															
<p>Notes:</p> <ol style="list-style-type: none"> 1. The parameter that sets the function of the designated digital input must be configured as "Ref Switch" to complete the implementation. 2. The "Max Input" option will compare the inputs of all three analog inputs (Vin1, Vin2, Cin) and take the analog input with the highest percentage input after span, offset, and inversion is applied. 																																

Table 7-2: Description of X5 Parameters (Page 7 of 40)

205 Vin1 Config	Default = 0-10V	Range: n/a Level: 2																												
<p>Parameter 205, Vin1 Config, selects the type of signal for analog input Vin1. Vin1 can be voltage, current, or pulse train input. This parameter also determines input range, impedance, and characteristics. Use Parameters 206 (Vin1 Offset) and 207 (Vin1 Span) to customize the selected range. The following data values may be assigned to this parameter:</p> <table border="1"> <thead> <tr> <th>Parameter Value</th> <th>Description</th> </tr> </thead> <tbody> <tr> <td>0-10V</td> <td>0-10Vdc signal. This is the selection that is recommended when the drive is following the 6FS or 48FS output of another drive.</td> </tr> <tr> <td>0-10V Brk W</td> <td>0-10Vdc signal with broken wire detection for speed pot operation</td> </tr> <tr> <td>0-10V I</td> <td>0-10Vdc signal Inverted</td> </tr> <tr> <td>0-10V Bipol</td> <td>0-10Vdc signal (5Vdc is stop with 0Vdc Full Rev and 10Vdc Full FWD)</td> </tr> <tr> <td>0-5V</td> <td>0-5Vdc signal</td> </tr> <tr> <td>0-5V I</td> <td>0-5Vdc signal Inverted</td> </tr> <tr> <td>0-20mA 250</td> <td>0 to 20 mA current signal with 250 Ohm load</td> </tr> <tr> <td>0-20mA 250I</td> <td>0 to 20 mA current signal with 250 Ohm load Inverted</td> </tr> <tr> <td>4-20mA 250</td> <td>4 to 20 mA current signal with 250 Ohm load load</td> </tr> <tr> <td>4-20mA 250I</td> <td>4 to 20 mA current signal with 250 Ohm load Inverted</td> </tr> <tr> <td>PT 0-1kHz</td> <td>0 to 1 kHz pulse train</td> </tr> <tr> <td>PT 0-10kHz</td> <td>0 to 10 kHz pulse train</td> </tr> <tr> <td>PT 0-100kHz</td> <td>0 to 100 kHz pulse train</td> </tr> </tbody> </table> <p>Inverted signal response means that minimum input signal produces maximum inverter output frequency and maximum input signal produces minimum output frequency.</p>			Parameter Value	Description	0-10V	0-10Vdc signal. This is the selection that is recommended when the drive is following the 6FS or 48FS output of another drive.	0-10V Brk W	0-10Vdc signal with broken wire detection for speed pot operation	0-10V I	0-10Vdc signal Inverted	0-10V Bipol	0-10Vdc signal (5Vdc is stop with 0Vdc Full Rev and 10Vdc Full FWD)	0-5V	0-5Vdc signal	0-5V I	0-5Vdc signal Inverted	0-20mA 250	0 to 20 mA current signal with 250 Ohm load	0-20mA 250I	0 to 20 mA current signal with 250 Ohm load Inverted	4-20mA 250	4 to 20 mA current signal with 250 Ohm load load	4-20mA 250I	4 to 20 mA current signal with 250 Ohm load Inverted	PT 0-1kHz	0 to 1 kHz pulse train	PT 0-10kHz	0 to 10 kHz pulse train	PT 0-100kHz	0 to 100 kHz pulse train
Parameter Value	Description																													
0-10V	0-10Vdc signal. This is the selection that is recommended when the drive is following the 6FS or 48FS output of another drive.																													
0-10V Brk W	0-10Vdc signal with broken wire detection for speed pot operation																													
0-10V I	0-10Vdc signal Inverted																													
0-10V Bipol	0-10Vdc signal (5Vdc is stop with 0Vdc Full Rev and 10Vdc Full FWD)																													
0-5V	0-5Vdc signal																													
0-5V I	0-5Vdc signal Inverted																													
0-20mA 250	0 to 20 mA current signal with 250 Ohm load																													
0-20mA 250I	0 to 20 mA current signal with 250 Ohm load Inverted																													
4-20mA 250	4 to 20 mA current signal with 250 Ohm load load																													
4-20mA 250I	4 to 20 mA current signal with 250 Ohm load Inverted																													
PT 0-1kHz	0 to 1 kHz pulse train																													
PT 0-10kHz	0 to 10 kHz pulse train																													
PT 0-100kHz	0 to 100 kHz pulse train																													
206 Vin1 Offset	Default = 0.00%	Range: 0.0 to 100.0% Level: 2																												
<p>Parameter 206, Vin1 Offset, configures the input range (offset) for analog input Vin1 that will affect speed or torque limit functions. It is expressed as a percentage of the maximum value of the input signal.</p> <p>Note that if the input signal drops below the offset value or if the input signal is lost (if no offset is configured), fault 22 will be generated.</p>																														
207 Vin1 Span	Default = 100%	Range: 10.0 to 200.0% Level: 2																												
<p>Parameter 207, the Vin1 Span parameter, is used to alter the input range (span) of the input signal for analog input Vin1 that will affect speed or torque limit functions. For example, if parameter 205, Vin1 Config, selects the 0 to 10 Vdc input signal, setting this parameter to 50% reduces it to 0 to 5 Vdc.</p>																														
208 Cin Config	Default = 0-20mA 50	Range: n/a Level 2																												
<p>Parameter 208, Cin Config, selects the type of signal for analog input Cin. Parameters 209 (Cin Offset) and 210 (Cin Span) may be used to customize the selected range. The following data values may be assigned to this parameter:</p> <table border="1"> <thead> <tr> <th>Parameter Value</th> <th>Description</th> </tr> </thead> <tbody> <tr> <td>4-20mA 50</td> <td>4 to 20 mA current signal with 50 Ohm load</td> </tr> <tr> <td>4-20mA 50I</td> <td>4 to 20 mA current signal with 50 Ohm load Inverted</td> </tr> <tr> <td>0-20mA 50</td> <td>0 to 20 mA current signal with 50 Ohm load</td> </tr> <tr> <td>0-20mA 50I</td> <td>0 to 20 mA current signal with 50 Ohm load Inverted</td> </tr> </tbody> </table> <p>Inverted signal response means that minimum input signal produces maximum inverter output frequency and maximum input signal produces minimum output frequency.</p>			Parameter Value	Description	4-20mA 50	4 to 20 mA current signal with 50 Ohm load	4-20mA 50I	4 to 20 mA current signal with 50 Ohm load Inverted	0-20mA 50	0 to 20 mA current signal with 50 Ohm load	0-20mA 50I	0 to 20 mA current signal with 50 Ohm load Inverted																		
Parameter Value	Description																													
4-20mA 50	4 to 20 mA current signal with 50 Ohm load																													
4-20mA 50I	4 to 20 mA current signal with 50 Ohm load Inverted																													
0-20mA 50	0 to 20 mA current signal with 50 Ohm load																													
0-20mA 50I	0 to 20 mA current signal with 50 Ohm load Inverted																													
209 Cin Offset	Default = 0.0%	Range: 0.0% to 100.0% Level: 2																												
<p>Parameter 209, Cin Offset, configures the offset for analog input Cin expressed as a percentage of the maximum value of the input signal. See parameter 222 for options related to the drive's response to loss of input signal.</p>																														

Table 7-2: Description of X5 Parameters (Page 8 of 40)

210 Cin Span	Default = 100.0%	Range: 10.0% to 200.0%														
Parameter 210, Cin Span , is used to alter the range of the input signal for analog input Cin. For example, if parameter 208 (Cin Config) selects the 0 to 20 mA input signal, setting this parameter to 50% reduces it to 0 to 10 mA.																
211 Vin2 Config	Default = 0-10 V	Range: n/a Level: 2														
Parameter 211, Vin2 Config , selects the type of signal for analog input Vin2. Parameters 212 (Vin2 Offset) and 213 (Vin2 Span) may be used to customize the selected range. The following data values may be assigned to this parameter:																
<table border="1"> <thead> <tr> <th>Parameter Value</th> <th>Description</th> </tr> </thead> <tbody> <tr> <td>0-10V</td> <td>0-10Vdc signal</td> </tr> <tr> <td>0-10V Brk W</td> <td>0-10Vdc signal with broken wire detection for speed pot operation</td> </tr> <tr> <td>0-10V I</td> <td>0-10Vdc signal inverted</td> </tr> <tr> <td>0-10V Bipol</td> <td>0-10Vdc signal (5Vdc is stop with 0Vdc Full REV and 10Vdc Full FWD)</td> </tr> <tr> <td>0-5V</td> <td>0-5Vdc signal</td> </tr> <tr> <td>0-5V I</td> <td>0-5Vdc signal inverted</td> </tr> </tbody> </table>			Parameter Value	Description	0-10V	0-10Vdc signal	0-10V Brk W	0-10Vdc signal with broken wire detection for speed pot operation	0-10V I	0-10Vdc signal inverted	0-10V Bipol	0-10Vdc signal (5Vdc is stop with 0Vdc Full REV and 10Vdc Full FWD)	0-5V	0-5Vdc signal	0-5V I	0-5Vdc signal inverted
Parameter Value	Description															
0-10V	0-10Vdc signal															
0-10V Brk W	0-10Vdc signal with broken wire detection for speed pot operation															
0-10V I	0-10Vdc signal inverted															
0-10V Bipol	0-10Vdc signal (5Vdc is stop with 0Vdc Full REV and 10Vdc Full FWD)															
0-5V	0-5Vdc signal															
0-5V I	0-5Vdc signal inverted															
212 Vin2 Offset	Default = 0.0%	Range: 0.0% to 100.0% Level: 2														
Parameter 212, Vin2 Offset , configures the offset for analog input Vin2 expressed as a percentage of the maximum value of the input signal. See parameter 222 for options related to the drive's response to loss of input signal.																
213 Vin2 Span	Default = 100%	Range: 10.0 to 200.0%														
Parameter 213, Vin2 Span , is used to alter the range of the input signal for analog input Vin2. For example, if parameter 211 (Vin2 Config) selects the 0 to 10Vdc input signal, setting this parameter to 50% reduces it to 0 to 5Vdc.																
214 Vin1 Filter Time	Default = 20 ms	Range: 0 to 1000 ms Level: 2														
This parameter configures the time constant of a filter for the Vin1 analog input. When the parameter value is set to 0 ms, there is no software filtering of the analog input. A value above 0 ms causes the drive to filter the analog signal. Note that long filter times will create a delay in the drive response to signal changes.																
215 Cin Filter Time	Default = 20 ms	Range: 0 to 1000 ms Level: 2														
This parameter configures the time constant of a filter of the Cin analog input. When the parameter value is set to 0 ms, there is no software filtering of the analog input. A value above 0 ms causes the drive to filter the analog signal. Note that long filter times will create a delay in the drive response to signal changes.																
216 Vin2 Filter Time	Default = 20 ms	Range: 0 to 1000 ms Level: 2														
This parameter configures the time constant of a filter for the Vin2 analog input. When the parameter value is set to 0 ms, there is no software filtering of the analog input. A value above 0 ms causes the drive to filter the analog signal. Note that long filter times will create a delay in the drive response to signal changes.																
217 Trim Ref Enable	Default = Disabled	Range: n/a Level: 2														
This parameter enables or disables trimming of the drive reference by an analog input and selects which analog input will perform the trimming function.																
Speed Reference = Main reference + (Trim % Factor) * (Analog in Percentage) * Max Frequency / 100%																
<table border="1"> <thead> <tr> <th>Parameter Value</th> <th>Description</th> </tr> </thead> <tbody> <tr> <td>Disabled</td> <td>No trimming of drive reference</td> </tr> <tr> <td>Vin1</td> <td>Value of Vin1 will be used in the calculation above</td> </tr> <tr> <td>Vin2</td> <td>Value of Vin2 will be used in the calculation above</td> </tr> <tr> <td>Cin</td> <td>Value of Cin will be used in the calculation above</td> </tr> <tr> <td>Fxd Trim %</td> <td>Value of Fxd Trim % will be used</td> </tr> </tbody> </table>			Parameter Value	Description	Disabled	No trimming of drive reference	Vin1	Value of Vin1 will be used in the calculation above	Vin2	Value of Vin2 will be used in the calculation above	Cin	Value of Cin will be used in the calculation above	Fxd Trim %	Value of Fxd Trim % will be used		
Parameter Value	Description															
Disabled	No trimming of drive reference															
Vin1	Value of Vin1 will be used in the calculation above															
Vin2	Value of Vin2 will be used in the calculation above															
Cin	Value of Cin will be used in the calculation above															
Fxd Trim %	Value of Fxd Trim % will be used															
Drive Reference = Drive Reference + (Trim % Factor) * Max Frequency / 100% / 100%																
Note that setting a parameter for a Bipolar input value allows trimming both positive and negative around the reference value.																

Table 7-2: Description of X5 Parameters (Page 9 of 40)

218 Trim % Factor	Default = 0.0%	Range: -100.0% to +100.0% Level 2
This parameter determines the percentage of the analog input signal selected in Parameter 217, Trim Ref Enable , that will affect the reference signal.		
222 Ref Loss Config	Default = No Fault	Range: n/a Level 2
This parameter allows for the control of the drive's response to a 4-20mA input on either the Vin1 or Cin input terminals when the input drops below approximately 3mA. The default value is No Fault. The options for this parameter are: Retain Spd Hold the last operating speed Preset Spd2 Go to the speed programmed at address 304 Fault Drive faults with an F22 Reference Loss indication No Fault Drive does NOT fault; operating frequency drops to the limit set at Parameter 301, Min Frequency		
301 Min Frequency	Default = 0.0%	Range: 0.0-Max Freq
Parameter 301, Minimum Frequency , configures the minimum frequency output of the drive. This parameter governs the minimum frequency when operating from the keypad or from an analog input. The preset speeds can be set lower than the minimum frequency in parameter 301 .		
302 Max Frequency	Default: 60 Hz	Range: 0.0 to 400.0 Hz
Parameter 302 , the Maximum Frequency parameter, configures the maximum frequency output of the drive.		
303 Preset Freq 1 (Jog Ref) 304 Preset Freq 2 305 Preset Freq 3 306 Preset Freq 4 307 Preset Freq 5 308 Preset Freq 6 310 Preset Freq 7 311 Preset Freq 8 312 Preset Freq 9 313 Preset Freq 10 314 Preset Freq 11 315 Preset Freq 12 316 Preset Freq 13 317 Preset Freq 14 318 Preset Freq 15	Default: 5 Hz Default: 10 Hz Default: 20 Hz Default: 30 Hz Default: 40 Hz Default: 50 Hz Default: 60 Hz Default: 0 Hz Default: 2.5 Hz Default: 7.5 Hz Default: 15 Hz Default: 25 Hz Default: 35 Hz Default: 45 Hz Default: 55 Hz	Range: 0.0-Max Freq Levels 1,2 for 303 Level 2 for 304-318
These parameters configure fifteen preset speeds in addition to the normal reference speed of the drive (as defined by parameters 201 (Input Mode) and 204 (Ref Select) and the maximum frequency of the drive (as set with parameter 302, Max Frequency). Thus, in effect, you may choose to operate the drive at up to 16 different speeds. The speeds are selected by a combination of four digital inputs (PS1, PS2, PS3, PS4). A wiring scheme for utilizing preset speeds is provided on page 41 along with a chart showing what combination of inputs results in the selection of which speeds. Note that parameter Parameter 303 (Preset Freq1) also serves as the reference frequency for jogging.		
309 Cut-Off Freq	Default: 0.0 Hz	Range: 0.0 to 5.0 Hz Level 2
This parameter sets the point where the drive no longer attempts to spin the motor. The range of this parameter is 0.0-5.0 Hz. When the parameter is configured to a value of 0.0 Hz, the drive will operate with no Cut-off Frequency. If the function is enabled, the drive will be able to ramp up through the cut-off frequency range, as in normal operation. If the speed command falls below the cut-off frequency, the drive stops "gating" the outputs and coasts down to zero speed. The keypad display will indicate Zero Speed, and the Forward or Reverse LED will be lit depending on the command. When the reference returns to a value greater than the cut-off frequency, the drive will ramp from 0.0 Hz to the reference frequency.		
380 Keeper Input Cfg	Default: Disabled	Range: n/a Level 2 (Clock)

Table 7-2: Description of X5 Parameters (Page 10 of 40)

<p>This parameter allows you to enable and configure a data logger feature called the “Keeper.” The Keeper parameters (380 through 389) are hidden until you enable the Clock parameters (select Yes for parameter 150, Show Clock Parameters). The following parameter values determine the input for the Keeper:</p> <table border="1"> <thead> <tr> <th>Parameter Value</th> <th>Description</th> </tr> </thead> <tbody> <tr> <td>0</td> <td>Disabled</td> </tr> <tr> <td>1</td> <td>Vin1</td> </tr> <tr> <td>2</td> <td>Cin</td> </tr> <tr> <td>3</td> <td>Vin2</td> </tr> <tr> <td>4</td> <td>Encoder</td> </tr> </tbody> </table> <p>For detailed information about setting up Keeper parameters, see “Using the Keeper Data Log” on page 55.</p>			Parameter Value	Description	0	Disabled	1	Vin1	2	Cin	3	Vin2	4	Encoder
Parameter Value	Description													
0	Disabled													
1	Vin1													
2	Cin													
3	Vin2													
4	Encoder													
381 Keeper Max Scale	Default: 1000	Range: 1 - 32000 (units dependent on parameter 389) Level 2 (Clock)												
<p>This parameter configures the value of the Keeper input signal when the analog input is at its maximum value. For detailed information about setting up Keeper parameters, see “Using the Keeper Data Log” on page 55.</p>														
382 Keeper Save Time	Default: 0:00	Range: 00:00 - 23:59 Level 2 (Clock)												
<p>This parameter sets the time of each day when the Keeper will save an accumulated process variable. For detailed information about setting up Keeper parameters, see “Using the Keeper Data Log” on page 55.</p>														
384 Keeper Save Rate	Default: 24 hour	Range: n/a Level 2 (Clock)												
<p>This parameter configures whether the Keeper will collect multiple records during a day, with these options:</p> <table border="1"> <thead> <tr> <th>Parameter Value</th> <th>Description</th> </tr> </thead> <tbody> <tr> <td>0</td> <td>24 Hour</td> </tr> <tr> <td>1</td> <td>12 Hour</td> </tr> <tr> <td>2</td> <td>8 Hour</td> </tr> </tbody> </table> <p>For detailed information about setting up Keeper parameters, see “Using the Keeper Data Log” on page 55.</p>			Parameter Value	Description	0	24 Hour	1	12 Hour	2	8 Hour				
Parameter Value	Description													
0	24 Hour													
1	12 Hour													
2	8 Hour													
385 Keeper Input Value	Default: Read-only	Range: 0 - 32000 Levels 2 (Clock)												
<p>This parameter provides feedback to display the current value of the Keeper input. For detailed information about setting up Keeper parameters, see “Using the Keeper Data Log” on page 55.</p>														
386 Keeper Time Rate	Default: 1 (Minute)	Range: n/a Level 2 (Clock)												
<p>This parameter configures the time base of the Keeper accumulation. The setting of this variable is dependent on the process variable. The following parameter values are valid:</p> <table border="1"> <thead> <tr> <th>Parameter Value</th> <th>Description</th> </tr> </thead> <tbody> <tr> <td>0</td> <td>Second</td> </tr> <tr> <td>1</td> <td>Minute</td> </tr> <tr> <td>2</td> <td>Hour</td> </tr> </tbody> </table> <p>For detailed information about setting up Keeper parameters, see “Using the Keeper Data Log” on page 55.</p>			Parameter Value	Description	0	Second	1	Minute	2	Hour				
Parameter Value	Description													
0	Second													
1	Minute													
2	Hour													
387 Keeper Rec. Num	Default: Read-only	Range: 0 - 128 Levels 2 (Clock)												
<p>This parameter shows how many records have been saved by the Keeper. For detailed information about setting up Keeper parameters, see “Using the Keeper Data Log” on page 55.</p>														
388 Active Kpr. Record	Default: Read-only	Range: 0 - 128 Levels 2 (Clock)												
<p>This parameter shows the active Keeper record. For detailed information about setting up Keeper parameters, see “Using the Keeper Data Log” on page 55.</p>														

Table 7-2: Description of X5 Parameters (Page 11 of 40)

389 Keeper Units	Default: 1 (GPM)	Range: n/a Levels 2 (Clock)
This parameter defines what units will be used for Keeper input data. The following values can be used:		
<u>Parameter Value</u>	<u>Description</u>	
0	User units	
1	GPM	
2	LPM	
3	LPM	
4	FPM	
5	MPM	
For detailed information about setting up Keeper parameters, see "Using the Keeper Data Log" on page 55.		
401 Ramp Select	Default: ART DI	Range: n/a Level: 2
The Ramp Select parameter configures when the alternate ramps of the drive will be active and whether the drive ramps to stop, or coasts to stop. The following data values may be assigned to this parameter:		
<u>Parameter Value</u>	<u>Type of Ramp</u>	<u>Ramp Configured by:</u>
ART-DI	Ramp-to-Stop	402 (Accel Time 1) and 403 (Decel Time 1) ; 404 (Accel Time 2) and 405 (Decel Time 2) ; 415 (Accel Time 3) and 416 (Decel Time 3) ; 417 (Accel Time 4) and 418 (Decel Time 4) . These are all based on digital inputs configured in AltRamp and AltRamp2 (see parameter 727, MOL Configure). See also the note on page 96 about AltRamp and AltRamp2 .
ART-F/R	Ramp-to-Stop	Running forward: 402 (Accel Time 1) and 403 (Decel Time 1) Running reverse: 404 (Accel Time 2) and 405 (Decel Time 2)
ART-Frq	Ramp-to-Stop	If the output frequency is less than preset frequency parameter 308 (Preset Freq 6) , the active ramp is set by 402 Accel Time 1 and 403 Decel Time 1 . If the output frequency is equal to or greater than 308 (Preset Freq 6) , the active ramp is set by 404 (Accel Time 2) and 405 (Decel Time 2) .
ART-Strt/RS	Ramp-to-Stop	This setting uses the Alternate Ramp for Acceleration (parameter 404) to the set speed, then uses the Main ramps (parameters 402 and 403) when the speeds are adjusted. The drive will revert to the Alternate Decel ramp (parameter 405) when a Stop command is given.
S-Curve	Ramp-to-Stop	The drive uses 402 (Accel Time 1) and 403 (Decel Time 1) for total time and 414 as the S Ramp Rounding value. The amount of rounding is the same for that start and stop of the ramp time.
ART-DI CTS	Coast-to-Stop	Same as ART-DI but with Coast-to-Stop
ART-F/R CTS	Coast-to-Stop	Same as ART-F/R but with Coast-to-Stop
ART-Frq CTS	Coast-to-Stop	Same as ART-Frq but with Coast-to-Stop
ART-Str/CS	Coast-to-Stop	Same as ART-Strt but with Coast-to-Stop
S-Curve CTS	Coast-to-Stop	Same as S-Curve but with Coast-to-Stop
402 Accel Time 1	Default: 5.0 s	Range: 0.1 to 3200.0 s Levels 1,2
This parameter configures the default length of time to accelerate from 0 Hz to the value of parameter 302 (Max Frequency) . This acceleration ramp is selected by parameter 401 (Ramp Select) .		
Note that extremely short acceleration times may result in nuisance fault trips.		
403 Decel Time 1	Default: 5.0 s	Range: 0.1 to 3200.0 s Levels 1,2
This parameter configures the default length of time to decelerate from the value of parameter 302 (Max Frequency) to 0 Hz. The deceleration ramp is selected by parameter 401 (Ramp Select) .		
Note that extremely short deceleration times may result in nuisance fault trips or may require an external dynamic brake or regen current limit.		

Table 7-2: Description of X5 Parameters (Page 12 of 40)

404 Accel Time 2	Default: 3.0 s	Range: 0.1 to 3200.0 s Level 2										
<p>This parameter provides an alternate ramping time for the drive when accelerating, configuring the length of time to accelerate from 0 Hz to the value of parameter 302 (Max Frequency). This acceleration ramp is selected by parameter 401 (Ramp Select) or Sequencer Configuration.</p> <p>Note that extremely short acceleration times may result in nuisance fault trips.</p>												
405 Decel Time 2	Default: 3.0 s	Range: 0.1 to 3200.0 s Level 2										
<p>This parameter provides an alternate ramping time for the drive when decelerating, configuring the length of time to decelerate from the value of parameter 302 (Max Frequency) to 0 Hz. This deceleration ramp is selected by parameter 401 (Ramp Select) or Sequencer Configuration.</p> <p>Note that extremely short deceleration times may result in nuisance fault trips or may require an external dynamic brake or regen current limit.</p>												
406 DC Inject Config	Default: DC at Stop	Range: n/a Level 2										
<p>DC injection braking may be used to stop the motor more quickly than is possible by either a ramp-to-stop or a coast-to-stop. The X5 drive allows DC braking to be initiated either when a digital input assigned to DC braking becomes true, when a specified frequency is reached, or when either of these events occurs.</p> <p>When using a digital input for DC braking, you must use one of the DI parameters to configure the selected digital input for DC braking. The amount of braking force is set by parameter 408 (DC Inject Level). The length of time that the braking force is applied is determined by the time that the selected digital input is active. The second type of DC injection braking supported by the X5 drive is where DC braking occurs at a specified frequency. The duration of the braking is adjusted by parameter 407 (DC Inject Time).</p> <p>With this type of braking, as the drive slows down after a Stop command, DC braking begins when the frequency reaches the value set in parameter 409 (DC Inj Freq). If the frequency at the time of a Stop command is less than that of DC Inj Freq, DC braking begins immediately. The braking continues for the time period specified by parameter DC Inj Freq. Once the time period elapses, the drive may be restarted.</p> <table border="1"> <thead> <tr> <th><u>Parameter Value</u></th> <th><u>Description</u></th> </tr> </thead> <tbody> <tr> <td>DC at Stop</td> <td>DC inject only on Stop</td> </tr> <tr> <td>DC at Start</td> <td>DC inject only on Start</td> </tr> <tr> <td>DC at Both</td> <td>DC inject only on both Start and Stop</td> </tr> <tr> <td>DC on Freq</td> <td>DC inject only on Stop below the set frequency</td> </tr> </tbody> </table>			<u>Parameter Value</u>	<u>Description</u>	DC at Stop	DC inject only on Stop	DC at Start	DC inject only on Start	DC at Both	DC inject only on both Start and Stop	DC on Freq	DC inject only on Stop below the set frequency
<u>Parameter Value</u>	<u>Description</u>											
DC at Stop	DC inject only on Stop											
DC at Start	DC inject only on Start											
DC at Both	DC inject only on both Start and Stop											
DC on Freq	DC inject only on Stop below the set frequency											
407 DC Inject Time	Default: 0.2 sec	Range: 0.0 to 5.0 sec Level 2										
<p>If parameter 406 is set to DC at Stop (see page 82), direct current is applied to the motor. This parameter, DC Inject Time, determines how long the direct current will be applied, and how long DC is applied at Start if programmed accordingly.</p> <p>This parameter works in tandem with parameter 410 (DC Inject Config) and the other parameters associated with DC Inject Config. That is, the time period configured by this parameter, DC Inject Time, determines how long DC injection braking will be active. When DC injection braking is controlled by a digital input, the braking continues for as long as the digital input is true, plus the time set by parameter 407 (DC Inject Time). When it is controlled by frequency, however, it continues for the length of time once the drive reaches the frequency set by parameter 409 (DC Inj Freq).</p>												
408 DC Inject Level	Default: 50.0%	Range: 0.0% to 100.0% Level 2										
<p>Configures the amount of DC injection that will occur when direct current is injected into the motor windings, which acts as a braking force. The amount of current is expressed as a percentage of nominal motor current. The braking force may be applied when starting or stopping. If this parameter is set to 0.0%, the DC injection is disabled.</p>												
409 DC Inj Freq	Default: 0 Hz	Range: 0.0 to 20.0 Hz Level 2										
<p>Configures the frequency under which direct current will be applied to the drive when DC Inject Config is set to "DC on Freq." If this parameter is set to 0.0, the parameter operates in the same way as "DC at Stop."</p>												

Table 7-2: Description of X5 Parameters (Page 13 of 40)

410 DB Config	Default: DB Internal	Range: n/a Level 2										
<p>Determines whether an external or internal dynamic brake is utilized or disabled. The drive provides an internal dynamic brake (DB) to assist in stopping. If desired, an external resistor can be connected to DB and B+ for additional capacity.</p> <p>The following data values may be assigned to this parameter:</p> <table border="0"> <thead> <tr> <th data-bbox="315 464 475 485">Parameter Value</th> <th data-bbox="505 464 610 485">Description</th> </tr> </thead> <tbody> <tr> <td data-bbox="315 499 415 520">DB Internal</td> <td data-bbox="505 499 784 520">Internal dynamic braking active</td> </tr> <tr> <td data-bbox="315 527 415 548">DB External</td> <td data-bbox="505 527 784 548">External dynamic braking active</td> </tr> <tr> <td data-bbox="315 579 415 600">No Dyn Brk</td> <td data-bbox="505 579 784 600">Dynamic braking circuit disabled</td> </tr> <tr> <td data-bbox="315 606 415 627">Int-ARCTIC</td> <td data-bbox="505 606 1414 825"> <p>When DB Config is configured to "Int-ARCTIC," dynamic braking becomes active if the internal control board temperature drops below -7 degrees C. When the DB becomes active, an "ARCTIC Mode" warning flashes on the keypad. If the board temperature drops below -10 degrees C, the drive will be disabled and not allowed to run. The keypad will indicate a "Not enabled" state at this point. If the board temperature heats up after being below -10 degrees C, the drive must meet these criteria before operating again:</p> <ul style="list-style-type: none"> a) Board temperature must be above -9 degrees C, and b) Board temperature must stay above -9 degrees C until a time period has elapsed. The time period is dependent on how far below -10 degrees C the board was. Each degree below -10 degrees C adds another 4 minutes before restart. </td> </tr> </tbody> </table>			Parameter Value	Description	DB Internal	Internal dynamic braking active	DB External	External dynamic braking active	No Dyn Brk	Dynamic braking circuit disabled	Int-ARCTIC	<p>When DB Config is configured to "Int-ARCTIC," dynamic braking becomes active if the internal control board temperature drops below -7 degrees C. When the DB becomes active, an "ARCTIC Mode" warning flashes on the keypad. If the board temperature drops below -10 degrees C, the drive will be disabled and not allowed to run. The keypad will indicate a "Not enabled" state at this point. If the board temperature heats up after being below -10 degrees C, the drive must meet these criteria before operating again:</p> <ul style="list-style-type: none"> a) Board temperature must be above -9 degrees C, and b) Board temperature must stay above -9 degrees C until a time period has elapsed. The time period is dependent on how far below -10 degrees C the board was. Each degree below -10 degrees C adds another 4 minutes before restart.
Parameter Value	Description											
DB Internal	Internal dynamic braking active											
DB External	External dynamic braking active											
No Dyn Brk	Dynamic braking circuit disabled											
Int-ARCTIC	<p>When DB Config is configured to "Int-ARCTIC," dynamic braking becomes active if the internal control board temperature drops below -7 degrees C. When the DB becomes active, an "ARCTIC Mode" warning flashes on the keypad. If the board temperature drops below -10 degrees C, the drive will be disabled and not allowed to run. The keypad will indicate a "Not enabled" state at this point. If the board temperature heats up after being below -10 degrees C, the drive must meet these criteria before operating again:</p> <ul style="list-style-type: none"> a) Board temperature must be above -9 degrees C, and b) Board temperature must stay above -9 degrees C until a time period has elapsed. The time period is dependent on how far below -10 degrees C the board was. Each degree below -10 degrees C adds another 4 minutes before restart. 											
⚠ CAUTION												
<p>MOTOR OVERHEATING</p> <p>Do not use DC injection braking as a holding brake, or excessive motor heating may result.</p> <p>Failure to observe this instruction can result in equipment damage.</p>												
⚠ ATTENTION												
<p>SURCHAUFFE DU MOTEUR</p> <p>N'utilisez pas le freinage CC comme frein de maintien car cela peut entraîner une surchauffe excessive du moteur.</p> <p>Si cette directive n'est pas respectée, cela peut entraîner des dommages matériels.</p>												
414 S Ramp Rounding	Default: 25%	Range: 1-100% Level 2										
<p>This parameter defines the amount of rounding or S-curve to the Accel and Decel ramp. The amount of rounding is split evenly between the beginning and the end of the ramp. A value of 1% would mean that the rounding of the ramp is near linear. A value of 50% would have 25% rounding at the start of the ramp and 25% at the end of the ramp.</p>												
415 Accel Time 3	Default: 10.0 s	Range: 0.1 to 3200.0 s Level 2										
<p>This parameter provides an alternate ramping time for the drive when accelerating, configuring the length of time to accelerate from 0 Hz to the value of parameter 302 (Max Frequency). This acceleration ramp is selected by parameter 401 (Ramp Select) or Sequencer Configuration.</p> <p>Note that extremely short acceleration times may result in nuisance fault trips.</p>												
416 Decel Time 3	Default: 10.0 s	Range: 0.1 to 3200.0 s Level 2										
<p>This parameter provides an alternate ramping time for the drive when decelerating, configuring the length of time to decelerate from the value of parameter 302 (Max Frequency) to 0 Hz. This deceleration ramp is selected by parameter 401 (Ramp Select) or Sequencer Configuration.</p> <p>Note that extremely short deceleration times may result in nuisance fault trips or may require an external dynamic brake or regen current limit.</p>												

Table 7-2: Description of X5 Parameters (Page 14 of 40)

417 Accel Time 4	Default: 15.0 s	Range: 0.1 to 3200.0 s Level 2																								
<p>This parameter provides an alternate ramping time for the drive when accelerating, configuring the length of time to accelerate from 0 Hz to the value of parameter 302 (Max Frequency). This acceleration ramp is selected by parameter 401 (Ramp Select) or Sequencer Configuration.</p> <p>Note that extremely short acceleration times may result in nuisance fault trips.</p>																										
418 Decel Time 4	Default: 15.0 s	Range: 0.1 to 3200.0 s Level 2																								
<p>This parameter provides an alternate ramping time for the drive when decelerating, configuring the length of time to decelerate from the value of parameter 302 (Max Frequency) to 0 Hz. This deceleration ramp is selected by parameter 401 (Ramp Select) or Sequencer Configuration.</p> <p>Note that extremely short deceleration times may result in nuisance fault trips or may require an external dynamic brake or regen current limit.</p>																										
490 Appl Macro	Default: 0 (Factory)	Range: n/a Macro																								
<p>This parameter configures what macro will be active in the drive. A macro will change a default or the visibility of a parameter.</p> <table border="1"> <thead> <tr> <th><u>Parameter Value</u></th> <th><u>Description</u></th> </tr> </thead> <tbody> <tr> <td>0</td> <td>Factory</td> </tr> <tr> <td>1</td> <td>Fan</td> </tr> <tr> <td>2</td> <td>Fan w/ PID</td> </tr> <tr> <td>3</td> <td>Pump</td> </tr> <tr> <td>4</td> <td>Pump w/ PID</td> </tr> <tr> <td>5</td> <td>Vector</td> </tr> </tbody> </table>			<u>Parameter Value</u>	<u>Description</u>	0	Factory	1	Fan	2	Fan w/ PID	3	Pump	4	Pump w/ PID	5	Vector										
<u>Parameter Value</u>	<u>Description</u>																									
0	Factory																									
1	Fan																									
2	Fan w/ PID																									
3	Pump																									
4	Pump w/ PID																									
5	Vector																									
491 Seq Appl	Default: 0 (Disabled)	Range: n/a Macro																								
<p>This parameter configures whether sequencer parameters are visible, and it also defines the time base of the sequencer. The time base may change depending on the drive's timing loops.</p> <table border="1"> <thead> <tr> <th><u>Parameter Value</u></th> <th><u>Description</u></th> </tr> </thead> <tbody> <tr> <td>0</td> <td>Disabled</td> </tr> <tr> <td>1</td> <td>1 sec base</td> </tr> <tr> <td>2</td> <td>.1 sec base</td> </tr> <tr> <td>3</td> <td>.01 sec base</td> </tr> </tbody> </table>			<u>Parameter Value</u>	<u>Description</u>	0	Disabled	1	1 sec base	2	.1 sec base	3	.01 sec base														
<u>Parameter Value</u>	<u>Description</u>																									
0	Disabled																									
1	1 sec base																									
2	.1 sec base																									
3	.01 sec base																									
492 SIO Visible	Default: 0 (No)	Range: n/a Macro																								
<p>This parameter configures whether SIO parameters are visible.</p> <p>Options are 0 (No) and 1 (Yes).</p> <p>The following parameters are made visible if this option is set to Yes:</p> <table border="1"> <tbody> <tr> <td>SIO Protocol (900)</td> <td>Status Word (908)</td> <td>FBus Write 3 (892)</td> </tr> <tr> <td>SIO Baudrate (901)</td> <td>FBus Read 1 (880)</td> <td>FBus Write 4 (893)</td> </tr> <tr> <td>Comm Drop # (902)</td> <td>FBus Read 2 (881)</td> <td>FBus Write 5 (894)</td> </tr> <tr> <td>Infrared Baud (916)</td> <td>FBus Read 3 (882)</td> <td>SIO Vmet Level (920)</td> </tr> <tr> <td>SIO Timer (903)</td> <td>FBus Read 4 (883)</td> <td>SIO Imet Level (921)</td> </tr> <tr> <td>SIO Cntl Word (904)</td> <td>FBus Read 5 (884)</td> <td>Status Word 2 (926)</td> </tr> <tr> <td>Ext Ref Freq 1 (905)</td> <td>FBus Write 1 (890)</td> <td>Cntl Word 2 (907)</td> </tr> <tr> <td>Ext Ref Freq 2 (906)</td> <td>FBus Write 2 (891)</td> <td>FBus Port Config (917)</td> </tr> </tbody> </table>			SIO Protocol (900)	Status Word (908)	FBus Write 3 (892)	SIO Baudrate (901)	FBus Read 1 (880)	FBus Write 4 (893)	Comm Drop # (902)	FBus Read 2 (881)	FBus Write 5 (894)	Infrared Baud (916)	FBus Read 3 (882)	SIO Vmet Level (920)	SIO Timer (903)	FBus Read 4 (883)	SIO Imet Level (921)	SIO Cntl Word (904)	FBus Read 5 (884)	Status Word 2 (926)	Ext Ref Freq 1 (905)	FBus Write 1 (890)	Cntl Word 2 (907)	Ext Ref Freq 2 (906)	FBus Write 2 (891)	FBus Port Config (917)
SIO Protocol (900)	Status Word (908)	FBus Write 3 (892)																								
SIO Baudrate (901)	FBus Read 1 (880)	FBus Write 4 (893)																								
Comm Drop # (902)	FBus Read 2 (881)	FBus Write 5 (894)																								
Infrared Baud (916)	FBus Read 3 (882)	SIO Vmet Level (920)																								
SIO Timer (903)	FBus Read 4 (883)	SIO Imet Level (921)																								
SIO Cntl Word (904)	FBus Read 5 (884)	Status Word 2 (926)																								
Ext Ref Freq 1 (905)	FBus Write 1 (890)	Cntl Word 2 (907)																								
Ext Ref Freq 2 (906)	FBus Write 2 (891)	FBus Port Config (917)																								

Table 7-2: Description of X5 Parameters (Page 15 of 40)

501 V/Hz Select	Default: Linear Fxd	Range: 0 to 7 Level 2														
<p>The V/Hz Characteristic Selection parameter determines the characteristic of the V/Hz curve and whether any boost will be applied at starting. The following data values may be assigned:</p> <table border="1"> <thead> <tr> <th>Parameter Value</th> <th>Description</th> </tr> </thead> <tbody> <tr> <td>Linear Auto</td> <td>The Linear Auto selection operates the Vector algorithm and activates current limiting functionality.</td> </tr> <tr> <td>Linear Fxd</td> <td>V/Hz curve with the amount of boost fixed at the value set in parameter 502 (Voltage Boost).</td> </tr> <tr> <td>Pump Fxd</td> <td>V/Hz curve with the amount of boost fixed at the value set in parameter 502 (Voltage Boost).</td> </tr> <tr> <td>Fan Fxd</td> <td>V/Hz curve with the amount of boost fixed at the value set in parameter 502 (Voltage Boost).</td> </tr> <tr> <td>Linear 2pc</td> <td>Activates parameters 512 (Midpoint Frq) and 513 (Midpoint Volt). These parameters are used to define a midpoint through which the V/Hz curve passes so a custom curve may be created for special motor applications.</td> </tr> <tr> <td>Vector</td> <td>Activates the sensorless vector algorithm for high torque / low speed operation. A vector-duty motor should be used for this mode of operation. Vector mode does not use the Boost parameter (parameter 502)</td> </tr> </tbody> </table>			Parameter Value	Description	Linear Auto	The Linear Auto selection operates the Vector algorithm and activates current limiting functionality.	Linear Fxd	V/Hz curve with the amount of boost fixed at the value set in parameter 502 (Voltage Boost) .	Pump Fxd	V/Hz curve with the amount of boost fixed at the value set in parameter 502 (Voltage Boost) .	Fan Fxd	V/Hz curve with the amount of boost fixed at the value set in parameter 502 (Voltage Boost) .	Linear 2pc	Activates parameters 512 (Midpoint Frq) and 513 (Midpoint Volt) . These parameters are used to define a midpoint through which the V/Hz curve passes so a custom curve may be created for special motor applications.	Vector	Activates the sensorless vector algorithm for high torque / low speed operation. A vector-duty motor should be used for this mode of operation. Vector mode does not use the Boost parameter (parameter 502)
Parameter Value	Description															
Linear Auto	The Linear Auto selection operates the Vector algorithm and activates current limiting functionality.															
Linear Fxd	V/Hz curve with the amount of boost fixed at the value set in parameter 502 (Voltage Boost) .															
Pump Fxd	V/Hz curve with the amount of boost fixed at the value set in parameter 502 (Voltage Boost) .															
Fan Fxd	V/Hz curve with the amount of boost fixed at the value set in parameter 502 (Voltage Boost) .															
Linear 2pc	Activates parameters 512 (Midpoint Frq) and 513 (Midpoint Volt) . These parameters are used to define a midpoint through which the V/Hz curve passes so a custom curve may be created for special motor applications.															
Vector	Activates the sensorless vector algorithm for high torque / low speed operation. A vector-duty motor should be used for this mode of operation. Vector mode does not use the Boost parameter (parameter 502)															
502 Voltage Boost	Default: 1.0%	Range: 0.0 to 50.0% Levels 1,2														
<p>Parameter 502, Voltage Boost, increases the motor voltage at low speed to increase the starting torque of the motor. The parameter sets the amount of boost to be applied at zero frequency. The amount of boost decreases linearly with increasing speed.</p> <p>This parameter is used when parameter 501 is set with fixed boost options.</p>																
⚠ CAUTION																
<p>MOTOR OVERHEATING</p> <p>Too much boost may cause excessive motor currents and motor overheating. Use only as much boost as is necessary to start the motor.</p> <p>Failure to observe this instruction can result in equipment damage.</p>																
⚠ ATTENTION																
<p>SURCHAUFFE DU MOTEUR</p> <p>Une amplification de puissance excessive peut entraîner des surintensités de courant et faire la surchauffe du moteur. N'utilisez que le niveau d'amplification nécessaire pour démarrer le moteur.</p> <p>Si cette directive n'est pas respectée, cela peut entraîner des dommages matériels.</p>																
503 V/Hz Knee Freq	Default: 60 Hz	Range: 25 to 400 Hz Level 2														
<p>This parameter sets the point on the frequency scale of the V/Hz curve at which the output is at full line voltage. Normally, this is set at the base frequency of the motor, but it may be increased to enlarge the constant torque range on special motors. Setting this parameter to a higher value can reduce motor losses at low frequencies.</p>																

Table 7-2: Description of X5 Parameters (Page 16 of 40)

504 Skip Freq Band	Default: 0.2 Hz	Range: 0.2 to 20.0 Hz Level 2
<p>To reduce mechanical resonances in a drive system, the drive may be configured to “skip” certain frequencies. Once configured, the drive will accelerate or decelerate through the prohibited frequency band without settling on any frequency in the band.</p> <p>The X5 AC drive provides the capability to configure four prohibited frequency bands. Parameter 504 (Skip Freq Band), the Skip Frequency Band parameter, sets the width of the band above and below each of the prohibited frequencies set in parameters 505, 506, 507, and 508 (Skip Freq 1,2,3, 4).</p> <p>For example, if this parameter is set to its default value of 1 Hz and parameter 505 (Skip Freq 1) is set to 20 Hz, a skip band from 19 to 21 Hz is established.</p>		
505 Skip Freq 1 506 Skip Freq 2 507 Skip Freq 3 508 Skip Freq 4	Default: 0.0 Hz	Range: Min Freq-Max Freq Level 2
<p>As discussed in the description of parameter 504 (Skip Freq Band), the drive may be configured to skip certain frequencies. These three parameters set the center of the three skip frequency bands (with the width of each band being twice the value of parameter 504 — an equal amount above and below the skip frequency).</p> <p>For example, if parameter 504 is set to 2.5 Hz and parameter 508 (Skip Freq 4) is set to 55 Hz, a skip band from 52.5 to 57.5 Hz is established.</p>		
509 Rated Mtr Volt	Default: Model dependent	Range: 100 V - 690 V Level 2, Macro
<p>The Rated Motor Voltage parameter configures the rated motor voltage, and allows a user to enter the rated voltage from the motor nameplate to provide optimal control and protection. This is usually the amount of voltage delivered to the motor terminals at the setting of 503 (V/Hz Knee Freq).</p>		
510 Rated Mtr FLA	Default: ND Rating	Range: 50% - 200% of ND rating Level 2, Macro
<p>The Rated Motor FLA parameter allows a user to enter the rated FLA from the motor nameplate to provide optimal control and protection. This parameter should be configured to the value on the nameplate of the motor, as that value is used in calculating the percentage of current at which the drive is operating.</p> <p>For information on motor timed overload operation, and how Parameter 510 works with it, see page 90.</p>		
511 Rated Mtr RPM	Default: 1750 rpm	Range: 0-24000 rpm Level 2, Macro
<p>This parameter replaces the slip compensation parameter setting of the drive so the user does not need to calculate it.</p>		
512 Midpoint Freq	Default: 60.0 Hz	Range: 0.0 Hz-V/Hz Knee Freq Level 2
<p>When parameter 501, V/Hz Select, is configured to “Linear 2pc,” this parameter, together with parameter 513, Midpoint Volt, defines an additional point in the V/Hz characteristic.</p>		
513 Midpoint Volt	Default: 100.0%	Range: 0.0%-100.0% Level 2
<p>When parameter 501, V/Hz Select, is configured to “Linear 2pc,” this parameter, along with parameter 512, Midpoint Freq, defines an additional point in the V/Hz characteristic.</p>		
514 Motor RS	Default: Model dependent	Range: 0.00-655.35 Ohms Level 2, Macro
<p>This parameter allows direct entry of the Stator Resistance (Rs) of the motor for better vector performance. The motor manufacturer can provide this information.</p>		
515 Power Factor	Default: 0.80	Range: 0.50 - .99 Level 2, Macro
<p>This parameter allows direct entry of the motor's power factor for better vector performance. The motor manufacturer can provide this information.</p>		

Table 7-2: Description of X5 Parameters (Page 17 of 40)

516 Slip Comp Enable	Default: No	Range: n/a Level 1,2						
<p>This parameter is accessible through Macro modes, or through parameter 501 (V/Hz Select) and choosing Vector mode. It is only visible if the drive is in a vector-capable mode; otherwise, it is hidden. The following data values may be assigned to this parameter:</p> <table border="1"> <thead> <tr> <th><u>Parameter Value</u></th> <th><u>Description</u></th> </tr> </thead> <tbody> <tr> <td>No</td> <td>No Slip Compensation enabled</td> </tr> <tr> <td>Yes</td> <td>Slip Compensation enabled</td> </tr> </tbody> </table> <p>Parameter 516 permits activation of slip compensation for better speed regulation. The motor rated speed must be entered into parameter 511 (Rated Mtr RPM) for best results.</p>			<u>Parameter Value</u>	<u>Description</u>	No	No Slip Compensation enabled	Yes	Slip Compensation enabled
<u>Parameter Value</u>	<u>Description</u>							
No	No Slip Compensation enabled							
Yes	Slip Compensation enabled							
517 Single Phase	Default: No	Range: n/a Level 2						
<p>This parameter determines whether or not Phase Loss faults will occur.</p> <p>The following data values may be assigned to this parameter:</p> <table border="1"> <thead> <tr> <th><u>Parameter Value</u></th> <th><u>Description</u></th> </tr> </thead> <tbody> <tr> <td>No</td> <td>No single phase input operation. Phase loss engaged.</td> </tr> <tr> <td>Yes</td> <td>Single phase operation. No phase loss.</td> </tr> </tbody> </table>			<u>Parameter Value</u>	<u>Description</u>	No	No single phase input operation. Phase loss engaged.	Yes	Single phase operation. No phase loss.
<u>Parameter Value</u>	<u>Description</u>							
No	No single phase input operation. Phase loss engaged.							
Yes	Single phase operation. No phase loss.							
519 Find Mtr Data	Default: Not active	Range: n/a Macro						
<p>This parameter activates the drive's ability to measure the stator resistance of the attached motor. The automatic stator resistance measurement can be performed either through the keypad or through the serial link. See "Measuring Stator Resistance (RS Measurement)" on page 51 for more information about this parameter. The following data values may be assigned:</p> <table border="1"> <thead> <tr> <th><u>Parameter Value</u></th> <th><u>Description</u></th> </tr> </thead> <tbody> <tr> <td>Not Active</td> <td>No stator RS measurement.</td> </tr> <tr> <td>Motor RS</td> <td>Automatic RS measurement using macro procedure.</td> </tr> </tbody> </table>			<u>Parameter Value</u>	<u>Description</u>	Not Active	No stator RS measurement.	Motor RS	Automatic RS measurement using macro procedure.
<u>Parameter Value</u>	<u>Description</u>							
Not Active	No stator RS measurement.							
Motor RS	Automatic RS measurement using macro procedure.							
520 Filter FStator	Default: 8 ms	Range: 1 - 100 ms Level 2 (SVC)						
<p>This parameter filters the stator frequency applied to the motor, which can help tune the acceleration behavior of the motor. This is particularly helpful when using short ramps and operating the motor at a frequency above the "V/Hz Knee Freq" (parameter 503) value (field weakening area). Lower values allow dynamic currents to be produced, but with greater peaks. This could produce unstable states in the field weakening area. Low values for this parameter can cause overcurrent faults while accelerating to frequencies over the Knee Frequency. Higher values allow the drive to run more smoothly at frequencies over the Knee Frequency and protect the drive against overcurrents--often the case when using special motors or spindle drives. This parameter is only visible if the drive is in a vector-capable mode.</p>								
521 Start Field En	Default: No	Range: n/a Level 2 (SVC)						
<table border="1"> <thead> <tr> <th><u>Parameter Value</u></th> <th><u>Description</u></th> </tr> </thead> <tbody> <tr> <td>No</td> <td>The shaft will begin rotating after receiving a Start command, without delay. If the application has heavy load conditions or short ramp times, this setting can produce very large starting currents, to overcome the inertia of the system. This may produce nuisance trips when starting.</td> </tr> <tr> <td>Yes</td> <td>The shaft will begin rotating after receiving a Start command, with delay. During this delay, the drive is building up the magnetic field in the motor. This allows the drive to start in vector mode with less starting current.</td> </tr> </tbody> </table> <p>This parameter is only visible if the drive is in a vector-capable mode; otherwise, it is hidden.</p>			<u>Parameter Value</u>	<u>Description</u>	No	The shaft will begin rotating after receiving a Start command, without delay. If the application has heavy load conditions or short ramp times, this setting can produce very large starting currents, to overcome the inertia of the system. This may produce nuisance trips when starting.	Yes	The shaft will begin rotating after receiving a Start command, with delay. During this delay, the drive is building up the magnetic field in the motor. This allows the drive to start in vector mode with less starting current.
<u>Parameter Value</u>	<u>Description</u>							
No	The shaft will begin rotating after receiving a Start command, without delay. If the application has heavy load conditions or short ramp times, this setting can produce very large starting currents, to overcome the inertia of the system. This may produce nuisance trips when starting.							
Yes	The shaft will begin rotating after receiving a Start command, with delay. During this delay, the drive is building up the magnetic field in the motor. This allows the drive to start in vector mode with less starting current.							

Table 7-2: Description of X5 Parameters (Page 18 of 40)

522 Filter Time Slip	Default: 100 ms	Range: 10 - 1000 ms Level 2 (SVC)														
<p>This parameter filters the slip frequency applied to the motor, which can help improve the dynamic response of the drive. It is only visible if the drive is in a vector-capable mode; otherwise, it is hidden. This parameter produces the following results based on the parameter value:</p> <p>If the parameter is configured to 100 ms, the drive will produce stable conditions to a change in load, in most cases.</p> <p>If the parameter is configured to less than 100 ms, the drive will be able to react quickly to a change in load, but may over-compensate its reaction to the load.</p> <p>If the parameter is configured to greater than 100 ms, the drive will react very slowly to a change in load and will need a longer time to compensate for the difference between the setpoint and the actual frequency.</p>																
523 Id Percent	Default: Read-only	Range: 0 - 200% Level 2 (SVC)														
<p>This parameter shows the Flux producing current (as a percentage of motor rated current) that is being applied to the drive. The parameter is only visible if the drive is in a vector-capable mode; otherwise, it is hidden.</p>																
524 Iq Percent	Default: Read-only	Range: 0 - 200% Level 2 (SVC)														
<p>This parameter shows the Torque producing current (as a percentage of motor rated current) that is being applied to the drive. The parameter is only visible if the drive is in a vector-capable mode; otherwise, it is hidden.</p>																
525 Power Fail Config	Default: (5) CTS No Msg	Range: n/a Level 2 (SVC)														
<p>This parameter can be used to define how the drive responds to an undervoltage operation when parameter 501 is set for Vector or Linear Auto mode. This parameter is only visible if the drive is in a vector-capable mode; otherwise, it is hidden. The following data values may be assigned to this parameter:</p> <table border="1"> <thead> <tr> <th><u>Parameter Value</u></th> <th><u>Description</u></th> </tr> </thead> <tbody> <tr> <td>(0) Coast Stop</td> <td>The drive will coast to a stop when an undervoltage condition (power-down) is detected. In this mode, however, the drive will generate an undervoltage fault, which will be registered in the fault log.</td> </tr> <tr> <td>(1) Ramp Down</td> <td>With this setting, if power is lost, the drive ramps the motor down at a decel rate of Decel 1. When the drive is fully ramped down, the drive will generate an undervoltage fault. If power is restored, the drive will continue to ramp to a stop and will fault.</td> </tr> <tr> <td>(2) Quick Ramp</td> <td>Same as Ramp Down, except the shorter ramp time (Decel 1 or Decel 2) will be used.</td> </tr> <tr> <td>(3) Controlled</td> <td>With this setting, if power is lost, the drive decelerates the motor, trying to regulate the bus voltage to the undervoltage level. If power is restored, the drive accelerates to the command frequency without faulting. If the drive reaches the stopped condition, it will generate an undervoltage fault.</td> </tr> <tr> <td>(4) ContrNoMsg</td> <td>Same as Controlled, but without generating an undervoltage fault.</td> </tr> <tr> <td>(5) CTS No Msg</td> <td>The drive will coast to a stop when an undervoltage condition (power-down) is detected.</td> </tr> </tbody> </table> <p>Note: If parameter 501 is set to Vector, then the Current Limiting values will actually be Torque Limiting values.</p>			<u>Parameter Value</u>	<u>Description</u>	(0) Coast Stop	The drive will coast to a stop when an undervoltage condition (power-down) is detected. In this mode, however, the drive will generate an undervoltage fault, which will be registered in the fault log.	(1) Ramp Down	With this setting, if power is lost, the drive ramps the motor down at a decel rate of Decel 1 . When the drive is fully ramped down, the drive will generate an undervoltage fault. If power is restored, the drive will continue to ramp to a stop and will fault.	(2) Quick Ramp	Same as Ramp Down, except the shorter ramp time (Decel 1 or Decel 2) will be used.	(3) Controlled	With this setting, if power is lost, the drive decelerates the motor, trying to regulate the bus voltage to the undervoltage level. If power is restored, the drive accelerates to the command frequency without faulting. If the drive reaches the stopped condition, it will generate an undervoltage fault.	(4) ContrNoMsg	Same as Controlled, but without generating an undervoltage fault.	(5) CTS No Msg	The drive will coast to a stop when an undervoltage condition (power-down) is detected.
<u>Parameter Value</u>	<u>Description</u>															
(0) Coast Stop	The drive will coast to a stop when an undervoltage condition (power-down) is detected. In this mode, however, the drive will generate an undervoltage fault, which will be registered in the fault log.															
(1) Ramp Down	With this setting, if power is lost, the drive ramps the motor down at a decel rate of Decel 1 . When the drive is fully ramped down, the drive will generate an undervoltage fault. If power is restored, the drive will continue to ramp to a stop and will fault.															
(2) Quick Ramp	Same as Ramp Down, except the shorter ramp time (Decel 1 or Decel 2) will be used.															
(3) Controlled	With this setting, if power is lost, the drive decelerates the motor, trying to regulate the bus voltage to the undervoltage level. If power is restored, the drive accelerates to the command frequency without faulting. If the drive reaches the stopped condition, it will generate an undervoltage fault.															
(4) ContrNoMsg	Same as Controlled, but without generating an undervoltage fault.															
(5) CTS No Msg	The drive will coast to a stop when an undervoltage condition (power-down) is detected.															
526 UV Ride-Thru En	Default: w/ LVT	Range: n/a Level 2 (SVC)														
<p>This parameter allows the function to disable either (a) undervoltage ride-through or (b) continuous Line Voltage Tracking (LVT) that produces dynamic Undervoltage Ride-Thru Thresholds. The following data values may be assigned to this parameter:</p> <table border="1"> <thead> <tr> <th><u>Parameter Value</u></th> <th><u>Description</u></th> </tr> </thead> <tbody> <tr> <td>Disabled</td> <td>This turns off the Undervoltage Ride-Thru function.</td> </tr> <tr> <td>w/ LVT</td> <td>This enables the standard Ride-Thru algorithm in the V/Hz modes and allows the choice of algorithm in the Linear Auto and Vector modes.</td> </tr> <tr> <td>w/o LVT</td> <td>This option operates in the same way as "w/ LVT" except that the Line Voltage Tracker function of the Undervoltage Ride-Thru is not active. The Line Voltage is estimated on powering up the drive.</td> </tr> <tr> <td>No UV Fault</td> <td>With this option, the drive will do all it can to provide uninterrupted operation through UV events, but a UV fault will not be generated.</td> </tr> </tbody> </table>			<u>Parameter Value</u>	<u>Description</u>	Disabled	This turns off the Undervoltage Ride-Thru function.	w/ LVT	This enables the standard Ride-Thru algorithm in the V/Hz modes and allows the choice of algorithm in the Linear Auto and Vector modes.	w/o LVT	This option operates in the same way as "w/ LVT" except that the Line Voltage Tracker function of the Undervoltage Ride-Thru is not active. The Line Voltage is estimated on powering up the drive.	No UV Fault	With this option, the drive will do all it can to provide uninterrupted operation through UV events, but a UV fault will not be generated.				
<u>Parameter Value</u>	<u>Description</u>															
Disabled	This turns off the Undervoltage Ride-Thru function.															
w/ LVT	This enables the standard Ride-Thru algorithm in the V/Hz modes and allows the choice of algorithm in the Linear Auto and Vector modes.															
w/o LVT	This option operates in the same way as "w/ LVT" except that the Line Voltage Tracker function of the Undervoltage Ride-Thru is not active. The Line Voltage is estimated on powering up the drive.															
No UV Fault	With this option, the drive will do all it can to provide uninterrupted operation through UV events, but a UV fault will not be generated.															

Table 7-2: Description of X5 Parameters (Page 19 of 40)

600 Current Lim Sel	Default: Fixed Lvl's	Range: n/a Level 2
<p>The X5 drive provides a Current Limit feature. With this feature enabled, the drive's frequency is automatically reduced when operating in motoring mode to keep the measured torque within limits. When operating in regenerative mode, the output frequency can be automatically increased for the same reason. In addition to the current limit parameters that activate the Current Limit mode, more current limit parameters are available to adjust the drive's response to the load demands. The following data values may be assigned to this parameter:</p> <p><u>Parameter Value</u> <u>Description</u></p> <p>Fixed Lvl's The fixed levels set in parameters 601, 602, 603 and 604 determine the current limit in each of the four quadrants of operation.</p> <p>Vin2 Vin2 analog input sets the current limit value, range 0-200%</p> <p>Cin Cin analog input sets the current limit value, range 0-200%</p> <p>Vin2 Motor Vin2 analog input sets the motoring current limit value, range 0-200%</p> <p>Cin Motor Cin analog input sets the motoring current limit value, range 0-200%</p> <p>Vin2 F-Mtr Vin2 analog input sets the FWD motoring current limit value, range 0-200%</p> <p>Cin F-Motor Cin analog input sets the FWD motoring current limit value, range 0-200%</p> <p>Note: Current limit is only available when parameter 501 is set to Linear Auto. If parameter 501 is set to Vector, then the Current Limiting values will actually be Torque Limiting values.</p>		
601 Cur Lim Mtr Fwd	Default: 120%	Range: 5-150% Level 2
<p>This parameter sets the current limiting point when the drive is in motoring mode in the forward direction. The limit is expressed as a percentage of the current capacity of the drive.</p>		
602 Cur Lim Mtr Rev	Default: 120%	Range: 5-150% Level 2
<p>This parameter sets the current limiting point when the drive is in motoring mode in the reverse direction. The limit is expressed as a percentage of the current capacity of the drive.</p>		
603 Cur Lim Reg Fwd	Default: 80%	Range: 5-150% Level 2
<p>This parameter sets the current limiting point when the drive is in regenerative mode in the forward direction. The limit is expressed as a percentage of the current capacity of the drive.</p>		
604 Cur Lim Reg Rev	Default: 80%	Range: 5-150% Level 2
<p>This parameter sets the current limiting point when the drive is in regenerative mode in the reverse direction. The limit is expressed as a percentage of the current capacity of the drive.</p>		
605 Cur Lim Freq	Default: 3.0 Hz	Range: 0.0 - 400.0 Hz Level 2
<p>This parameter sets the frequency where current limit becomes active. This value will also be the frequency point the drive will decelerate the motor to during Motoring Current Limit.</p>		
606 Ramp Time CL	Default: 1.0 sec	Range: 0.1-3200.0 sec Level 2
<p>This parameter determines the ramp rate when the drive enters Current Limit, and defines the ramping rate of the drive when in a current limiting mode. If the drive is in regenerative current limit, it is an acceleration time. If the drive is in motoring current limit, it is a deceleration time.</p>		
607 Cur Lim Minimum	Default: 10%	Range: 0 - 50% Level 2
<p>This parameter limits the lowest amount of current (or Torque) limiting that can occur when the limit threshold is determined by an analog input.</p>		

Table 7-2: Description of X5 Parameters (Page 20 of 40)

608 Restart Number	Default: 0	P608 Range: 0-8
609 Restart Delay	Default: 60 sec	P609 Range: 0-60 sec Level 2

You may configure the drive to attempt to re-start a specified number of times after certain faults occur. Chapter 8 lists all faults and notes which ones may be reset automatically.

The number of attempts at re-starting is set with parameter **608 (Restart Number)**. A value of 0 prevents the drive from attempting a re-start. The time duration that must elapse between re-start attempts is set with parameter **609 (Restart Delay)**. The type of start to be attempted is set with parameter **802 (Start Options)**; see [page 99](#).

If the number of attempted re-starts is exceeded, the drive will trip with a fault and will stop operating. **Resetting the fault can result in instant starting.** (See [page 125](#) for more information on faults and troubleshooting.)

Note that for 2-wire operation, the FWD or REV terminal must still be active for the drive to attempt a re-start.

Also note that the counter for attempted re-starts will not reset to zero until ten minutes after a successful re-start.

⚠ WARNING

UNINTENDED EQUIPMENT ACTION

Ensure that automatic re-starting will not cause injury to personnel or damage to equipment.

Failure to observe this instruction can result in serious injury or equipment damage.

⚠ AVERTISSEMENT

ACTIONNEMENT INVOLONTAIRE DE L'APPAREIL

Assurez-vous qu'un redémarrage automatique n'entraînera ni des blessures au personnel ni des dommages matériels.

Si cette directive n'est pas respectée, cela peut entraîner des blessures graves ou des dommages matériels.

610 Timed OL Select	Default: Std Ind 60s	Range: 0-7 Level 2
----------------------------	----------------------	-----------------------

Two parameters in the X5 work together to configure how the motor timed overload operates: parameter **510 (Rated Mtr FLA)** and parameter **610 (Timed OL Select)**.

Parameter **510 (Rated Mtr FLA)** should be configured to the value on the nameplate of the motor. This value is used in calculating the percentage of current at which the drive is operating.

Set parameter **610** to one of the following data values to configure the desired overload characteristic:

<u>Options</u>	<u>Trip Time</u>	<u>Motor Type</u>	<u>Motor Class</u>
Std Ind Shp	0 sec	Standard Induction	N/A
Std Ind 30s	30 sec	Standard Induction	1
Std Ind 60s	60 sec	Standard Induction	2
Std Ind 5mn	300 sec	Standard Induction	10
In Duty Shp	0 sec	Inverter Duty	N/A
In Duty 30s	30 sec	Inverter Duty	1
In Duty 60s	60 sec	Inverter Duty	2
In Duty 5mn	300 sec	Inverter Duty	10

Parameter **610 (Timed OL Select)** determines the graph of Trip (Fault) Time vs. Percent Current that is used by the Motor TOL functionality. This protective feature is speed-dependent to handle standard induction motors whose cooling is limited by the shaft-mounted fan. Blower-cooled motors and most inverter-duty motors do not have this limitation.

Table 7-2: Description of X5 Parameters (Page 21 of 40)

613 Max Regen Ramp	Default: 300%	Range: 100 - 1001% Level 2
This parameter operates as a percentage of the longest ramp time. This time then defines the amount of time a deceleration to stop can take without causing a "Regen Timeout" fault. For example, if "Decel Time 1" is 5.0 seconds, "Decel Time 2" is 10.0 seconds, and "Max Regen Ramp" is 300%, a deceleration to stop that takes more than 30 seconds will cause a "Regen Timeout" fault in the drive.		
614 Stability Gain 615 Stability Rate	Default: Model dependent	Range: 0-10 Range: 0-1000 Level 2
Both of these parameters can be used to resolve stability problems if they occur. Use Parameter 615 if the load has significant inertia with respect to the motor itself.		
700 Vmet Config	Default: Freq Out	Range: n/a Levels 1,2
This parameter configures the analog signal that will be applied to the Vmet output pin. The following data values may be assigned to this parameter:		
<u>Para. Value</u>	<u>Description</u>	<u>Range Limit</u>
Freq Out	Output frequency of the drive	Parameter max freq.
Voltage Out	Voltage being supplied to the motor	Rated motor voltage
Current Out	Current being supplied to the motor	200% of drive rating
Drive Load	Calculated percentage of drive rating	200% of drive rating
Drive Temp	Calculation of total drive temp rating	100% of unit temp rating
Stator Freq	Commanded frequency	100% of input config
Power Out	Calculated power output of drive	250% of drive rating
+/- Load	Percentage torque of drive (see parameter 105)	-200 to +200% of drive rating
PID Fback	Allows the analog output to produce a signal in proportion to the PID feedback received.	
Vin 1	Mirrors the status of the Vin1 input (see parameter 910)	0-100%
Cin	Mirrors the status of the Cin input (see parameter 911)	0-100%
Vin 2	Mirrors the status of the Vin2 input (see parameter 912)	0-100%
SIO Config	Allows the serial port to set the Vmet analog output through parameter 920 (SIO Vmet Level) along with parameter 907 (Control Word 2)	
Encoder	Monitors the status of an encoder connected to the drive through an option board.	
701 Vmet Span	Default: 100%	Range: 0.0%-200.0% Level 2
This parameter sets the span of the Vmet analog output.		

Table 7-2: Description of X5 Parameters (Page 22 of 40)

702 Imet Config	Default: Drive Load	Range: n/a Level 2
This parameter configures the analog signal that will be applied to the Imet output pin. The following data values may be assigned to this parameter:		
<u>Para. Value</u>	<u>Description</u>	<u>Range Limit</u>
Freq Out	Output frequency of the drive	Parameter max freq.
Voltage Out	Voltage being supplied to the motor	Rated motor voltage
Current Out	Current being supplied to the motor	200% of drive rating
Drive Load	Calculated percentage of drive rating	200% of drive rating
Drive Temp	Calculation of total drive temp rating	100% of unit temp rating
Stator Freq	Commanded frequency	100% of input config
Power Out	Calculated power output of drive	250% of drive rating
+/- Load	Percentage torque of drive (see parameter 105)	-200 to +200% of drive rating
PID Fback	Allows the analog output to produce a signal in proportion to the PID feedback received.	
Vin 1	Mirrors the status of the Vin1 input (see parameter 910)	0-100%
Cin	Mirrors the status of the Cin input (see parameter 911)	0-100%
Vin 2	Mirrors the status of the Vin2 input (see parameter 912)	0-100%
SIO Config	Allows the serial port to set the Imet analog output through parameter 921 (SIO Imet Lvl) along with parameter 907 (Control Word 2)	
Encoder	Monitors the status of an encoder connected to the drive through an option board.	
703 Imet Span	Default: 100%	Range: 0.0%-200.0% Level 2
This parameter sets the span of the Imet analog output.		
704 Imet Offset	Default: 0.0%	Range: 0.0%-90.0% Level 2
This parameter sets the offset of the Imet analog output.		

Table 7-2: Description of X5 Parameters (Page 23 of 40)

705 Relay 1 Select	Default: Drv Fault	Range for Parameters 705-708: n/a Levels 1, 2 for Parameters 705-706 Level 2 for Parameters 707-708
706 Relay 2 Select	Default: Drv Run	
707 DO1 Select	Default: Drv Ready	
708 DO2 Select	Default: At Speed	

These parameters configure what condition causes relays R1, R2, DO1, and DO2 to activate. Parameter **705** is associated with relay R1; **706** with relay R2; **707** with DO1; and **708** with relay DO2. The following values are valid:

Parameter Value	Description
Drv Ready	The drive is ready. (The relay will be open in Fault and Low Voltage conditions.)
Drv Fault	A fault has occurred. (If automatic fault reset and re-start is enabled, only faults that cannot be reset will activate the relay. The relay will also activate for faults that can be reset when the number of re-start attempts exceeds the value set in parameter 608 (Restart Number) .)
Drive Run	The drive has received a direction command.
Running FWD	The motor is running Forward and the output frequency is above 0.5 Hz.
Running REV	The motor is running in Reverse and the output frequency is above 0.5 Hz.
Zero Speed	The drive is in Run mode, but the speed reference is 0 Hz.
At Speed	The drive has reached reference speed.
Freq Limit	The drive limit is active when the speed commanded exceeds the value of parameter 306, Preset Freq 4 .
Freq Hyst	This is active when the speed exceeds parameter 306 (Preset Freq 4) but is less than parameter 307 (Preset Freq 5) .
Current Lim	Current Limit mode is active.
High Temp	The temperature limit of the drive has been exceeded.
Local Mode	The keypad is the control path for reference speed and control functions.
SeqOut-000	Programmed sequence step active. SeqOut-XXX values are all status outputs linked to a step in the program sequencer. See "Using the X5 Program Sequencer" on page 111 for more information.
SeqOut-001	
SeqOut-010	
SeqOut-011	
SeqOut-100	
SeqOut-101	
SeqOut-110	
SeqOut-111	
Thres 1	Active status of Threshold 1 for this output (see parameter 740 on page 96)
Thres 2	Active status of Threshold 2 for this output (see parameter 743 on page 97)
Timer 1	Active status of Timer 1 for this output (see parameter 746 on page 97)
Timer 2	Active status of Timer 2 for this output (see parameter 749 on page 97)
ARCTIC	When a digital output is configured to use this option, the output will be active when the Arctic Mode is turning on the DB resistor. This option will turn on when the temperature drops below the Arctic mode entry point, which is -7 degrees C. This will work even if Arctic Mode is not enabled.
DI-FWD	DI-xxx values all refer to inputs on option cards; when the respective input is active, the respective output listed here is set.
DI-REV	
DI-R/J	
DI-EN	
DI-MOL	
D11	DI-x values all refer to inputs on the drive control board; when the respective input is active, the respective output listed here is set.
D12	
D13	
D14	
D15	
Reminder 1	User-defined reminder
Reminder 2	User-defined reminder
Reminder 3	User-defined reminder
SIO Config	Indicates the setting the output will respond to the value set in parameter 907 (Control Word 2)
TOD Inhibit	Indicates the drive is disabled based on the time set in TOD run enable parameters.

Table 7-2: Description of X5 Parameters (Page 24 of 40)

719 Digital Input Filter Time	Default: 5 msec	Range: 1-1000 msec Level 2
This parameter injects a digital filter function to all digital inputs simultaneously. It can be useful in suppressing nuisance noise problems.		
720 Active Logic	Default: Active High	Range: n/a Level 2
This parameter configures the input state of all the digital inputs except the EN digital input (which is always active high).		
<u>Parameter Value</u>	<u>Description</u>	
Active Low	Low input is true ("pull-down logic")	
Active High	High input is true ("pull-up logic")	

Table 7-2: Description of X5 Parameters (Page 25 of 40)

721 DI1 Configure 722 DI2 Configure 723 DI3 Configure 724 DI4 Configure 725 DI5 Configure 727 MOL Configure	Default: Preset 1 Default: Preset 2 Default: Preset 3 Default: Alt Ramp Default: Fault Reset Default: MOL	Range: n/a Level 2
--	--	-----------------------

Parameters **721-725** all configure the function that the digital inputs DI1-5 will perform when active. Parameter **727**, **MOL Configure**, serves as the selection for the operation of the MOL terminal. The polarity of the MOL digital input is still determined by Parameter **726**, MOL Polarity. The options for parameters **721-725**, and for parameter **727** are:

<u>Parameter Value</u>	<u>Description</u>
Preset 1	Preset Speed Input 1 (PS1).
Preset 2	Preset Speed Input 2 (PS2).
Preset 3	Preset Speed Input 3 (PS3).
Coast Stop	Activates a Coast-to-Stop condition.
DC Inject	Begins DC injection braking.
Loc/Rem	Switches from Local to Remote mode.
Alt Ramp	Activates Alternate Ramp. (See note and chart below.)
Fault Reset	Resets a fault.
EMOP+	EMOP increases speed.
EMOP-	EMOP decreases speed.
PID Enable	Enables PI control.
Ref Switch	Switches speed reference signals.
Cur Lim Dis	Disables Current Limit mode.
SL Override	Takes control away from the serial link.
Seq 1	Sequencer input 1.
Seq 2	Sequencer input 2.
Seq 3	Sequencer input 3.
Seq Dwell	Sequencer dwell mode (pause).
Seq Advance	Sequencer advance (skip).
FLY Dis	Disable Catch-on-fly operation.
CurLimMax	Maximum current limit value is selected when input is active.
MOL	Motor Overload input for external customer connection.
JOG FWD	Sets Jog to forward motion.
JOG REV	Sets Jog to reverse motion.
Not Assigned	
Preset 4	Preset Speed Input (PS4).
TOD Ovrride	Indicates the clock function is being manually overridden.
User Flt 1	Trips the drive with User Fault #1.
User Flt 2	Trips the drive with User Fault #1.
Seq 4	Sequencer input 4.
Seq 5	Sequencer input 5.
Seq Trm Run	Sequencer terminal run is active.
AltRamp2	Activates Alternate Ramp 2. (See note and chart below.)
Reset Rem 1	Resets Reminder 1
Reset Rem 2	Resets Reminder 2
Reset Rem 3	Resets Reminder 3
Rem 1 Gate	A digital input has triggered the gate for Reminder #1.
Rem 2 Gate	A digital input has triggered the gate for Reminder #2.
Rem 3 Gate	A digital input has triggered the gate for Reminder #3.

Table 7-2: Description of X5 Parameters (Page 26 of 40)

Note that Alt Ramp and Alt Ramp2 work together to choose the ramp, based on the values in the following chart:		
AltRamp2	AltRamp	Ramp Chosen
0	0	Accel Time1 / Decel Time 1
0	1	Accel Time2 / Decel Time 2
1	0	Accel Time3 / Decel Time 3
1	1	Accel Time4 / Decel Time 4

726 MOL Polarity	Default: NO Operate	Range: n/a Level 2
This parameter sets the Motor Overload input polarity. The following data values may be assigned to this parameter:		
<u>Parameter Value</u>	<u>Description</u>	
NC Operate	A normally closed connection allows the unit to operate; the drive faults when the connection opens.	
NO Operate	A normally open connection allows the unit to operate; the drive faults when the connection closes.	

740 Thres 1 Select	Default: 15 (Curr High)	Range: n/a Level 2	
This parameter selects the type of threshold to be used for Threshold 1.			
<u>Parameter Value</u>	<u>Description</u>	<u>Parameter Value</u>	<u>Description</u>
0	Vin 1 High	11	Load In
1	Vin 1 Low	12	Power High
2	Vin 1 In	13	Power Low
3	Vin 2 High	14	Power In
4	Vin 2 Low	15	Curr High
5	Vin 2 In	16	Curr Low
6	Cin High	17	Curr In
7	Cin Low	18	Enc High
8	Cin In	19	Enc Low
9	Load High	20	Enc In
10	Load Low		

For detailed information about setting up Threshold parameters, see ["Thresholds" on page 58](#).

741 Thres 1 High	Default: 100.00%	Range: -300.00% to 300.00% Level 2
This parameter sets the High Thres level for Threshold 1. For detailed information about setting up Threshold parameters, see "Thresholds" on page 58 .		
742 Thres 1 Low	Default: 0.00%	Range: -300.00% to 300.00% Level 2
This parameter sets the Low Thres level for Threshold 1. For detailed information about setting up Threshold parameters, see "Thresholds" on page 58 .		

Table 7-2: Description of X5 Parameters (Page 27 of 40)

743 Thres 2 Select	Default: 15 (Curr High)	Range: n/a Level 2
This parameter selects the type of threshold to be used for Threshold 2.		
<u>Parameter Value</u>	<u>Description</u>	<u>Parameter Value</u> <u>Description</u>
0	Vin 1 High	11 Load In
1	Vin 1 Low	12 Power High
2	Vin 1 In	13 Power Low
3	Vin 2 High	14 Power In
4	Vin 2 Low	15 Curr High
5	Vin 2 In	16 Curr Low
6	Cin High	17 Curr In
7	Cin Low	18 Enc % High
8	Cin In	19 Enc % Low
9	Load High	20 Enc % In
10	Load Low	
For detailed information about setting up Threshold parameters, see "Thresholds" on page 58 .		
744 Thres 2 High	Default: 100.00%	Range: -300.00% to 300.00% Level 2
This parameter sets the High Thres level for Threshold 2. For detailed information about setting up Threshold parameters, see "Thresholds" on page 58 .		
745 Thres 2 Low	Default: 0.00%	Range: -300.00% to 300.00% Level 2
This parameter sets the Low Thres level for Threshold 2. For detailed information about setting up Threshold parameters, see "Thresholds" on page 58 .		
746 Timer 1 Type	Default: 0 (On Delay)	Range: n/a Level 2
This parameter defines the configuration of Timer #1 that you want the drive to emulate.		
<u>Parameter Value</u>	<u>Description</u>	
0	On Delay	
1	Off Delay	
2	On/Off Delay	
For detailed information about setting up Timer parameters, see "Timers" on page 58 .		
747 Timer 1 Signal	Default: DI-REV	Range: n/a Level 2
This parameter selects the function that the timer is counting; it includes any function listed in the digital input list. See Parameter 705 , Relay 1 Select, on page 93 for the list of options. For detailed information about setting up Timer parameters, see "Timers" on page 58 .		
748 Timer 1 Time	Default: 1.0 sec	Range: 0.0-320.0 sec Level 2
This parameter specifies the duration of time in seconds for the timer to count. For detailed information about setting up Timer parameters, see "Timers" on page 58 .		
749 Timer 2 Type	Default: 0	Range: n/a Level 2
This parameter selects the kind of timer to be used, as shown in the following options:		
<u>Parameter Value</u>	<u>Description</u>	
0	On Delay	
1	Off Delay	
2	On/Off Delay	
For detailed information about setting up Timer parameters, see "Timers" on page 58 .		

Table 7-2: Description of X5 Parameters (Page 28 of 40)

750 Timer 2 Signal	Default: DI-R/J	Range: n/a Level 2										
<p>This parameter selects the function that the timer is counting; it includes any function listed in the digital input list. See Parameter 705, Relay 1 Select, on page 93 for the list of options. For detailed information about setting up Timer parameters, see "Timers" on page 58.</p>												
751 Timer 2 Time	Default: 1.0 sec	Range: 0.0-320.0 sec Level 2										
<p>This parameter specifies the duration of time in seconds for the timer to count. For detailed information about setting up Timer parameters, see "Timers" on page 58.</p>												
794 Drive Name	Default: Drive serial number	Range: n/a Level 2										
<p>This parameter is an alphanumeric name associated with the drive. Note that files stored in a flash memory device (using parameter 799) will have a filename associated with parameter 794 (Drive Name). The complete drive serial number is composed of the data found in parameters 005 and 006, and is also found on the drive nameplate.</p>												
799 Config USB Mode	Default: Disabled	Range: n/a Level 2										
<p>This parameter allows you to select what kind of data you want to store in a flash memory device such as a thumb drive or memory stick. For more information on using a flash memory device with the X5, see page 52.</p> <table border="1"> <thead> <tr> <th><u>Option</u></th> <th><u>Description</u></th> </tr> </thead> <tbody> <tr> <td>0</td> <td>Disabled</td> </tr> <tr> <td>1</td> <td>Parameter Store to USB</td> </tr> <tr> <td>2</td> <td>Parameter Recall from USB</td> </tr> <tr> <td>3</td> <td>Keeper Dump</td> </tr> </tbody> </table>			<u>Option</u>	<u>Description</u>	0	Disabled	1	Parameter Store to USB	2	Parameter Recall from USB	3	Keeper Dump
<u>Option</u>	<u>Description</u>											
0	Disabled											
1	Parameter Store to USB											
2	Parameter Recall from USB											
3	Keeper Dump											

Table 7-2: Description of X5 Parameters (Page 29 of 40)

801 Program Number	Default: 0	Range: 0 to 9999 Level 2, Macro
This parameter (Special Program Number) provides a way of enabling hidden functions in the drive and storing parameters to the customer set.		
<u>Data Value</u>	<u>Special Function Configured</u>	
0	Standard program	
1	Reset all parameters to factory default values (display = SETP).	
2	Store customer parameter values (display = STOC).	
3	Load customer parameter values (display = SETC).	
4	Swap active parameters with customer stored settings.	
10	Reset Total Run Time, parameter 108 .	
20	Enable writing of today's time and today's date parameter.	
21	Store today's time and today's date parameter to RTC chip.	
22	Abort time writing process.	
30	Re-calibrate analog inputs (NOTE: no signal should be attached when performing this).	
40	Clear Keeper records.	
50	Allow model-dependent parameters to be recalled by USB. (See "Recalling Drive Parameters" on page 53 .)	
	Note that data value 50 must be used to recall the following parameters via USB:	
	503 V/Hz Knee Freq	514 Motor RS
	509 Rated Mtr Volt	515 Power Factor
	510 Rated Mtr FLA	517 Single Phase
	511 Rated Mtr RPM	
	Note also that the following parameters will never be recalled via USB:	
	490 Appl Macro	900 SIO Protocol
	794 Drive Name	901 SIO Baud Rate
	799 USB Config Mode	902 Comm Drop #
	810 Language	916 Infrared Baud
	811 Access Code	
80	Disable Daylight Savings Time.	
81	Enable Daylight Savings Time.	
802 Start Options	Default: LS Lockout	Range: n/a Level 2
The Start Options parameter configures the Line Start Lockout functionality of the drive. All data values ending with "2" allow you to press the Enter key to store the customer speed reference value on the keypad. You must press and hold the Enter key for two seconds to save the speed command. The following data values may be assigned:		
<u>Data Value</u>	<u>Description</u>	
LS Lockout	(Line Start Lockout). If maintained contact run operators are used, they must be opened and then re-closed for the drive to start after AC power is applied.	
AutoStart	When AC power is applied, if a Run command is present through the terminal strip, the drive will start.	
LSL w/FLY	This setting has both LS Lockout and Catch on the Fly enabled at the same time.	
Auto w/FLY	This setting has both Auto-Start and Catch on the Fly enabled at the same time.	
LS Lockout2	(Line Start Lockout). If maintained contact run operators are used, they must be opened and then re-closed for the drive to start after AC power is applied.	
AutoStart2	When AC power is applied, if a Run command is present through the terminal strip, the drive will start.	
LSL w/FLY 2	This setting has both LS Lockout and Catch on the Fly enabled at the same time.	
Auto w/FLY2	This setting has both Auto-Start and Catch on the Fly enabled at the same time.	

Table 7-2: Description of X5 Parameters (Page 30 of 40)

803 PWM Frequency	Default: 3.0 kHz	Range: 0.6-16.0 kHz Level 2
The PWM Carrier Frequency parameter sets the carrier frequency of the Pulse-Width Modulation (PWM) waveform supplied to the motor. Low carrier frequencies provide better low-end torque, but produce some audible noise from the motor. Higher carrier frequencies produce less audible noise, but cause more heating in the drive and motor.		
804 Display Mode	Default: Std Disply	Range: n/a Level 2
This parameter determines how the reference or output of the drive is displayed. If User Units is selected, parameter 805 allows you to customize the 3 unit values on the display. The following data values may be used:		
<u>Parameter Value</u> <u>Description</u>		
Std Disply	Standard commanded frequency	
Out Freq	Output frequency actually sent to the motor	
Stator Freq	Frequency of the stator	
User Units	Custom units display based on values in parameter 805	
RPM Units	Custom speed display with RPM as units	
GPM Units	Custom speed display with GPM as units	
FPM Units	Custom speed display with FPM as units	
MPM Units	Custom speed display with MPM as units	
PSI Units	Custom speed display with PSI as units	
Degrees C	Custom display with degrees C	
Degrees F	Custom display with degrees F	
Time hrs	Custom display time in hours of operation	
Time min	Custom display time in minutes of operation	
Time sec	Custom display time in seconds of operation	
Fbk RPM	Display is scaled to read in RPM based on the PID feedback input to an analog input	
Fbk PSI	Display is scaled to read in PSI based on the PID feedback input to an analog input	
Fbk GPM	Display is scaled to read in GPM based on the PID feedback input to an analog input	
Fbk User	Display is scaled to read in User units (parameter 805) based on PID feedback input to an analog input	
Vin1 User	An alphanumeric, 3-character value defined by the user.	
Vin2 User	An alphanumeric, 3-character value defined by the user.	
Cin User	An alphanumeric, 3-character value defined by the user.	
<i>With Time functions, these refer to "Retention Time." Retention time is an inverse function: as speed goes up, time goes down, and vice versa; often used in oven-type applications. The value set in parameter 809 (Display Scale) references time of operation when running at Max. Frequency. Example: if parameter 302 (Max. Frequency) is set for 60 Hz, 804 (Display Mode) is set for Time min, and 809 (Display Scale) is set for 600, the scales of the display will read 60.0 min at maximum speed and increase in time (minutes) up to the maximum scale of 6553.5 at minimum frequency.</i>		
805 Display Units	Default: RPM: 1	Range: n/a Level 2
This parameter determines the three-character customer display units used when parameter 804 is set to User Units. The last digit indicates the number of decimal places to be shown on the display. Up to three decimal places are possible.		
809 Display Scale	Default: 18000	Range: 1-32767 Level 2
This parameter determines how the reference or output of the drive will be displayed to the user. It selects the maximum scaling of the display when running at maximum frequency.		
810 Language	Default: English	Range: 1-65535 Level 2, Macro
This parameter configures the language text strings will be displayed in. The following data values may be assigned:		
<u>Parameter Value</u>		
English		
Spanish		

Table 7-2: Description of X5 Parameters (Page 31 of 40)

811 Access Code	Default: 0	Range: 0-9999 Level 2																					
<p>The security Access Code allows the user to control access to the programmable functions of the inverter. The initial value of this parameter is 0, which signifies that no access code is necessary. Any number between 1 and 9999 may be used for an access code, but is not necessary. If an access code is entered, you will not be able to view the values while scrolling through parameters. Only after the Shift key is pressed will the actual value appear.</p> <p>To enter an access code, re-program parameter 811 as you would any other parameter. After the new value is stored, you have 10 minutes of free access. If you remove power and then restore it, you will need to enter the access code to change any program parameter. If you enter an incorrect access code, the drive displays **WRONG CODE** and allows only viewing rights to the various parameters. Once the correct code is entered, you again have 10 minutes of free access unless power is removed and restored. To disable the access code requirement, set parameter 811 back to 0.</p>																							
812 Freq Ref Output	Default: 6FS	Range: n/a Level 2																					
<p>The Frequency Reference Output parameter determines the frequency pulse-train output from the DOP terminal. This digital output is a pulse train that can be linked to another drive or to a field meter for speed indication. The pulse train is a 50% duty cycle signal and requires a pull-up resistor of approximately 4.7 kOhms.</p> <p>The following data values may be assigned to this parameter:</p> <p><u>Parameter Value</u></p> <p>6FS 48FS</p>																							
813 Speed Ratio	Default: 100.0%	Range: 0.0%-200.0% Level 2																					
<p>The Master / Follower Speed Ratio parameter allows the pulse train output of one X5 series drive (master) to be used to control the speed of up to 8 other follower drives. The output of each follower can be individually programmed, or trimmed "ON-THE-FLY" with A2-RATIO. The range of adjustment is 0-200% of the master. This function only works when using the 6FS or 48FS function in parameter 204.</p>																							
814 Display Status	Default: Drive Load	Range: 0.0%-200.0% Level 2																					
<p>This parameter allows configuration of the additional parameter status field on the operate screen. The following fields can be configured:</p> <table border="1"> <thead> <tr> <th><u>Parameter Value</u></th> <th><u>Description</u></th> <th><u>Range Limit</u></th> </tr> </thead> <tbody> <tr> <td>Voltage Out</td> <td>Voltage being supplied to the motor</td> <td>Rated motor voltage</td> </tr> <tr> <td>Current Out</td> <td>Current being supplied to the motor</td> <td>200% of drive rating</td> </tr> <tr> <td>Drive Load</td> <td>Calculated percentage of drive rating</td> <td>200% of drive rating</td> </tr> <tr> <td>Drive Temp</td> <td>Calculation of total drive temp rating</td> <td>100% of unit temp rating</td> </tr> <tr> <td>Power Out</td> <td>Calculated power output of drive</td> <td>250% of drive rating</td> </tr> <tr> <td>% of FLA</td> <td>Calculated percentage of drive rating</td> <td>Percent of motor FLA</td> </tr> </tbody> </table>			<u>Parameter Value</u>	<u>Description</u>	<u>Range Limit</u>	Voltage Out	Voltage being supplied to the motor	Rated motor voltage	Current Out	Current being supplied to the motor	200% of drive rating	Drive Load	Calculated percentage of drive rating	200% of drive rating	Drive Temp	Calculation of total drive temp rating	100% of unit temp rating	Power Out	Calculated power output of drive	250% of drive rating	% of FLA	Calculated percentage of drive rating	Percent of motor FLA
<u>Parameter Value</u>	<u>Description</u>	<u>Range Limit</u>																					
Voltage Out	Voltage being supplied to the motor	Rated motor voltage																					
Current Out	Current being supplied to the motor	200% of drive rating																					
Drive Load	Calculated percentage of drive rating	200% of drive rating																					
Drive Temp	Calculation of total drive temp rating	100% of unit temp rating																					
Power Out	Calculated power output of drive	250% of drive rating																					
% of FLA	Calculated percentage of drive rating	Percent of motor FLA																					
816 Fly Catch Mode	Default: Sweep Fwd	Range: n/a Level 2																					
<p>This parameter configures how the "catch on the fly" operates.</p> <table border="1"> <thead> <tr> <th><u>Parameter Value</u></th> <th><u>Description</u></th> </tr> </thead> <tbody> <tr> <td>Sweep Fwd</td> <td>Catch on the fly algorithm sweeps through frequencies only in the forward direction while searching for the operating frequency</td> </tr> <tr> <td>Sweep Rev</td> <td>Catch on the fly algorithm sweeps through frequencies only in the reverse direction while searching for the operating frequency</td> </tr> <tr> <td>Sweep F/R</td> <td>Catch on the fly algorithm sweeps through frequencies in both directions while searching for the operating frequency. The direction that is chosen first depends on the direction of the command given to the drive. Note that this option is slower than the other two modes of operation.</td> </tr> </tbody> </table>			<u>Parameter Value</u>	<u>Description</u>	Sweep Fwd	Catch on the fly algorithm sweeps through frequencies only in the forward direction while searching for the operating frequency	Sweep Rev	Catch on the fly algorithm sweeps through frequencies only in the reverse direction while searching for the operating frequency	Sweep F/R	Catch on the fly algorithm sweeps through frequencies in both directions while searching for the operating frequency. The direction that is chosen first depends on the direction of the command given to the drive. Note that this option is slower than the other two modes of operation.													
<u>Parameter Value</u>	<u>Description</u>																						
Sweep Fwd	Catch on the fly algorithm sweeps through frequencies only in the forward direction while searching for the operating frequency																						
Sweep Rev	Catch on the fly algorithm sweeps through frequencies only in the reverse direction while searching for the operating frequency																						
Sweep F/R	Catch on the fly algorithm sweeps through frequencies in both directions while searching for the operating frequency. The direction that is chosen first depends on the direction of the command given to the drive. Note that this option is slower than the other two modes of operation.																						
819 Flt Text #1	Default: User Flt 1	Range: n/a Level 2																					
<p>This parameter defines text to be displayed for fault message #1. All ASCII options are permitted.</p>																							

Table 7-2: Description of X5 Parameters (Page 32 of 40)

825 Flt Text #2	Default: User Flt 2	Range: n/a Level 2																				
This parameter defines text to be displayed for fault message #2. All ASCII options are permitted.																						
850 PID Configure	Default: No PID	Range: n/a Level 2																				
<p>The PID Configure parameter determines what type of PID control is active in the drive.</p> <p>PID can be active at all times, or activated using a digital input. If you select a digital input as the means to enable PID control, remember to configure the parameter that sets the function of the digital input to enable PID control to complete the implementation.</p> <p>The following data values may be assigned to this parameter:</p> <table border="1"> <thead> <tr> <th><u>Parameter Value</u></th> <th><u>Description</u></th> </tr> </thead> <tbody> <tr> <td>No PID</td> <td>PID control is always inactive.</td> </tr> <tr> <td>Dir F-FWD</td> <td>Direct action with feed-forward.</td> </tr> <tr> <td>Rev F-FWD</td> <td>Reverse action with feed-forward.</td> </tr> <tr> <td>Dir F-FWD E</td> <td>Direct action with feed-forward, with PID enabled by DI.</td> </tr> <tr> <td>Rev F-FWD E</td> <td>Reverse action with feed-forward, with PID enabled by DI.</td> </tr> <tr> <td>Dir Full</td> <td>Direct action with full range.</td> </tr> <tr> <td>Rev Full</td> <td>Reverse action with full range.</td> </tr> <tr> <td>Dir Full E</td> <td>Direct action with full range, with PID enabled by DI.</td> </tr> <tr> <td>Rev Full E</td> <td>Reverse action with full range, with PID enabled by DI.</td> </tr> </tbody> </table>			<u>Parameter Value</u>	<u>Description</u>	No PID	PID control is always inactive.	Dir F-FWD	Direct action with feed-forward.	Rev F-FWD	Reverse action with feed-forward.	Dir F-FWD E	Direct action with feed-forward, with PID enabled by DI.	Rev F-FWD E	Reverse action with feed-forward, with PID enabled by DI.	Dir Full	Direct action with full range.	Rev Full	Reverse action with full range.	Dir Full E	Direct action with full range, with PID enabled by DI.	Rev Full E	Reverse action with full range, with PID enabled by DI.
<u>Parameter Value</u>	<u>Description</u>																					
No PID	PID control is always inactive.																					
Dir F-FWD	Direct action with feed-forward.																					
Rev F-FWD	Reverse action with feed-forward.																					
Dir F-FWD E	Direct action with feed-forward, with PID enabled by DI.																					
Rev F-FWD E	Reverse action with feed-forward, with PID enabled by DI.																					
Dir Full	Direct action with full range.																					
Rev Full	Reverse action with full range.																					
Dir Full E	Direct action with full range, with PID enabled by DI.																					
Rev Full E	Reverse action with full range, with PID enabled by DI.																					
851 PID Feedback	Default: Vin1	Range: n/a Level 2																				
<p>The PID Feedback parameter configures the feedback signal to be used in PID control.</p> <p>The following data values may be assigned to this parameter:</p> <table border="1"> <thead> <tr> <th><u>Parameter Value</u></th> <th><u>Description</u></th> </tr> </thead> <tbody> <tr> <td>Vin1</td> <td>Vin1 is the PID feedback.</td> </tr> <tr> <td>Cin</td> <td>Cin is the PID feedback.</td> </tr> <tr> <td>Vin2</td> <td>Vin2 is the PID feedback.</td> </tr> <tr> <td>Encoder</td> <td>The Encoder is the PID feedback.</td> </tr> </tbody> </table>			<u>Parameter Value</u>	<u>Description</u>	Vin1	Vin1 is the PID feedback.	Cin	Cin is the PID feedback.	Vin2	Vin2 is the PID feedback.	Encoder	The Encoder is the PID feedback.										
<u>Parameter Value</u>	<u>Description</u>																					
Vin1	Vin1 is the PID feedback.																					
Cin	Cin is the PID feedback.																					
Vin2	Vin2 is the PID feedback.																					
Encoder	The Encoder is the PID feedback.																					
852 PID Prop Gain	Default: 0	Range: 0-32000 Level 2																				
<p>The PID Proportional Gain parameter configures the proportional gain that is applied to the PID control.</p> <p>Note: Value must be greater than 0 for this to be active.</p>																						
853 PID Int Gain	Default: 0	Range: 0-32767 Level 2																				
<p>The PID Integral Gain parameter configures the integral gain that is applied to the PID control.</p> <p>Note: Value must be greater than 0 for this to be active.</p>																						
854 PID Feed Gain	Default: 1000	Range: 0-20000 Level 2																				
The PID Feed Gain parameter allows the feedback signal to be scaled. A setting of 1000 indicates 100.0%.																						
855 PID Error 1 856 PID Error 2	Default: Read-Only	Range: 0.00-100.00% Level 2																				
Both PID Error 1 and PID Error 2 parameters are read-only; they provide feedback on how the PID control is operating.																						
857 PID High Corr	Default: 100.00%	Range: 0.00-100.00% Level 2																				
This parameter sets the high limit of the PID output.																						

Table 7-2: Description of X5 Parameters (Page 33 of 40)

858 PID Low Corr	Default: 0.00%	Range: 0.00-100.00% Level 2
This parameter sets the low limit of the PID output.		
859 PID Deriv Gain	Default: 0.00%	Range: 0-2000 Level 2
The PID Derivative Gain parameter configures the derivative gain that is applied to the PID control. Note: Value must be greater than 0 for this to be active.		
860 PID Sleep Cfg	Default: 0	Range: n/a Level 2
This parameter configures the conditions under which the X5 can turn off (sleep) once the external process loop has been completed. Refer to parameter 861 (PID Sleep Lvl) for the sleep threshold. The following data values may be assigned to this parameter:		
<u>Parameter Value</u>	<u>Description</u>	
0	Disabled	
1	PID Fbk <	
2	PID Fbk >	
3	PID Ref <	
4	PID Ref >	
5	PID Out >	
6	PID Out <	
861 PID Sleep Lvl	Default: 0.00%	Range: 0.00-100.00% Level 2
This parameter sets the sleep level for the PID output.		
862 PID Wake-up Lvl	Default: 100.00%	Range: 0.00-100.00% Level 2
This parameter defines the band, in terms of process span, where the drive will awaken. Example: If the drive goes to sleep at 60% of the process limit (parameter 861), with this parameter set to 10% the drive will awaken at 50% of the process range.		
863 Sleep Delay Time 864 Wake-up Delay	Default: 0.0 sec	Range: 0.0 - 300.0 sec Level 2
These parameters set the sleep and wake-up delay times for the PID output.		
865 PID Feedback	Default: Read-only	Range: n/a Level 2
This is a view of the processed feedback signal after scaling (via span and offset).		
866 PID Reference	Default: Read-only	Range: n/a Level 2
This parameter sets the reference point for the PID output.		
867 PID User Units	Default: 0	Range: n/a Level 2
This parameter is for rescaling parameters 855 , 856 , 862 , and 865 in user units relative to the process rather than in percentage of full scale. The following data values may be assigned to this parameter:		
<u>Parameter Value</u>	<u>Description</u>	
0	No	
1	Yes	

Table 7-2: Description of X5 Parameters (Page 34 of 40)

880 FBus Read 1 881 FBus Read 2 882 FBus Read 3 883 FBus Read 4 884 FBus Read 5	Default: 103 Default: 104 Default: 105 Default: 107 Default: 909	Range: 0-65535 Level 2 (SIO)										
890 FBus Write 1 891 FBus Write 2 892 FBus Write 3 893 FBus Write 4 894 FBus Write 5	Default: 907 Default: 402 Default: 403 Default: 920 Default: 921											
These parameters provide access to Fieldbus communications. Default values indicate respective parameter numbers.												
900 SIO Protocol	Default: RTU N81	Range: n/a Level 2 (SIO)										
This parameter defines the protocol and the parity of the SIO port. The following data values may be assigned to this parameter:												
<table border="1"> <thead> <tr> <th>Parameter Value</th> <th>Description</th> </tr> </thead> <tbody> <tr> <td>RTU N81</td> <td>No parity, 8 data bits, 1 stop bit</td> </tr> <tr> <td>RTU N82</td> <td>No parity, 8 data bits, 2 stop bits</td> </tr> <tr> <td>RTU E81</td> <td>Even parity, 8 data bits, 1 stop bit</td> </tr> <tr> <td>RTU O81</td> <td>Odd parity, 8 data bits, 1 stop bit</td> </tr> </tbody> </table>			Parameter Value	Description	RTU N81	No parity, 8 data bits, 1 stop bit	RTU N82	No parity, 8 data bits, 2 stop bits	RTU E81	Even parity, 8 data bits, 1 stop bit	RTU O81	Odd parity, 8 data bits, 1 stop bit
Parameter Value	Description											
RTU N81	No parity, 8 data bits, 1 stop bit											
RTU N82	No parity, 8 data bits, 2 stop bits											
RTU E81	Even parity, 8 data bits, 1 stop bit											
RTU O81	Odd parity, 8 data bits, 1 stop bit											
901 SIO Baud Rate	Default: 9600	Range: n/a Level 2 (SIO)										
This parameter defines the baud rate of the SIO port. The following data values may be assigned to this parameter:												
<table border="1"> <thead> <tr> <th>Parameter Value</th> </tr> </thead> <tbody> <tr> <td>4800</td> </tr> <tr> <td>9600</td> </tr> <tr> <td>19200</td> </tr> <tr> <td>38400</td> </tr> <tr> <td>57600</td> </tr> </tbody> </table>			Parameter Value	4800	9600	19200	38400	57600				
Parameter Value												
4800												
9600												
19200												
38400												
57600												
902 Comm Drop #	Default: 1	Range: 1-247 Level 2 (SIO)										
This parameter defines the network drop number for both SIO and IRDA communications.												
903 SIO Timer	Default: 1.0 sec	Range: 0.0-60.0 sec Level 2 (SIO)										
This parameter defines a watchdog timer that will require a valid communication in the specified time period while in SIO control. If the requirement is not met, a fault occurs.												

Table 7-2: Description of X5 Parameters (Page 35 of 40)

904 SIO Cntl Word	Default: 0x0000	Range: n/a Level 2 (SIO)
--------------------------	-----------------	-----------------------------

The SIO Control Word parameter allows control of the drive through Modbus communications.

The following bits are used with this parameter:

15	14	13	12	11	10	9	8	7	6	5	4	3	2	1	0
----	----	----	----	----	----	---	---	---	---	---	---	---	---	---	---

Bit	When Set to 1 Signifies	Bit	When Set to 1 Signifies
8	Preset Input 4 (PS4)	0	SLC (Run)
9	PID Enable	1	SLF (Ref)
10	TOD Override	2	FWD
11	Cur Lim	3	REV
12	DCI	4	FEXT2
13	CTS	5	Preset Input 1 (PS1)
14	Ref Switch	6	Preset Input 2 (PS2))
15	Fault Reset	7	Preset Input 3 (PS3)

905 Ext Ref Freq 1 906 Ext Ref Freq 2	Default: 0.0 Hz	Range: Min. Freq.-Max. Freq. Level 2 (SIO)
--	-----------------	---

These parameters provide access for changing the frequency reference over the serial link.

907 Cntl Word 2	Default: 0x0000	Range: n/a Level 2 (SIO)
------------------------	-----------------	-----------------------------

This parameter allows control of the drive through Modbus communications. A "1" in the status word indicates that the output is active.

The following bits are used with this parameter:

13	12	11	10	9	8	7	6	5	4	3	2	1	0
----	----	----	----	---	---	---	---	---	---	---	---	---	---

Bit	When Set to 1 Signifies	Bit	When Set to 1 Signifies
8	Reminder Reset 1	0	R1 Output
9	Reminder Reset 2	1	R2 Output
10	Reminder Reset 3	2	DO1 Output
11	User Fault 1	3	DO2 Output
12	User Fault 2	4	RA Output
13	Serial Link I/O	5	RB Output
	(Note: Bit 13 must be set to 1 to allow SIO Config operations on analog and digital outputs	6	Alt Ramp
		7	Alt Ramp 2

908 Status Word	Default: Read-Only	Range: n/a Level 2 (SIO)
------------------------	--------------------	-----------------------------

The Status Word parameter provides status of the drive operation to a serial link user.

The following bits are used with this parameter:

15	14	13	12	11	10	9	8	7	6	5	4	3	2	1	0
----	----	----	----	----	----	---	---	---	---	---	---	---	---	---	---

Bit	When Set to 1 Signifies	Bit	When Set to 1 Signifies
8	Alt Ramp	0	SLC (Run)
9	SL Override	1	SLF (Ref)
10	Remote	2	FWD run
11	Curr Lim	3	REV run
12	DCI	4	FEXT2
13	Jogging	5	Accel
14	Zero Spd	6	Decel
15	Drive Flt	7	At Speed

Table 7-2: Description of X5 Parameters (Page 36 of 40)

909 DI Status	Default: Read-Only	Range: n/a Level 2 (SIO)																																																			
<p>This parameter provides a 15-bit status display. The following bits are used with this parameter:</p> <table border="1" style="margin-left: auto; margin-right: auto;"> <tr> <td>14</td><td>13</td><td>12</td><td>11</td><td>10</td><td>9</td><td>8</td><td>7</td><td>6</td><td>5</td><td>4</td><td>3</td><td>2</td><td>1</td><td>0</td> </tr> </table> <table style="margin-left: auto; margin-right: auto;"> <thead> <tr> <th>Bit</th><th>When Set to 1 Signifies</th><th>Bit</th><th>When Set to 1 Signifies</th><th>Bit</th><th>When Set to 1 Signifies</th></tr> </thead> <tbody> <tr> <td>10</td><td>DI-A Input</td><td>5</td><td>DI3 Input</td><td>0</td><td>FWD Input</td></tr> <tr> <td>11</td><td>DI-B Input</td><td>6</td><td>DI4 Input</td><td>1</td><td>REV Input</td></tr> <tr> <td>12</td><td>DI-C Input</td><td>7</td><td>DI5 Input</td><td>2</td><td>R/J Input</td></tr> <tr> <td>13</td><td>DI-D Input</td><td>8</td><td>MOL Input</td><td>3</td><td>DI1 Input</td></tr> <tr> <td>14</td><td>DI-E Input</td><td>9</td><td>EN Input</td><td>4</td><td>DI2 Input</td></tr> </tbody> </table>			14	13	12	11	10	9	8	7	6	5	4	3	2	1	0	Bit	When Set to 1 Signifies	Bit	When Set to 1 Signifies	Bit	When Set to 1 Signifies	10	DI-A Input	5	DI3 Input	0	FWD Input	11	DI-B Input	6	DI4 Input	1	REV Input	12	DI-C Input	7	DI5 Input	2	R/J Input	13	DI-D Input	8	MOL Input	3	DI1 Input	14	DI-E Input	9	EN Input	4	DI2 Input
14	13	12	11	10	9	8	7	6	5	4	3	2	1	0																																							
Bit	When Set to 1 Signifies	Bit	When Set to 1 Signifies	Bit	When Set to 1 Signifies																																																
10	DI-A Input	5	DI3 Input	0	FWD Input																																																
11	DI-B Input	6	DI4 Input	1	REV Input																																																
12	DI-C Input	7	DI5 Input	2	R/J Input																																																
13	DI-D Input	8	MOL Input	3	DI1 Input																																																
14	DI-E Input	9	EN Input	4	DI2 Input																																																
910 Vin1 Status 911 Cin Status 912 Vin2 Status	Default: Read-Only	Range: 0.00-100.00% Level 2 (SIO)																																																			
<p>Parameter 910 provides the input percentage applied to the Vin1 terminal; parameter 911 provides the input percentage applied to the Cin terminal; and parameter 912 provides the input percentage applied to the Vin2 terminal.</p>																																																					
913 Output Status	Default: Read-Only	Range: n/a Level 2 (SIO)																																																			
<p>This parameter provides a 10-bit binary status display. A "1" in the status word indicates that the output is active. The following bits are used with this parameter:</p> <table border="1" style="margin-left: auto; margin-right: auto;"> <tr> <td>9</td><td>8</td><td>7</td><td>6</td><td>5</td><td>4</td><td>3</td><td>2</td><td>1</td><td>0</td> </tr> </table> <table style="margin-left: auto; margin-right: auto;"> <thead> <tr> <th>Bit</th><th>When Set to 1 Signifies</th><th>Bit</th><th>When Set to 1 Signifies</th></tr> </thead> <tbody> <tr> <td>5</td><td>RB Output</td><td>0</td><td>R1 Output</td></tr> <tr> <td>6</td><td>N/A</td><td>1</td><td>R2 Output</td></tr> <tr> <td>7</td><td>N/A</td><td>2</td><td>DO1 Output</td></tr> <tr> <td>8</td><td>N/A</td><td>3</td><td>DO2 Output</td></tr> <tr> <td>9</td><td>N/A</td><td>4</td><td>RA Output</td></tr> </tbody> </table>			9	8	7	6	5	4	3	2	1	0	Bit	When Set to 1 Signifies	Bit	When Set to 1 Signifies	5	RB Output	0	R1 Output	6	N/A	1	R2 Output	7	N/A	2	DO1 Output	8	N/A	3	DO2 Output	9	N/A	4	RA Output																	
9	8	7	6	5	4	3	2	1	0																																												
Bit	When Set to 1 Signifies	Bit	When Set to 1 Signifies																																																		
5	RB Output	0	R1 Output																																																		
6	N/A	1	R2 Output																																																		
7	N/A	2	DO1 Output																																																		
8	N/A	3	DO2 Output																																																		
9	N/A	4	RA Output																																																		
914 Vmet Status 915 Imet Status	Default: Read-Only	Range: 0.00-100.00% Level 2 (SIO)																																																			
<p>Parameter 914 provides the output percentage applied to the Vmet terminal; parameter 915 provides the output percentage applied to the Imet terminal.</p>																																																					
916 Infrared Baud	Default: 9600	Range: n/a Level 2 (SIO)																																																			
<p>This parameter defines the baud rate of the IRDA port. The following data values may be assigned to this parameter: <u>Parameter Value</u> 9600 19200 38400 57600</p>																																																					

Table 7-2: Description of X5 Parameters (Page 37 of 40)

917 Fbus Port Config	Default: 485 w/ctl	Range: n/a Level 2 (SIO)
<p>This parameter is used for configuring the Fieldbus port.</p> <p>The following data values may be assigned to this parameter:</p> <p><u>Parameter Value</u></p> <p>0 = Disabled; no Fieldbus communications allowed.</p> <p>1 = 485 w/ctl: The RS485 port will be re-mapped to Fieldbus Communications.</p> <p>2 = IR w/ctl: The Infrared port will be re-mapped to Fieldbus Communications; serial link control can only come through Fieldbus communications.</p> <p>3 = IR no ctl: The Infrared port will be re-mapped to Fieldbus Communications, but no control will be allowed through Fieldbus. The RS-485 port on the drive will still have SIO control rights.</p>		
920 SIO Vmet Level	Default: 100.00%	Range: 0.00-100.00% Level 2 (SIO)
<p>This parameter allows the Vmet Analog Output level to be programmed to a certain voltage, if Vmet Config is set for SIO Config.</p>		
921 SIO Imet Level	Default: 100.00%	Range: 0.00-100.00% Level 2 (SIO)
<p>This parameter allows the Imet Analog Output level to be programmed to a certain voltage, if Imet Config is set for SIO Config.</p>		
926 Status Word 2	Default: Read-only	Range: n/a Level 2 (SIO)
<p>This parameter provides status information for the drive operation to a serial link user.</p> <p>The following data values may be assigned to this parameter:</p> <p><u>Bit # / Value</u></p> <p>0 = Reminder 1 Time Expired</p> <p>1 = Reminder 2 Time Expired</p> <p>2 = Reminder 3 Time Expired</p>		

Table 7-2: Description of X5 Parameters (Page 38 of 40)

930 Seq Cntl 1 931 Seq Cntl 2 932 Seq Cntl 3 933 Seq Cntl 4 934 Seq Cntl 5 935 Seq Cntl 6 936 Seq Cntl 7 937 Seq Cntl 8 938 Seq Cntl 9 939 Seq Cntl 10 940 Seq Cntl 11 941 Seq Cntl 12 942 Seq Cntl 13 943 Seq Cntl 14 944 Seq Cntl 15 945 Seq Cntl 16 946 Seq Cntl 17 947 Seq Cntl 18 948 Seq Cntl 19 949 Seq Cntl 20 950 Seq Cntl 21 951 Seq Cntl 22 952 Seq Cntl 23 953 Seq Cntl 24 954 Seq Cntl 25	Default: 00000 00000 00000	Range: n/a Level 2 (SEQ)
--	----------------------------	-----------------------------

These parameters each provide a 15-bit binary status display. See ["Using the X5 Program Sequencer"](#) on page 111.

The following bits are used with each of these parameters:

- Bit 0-3=Speed Selection
- Bit 4-5=Ramp Selection
- Bit 6-9=State Duration
- Bit 10-12=Control Selection
- Bit 13-15=Output Config

Table 7-2: Description of X5 Parameters (Page 39 of 40)

955 Seq Count 1 956 Seq Count 2 957 Seq Count 3 958 Seq Count 4 959 Seq Count 5 960 Seq Count 6 961 Seq Count 7 962 Seq Count 8 963 Seq Count 9 964 Seq Count 10 965 Seq Count 11 966 Seq Count 12 967 Seq Count 13 968 Seq Count 14 969 Seq Count 15 970 Seq Count 16 971 Seq Count 17 972 Seq Count 18 973 Seq Count 19 974 Seq Count 20 975 Seq Count 21 976 Seq Count 22 977 Seq Count 23 978 Seq Count 24 979 Seq Count 25	Default: 0	Range: 0-65535 Level 2 (SEQ)
These parameters configure the time, number of pulses, or analog level of sequencer steps 1 through 25, respectively. See "Using the X5 Program Sequencer" on page 111 .		
980 Seq Decision 1 981 Seq Decision 2 982 Seq Decision 3 983 Seq Decision 4 984 Seq Decision 5	Default: 00000 00000 00000	Range: n/a Level 2 (SEQ)
These parameters each provide a 15-bit binary status display. See "Using the X5 Program Sequencer" on page 111 . The following bits are used with each of these parameters: Bit 0-4=State Decision Occurs Bit 5-9=Destination State Bit 10-15=Decision Condition		
1500 Last Fault	Read-Only	Range:n/a Level: 2
This parameter, Last Fault , lists the most recent fault that occurred. For more information, refer to Chapter 8, Troubleshooting, beginning on page 125 .		
1527 9th Fault	Read-Only	Range: n/a Level: 2
This parameter, 9th Fault , lists the fault that occurred 1 before the last. For more information, refer to Chapter 8, Troubleshooting, beginning on page 125 .		
1554 8th Fault	Read-Only	Range:n/a Level: 2
This parameter, 8th Fault , lists the fault that occurred 2 before the last. For more information, refer to Chapter 8, Troubleshooting, beginning on page 125 .		
1581 7th Fault	Read-Only	Range:n/a Level: 2

Table 7-2: Description of X5 Parameters (Page 40 of 40)

<p>This parameter, 7th Fault, lists the fault that occurred 3 before the last. For more information, refer to Chapter 8, Troubleshooting, beginning on page 125.</p>		
1608 6th Fault	Read-Only	Range:n/a Level: 2
<p>This parameter, 6th Fault, lists the fault that occurred 4 before the last. For more information, refer to Chapter 8, Troubleshooting, beginning on page 125.</p>		
1635 5th Fault	Read-Only	Range: n/a Level: 2
<p>This parameter, 5th Fault, lists the fault that occurred 5 before the last. For more information, refer to Chapter 8, Troubleshooting, beginning on page 125.</p>		
1662 4th Fault	Read-Only	Range:n/a Level: 2
<p>This parameter, 4th Fault, lists the fault that occurred 6 before the last. For more information, refer to Chapter 8, Troubleshooting, beginning on page 125.</p>		
1689 3rd Fault	Read-Only	Range:n/a Level: 2
<p>This parameter, 3rd Fault, lists the fault that occurred 7 before the last. For more information, refer to Chapter 8, Troubleshooting, beginning on page 125.</p>		
1716 2nd Fault	Read-Only	Range: n/a Level: 2
<p>This parameter, 2nd Fault, lists the fault that occurred 8 before the last. For more information, refer to Chapter 8, Troubleshooting, beginning on page 125.</p>		
1743 1st Fault	Read-Only	Range:n/a Level: 2
<p>This parameter, 1st Fault, lists the fault that occurred 9 before the last. For more information, refer to Chapter 8, Troubleshooting, beginning on page 125.</p>		

7.4 Using the X5 Program Sequencer

The X5 AC drive offers functionality that allows users to program up to 25 independent operation states of the drive. This functionality is called the “program sequencer” because it allows the drive to sequence through the operation states programmed by the user. The X5 Program Sequencer can be used in applications that would normally require external intelligence, such as a simple programmable logic controller.

7.4.1 Enabling the X5 Program Sequencer

The X5 Program Sequencer can be enabled with [parameter 491 \(Seq Appl\)](#), found in the Application Macro programming mode of the X5 keypad (see [page 60](#) for more information on the macro programming mode). This parameter configures:

- Whether the sequencer is enabled,
- The time base used for all timing of the sequencer,
- Whether other sequencer parameters are visible in Level 2 programming.

Table 7-3 shows the options for this parameter:

Table 7-3: Seq Appl Parameter Options (Parameter 491)

Options	Value	Meaning
Disabled	0	The Sequencer mode of the X5 is not active and the sequencer parameters are not visible in Level 2 programming.
1 sec base	1	The Sequencer mode of the X5 is active, sequencer parameters are visible in Level 2, and all timing for the sequencer will be on a 1-second base.
.1 sec base	2	The Sequencer mode of the X5 is active, sequencer parameters are visible in Level 2, and all timing for the sequencer will be on a .1-second base.
.01 sec base	3	The Sequencer mode of the X5 is active, sequencer parameters are visible in Level 2, and all timing for the sequencer will be on a .01-second base.

7.4.2 Controlling the X5 Program Sequencer

The Program Sequencer can be activated and controlled from either the keypad or the terminal strip. It is not possible to control the sequencer through the serial link. The control method of the program sequencer is determined by [parameter 201, Input Mode](#). Setting the Input Mode parameter also allows switching from Sequencer mode to normal keypad operation by way of the Local/Remote switch. Table 7-4 illustrates possible program sequencer control configurations:

Table 7-4: Program Sequencer Control Configuration

Input Mode Setting	Input Mode Value	Local Operation	Remote Operation
Local Only	0	Sequencer control via keypad (FWD/Stop) Default Seq Ref is keypad	N/A
Remote Only	1	N/A	Seq control via FWD terminal Default Seq Ref is "Ref Select"
L/R Rem Ref	2	Normal X5 keypad operation (Sequencer disabled)	Seq control via keypad (FWD/Stop) Default Seq Ref is "Ref Select"
L/R Rem Ctl	3	Normal X5 keypad operation (Sequencer disabled)	Seq control via FWD terminal Default Seq Ref is keypad
L/R Rem Bth	4	Normal X5 keypad operation (Sequencer disabled)	Seq control via FWD terminal Default Seq Ref is "Ref Select"
EMOP	5	Sequencer not enabled	Sequencer not enabled
EMOP2	6	Sequencer not enabled	Sequencer not enabled
LOC/EMOP	7	Sequencer not enabled	Sequencer not enabled
LOC/EMOP2	8	Sequencer not enabled	Sequencer not enabled

Note: If Input Mode is configured to any of the EMOP options, the sequencer is not available.

Keypad Control (Activation) of the X5 Program Sequencer

When activating or controlling the X5 Program Sequencer from the keypad, pressing the FWD key commands the drive to cycle through the programmed states of the sequencer one time only (one-shot operation). One-shot operation will run the sequencer until state 25 is reached, or until any state that is not changed from the default is reached.

Pressing the SHIFT and FWD keys simultaneously causes the programmed sequence to repeat until the Stop key is pressed (continuous operation). In continuous mode, the sequencer runs until state 25 or any state that is not changed from the default is reached; it then jumps back to state 1.

Note that the REV key has no function in the sequencer mode.

Terminal Control of the X5 Program Sequencer

When activating or controlling the X5 Program Sequencer from terminals, continuous and one-shot operation is determined by whether the drive is wired for 2-wire or 3-wire control. If the terminal is set up for 2-wire control, the sequencer operates in continuous mode (R/J terminal inactive). This will run the sequencer until the Forward command is removed. If the terminal is set up for 3-wire control, the sequencer runs one cycle when the FWD terminal is activated.

Note that the REV terminal has very limited function in sequencer mode. It can be used to determine direction only when TERM/SIO is the control selection option.

X5 Sequencer Dwell Functionality

The X5 sequencer can dwell, or pause, in a state and disregard any command to advance to the next state. This can be done in two different ways, and both methods can be used at the same time:

- If the sequencer is actively running and you press the **Enter** key on the Operate screen of the keypad, the sequencer will dwell in the current state (it will never advance to the next state). While the sequencer is dwelling, a warning of “Seq Dwell” will flash on the Operate screen. To leave the dwell state, press the **Enter** key again from the Operate screen.
- The sequencer Dwell mode can also be entered by programming a digital input to “Seq Dwell.” The sequencer will then dwell in the current state, for as long as the digital input is active.

X5 Sequencer Advance Functionality

You can also allow the sequencer to advance to the next state without satisfying the conditions programmed to advance. To do this, program a digital input to “Seq Advance.” When a digital input program to this option changes from inactive to active, a running sequencer will advance one state. This feature is useful when debugging a sequence with long time intervals.

7.4.3 Sequencer State Configuration Overview

Each state of the program sequencer is defined by five characteristics:

- Direction in which the drive will operate
- Speed at which the drive will operate
- Ramp selection of the drive
- Output configuration (relays and digital outputs) of the drive
- How the sequencer advances to the next state.

These characteristics are configured by two parameters for each state. These parameters are named “Seq Cntl X” and “Seq Count X,” where X represents the state number of the sequencer. The “Seq Cntl X” parameter is a *hexadecimal* parameter that sets each of the characteristics listed above. “Seq Count X” sets the threshold the sequencer uses to determine when to advance by the method set in the control parameter. Bit patterns of the Seq Cntl X parameters are shown in [Figure 7-1](#).

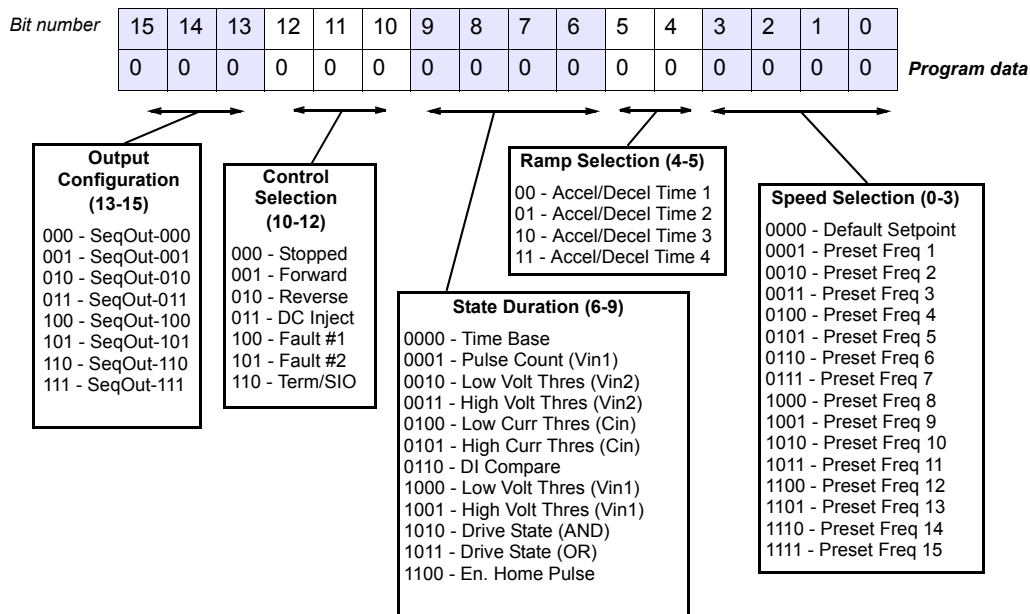

Figure 7-1: Seq Cntl Parameter, Bit Definition

X5 Sequencer Speed Selection

Table 7-5 gives more information on the speed selection options available in the X5 sequencer by programming bits 0, 1, 2, and 3 of each state's control parameter. The options include any Preset Speed, Max Frequency, or allowing the reference to be determined in the normal X5 control path.

Table 7-5: Speed Selection Options

Binary Value (refers to bits 0-3)	Definition (Resultant Speed)
0000	Speed selection as in normal X5 operation, as defined by parameters 204 (Ref Select) and 201 (Input Mode).
0001	Value of parameter Preset Freq 1 (303)
0010	Value of parameter Preset Freq 2 (304)
0011	Value of parameter Preset Freq 3 (305)
0100	Value of parameter Preset Freq 4 (306)
0101	Value of parameter Preset Freq 5 (307)
0110	Value of parameter Preset Freq 6 (308)
0111	Value of parameter Preset Freq 7 (310)
1000	Value of parameter Preset Freq 8 (311)
1001	Value of parameter Preset Freq 9 (312)
1010	Value of parameter Preset Freq 10 (313)
1011	Value of parameter Preset Freq 11 (314)
1100	Value of parameter Preset Freq 12 (315)
1101	Value of parameter Preset Freq 13 (316)
1110	Value of parameter Preset Freq 14 (317)
1111	Value of parameter Preset Freq 15 (318)

X5 Sequencer Ramping Selection

When the sequencer is active, the active ramp is no longer determined by parameter "Ramp Select." The user, however, does have the choice of using the main ramps (Accel Time 1/Decel Time1), or the alternate ramp sets (Accel Time 2/Decel Time 2...3, 4) for each independent state. This is determined by bits 4 and 5 of the step's control parameter. The following chart shows the selection of ramp times based on how bits 4 and 5 are set for the control parameter:

Table 7-6: Ramp Selection Options

Binary Value (refers to bits 4-5)	Definition (Resultant Speed)
00	Accel Time 1 and Decel Time 1 will be the ramp times for this step.
01	Accel Time 2 and Decel Time 2 will be the ramp times for this step.
10	Accel Time 3 and Decel Time 3 will be the ramp times for this step.
11	Accel Time 4 and Decel Time 4 will be the ramp times for this step.

Sequencer Output Configuration

The X5 Program Sequencer allows digital outputs to be activated during states of the sequencer. This function could be used to activate other devices in a system or to signal to an operator when a part of the sequence is active. The user sets the digital output by setting bits 13-15 of the control parameter with a binary value, and then sets a digital output parameter with the option for that same binary value. For example, if a control state was output configured for a binary value of 111, then any digital output configured to “SeqOut-111” would be activated during that time. The following chart shows the output configuration options for the X5 drive:

Table 7-7: Output Selection Options

Binary Value (refers to bits 13-15)	Definition (Output Configuration)
000	Any digital output (or relay output) configured for SeqOut-000 is active in this state.
001	Any digital output (or relay output) configured for SeqOut-001 is active in this state.
010	Any digital output (or relay output) configured for SeqOut-010 is active in this state.
011	Any digital output (or relay output) configured for SeqOut-011 is active in this state.
100	Any digital output (or relay output) configured for SeqOut-100 is active in this state.
101	Any digital output (or relay output) configured for SeqOut-101 is active in this state.
110	Any digital output (or relay output) configured for SeqOut-110 is active in this state.
111	Any digital output (or relay output) configured for SeqOut-111 is active in this state.

X5 Sequencer Control Selection

The X5 Program Sequencer allows several control selection options not available in the X4 Program Sequencer. These new options allow a terminal strip control state, or a state that faults the drive. Bits 10-12 of the state's control parameter determine the control selection configuration for that state of the sequence. See the following chart for control selection options:

Table 7-8: Control Selection Options

Binary Value (refers to bits 10-12)	Definition
000	The drive will be stopped while in a state configured with this control selection.
001	The drive will be running FWD while in a state configured with this control selection.
010	The drive will be running REV when configured with this control selection.
011	The drive will be injecting DC current when configured with this control selection.
100	The drive will be faulted with User Fault #1 when configured with this control selection.
101	The drive will be faulted with User Fault #2 when configured with this control selection.
110	The drive will be in control of a terminal strip digital input configuration or an SIO control word configuration. In this state, any digital input configured to “Seq Fwd” will control the drive through the terminals with two-wire control. If bit 0 is enabled in SIO Control Word, then bits 2 and 3 determine if the drive is running forward, reverse, or is stopped.
111	Future use (drive will be stopped)

Sequencer State Duration

Bits 6-9 of each sequencer control parameter specify how that step will allow advancement to the next step. The options for advancement are **time**, **pulse input**, **voltage threshold**, **current threshold**, **pulse threshold**, **drive state**, or **digital input comparison**. After the advancement method is selected with these bits, the threshold of advancement is determined by the state's count parameter (see the next paragraph).

Sequencer State Advance Threshold (via Count Parameter)

The sequencer count parameters work in conjunction with the state duration configuration in the control parameter to determine when to advance to the next state. The function of this parameter is dependent on the state duration configuration as defined in [Table 7-9 on page 117](#). This advance can only jump to the next numerical state of the sequencer. For conditional jump destinations, see [“Sequencer Decision Configuration” on page 120](#). The range of data programmed into this parameter can be from 0 to 65,535, and can represent time, pulse counts, analog voltage thresholds, analog current thresholds, or digital comparison values.

Table 7-9: Seq Count Definition Based on Cntl Parameter Configuration (Page 1 of 2)

Bits 6-9 of Seq Cntl	Description of Seq Count Function		
0000	Time Base - The active sequencer state will last for a time interval equal to the number “Seq Count X” multiplied by the time base configured in the Seq Appl parameter.		
	Seq Appl Setting	Time to Advance	Maximum Sequence Time
	1 sec Base	(1 sec) * (Seq Count X)	18.2 hours
	.1 sec Base	(0.1 sec) * (Seq Count X)	1.82 hours
0.1 sec Base	(0.01 sec) * (Seq Count X)	10.92 minutes	
0001	Pulse Count - The active sequencer state will last until the number of pulses programmed into “Seq Count X” is detected on terminal Vin1.		
0010	Low Analog Voltage Threshold - The active sequencer state lasts until the voltage signal applied to terminal Vin2 is less than a value programmed in “Seq Count X.” The value programmed in “Seq Count X” should be the percentage of input after span and offset are applied (where 100.00% = 10000). Note: The % of analog input after span and offset can be read in parameter 912, Vin2 Status .		
0011	High Analog Voltage Threshold - The active sequencer state lasts until the voltage signal applied to terminal Vin2 is > a value programmed into “Seq Count X.” The value programmed into “Seq Count X” should be the percentage of input after span and offset are applied (where 100.00% = 10000). Note: The % of analog input after span and offset can be read in parameter 912, Vin2 Status .		
0111	Low Analog Current Input - The active sequencer state lasts until the current signal applied to terminal Vin2 is < a value programmed in “Seq Count X.” The value programmed in “Seq Count X” should be the percentage of input after span and offset are applied (where 100.00% = 10000). Note: The % of analog input after span and offset can be read in parameter 911, Cin Status .		
0101	High Analog Current Input - The active sequencer state lasts until the current signal applied to terminal Vin2 is > a value programmed into “Seq Count X.” The value programmed into “Seq Count X” should be the percentage of input after span and offset are applied (where 100.00% = 10000). Note: The % of analog input after span and offset can be read in parameter 911, Cin Status .		
1000	Low Analog Voltage Threshold (Vin1) - The active sequencer state lasts until the voltage signal applied to terminal Vin1 is < a value programmed in “Seq Count X.” The value programmed in “Seq Count X” should be the percentage of input after span and offset are applied (where 100.00% = 10000). Note: The % of analog input after span and offset can be read in parameter 910, Vin1 Status .		

Table 7-9: Seq Count Definition Based on Cntl Parameter Configuration (Page 2 of 2)

Bits 6-9 of Seq Cntl	Description of Seq Count Function
1001	High Analog Voltage Threshold (Vin1) - The active sequencer state lasts until the voltage signal applied to terminal Vin1 is > a value programmed in "Seq Count X." The value programmed in "Seq Count X" should be the percentage of input after span and offset are applied (where 100.00% = 10000). Note: The % of analog input after span and offset can be read in parameter 910, Vin1 Status .
1010	Drive State (AND) - With this selection, the count parameter represents a bit-packed status word corresponding to drive state conditions. The format of this status word is documented in " Advancement on Drive State Conditions " on page 119. The Sequencer will advance if all of the drive conditions are met that are enabled in the count parameter.
1011	Drive State (OR) - With this selection, the count parameter represents a bit-packed status word corresponding to drive state conditions. The format of this status word is documented in " Advancement on Drive State Conditions " on page 119. The Sequencer will advance if any of the drive conditions are met that are enabled in the count parameter.
1100	Encoder Home Pulse - The active sequencer state lasts until the no. of pulses programmed into "Seq Count X" is detected on Encoder Home Input C+, C-. This allows advancement on process revolutions.
0111 1101 1110 1111	The sequencer will never advance if these options are selected.

7.4.4 Advancement on Drive State Conditions

Figure 7-2 shows how the Seq Count parameter is bit-packed with drive state conditions when the state duration bits are programmed to 1010 and 1011. If the AND (1010) configuration is selected, then **all** bits set in the count parameter must have the corresponding drive state occur for advancement to the next state. If the OR (1011) configuration is selected, then **any** bits in the count parameter must have the corresponding drive state occur for advancement to the next step.

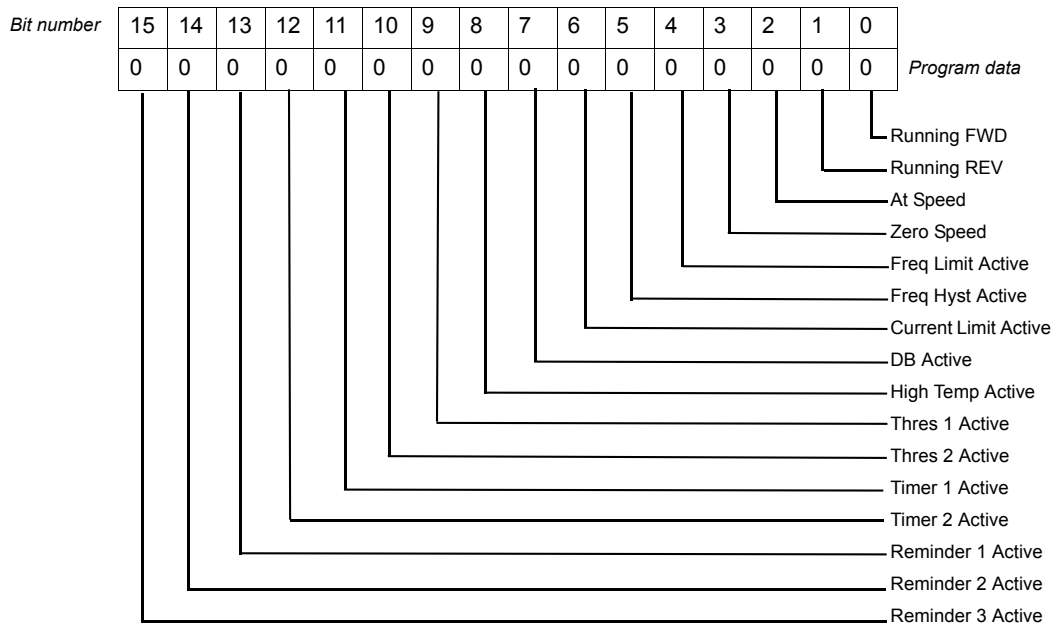

Figure 7-2: Seq Count Parameter's Drive State Bit-Packed Definition

7.4.5 Sequencer Decision Configuration

The X5 sequencer has up to five possible decision states available. This allows users to program a decision into the sequence. Decisions are programmed through five parameters: **Seq Decision 1**, **Seq Decision 2**, **Seq Decision 3**, **Seq Decision 4**, and **Seq Decision 5**. These parameters are a bit-packed configuration that allows a decision to be programmed into any step. The format of this parameter is shown in [Figure 7-3](#):

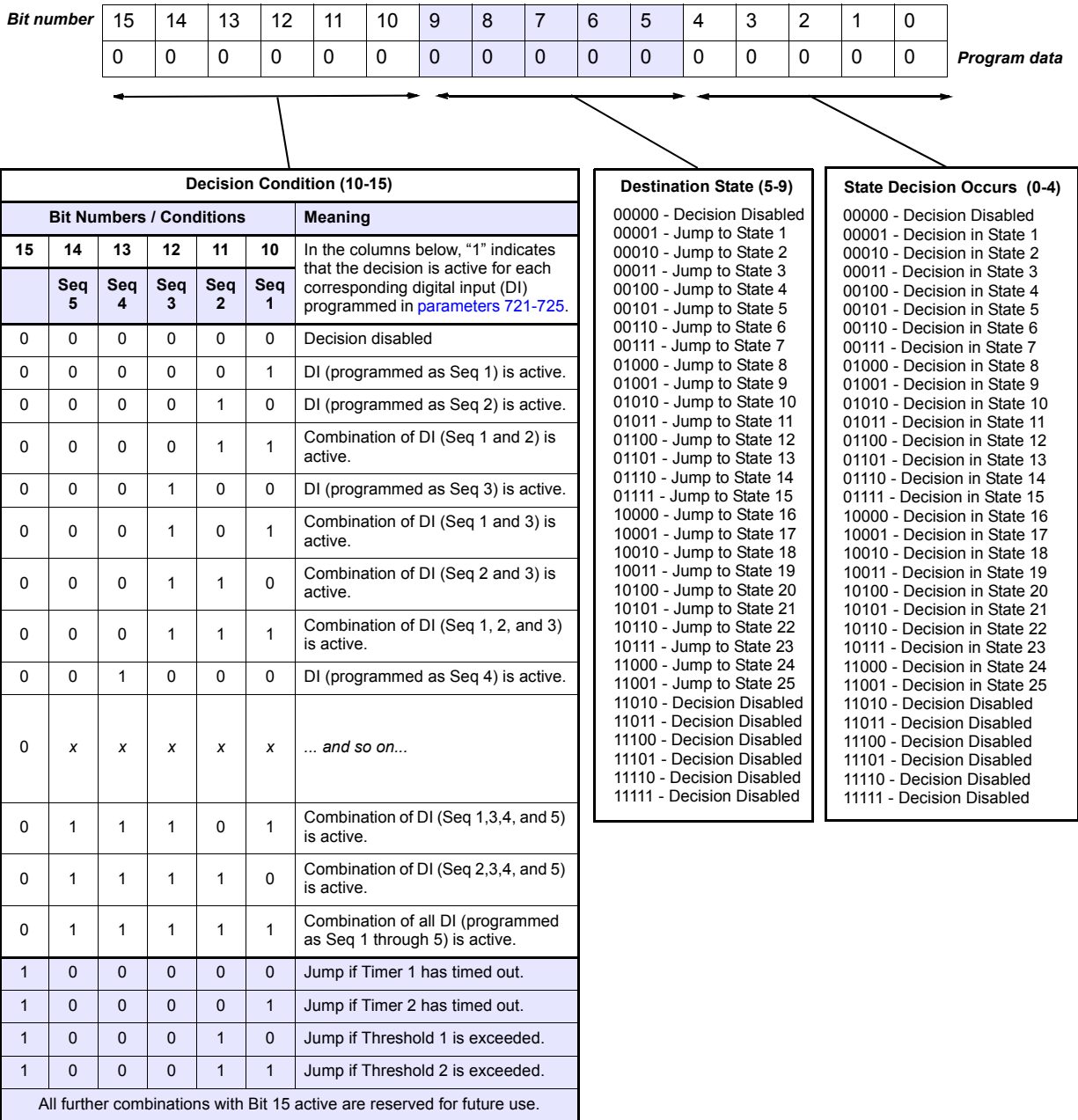
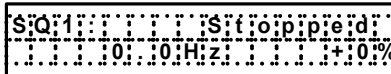

Figure 7-3: Seq Decision Parameter's Bit-Packed Definition

7.4.6 Sequencer Status Indicators

When the sequencer is enabled, the control path indication field on the keypad will indicate SQx, where x represents the active state of the sequencer. A sample operate screen (where the sequencer is in state 1) is shown below:



When the sequencer is running, a warning, “Seq Running,” will flash on the screen to indicate that the drive control state may change without user input. For example:

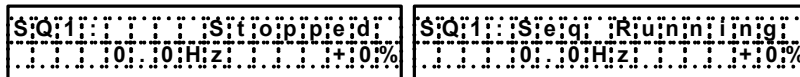

When the sequencer is dwelling (pausing) in a state, a warning, “Seq Dwell,” will flash on the screen to indicate that the sequencer will not advance. For example:

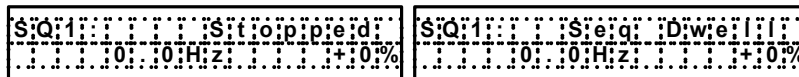

7.4.7 Sample Sequencer Program

A machine is required to run in the forward direction at 50 Hz for one hour, then quickly decelerate to a stop. While stopped, a digital output must be enabled to sound an alarm to an operator. After two minutes, the machine must accelerate in the reverse direction to 5 Hz until a limit switch is activated, causing the drive to decelerate to a stop. The following three sequential states can be programmed using only the drive:

Table 7-10: Sample Sequencer Program Requirements

	State 1	State 2	State 3
Direction Selection	Forward	Stop	Reverse
Speed Selection	50 Hz	Zero speed	5 Hz
Ramp Selection	Primary	Alternate	Primary
Output Configuration	SeqOut-00	SeqOut-01	SeqOut-10
State Duration	1 hour	2 minutes	Until DI active

First, since two of the sequential states are time-based, the proper setting of the “Seq Appl” parameter must be determined. Since there is not time required that has resolution needed of less than one second, the “1 sec Base” option is the easiest to use. If greater resolution is needed (for example, if a state needed to last for 2.5 seconds), another option should be chosen.

As the sequence needs a digital input and a digital output, two non-sequencer parameters must be used. Set parameter “DI1 Configure” to “Seq1” and parameter “DO1 Configure” to “SeqOut-01.”

Since control of the sequencer is only needed from the keypad, the configuration of the “Input Mode” parameter should be “Local Only.”

Required parameter modifications for this program are given in Table 7-11, with brief explanations.

Table 7-11: Required Parameter Settings for Sample Sequencer Program

Parameter	Value	Explanation
Seq Appl	“1 sec Base”	Sets 1 second time increments
DI1 Configure	“Seq1”	Allows DI1 to end state 3
DO1 Configure	“SeqOut-01”	Allows DO1 to be active in state 2
Preset Speed 1	5 Hz	Speed for state 3
Preset Speed 6	50 Hz	Speed for state 1
Seq Cntl1*	00010000110	No outputs/FWD/Timed/Primary Ramp/Preset Speed 6
Seq Count 1	0000010000000110	1 hour = 3600 seconds
Seq Cntl 2*	01000001000	Enable Output/Stop/Timed/Alt Ramp/Speed Ignored
Seq Count 2	0010000000010000	2 minutes = 120 seconds
Seq Cntl 3*	00101100001	No outputs/REV/DI Value/Primary Ramp/Preset Speed 1
Seq Count 3	0100100110000001	Seq1 active

* These digital codes must be converted to hexadecimal equivalents for entry into the drive.

Machine Number _____

Step	Output Configuration			Direction Selection			State Duration			Ramp Selection			Speed Selection			Hex Value See App. A, page 132
14																
15																
16																
17																
18																
19																
20																
21																
22																
23																
24																
25																
Notes:																

Chapter 8: Troubleshooting

8.1 X5 Fault Codes

When faults occur, you can access the status parameters that are saved along with the fault (Advanced Fault history). To view these parameters, which store the drive's status at the time of the fault, access **Fault History** by pressing **SHIFT** and **ENTER**, and select **Last Fault**. Press the **Shift** key while viewing the last fault, and then use the **INC** or **DEC** (up or down arrow) keys to scroll through the stored drive status parameters. Press the **Shift** key again to return to the programming mode fault parameter.

A great deal of information is contained in the Fault History log for the last fault, and also the previous nine faults, including the following:

Output Frequency	Total Run Time	DI Status	Drive Status 2
Drive Load	DC Bus Voltage	Output Status	
Drive Status	Adv Fault Code	Vin1 Status	
Drive Warning	Cntl Board Temp	Cin Status	
Output Voltage	Drive Power Out	Vin2 Status	
Output Current	Fault Date	Vmet Status	
Load Torque	Fault Time	Imet Status	
Drive Temp	Drive Warning 2	Actual Carrier	

For questions about accessing fault codes, and for advanced troubleshooting problems, please contact us (web site: <http://www.vacon.com> or by phone (+1 877-822-6606, worldwide; or from the United States at 717-267-2522).

Table 8-1 shows the fault codes that may be displayed during X5 AC drive operation, along with suggestions for recovering from the fault condition.

Table 8-1: X5 Fault Codes (Page 1 of 6)

Code	Fault Display	Description	Adv. Fault Code	Explanation	Suggestions for Recovery
1	System	System fault	0,1,2	Internal microprocessor problem	Consult factory for repair or replacement.
			3	Thermistor profile incorrect	Consult factory for repair or replacement.
2	EE Checksum	Checksum error	0	Memory problem when reflashing the drive's memory	<ul style="list-style-type: none"> Reset drive to factory settings. Consult factory.
			1,2,3	Conflict in drive's memory	<ul style="list-style-type: none"> Reset drive to factory settings. Consult factory.
			4	Unable to write an EE parameter after a parameter has been changed through the keypad or SIO	<ul style="list-style-type: none"> Reset drive to factory settings. Consult factory.
			5	The drive is receiving EE write requests faster than they can be processed. This would typically be caused by writing parameters too frequently through Modbus.	Slow down the frequency of Modbus writes.

Note: Shaded faults are auto-resettable, except where noted.

Table 8-1: X5 Fault Codes (Page 2 of 6)

Code	Fault Display	Description	Adv. Fault Code	Explanation	Suggestions for Recovery
3	Curr Calibr	Current calibration fault	0	Current calibration fault on phase T1/U	<ul style="list-style-type: none"> Check the motor connections to the terminal strip of the drive and at the motor. Have motor checked. Consult factory for repair or replacement of drive.
			1	Current calibration fault on phase T3/W	
			2	Current calibration fault on phase T2/V	
4	Power Supp	Power supply fault	0	5V supply is below 4 Vdc for more than 100 ms	<ul style="list-style-type: none"> Increase resistance between REF and analog inputs. Check wiring to REF terminals. Consult factory.
6	IOC Trip	Instantaneous overcurrent trip	0	Short circuit was detected on power-up	<ul style="list-style-type: none"> Remove the short from the power wiring Check for shorted motor Consult factory.
			1	Short circuit was detected during operation	
7	MOL	MOL contact fault	0	The MOL digital input was activated, depending on pull-up or pull-down logic configuration	Reset MOL contact or remove condition causing the MOL contact activation.
8	Model ID	ID # out of range	0,1,2	Control board is not reading the drive ID properly	Consult factory for repair or replacement.
10	Res Lockout	Restart lockout	0	The number of fault restarts is greater than the limit defined in the customer parameter.	Check the actual fault in the fault log and use the appropriate remedy.
11	Ground	Ground fault	0	The drive has detected current imbalance between output phases. Imbalance determined to be current flow to ground.	<ul style="list-style-type: none"> Check for unbalanced currents. Check for grounded motor leads or motor. Consult factory.
12	Vac Imblnce	Input voltage imbalance	0	The drive has detected a single-phase condition or a voltage imbalance outside the drive's rating while running a load that could be damaging to the drive.	Check input voltage and current for imbalance, and correct.
13	OverVoltage	Overvoltage condition	0	The drive has detected an overvoltage condition during power-up (<i>not auto-resettable</i>).	Verify incoming line power is within specification. Add reactor or transformer to correct.
			1,3	The drive has detected an overvoltage condition during a running condition.	Verify incoming line power and check for regenerative load. Reduce Regen load or add dynamic braking resistors. Regen Current Limit may help; consult factory.
			2	The drive has detected an overvoltage condition on power-up on the load side.	Verify incoming line power is within specification. Add reactor or transformer to correct.

Note: Shaded faults are auto-resettable, except where noted.

Table 8-1: X5 Fault Codes (Page 3 of 6)

Code	Fault Display	Description	Adv. Fault Code	Explanation	Suggestions for Recovery
15	Dyn Brake	Dynamic brake overload	0	• The DB circuit is active on power-up (<i>not auto-resettable</i>)	Check for failed braking transistor. Consult factory.
			1	• The DB circuit is being activated for too long, possibly causing the resistor to overheat or fail.	Reduce braking cycle or increase capacity. Activate current limit; consult factory.
			2	• The DB circuit is overloaded because of too large a regenerative load.	Reduce braking cycle or increase capacity. Activate current limit; consult factory.
			3,4,5	• The DB circuit is faulty on power-up (<i>not auto-resettable</i>).	
18	OverCurrent	Overcurrent condition	0	• The drive sensed an overcurrent condition on power-up (<i>not auto-resettable</i>).	Check for failed output power device or shorted motor.
			1	• The drive sensed an overcurrent condition during operation. The current has exceeded the safe operation point of power devices.	Reduce load on motor. Verify that Motor FLA is programmed correctly. Check for mechanical binding and shock loading.
19	Over Temp	Over- temperature condition	0	• The temperature of the heatsink exceeded a temperature limit.	Check that ambient temperature does not exceed drive's rating. Check for fan operation (assuming drive has fans installed).
			1	• The temperature of the control board exceeded a temperature limit.	Check that ambient temperature does not exceed drive's rating. Check for fan operation (assuming drive has fans installed).
			2	• The drive sensed the heatsink thermistor sensor is faulty or not connected properly.	Check thermistor connections or replace. Consult factory.
			3	• The drive sensed the control board thermistor sensor is faulty or not connected properly.	Check thermistor connections or replace. Consult factory.
20	Motor TOL	Motor timed overload trip	0	The drive detected an overload that exceeds the customer's defined overload setting.	Check load current demand. Verify Motor FLA is programmed to the correct value. Verify TOL characteristic is correct for the application.
21	Low Temp	Low temperature	0	This fault occurs if the temperature of the heatsink falls below -10.0 degrees C.	Verify that ambient temperature is within the drive's specifications; increase the ambient temperature if necessary.
22	Ref Loss	Speed reference loss	0	The drive detected the analog input was configured to fault if the input current went below the level specified by customer parameters.	Check physical connections for reference signal. Check that programming for 4-20 mA signal is correct. Verify that signal to the drive is correct.

Note: Shaded faults are auto-resettable, except where noted.

Table 8-1: X5 Fault Codes (Page 4 of 6)

Code	Fault Display	Description	Adv. Fault Code	Explanation	Suggestions for Recovery
23	Brk Wire	Broken wire detection	0	The drive detected that the potentiometer circuit wiring opened and generated a fault.	Check wiring for loss of connection to control terminals. Check that a proper-value potentiometer is installed.
24	Keypad Loss	Keypad loss	0	This fault occurs because of a problem with the keypad or a keypad connection. It occurs if the drive detects that it cannot read any key presses.	Check the connection from keypad to control board. Note that the keypad is not designed for remote mounting without the use of an X5 Remote Keypad option. See "Chapter 9: X5 Options" on page 131 for more information.
			1	This fault occurs because of a problem with the keypad, a keypad connection, or the wrong keypad is being used. It occurs if the keypad ID for an X5 cannot be read.	
			2	This fault occurs because of a problem with the keypad or a keypad connection. It occurs if the drive detects that it cannot write to the LCD.	
25	Comm Loss	Communication loss	0	This fault occurs when the drive is in a serial link control path and the amount of time since the last Modbus comm. exceeds the time set in parameter 903 (SIO Timer) .	Check connections to the Modbus port. Adjust value of parameter 903 (SIO Timer) as needed.
26	Regen Time	Regen timeout	0	This fault occurs if the drive takes more time to decelerate to a stop than is allowed. The timeout is determined by the longest deceleration ramp time (Decel1 or Decel2) plus the Regen Timeout parameter.	Reduce the amount of regenerative energy or increase the Regen timeout parameter.
27	Pwr Bridge	Power bridge fault	0,1,2	The drive detected a failure in the output power devices.	Check for failed input power device.
28	Drive TOL	Drive timed overload	0	The drive sensed an overload that exceeded the drive rating.	Check that load conditions do not exceed the drive's rating (120% for 60 seconds from nameplate current rating for normal duty and 150% or rated current for 60 seconds heavy duty).
29	Stuck Key	Stuck key error	0	This fault occurs if a key press is detected upon power-up. This would occur because of a defective keypad or because someone was holding down a key when powering-up the drive.	Check for stuck keypad and repair or replace. Consult factory.
30	Param Range	Parameter out of range	0	One of the customer parameters is out of range.	Check for a parameter value saved out of the standard range. Reset parameters to factory default. Consult factory.

Note: Shaded faults are auto-resettable, except where noted.

Table 8-1: X5 Fault Codes (Page 5 of 6)

Code	Fault Display	Description	Adv. Fault Code	Explanation	Suggestions for Recovery
31	Pwr Wiring	Power wiring error	0	This fault flags a problem with the drive wiring.	Check that input power wiring is not connected to load power terminals. Consult factory.
			1	This fault can occur if an IOC fault is detected during the power wiring test.	
32	Low Voltage (Undervoltage)	Low voltage trip	0	This fault occurs if a power dip is detected when the drive is operating, and the drive is not able to ride through the power dip before shutting off outputs.	Verify that input line power is within the drive's specifications. Add a transformer or reduce demands to power feed. Consult factory.
			1	This fault occurs when an undervoltage condition (power-down) is detected, and when parameter 501 is set for Vector or Linear Auto mode, with "Coast Stop" assigned as the parameter value. In undervoltage conditions, the drive coasts to a stop, and generates an undervoltage fault.	
			2	This fault occurs when an undervoltage condition (power-down) is detected, and when parameter 501 is set for Vector or Linear Auto mode, with "Controlled" assigned as the parameter value. In undervoltage conditions, the drive decelerates the motor. If power is restored, the drive accelerates to the command frequency without faulting; if the drive stops, it generates an undervoltage fault.	
33	1Ph Overload	1Ph overload	0	If the user configures parameter 517 (Single Phase) for single-phase operation, this fault occurs if the bus voltage ripple is outside the limit of the drive.	Check that input power demand does not exceed the drive's capacity for single-phase operation. Consult factory.
34	RS Meas. Fail	Stator resistance measurement failed	0	If the drive cannot measure the stator resistance properly, this fault occurs.	Try the routine again and if the fault occurs twice, consult the factory.
35	User Flt 1	User-defined fault #1	0	User-defined	Consult factory if assistance is needed.
36	User Flt 2	User-defined fault #2	0	User-defined	Consult factory if assistance is needed.
37	Encoder Flt	Fault in encoder	0	Encoder overspeed fault.	Check parameters for proper configuration.
			1	The encoder has improper setup.	Try setting up the encoder again; consult factory for assistance if needed.
			2 or 3	The encoder is not functioning properly.	Consult factory.

Note: Shaded faults are auto-resettable, except where noted.

Table 8-1: X5 Fault Codes (Page 6 of 6)

Code	Fault Display	Description	Adv. Fault Code	Explanation	Suggestions for Recovery
38	OP BRD Fit	Fault on options board	0	Loss of communication between option board and drive.	Check connections. Consult factory.
			1	Could not identify option board	Consult factory.
			2	The option board does not match the last option board ID that was active when the drive was powered down.	Check and reconfigure option board setup.
			3	Option board ID is unsupported.	Consult factory.
			4	Comm option board does not have the proper daughter card installed.	Consult factory.
			5	Internal problem.	Consult factory.
			6	Network communications error.	Check connections and setup.
			7	Option board has been removed.	Reconfigure.
39	Fan Loss	Loss of fan control or operation	0	There is a problem with the heat sink fan.	Consult factory.
			1	There is a problem with the internal fan. This occurs only on Size 4 and 5 models. All other models display a fan error warning. Note that this is lack of fan control, so the fan can be spinning and this fault will still occur. This can happen if the fan is on and should not be, or if the fan feedback signals are obstructed from getting to the control board.	

Note: Shaded faults are auto-resettable, except where noted.

Chapter 9: X5 Options

PDA-trAC[®] Plus For Pocket PC

The wireless optical interface on the **X5** allows data transfer for X5 AC Drive settings, using the PDA-trAC Plus to upload, download, edit, and save drive parameters easily and conveniently. This software can be downloaded from our web site at www.vacon.com, or contact your sales representative.

WIN-trAC[®] and WIN-trAC PRO[®] Drive Supervisor

This Windows[®]-based software program provides a simple and unique way to configure, monitor, diagnose, control, and manage drive applications. **WIN-trAC**, for single-drive, point-to-point applications, is provided free with the SIOC03 adapter for drives. **WIN-trAC PRO**, configured for multi-drive applications, must be registered for use.

Options for Serial Communications and 115 Vac Interface

Part Numbers: **X5DNET01**, **X5EIP01**, **X5MBTCP01**, **X5OPT01**

The first three options allow the **X5** to communicate on powerful serial communication networks like DeviceNet, Ethernet IP, and Modbus TCP/IP. The fourth option allows you to connect a shaft-mounted optical encoder to the X5 for improved performance. All include five channels of 115 Vac control options.

Remote Keypad for X5 (when used as a panel-mounted drive (Size 0-2))

Part Number: **XRKPM**

This Remote Keypad kit can be used when a Size 0, 1, or 2 **X5** model is mounted inside a host enclosure, and when programming and operation need to be done on the front of the enclosure. The kit comes with a keypad and adapter assembly that replaces the standard keypad on the drive. The original keypad assembly is removed and discarded, or can be kept as a spare for other X5 models not using the XRKPM option. The option includes a standard 12-foot ribbon cable. When installed properly, the remote keypad meets NEMA 4x/IP66 standards and the drive rating will be IP20.

Remote Keypad for X5 (when used as a wall-mounted drive (Size 0-2))

Part Number: **XRKWM**

This Remote Keypad kit can be used when a Size 0, 1, or 2 **X5** model is mounted in a stand-alone configuration, and when programming and operation need to be done in another location. The kit comes with a keypad and adapter assembly that replaces the standard keypad on the drive. The remote keypad can be mounted up to 100 feet from the drive, and requires a 15-conductor shielded cable to be supplied by the user. When installed properly, both the remote keypad and drive meet NEMA 4x/IP66 standards.

Remote Keypad Mounting Kit for X5 (Sizes 3 through 5)

Part Number: **XRKMK**

This Remote Keypad kit can be used with a Size 3, 4, or 5 **X5** model to allow the keypad to be mounted in another location. The kit comes with an adapter assembly to allow the existing keypad to be remotely mounted. The remote keypad can be mounted up to 100 feet from the drive, and requires a 15-conductor shielded cable to be supplied by the user. When installed properly, both the remote keypad and drive will meet the unit's core enclosure standards, either NEMA 4x/IP66, or NEMA 12/IP55.

Appendix A: Parameter 201 Options

The following table shows how parameter **201** (Input Mode) options function in local or remote mode.

Parameter 201 Option	Local		Remote	
	Speed Control	Start/Stop Control	Speed Control	Start/Stop Control
Local Only	Keypad	Keypad	None	None
Remote Only	None	None	Speed potentiometer, terminal strip signals	Terminal strip switch network
L/R Rem Ctl	Keypad	Keypad	Keypad	Terminal strip switch network
L/R Rem Ref	Keypad	Keypad	Speed potentiometer, terminal strip signals	Keypad
L/R Rem Bth	Keypad	Keypad	Speed potentiometer, terminal strip signals	Terminal strip switch network
EMOP_EMOP2	None	None	Terminal strip momentary pushbuttons	Terminal strip switch network
LOC / EMOP_EMOP2	Keypad	Keypad	Terminal strip momentary pushbuttons	Terminal strip switch network

Appendix B: Binary-Hexadecimal Conversion

The X5 AC drive utilizes hexadecimal numbers to display and store the binary values of some parameters. These parameters are read and written as four-digit hexadecimal values.

The following table shows the binary values that correspond to the sixteen hexadecimal values. The binary values are divided into four columns so you may more readily see which bits of the status or control words are affected by the binary values.

Binary Value				Hexadecimal Value
0	0	0	0	0
0	0	0	1	1
0	0	1	0	2
0	0	1	1	3
0	1	0	0	4
0	1	0	1	5
0	1	1	0	6
0	1	1	1	7
1	0	0	0	8
1	0	0	1	9
1	0	1	0	A
1	0	1	1	B
1	1	0	0	C
1	1	0	1	D
1	1	1	0	E
1	1	1	1	F
15	14	13	12	
11	10	9	8	
7	6	5	4	
3	2	1	0	
<i>Corresponding Bit Positions of Parameter Words</i>				



EU Declaration of Conformity

WE: Vacon, Inc.
3181 Black Gap Road
Chambersburg, PA 17202 USA

hereby declare that the products:

Product Name: Vacon X Series AC Drives;

Model Designation: Vacon X4CxxxxxC(or D) and X5CxxxxxC(or D) and X5CxxxxxC09

have been designed and manufactured in accordance with standards:

Low Voltage Directive:	EN50178 Electronic equipment for use in power installations
Electromagnetic compatibility:	The models listed above do not include internal EMC filters and external equipment must be used to achieve EN61800-3 compliance. Units in the 380-460V range (as denoted with a 1 suffix, e.g. XxC4xxxxC1) include internal EMC filters, and fulfill the requirements of the 2 nd environment (EN61800-3 category C3; EN55011 class A2). XxC40750C through XxC42000D meet the 2 nd environment requirements without added filters.

The products referenced above are for the use of control of the speed of AC motors.

Via internal mechanisms and Quality Control, it is verified that these products conform to the requirements of the Directive and applicable standards.

Chambersburg, PA, USA — February 27, 2009

Frank H. Custis
Product Marketing Manager
Harsh Duty Drives
Vacon

VACON

DRIVEN BY DRIVES

Find your nearest Vacon office
on the Internet at:

www.vacon.com

