

Contents

| | |
|--|-----------|
| 1. Copyright | 3 |
| Copyright | 3 |
| Copyright, Limitation of Liability and Revision Rights | 3 |
| 2. Safety | 5 |
| Safety | 5 |
| 3. Introduction | 7 |
| Introduction | 7 |
| 4. How to install | 11 |
| How to install | 11 |
| 5. Configuration of the system | 19 |
| Configuring the System | 19 |
| Network Variable Description | 22 |
| VSD 6010 Profile | 35 |
| Network Variable Description - VSD Profile - input | 37 |
| Network Variable Description - VSD Profile - Output | 37 |
| Network Variable Description - VSD Profile - Configuration | 39 |
| Node Object | 41 |
| Network Timer Functions | 42 |
| 6. How to control the Frequency Converter | 43 |
| How to Control the FC 100 | 43 |
| Danfoss FC Control Profile | 44 |
| 7. How to access FC 100 parameters | 49 |
| User-defined Network Variables UNVT | 49 |
| 8. Parameters | 53 |
| Parameter list | 53 |
| Parameter Group 8 | 53 |
| Parameter Group 11 | 58 |
| Data Types Supported by FC 100 | 60 |
| 9. Troubleshooting | 61 |
| Alarm Word and Warning Word | 61 |
| Extended Status Word | 64 |
| Reference Scaling | 65 |
| Network Variables - Overview | 66 |

| | |
|--------------|-----------|
| Index | 68 |
|--------------|-----------|

1. Copyright

1

1.1. Copyright

1.1.1. Copyright, Limitation of Liability and Revision Rights

This publication contains information proprietary to Danfoss A/S. By accepting and using this manual the user agrees that the information contained herein will be used solely for operating equipment from Danfoss A/S or equipment from other vendors provided that such equipment is intended for communication with Danfoss equipment over a serial communication link. This publication is protected under the Copyright laws of Denmark and most other countries.

Danfoss A/S does not warrant that a software program produced according to the guidelines provided in this manual will function properly in every physical, hardware or software environment.

Although Danfoss A/S has tested and reviewed the documentation within this manual, Danfoss A/S makes no warranty or representation, neither expressed nor implied, with respect to this documentation, including its quality, performance, or fitness for a particular purpose.

In no event shall Danfoss A/S be liable for direct, indirect, special, incidental, or consequential damages arising out of the use, or the inability to use information contained in this manual, even if advised of the possibility of such damages. In particular, Danfoss A/S is not responsible for any costs, including but not limited to those incurred as a result of lost profits or revenue, loss or damage of equipment, loss of computer programs, loss of data, the costs to substitute these, or any claims by third parties.

Danfoss A/S reserves the right to revise this publication at any time and to make changes to its contents without prior notice or any obligation to notify former or present users of such revisions or changes.

2. Safety

2.1. Safety

2.1.1. Safety note



The voltage of the frequency converter is dangerous whenever connected to mains. Incorrect installation of the motor, frequency converter or fieldbus may cause damage to the equipment, serious personal injury or death. Consequently, the instructions in this manual, as well as national and local rules and safety regulations, must be complied with.

Safety Regulations

1. The frequency converter must be disconnected from mains if repair work is to be carried out. Check that the mains supply has been disconnected and that the necessary time has passed before removing motor and mains plugs.
2. The [STOP/RESET] key on the control panel of the frequency converter does not disconnect the equipment from mains and is thus not to be used as a safety switch.
3. Correct protective earthing of the equipment must be established, the user must be protected against supply voltage, and the motor must be protected against overload in accordance with applicable national and local regulations.
4. The earth leakage currents are higher than 3.5 mA.
5. Protection against motor overload is set by *par. 1-90 Motor Thermal Protection*. If this function is desired, set *par. 1-90* to data value [ETR trip] (default value) or data value [ETR warning]. Note: The function is initialised at 1.16 x rated motor current and rated motor frequency. For the North American market: The ETR functions provide class 20 motor overload protection in accordance with NEC.
6. Do not remove the plugs for the motor and mains supply while the frequency converter is connected to mains. Check that the mains supply has been disconnected and that the necessary time has passed before removing motor and mains plugs.
7. Please note that the frequency converter has more voltage inputs than L1, L2 and L3, when load sharing (linking of DC intermediate circuit) and external 24 V DC have been installed. Check that all voltage inputs have been disconnected and that the necessary time has passed before commencing repair work.

Installation at High Altitudes



By altitudes above 2 km, please contact Danfoss Drives regarding PELV.

Warning against Unintended Start

1. The motor can be brought to a stop by means of digital commands, bus commands, references or a local stop, while the frequency converter is connected to mains. If personal safety considerations make it necessary to ensure that no unintended start occurs, these stop functions are not sufficient.
2. While parameters are being changed, the motor may start. Consequently, the stop key [STOP/RESET] must always be activated; following which data can be modified.
3. A motor that has been stopped may start if faults occur in the electronics of the frequency converter, or if a temporary overload or a fault in the supply mains or the motor connection ceases.

**Warning:**

Touching the electrical parts may be fatal - even after the equipment has been disconnected from mains.

Also make sure that other voltage inputs have been disconnected, such as external 24 V DC, load sharing (linkage of DC intermediate circuit), as well as the motor connection for kinetic back up. Refer to *VLT® HVAC Drive Operating Instructions MG.11.Ax.yy* for further safety guidelines.

2.1.2. Safety Regulations

1. 1. The frequency converter must be disconnected from mains if repair work is to be carried out. Check that the mains supply has been disconnected and that the necessary time has passed before removing motor and mains plugs.
2. The [STOP/RESET] key on the control panel of the frequency converter does not disconnect the equipment from mains and is thus not to be used as a safety switch.
3. Correct protective earthing of the equipment must be established, the user must be protected against supply voltage, and the motor must be protected against overload in accordance with applicable national and local regulations.
4. The earth leakage currents are higher than 3.5 mA.
5. Protection against motor overload is not included in the factory setting. If this function is desired, set par. 1-90 to data value ETR trip or data value ETR warning. Note: The function is initialised at 1.16 x rated motor current and rated motor frequency. For the North American market: The ETR functions provide class 20 motor overload protection in accordance with NEC.
6. Do not remove the plugs for the motor and mains supply while the frequency converter is connected to mains. Check that the mains supply has been disconnected and that the necessary time has passed before removing motor and mains plugs.
7. Please note that the frequency converter has more voltage inputs than L1, L2 and L3, when load sharing (linking of DC intermediate circuit) and external 24 V DC have been installed. Check that all voltage inputs have been disconnected and that the necessary time has passed before commencing repair work.

2.1.3. Warning against Unintended Start

1. The motor can be brought to a stop by means of digital commands, bus commands, references or a local stop, while the frequency converter is connected to mains. If personal safety considerations make it necessary to ensure that no unintended start occurs, these stop functions are not sufficient.
2. While parameters are being changed, the motor may start. Consequently, the stop key [STOP/RESET] must always be activated; following which data can be modified.
3. A motor that has been stopped may start if faults occur in the electronics of the frequency converter, or if a temporary overload or a fault in the supply mains or the motor connection ceases.



Touching the electrical parts may be fatal - even after the equipment has been disconnected from mains.

Also make sure that other voltage inputs have been disconnected, such as external 24 V DC, load sharing (linkage of DC intermediate circuit), as well as the motor connection for kinetic back up. Refer to *VLT® HVAC Drive Operating Instructions (MG.11.Ax.yy)* for further safety guidelines.

3. Introduction

3.1. Introduction

3.1.1. About this manual

First time users can obtain the most essential information for quick installation and set-up in these chapters:

Introduction

How to Install

How to Configure the System

For more detailed information including the full range of set-up options and diagnosis tools please refer to the chapters:

How to Control the FC 100

How to Access FC 100 Parameters

Parameters

Troubleshooting

Echelon®, LonTalk®, Neuron®, LonWorks® and LonMaker® are registered trademarks of the Echelon Corporation.

3.1.2. Technical Overview

The LonWorks communications structure is similar to that of a local area network (LAN) in that messages are continually exchanged between a number of processors. A LonWorks system is a local operating network (LON). LON technology offers a means for integrating various distributed systems that perform sensing, monitoring, control, and other automated functions. A LON allows these intelligent devices to communicate with one another through a variety of communications media using a standard protocol.

LON technology supports distributed, peer-to-peer communications. That is, individual network devices can communicate directly with one another without the need for a central control system. A LON is designed to move sense and control messages which are typically very short and which contain commands and status information that trigger actions. LON performance is viewed in terms of transactions completed per second and response time. Control systems do not require vast amounts of data, but they do demand that the messages they send and receive are absolutely correct.

Data are transported by means of standard network variable types (SNVTs) which provide a well-defined interface for communication between devices from different manufacturers. Functional profiles defining the functionality and network variables for a particular family of devices (e.g. frequency converters, pumps etc.) are also available, and supported by the LonWorks option.

3.1.3. Assumptions

These operating instructions assume, that the Danfoss LonWorks option is used in conjunction with a Danfoss FC 100 frequency converter. It is also assumed that the installed controller supports the interfaces described in this document and that all the requirements stipulated in the controller, as well as the frequency converter, are strictly observed along with all limitations therein.

3.1.4. Hardware

This manual relates to the *LonWorks option MCA108*, type no. 130B1106 (non-coated) and 130B1206 (coated).

3.1.5. Background Knowledge

The Danfoss LonWorks Option Card is designed to communicate with any system complying with the FTT and 78Kbps LonWorks standard. Familiarity with this technology is assumed. Issues regarding hardware or software produced by other manufacturers, including commissioning tools, are beyond the scope of this manual and are not the responsibility of Danfoss.

For information regarding commissioning tools or communication with a non-Danfoss node, please consult the appropriate manuals.

3.1.6. Related Literature for the VLT® HVAC Drive

| Title | Literature no. |
|--|----------------|
| VLT® HVAC Drive Operating Instructions | MG.11.Ax.yy |
| VLT® HVAC Drive Design Guide | MG.11.Bx.yy |
| VLT® HVAC Drive Programming Guide | MG.11.Cx.yy |

The following literature is available for the FC 100 series:

Please also refer to www.danfoss.com/BusinessAreas/DrivesSolution for additional information.

3.1.7. LonMark Certification

The LonWorks option is conform to the LonMark standards and is certified towards LonMark ver. 3.4



3.1.8. Abbreviations

| | | | |
|------|-------------------------------|-------|---------------------------------------|
| ACK | AC Knowledge | PLC | Programmable Logic Controller |
| A | Ampere | PNU | Parameter Number |
| BOOL | Boolean | RPM | Revolutions Per Minute |
| CC | Control Card | RTC | Real Time Clock |
| - | - | s | Seconds |
| CTW | Control Word | SCPT | Standard Configuration Property Types |
| EMC | Electromagnetic Compatibility | SNVT | Standard Network Variable Type |
| FTT | Free Topology Transceiver | SINT | Signed integer |
| HF | High frequency | STW | Status Word |
| Hz | Frequency in Hertz | V | Voltage |
| I/O | Input / Output | VSD | Variable Speed Drive |
| IRMS | Output Current Mean Value | - | - |
| LCP | Local Control Panel | UDINT | Unsigned double integer |
| LED | Light Emitting Diode | UINT | Unsigned integer |
| LON | Local Area Network | UNVT | User-defined Network Variable Type |
| LSB | Least Significant Bit | XIF | Extended Interface File |
| MAV | Main Active Value | | |
| MSB | Most Significant Bit | | |
| MRV | Main Reference Value | | |
| N/A | Not Applicable | | |
| PC | Personal Computer | | |

4. How to install

4.1. How to install

4.1.1. The LonWorks Option

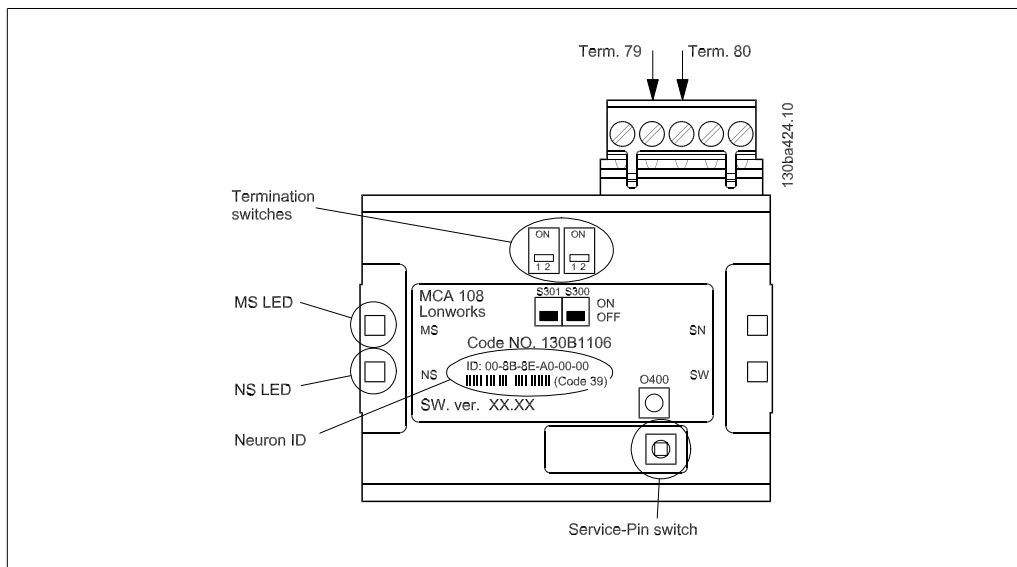

4

The LonWorks option is equipped with two termination switches, S300 and S301, enabling double termination when using bus topology. The push-button switch O400, activates the Service-Pin function. The LEDs:

| LED label | Description |
|-----------|--------------------|
| MS | Service LED (red) |
| NS | Status LED (green) |

The neuron ID is printed on the option in text and in barcode (code 39).

4.1.2. Cabling

The Free Topology Transceiver (FTT) system is designed to support free topology wiring and accommodates bus, star, loop or any combination of these topologies. The LonWorks option is equipped with the FT-X1 transceiver for improved EMC performance. Flexible wiring capability simplifies system installation and makes it easy to add nodes for system expansion. The figures below illustrate five different network topologies.

4

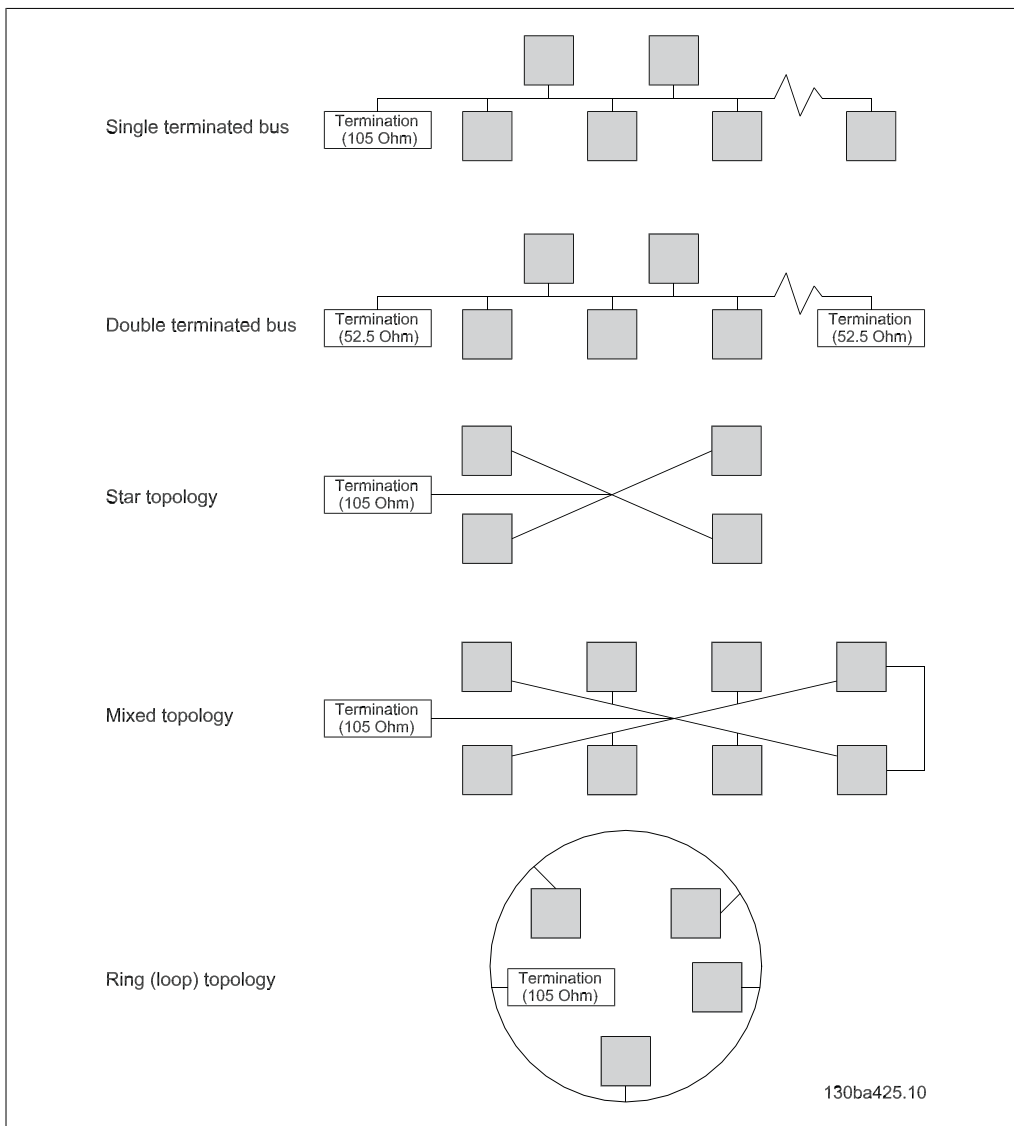

4.1.3. Network Termination

Dependent on the type of topology, at least one of the connected nodes must be terminated (105Ω). The option has two built-in termination circuits which are activated by the terminator switches S300 and S301.

If termination is provided elsewhere in the network, the termination switches should be OFF. If a double-terminated bus topology is used, the first and the last node should be double-terminated (52.5Ω).

Termination switch positions are shown in the table below.

| Termination type | S 300 | S 301 |
|----------------------------------|-------|-------|
| No termination (factory setting) | OFF | OFF |
| Single termination (105 Ω) | ON | OFF |
| Double termination (52.5 Ω) | ON | ON |

4.1.4. Connecting the Bus Line

Connect bus wire NET A to terminal 79 and NET B to 80 of the terminal connector.

| Terminal | Connection |
|----------|------------|
| 79 | NET A* |
| 80 | NET B* |
| 61 | Drain** |



NB!

***Note:** For free topology wiring the option is insensitive to the polarity of the bus-terminals.



NB!

****Note:** Term. 61 (Drain) offers a RC-junction to ground and should not be used for grounding of shielded cable. Ground the shielded cable at the de-coupling plate by removing cable insulation at contact point.

4.1.5. Maximum Cable Lengths

| Network topology | Maximum cable length |
|--|----------------------|
| Free topology without repeater | 500 m |
| Free topology with one repeater | 1000 m |
| Free topology maximum device-to-device | 500 m |
| Bus topology single terminated | 500 m |
| Bus topology double terminated without repeater | 2700 m |
| Bus topology double terminated with one repeater | 5400 m |
| Bus topology maximum stub length | 3 m |

Use of the same cable type throughout the entire network is recommended in order to avoid impedance mismatch.

4.1.6. System Specifications

Up to 64 FT-X1/FTT-10 transceivers, are allowed per network segment.



NB!

Note: The Free Topology LonWorks runs at 78 Kbps only.

4.1.7. EMC Precautions

The following EMC precautions are recommended in order to achieve interference-free operation of the LonWorks network. Additional EMC information is available in the *VLT® HVAC Drive Design Guide*.



NB!

N.B.:

Relevant national and local regulations, for example regarding protective earth connection, must be observed.

The LonWorks communication cable must be kept away from motor and brake resistor cables to avoid coupling of high frequency noise from one cable to the other. Normally a distance of 200 mm (8 inches) is sufficient, but maintaining the greatest possible distance between the cables is recommended, especially where cables run in parallel over long distances. When crossing is unavoidable, the LonWorks cable must cross motor and brake resistor cables at an angle of 90 degrees.

4

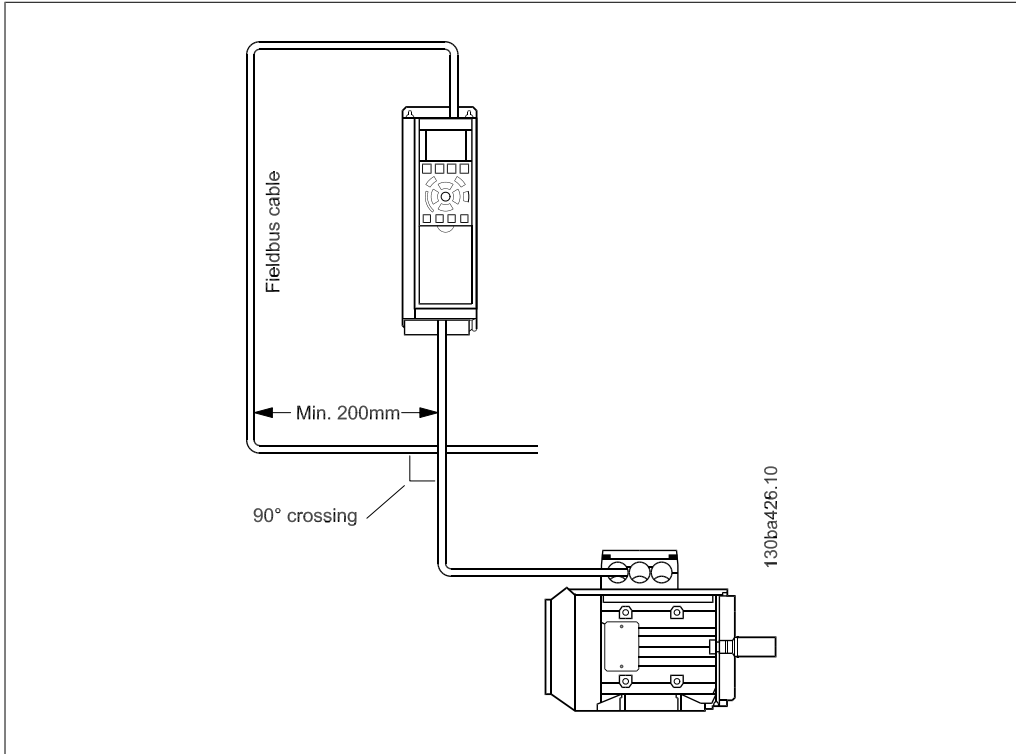

 **NB!** It is highly recommended to use suitable screened cable for any LonWorks installation!

4.1.8. LED Behaviour

MS: Service LED (red)

| Situation | LED | | Description |
|-------------------------------------|-----|---|---|
| Configured state (Normal operation) | | ½ sec. ON, then continuously OFF | The node is configured and running normally |
| Non configured state | | Flashing ½ Hz | Node is not configured but has an application. Proceed with loading node. |
| Applicationless state | | 1 sec. ON, 2 sec. OFF, then continuously ON | Node has no application, the LonWorks option needs replacing or reprogramming |
| Watchdog resets | | Short flash about each 3 sec. | Indicates problem with application. The LonWorks option needs replacing |
| Faulty hardware | | Steady ON or OFF | The LonWorks option needs replacing |

130ba421.11

NS: Status LED (green)

| Situation | LED | | Description |
|-----------------|-----|---------------------------|---|
| Node configured | | Steady ON | The node is configured and running normally |
| Wink service | | Flashing ½ Hz for 20 sec. | Wink service activated in order to identify node. |

130ba422.11

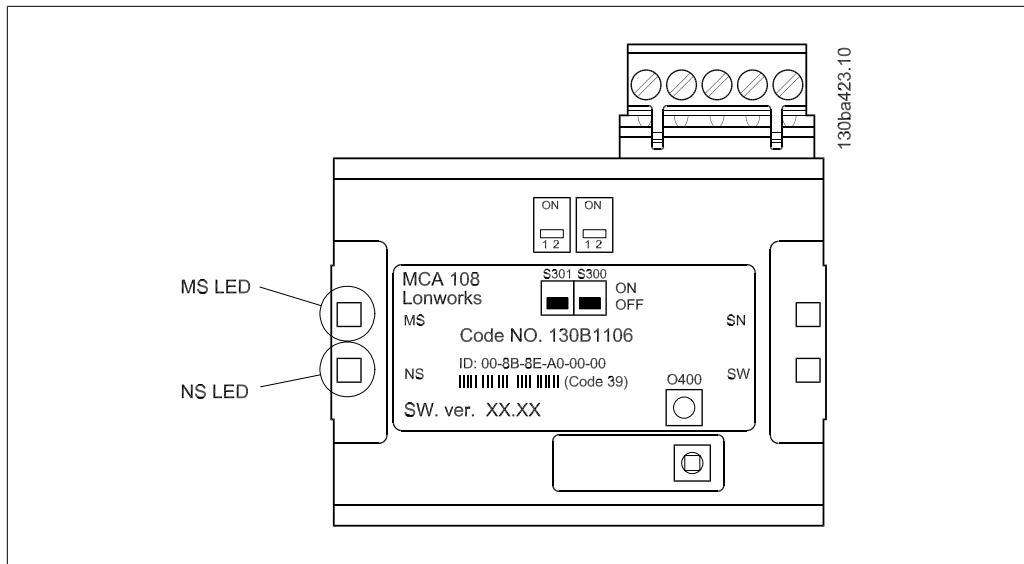

4.1.9. How to Install Option in Frequency Converter

Items required to install a fieldbus option in the frequency converter:

- The fieldbus option
- Fieldbus option adaptor frame for the FC 100. This frame is deeper than the standard frame, to allow space for the fieldbus option beneath
- Decoupling plate (only for A1 and A2 enclosures)

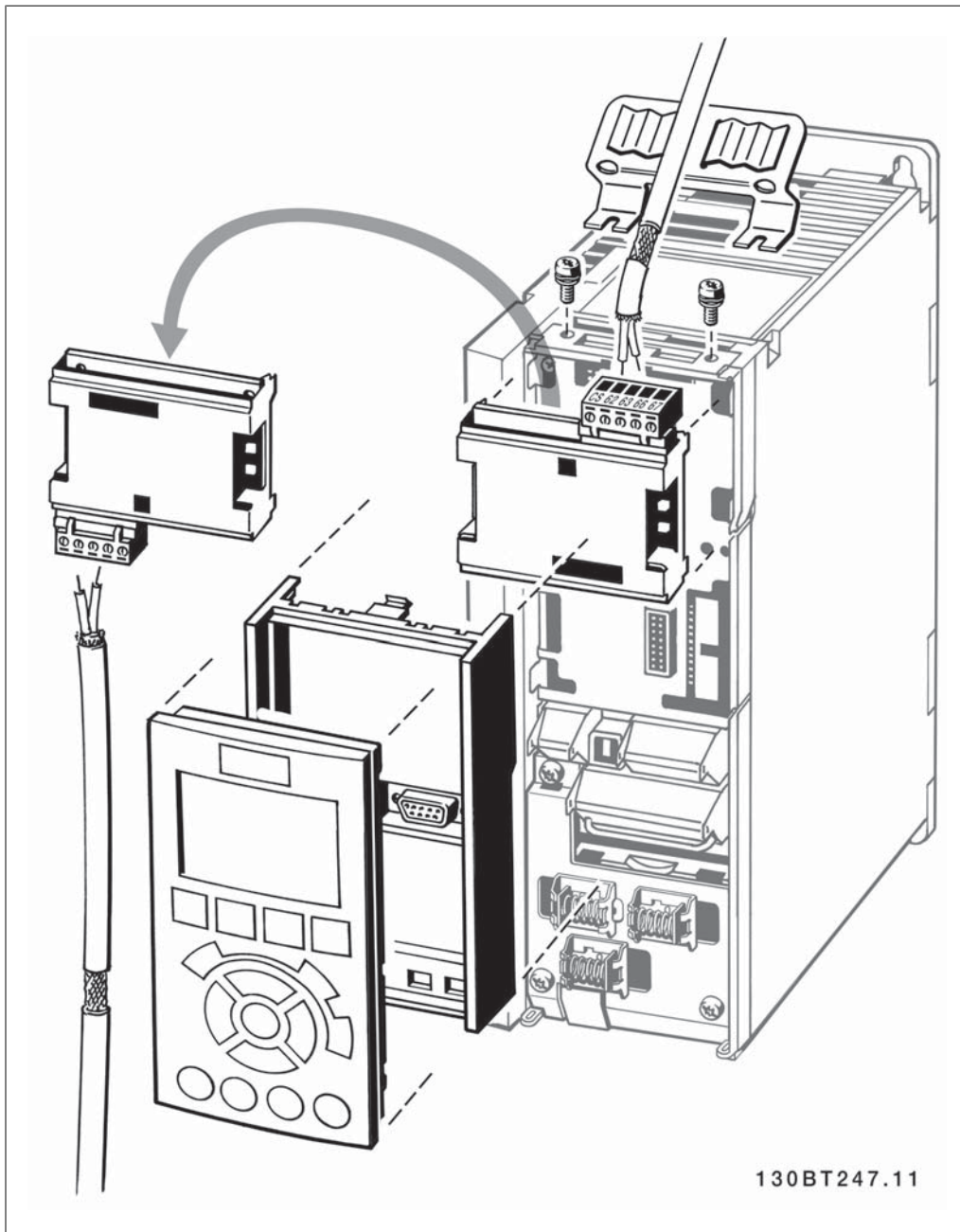

Instructions:

- Remove LCP panel from the FC 100
- Remove the frame located beneath and discard
- Push the option into place. Two positions are possible, with cable terminal facing either up or down
- Push the fieldbus option adaptor frame for the FC 100 into place
- Replace the LCP and attach cable
- On A1 and A2 enclosures with cable terminal facing up: Fasten the cable onto the de-coupling plate (the FC 100 top surface has pre-drilled threaded holes for attaching the de-coupling plate to the unit).

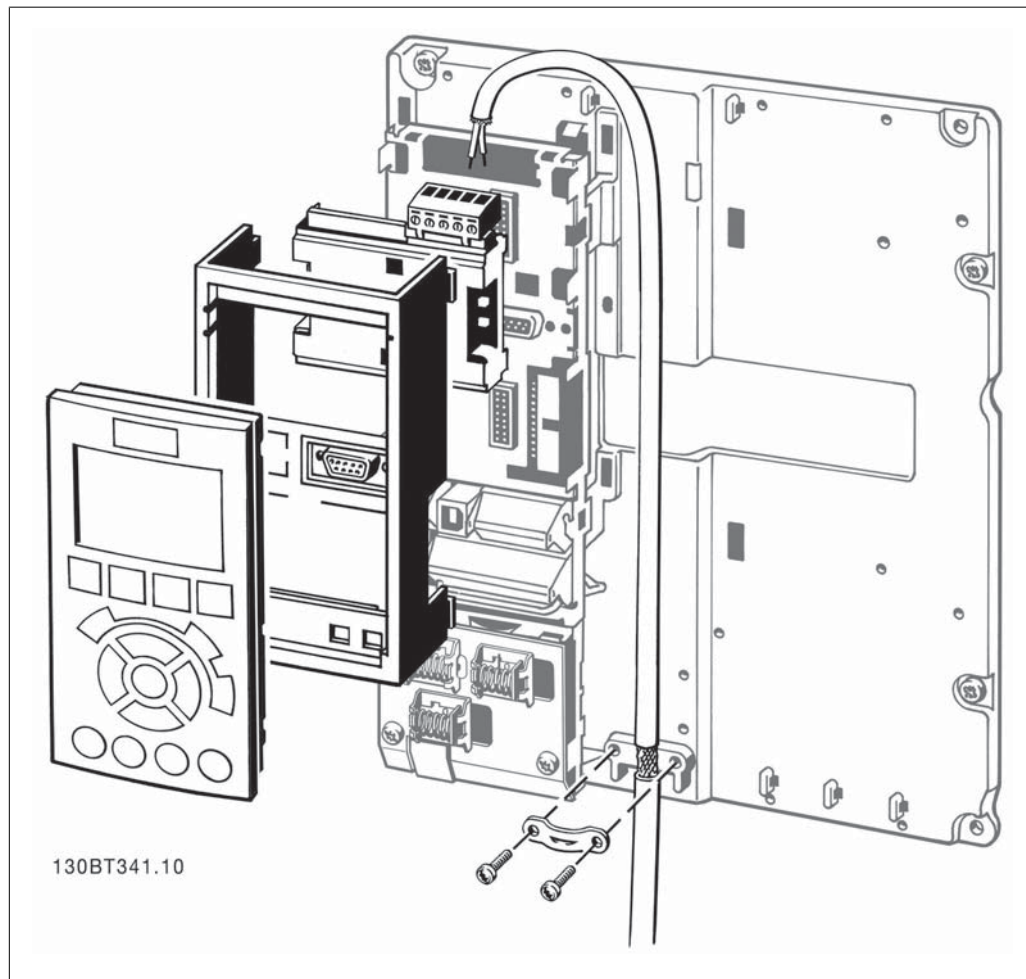

5. Configuration of the system

5.1. Configuring the System

5.1.1. How to Configure the LonWorks Network

The LonWorks option card contains a Neuron chip with a unique address. This Neuron ID is a 48 bit number that identifies each Neuron chip manufactured.

Addressing nodes on the LonWorks network is performed at the time of installation using an installation tool or network management tool (e.g. LonMaker). Addressing requires the retrieval of the Neuron ID for the node.

There are several methods by which the network software can retrieve the Neuron ID and address the node:

- 1. Service Pin** – The push-button service switch sends the Neuron ID over the network. If the network software prompts the action, press the Service Pin switch (O400) to transmit the Neuron ID over the network. Please refer to the How to Install section for the location of the Service Pin switch.
- 2. Query and Wink** - Upon receiving a Wink command, both LED's flashes (1/2 Hz for 20 sec.) so the installer can locate the node. The option sends out its Neuron ID over the network in response to the query command.
- 3. Neuron ID Label** – The installer can manually enter the Neuron ID during installation. The Neuron ID can be found on the label of the option in text and barcode.

Resource Files

A LonMark interface file (.XIF file extension) provides the host processor with device information. Using this file it is possible to design a LonWorks network without the adjustable frequency converter being physically present. Other resource files are:

- Type file (.typ file extension)
- Format file (.fmt file extension)
- Language description file (.eng, .enu and other file extensions)

The resource files can be downloaded from the web site www.danfoss.com/BusinessAreas/DrivesSolution.

Here you will also find a free download of an LNS plug-in for the use in the LonMaker tool.

5.1.2. Functional Profiles

LonMark functional profiles are used to describe in detail the application layer interface, including the network variables, configuration properties, and commonly used control functions.

5.1.3. FC VSD Profile

The FC VSD Profile describes all Danfoss VLT specific network variables.

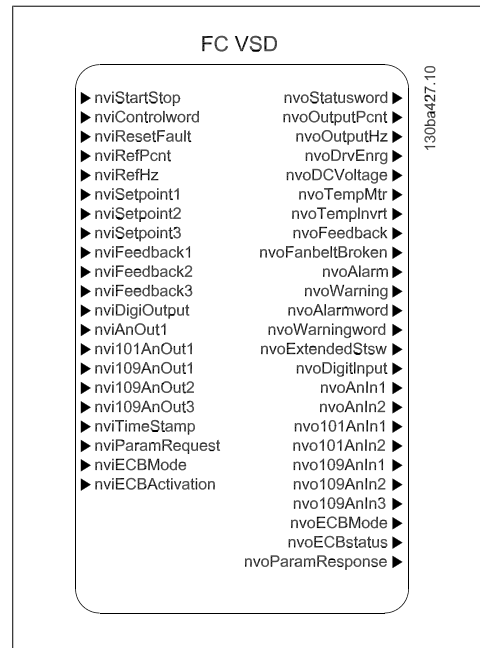

Input variables

| Variable Function | Variable Name | SNVT type | Profile | FC 100 par. |
|--------------------------|------------------|--------------------|---------|---------------|
| Start/Stop | nviStartStop | SNVT_switch | FC VSD | CTW/reference |
| Control word | nviControlword | SNVT_state | FC VSD | CTW |
| Reset fault | nviResetFaut | SNVT_switch | FC VSD | CTW |
| Reference [%] | nviRefPcnt | SNVT_lev_percent | FC VSD | Reference |
| Reference [Hz] | nviRefHz | SNVT_freq_hz | FC VSD | Reference |
| CL Setpoint 1 | nviSetpoint1 | SNVT_lev_percent | FC VSD | 20-21 |
| CL Setpoint 2 | nviSetpoint2 | SNVT_lev_percent | FC VSD | 20-22 |
| CL Setpoint 3 | nviSetpoint3 | SNVT_lev_percent | FC VSD | 20-23 |
| Bus feedback 1 | nviFeedback1 | SNVT_lev_percent | FC VSD | 8-94 |
| Bus feedback 2 | nviFeedback2 | SNVT_lev_percent | FC VSD | 8-95 |
| Bus feedback 3 | nviFeedback3 | SNVT_lev_percent | FC VSD | 8-96 |
| Digital/relay outputs | nviDigiOutput | SNVT_state | FC VSD | 5-90 |
| Analog output (42) | nviAnOut1 | SNVT_lev_percent | FC VSD | 6-53 |
| Analog output (X30/8) | nvi101AnOut1 | SNVT_lev_percent | FC VSD | 6-63 |
| Analog output (X42/7) | nvi109AnOut1 | SNVT_lev_percent | FC VSD | 26-43 |
| Analog output (X42/9) | nvi109AnOut2 | SNVT_lev_percent | FC VSD | 26-53 |
| Analog output (X42/11) | nvi109AnOut3 | SNVT_lev_percent | FC VSD | 26-63 |
| Setting of RTC | nviTimeStamp | SNVT_time_stamp | FC VSD | 0-70 |
| ECB option Mode | nviECBMode | SNVT_state | FC VSD | 31-00 |
| ECB By-pass activation | nviECBActivation | SNVT_switch | FC VSD | 31-19 |
| Parameter access command | nviParamRequest | UNVT_param_request | FC VSD | - |

Output variables

| Variable function | Variable name | SNVT type | Profile | FC 100 par. |
|-----------------------|------------------|----------------------------|---------|------------------|
| Status word | nvoStatusword | SNVT_state | FC VSD | 16-03 |
| Drive output [%] | nvoOutputPcnt | SNVT_lev_percent | FC VSD | 16-05 |
| Drive output [Hz] | nvoOutputHz | SNVT_freq_hz | FC VSD | 16-13 |
| kWh counter | nvoDrvEnrg | SNVT_elec_kwh_l | FC VSD | 15-02 |
| DC Link Voltage | nvoDCVoltage | SNVT_volt | FC VSD | 16-30 |
| Motor thermal | nvoTempMtr | SNVT_lev_cont | FC VSD | 16-18 |
| Inverter Thermal | nvoTempInvtr | SNVT_lev_cont | FC VSD | 16-35 |
| Closed loop feedback | nvoFeedback | SNVT_count_inc_f | FC VSD | 16-52 |
| Fanbelt broken | nvoBrokenBelt | SNVT_switch | FC VSD | 16-93 |
| Alarm flag | nvoAlarm | SNVT_switch | FC VSD | 16-90 |
| Warning flag | nvoWarning | SNVT_switch | FC VSD | 16-03 |
| Alarm word | nvoAlarmword | SNVT_state_64 | FC VSD | 16-90 + 16-91 |
| Warning word | nvoWarningword | SNVT_state_64 | FC VSD | 16-92 + 16-93 |
| Extended status-word | nvoExtendedStsw | SNVT_state_64 | FC VSD | 16-94 + 16-95 |
| Digital inputs | nvoDigitInput | SNVT_state_64 | FC VSD | 16-60 |
| Analog Input (53) | nvoAnIn1 | SNVT_volt/ SNVT_amp_mil | FC VSD | 16-62 |
| Analog Input (54) | nvoAnIn2 | SNVT_volt/ SNVT_amp_mil | FC VSD | 16-64 |
| Analog Input (X30/11) | nvo101AnIn1 | SNVT_volt | FC VSD | 16-75 |
| Analog Input (X30/12) | nvo101AnIn2 | SNVT_volt | FC VSD | 16-76 |
| Analog Input (X42/1) | nvo109AnIn1 | SNVT_volt/ SNVT_temp_p | FC VSD | 18-30 |
| Analog Input (X42/3) | nvo109AnIn2 | SNVT_volt/ SNVT_temp_p | FC VSD | 18-31 |
| Analog Input (X42/5) | nvo109AnIn3 | SNVT_volt/ SNVT_temp_p | FC VSD | 18-32 |
| ECB option status | nvoECBstatus | SNVT_state | FC VSD | 31-10 |
| Parameter access cmd. | nvoParamResponse | UNVT_param_response | FC VSD | - |

5.2. Network Variable Description

5.2.1. - FC VSD Profile - input

Start/Stop

| Variable name: | SNVT type: | State: | Value: | Command: |
|----------------|-------------|----------------|---------|---------------------------|
| nviStartStop | SNVT_switch | 0 (False) | Any | Stop (0x043C) |
| | | 1 (True) | 0 | Running 0% (0x047C) |
| | | 1 (True) | 1-200 | Running 0.5 to 100.0% |
| | | 1 (True) | 201-255 | Running 100% |
| | | 0xFF (default) | Any | AUTO (invalid, no action) |

This variable sends a Start or Stop command to the frequency converter and a reference (0 - 100 %)

Control Word

| Variable name: | SNVT type: | State: |
|----------------|------------|--------------------|
| nviControlword | SNVT_state | Boolean 1 bit x 16 |

The input network variable nviControlWord is a 16-bit word providing additional operational control of the frequency converter.

For more information about the Control word, please refer to the *Danfoss FC Control Profile* section.



NB!

N.B.

Please note in the representation of the Control Word in the LonMaker Browser, the LSB is to the far left.

Reset fault

| Variable name: | SNVT type: | State: | Value: | Command: |
|----------------|-------------|----------------|--------|---------------------------|
| nviResetFault | SNVT_switch | 0 (False) | Any | No reset |
| | | 1 (True) | Any | Reset (0x04B) |
| | | 0xFF (default) | Any | AUTO (invalid, no action) |

This variable sends a reset command to the frequency converter via bit 7 in the Control Word (0x04BC), see the *Danfoss FC Control Profile* section.

Reference [%]

| Variable name: | SNVT type: | Value: | | |
|----------------|------------------|-------------|-------------|--------------------|
| nviRefPcnt | SNVT_lev_percent | Min. | Max. | Resolution: |
| | | -163.840 % | +163.830 % | 0.005 % |

This variable sends the speed reference to the frequency converter. It represents a percentage of the reference range of the frequency converter.

In closed loop operation the reference is interpreted as the speed setpoint.

A negative reference will not cause reversal of the motor.

Reference [Hz]

| Variable name: | SNVT type: | Value: | | |
|----------------|--------------|--------------|--------------|--------------------|
| nviRefHz | SNVT_freq_hz | Min.: | Max.: | Resolution: |
| | | 0.0 Hz | 6,553.5 Hz | 0.1 Hz |

This variable sends the speed reference to the frequency converter in Hz, in open loop mode.

In closed loop mode it is used as the Set-point.

**NB!**

To optimize network performance and to ensure proper frequency converter operation, use only one input for reference commands.

Closed Loop Set-point 1-3

| Variable name: | SNVT type: | Value: | | |
|----------------|------------------|--------------|--------------|--------------------|
| nviSetpoint1-3 | SNVT_lev_percent | Min.: | Max.: | Resolution: |
| | | -163.840 % | 163.830 % | 0.005 % |

This variable sends up to 3 different set-points to the frequency converter via the bus.

Bus Feedback 1-3

| Variable name: | SNVT type: | Value: | | |
|----------------|------------------|--------------|--------------|--------------------|
| nviFeedback1-3 | SNVT_lev_percent | Min.: | Max.: | Resolution: |
| | | -163.840 % | 163.830 % | 0.005 % |

This variable sends up to 3 different feedback signals to the frequency converter via the bus.

**NB!**

For more information on how to manage multiple set-points and feedback sources, please refer to *VLT® HVAC Drive Design Guide*.

Digital / Relay Outputs

| Variable name: | SNVT type: | State: |
|----------------|------------|--------------------|
| nviDigitOutput | SNVT_state | Boolean 1 bit x 64 |

This variable controls the state of the digital outputs and relays.

A logical 1, indicates that the output is On or active.

A logical 0, indicates that the output is Off or inactive.

| | |
|----------|------------------------------------|
| Bit 0 | CC Digital Output Terminal 27 |
| Bit 1 | CC Digital Output Terminal 29 |
| Bit 2 | GPIO Digital Output Terminal X30/6 |
| Bit 3 | GPIO Digital Output Terminal X30/7 |
| Bit 4 | CC Relay 1 output terminal |
| Bit 5 | CC Relay 2 output terminal |
| Bit 6 | Option B Relay 1 output terminal |
| Bit 7 | Option B Relay 2 output terminal |
| Bit 8 | Option B Relay 3 output terminal |
| Bit 9-63 | Reserved for future terminals |

Analog Output (42)

| Variable name: | SNVT type: | Value: | | |
|----------------|------------------|--------|-------|-------------|
| | | Min.: | Max.: | Resolution: |
| nviAnOut1 | SNVT_lev_percent | 0 % | 100 % | 0.01 % |

This variable controls the analog output 42, 0-20 mA or 4-20 mA.

In order to control output 42 via LonWorks, par. 6-50 *Terminal 42 output* must be set to one of the following options:

[139] Bus ctrl. 0-20 mA

[140] Bus ctrl. 4-20 mA

[141] Bus ctrl. 0-20 mA Timeout

[142] Bus ctrl. 4-20 mA Timeout

Function:

Bus ctrl. 0-20 mA [139]: The output is controlled via bus. In the event of bus timeout, the output level remains unchanged.

Bus ctrl. 4-20 mA [140]: The output is controlled via bus. In the event of bus timeout, the output level remains unchanged.

Bus ctrl. 0-20 mA [141]: The output is controlled via bus. In the event of bus timeout, the output level is set to the predefined level in par. 6-54.

Bus ctrl. 4-20 mA [142]: The output is controlled via bus. In the event of bus timeout, the output level is set to the predefined level in par. 6-54.

Analog Output (X30 / 8)

| Variable name: | SNVT type: | Value: | | |
|----------------|------------------|--------------|--------------|--------------------|
| nvi101AnOut1 | SNVT_lev_percent | Min.: | Max.: | Resolution: |
| | | 0 % | 100 % | 0.01 % |

NB! This output variable applies only if the General Purpose I/O option is installed in the frequency converter.

This variable controls the X30/8 analog output on the General Purpose I/O option 0-20 mA or 4-20 mA.

In order to control output X30/8 via LonWorks, par. 6-60 *Terminal X30/8 output* must be set to one of the following options:

- [139] Bus ctrl. 0-20 mA
- [140] Bus ctrl. 4-20 mA
- [141] Bus ctrl. 0-20 mA Timeout
- [142] Bus ctrl. 4-20 mA Timeout

Function:

Bus ctrl. 0-20 mA [139]: The output is controlled via bus. In the event of bus timeout, the output level remains unchanged.

Bus ctrl. 4-20 mA [140]: The output is controlled via bus. In the event of bus timeout, the output level remains unchanged.

Bus ctrl. 0-20 mA [141]: The output is controlled via bus. In the event of bus timeout, the output level is set to the predefined level in par. 6-64.

Bus ctrl. 4-20 mA [142]: The output is controlled via bus. In the event of bus timeout, the output level is set to the predefined level in par. 6-64.

Analog Output (X42 / 7)

| Variable name: | SNVT type: | Value: | | |
|----------------|------------------|--------------|--------------|--------------------|
| nvi109AnOut1 | SNVT_lev_percent | Min.: | Max.: | Resolution: |
| | | 0 % | 100 % | 0.01 % |

Analog Output (X42 / 9)

| Variable name: | SNVT type: | Value: | | |
|----------------|------------------|--------------|--------------|--------------------|
| nvi109AnOut2 | SNVT_lev_percent | Min.: | Max.: | Resolution: |
| | | 0 % | 100 % | 0.01 % |

Analog Output (X42 /11)

| Variable name: | SNVT type: | Value: | | |
|----------------|------------------|--------------|--------------|--------------------|
| nvi109AnOut3 | SNVT_lev_percent | Min.: | Max.: | Resolution: |
| | | 0 % | 100 % | 0.01 % |

These variables contain the value allocated to the analog output terminal X42/7-11 of the *Analog I/O option*. The variable type is changeable with the commissioning tool.

NB! This variable is available only if the Analog I/O option (MCB 109) has been installed.

Setting of RTC

| Variable name: | SNVT type: | Field: | | | | | |
|----------------|-----------------|---------------|--------|--------|--------|--------|--------|
| nviTimeStamp | SNVT_time_stamp | Year | Month | Day | Hour | Minute | Second |
| | | 2000 -3000 | 0 - 12 | 0 - 31 | 0 - 23 | 0 - 59 | 0 - 59 |

Use this input to set the built-in Real Time Clock.

ECB Option Mode

| Variable name: | SNVT type: | State: |
|----------------|------------|--------------------|
| nviECBMode | SNVT_state | Boolean 1 bit x 16 |

Controls the operation mode of the ECB option. The binary value of this variable is mapped directly into par. 31-00.

- [0] Drive
- [1] Bypass

ECB Remote By-pass Activation

| Variable name: | SNVT type: | State: |
|------------------|------------|--------------------|
| nviECBActivation | SNVT_state | Boolean 1 bit x 16 |

Controls the remote activation of the ECB option. The binary value of this variable is mapped directly into par. 31-90.

- [0] Disabled
- [1] Enabled

NB! This input variable applies only if the ECB option is installed in the frequency converter.

Parameter Access Command

| Variable name: | SNVT type: | Value: |
|-----------------|--------------------|--------|
| nviParamRequest | SNVT_param_request | |

5

These input variables are used for for frequency converter parameter access.
For more information on parameter access, please refer to *How to Access FC 100 Parameters* section.

5.2.2. Network variable description - FC VSD Profile - output

Status Word

| Variable name: | SNVT type: | State: |
|----------------|------------|--------------------|
| nvoStatusWord | SNVT_state | Boolean 1 bit x 16 |

This variable is a 16-bit word providing status information on the frequency converter. For more information on the status word, please refer to the *Danfoss FC Control Profile* section.



NB!

Please note that in the representation of the Status Word in the LonMaker Browser, the Least Significant Bit (LSB) is to the far left.

Drive Output [%]

| Variable name: | SNVT type: | Value: | | |
|----------------|------------------|------------|------------|-------------|
| | | Min. | Max. | Resolution: |
| nvoOutputPcnt | SNVT_lev_percent | -163.840 % | +163.840 % | 0.005 % |

In open loop operation, this variable contains the frequency converter output frequency in percentage, within the reference range.

In closed loop operation, this variable contains the frequency converter feedback signal, within the reference range.

Drive Output [Hz]

| Variable name: | SNVT type: | Value: | | |
|----------------|--------------|--------|----------|-------------|
| | | Min. | Max. | Resolution: |
| nvoOutputHz | SNVT_freq_hz | 0 Hz | 6,500 Hz | 1 Hz |

This variable displays the actual output of the frequency converter motor frequency in Hz.

kWh Counter [kWh]

| Variable name: | SNVT type: | Value: | | |
|----------------|-----------------|--------|------------|-------------|
| | | Min. | Max. | Resolution: |
| nvoDrvEnrg | SNVT_elec_kwh_l | 0 kWh | 65,535 kWh | 1 kWh |

This variable contains the power consumption of the motor in kWh measured as a mean value over a one hour period.

DC Link Voltage [V]

| Variable name: | SNVT type: | Value: | | |
|----------------|------------|--------|----------|-------------|
| | | Min. | Max. | Resolution: |
| nvoDCVoltage | SNVT_volt | 0 V | 10,000 V | 0.1 V |

This variable contains the measured Dc-link voltage. The value is filtered and therefore may be delayed with up to 1.3 seconds before a voltage change is reflected in the output variable.

Motor Thermal [%]

| Variable name: | SNVT type: | Value: | | |
|----------------|---------------|--------|-------|-------------|
| | | Min. | Max. | Resolution: |
| nvoTempMrt | SNVT_lev_cont | 0 % | 100 % | 0.5 % |

This variable contains the calculated / estimated thermal load on the motor. The cut-out limit is at 100%.

Inverter Thermal [%]

| Variable name: | SNVT type: | Value: | | |
|----------------|---------------|--------|-------|-------------|
| | | Min. | Max. | Resolution: |
| nvoTempInvrtr | SNVT_lev_cont | 0 % | 100 % | 0.5 % |

This variable contains the percentage thermal load of the inverters. The cut-out limit is at 100%.

Closed Loop Feedback

| Variable name: | SNVT type: | Value: | | |
|----------------|------------------|--------|-------|-------------|
| | | Min. | Max. | Resolution: |
| nvoFeedback | SNVT_count_inc_f | 0 % | 100 % | 0.5 % |

This variable contains the amount of network feedback in closed loop mode.

Fanbelt broken

| Variable name: | SNVT type: | State: | Value: | Command: |
|----------------|-------------|-----------|--------|--------------------|
| nvoBrokenbelt | SNVT_switch | 0 (False) | Any | Fanbelt not broken |
| | | 1 (True) | Any | Fanbelt broken |

This variable indicates whether the fanbelt is intact or broken (indicated by bit 8 in Warning Word 2).

Alarm Flag

| Variable name: | SNVT type: | State: | Value: | Command: |
|----------------|-------------|-----------|--------|---------------------|
| nvoAlarm | SNVT_switch | 0 (False) | Any | No alarm(s) present |
| | | 1 (True) | Any | Alarm(s) present |

This variable indicates whether any alarm is present.

Warning Flag

| Variable name: | SNVT type: | State: | Value: | Command: |
|----------------|-------------|-----------|--------|-----------------------|
| nvoWarning | SNVT_switch | 0 (False) | Any | No warning(s) present |
| | | 1 (True) | Any | Warning(s) present |

This variable indicates whether any warning is present.

Alarm Word

| Variable name: | SNVT type: | State: |
|----------------|---------------|--------------------|
| nvoAlarmword | SNVT_state_64 | Boolean 1 bit x 64 |

This variable contains the complete alarm word.

For more detailed information on the Alarm Word, please refer to the *Troubleshooting* section of this manual.

**NB!**

Please note that in the representation of the Alarm Word in the LonMaker Browser, the Least Significant Bit (LSB) is to the far left.

Warning Word

| Variable name: | SNVT type: | State: |
|----------------|---------------|--------------------|
| nvoWarningword | SNVT_state_64 | Boolean 1 bit x 64 |

This variable contains the complete warning word.

For more detailed information on the Warning Word, please refer to the *Troubleshooting* section of this manual.

**NB!**

Please note that in the representation of the Warning Word in the LonMaker Browser, the Least Significant Bit (LSB) is to the far left.

Extended Status Word

| Variable name: | SNVT type: | State: |
|-----------------|---------------|--------------------|
| nvoExtendedStsw | SNVT_state_64 | Boolean 1 bit x 64 |

This variable contains the complete extended status word.
 For more detailed information on the Extended Status Word, please refer to the *Troubleshooting* section of this manual.

NB! Please note that in the representation of the Extended Status Word in the LonMaker Browser, the Least Significant Bit (LSB) is to the far left.

Digital Inputs

| Variable name: | SNVT type: | State: |
|----------------|---------------|--------------------|
| nvoDigitInput | SNVT_state_64 | Boolean 1 bit x 64 |

This variable contains the status of the digital inputs.
 A logical 1, indicates that the input is On or active.
 A logical 0, indicates that the input is Off or inactive.

| | |
|-----------|-------------------------------------|
| Bit 0 | Digital Input Terminal 33 |
| Bit 1 | Digital Input Terminal 32 |
| Bit 2 | Digital Input Terminal 29 |
| Bit 3 | Digital Input Terminal 27 |
| Bit 4 | Digital Input Terminal 19 |
| Bit 5 | Digital Input Terminal 18 |
| Bit 6 | Reserved for future terminals |
| Bit 7 | Digital Input GP I/O Terminal X30/2 |
| Bit 8 | Digital Input GP I/O Terminal X30/3 |
| Bit 9 | Digital Input GP I/O Terminal X30/4 |
| Bit 10-63 | Reserved for future terminals |

Analog Input (53)

| Variable name: | SNVT type: | Value: | | |
|----------------|--------------|--------|-------|-------------|
| | | Min. | Max. | Resolution: |
| nvoAnIn1 | Changeable | | | |
| | SNVT_volt | 0 V | 10 V | 0.1 V |
| | SNVT_amp_mil | 0 mA | 20 mA | 0.1 mA |

This variable contains the value allocated to the analog input terminal 53.
 This terminal can either be configured as a voltage input (0-10 V) or as a current input (0-20 mA), depending on the setting of switch S 201. The variable type is changeable with the commissioning tool or LNS Plug-in in order to match the appropriate unit.

Analog Input (54)

| Variable name: | SNVT type: | Value: | | |
|----------------|--------------|--------|-------|-------------|
| nvoAnIn1 | Changeable | Min. | Max. | Resolution: |
| | SNVT_volt | 0 V | 10 V | 0.1 V |
| | SNVT_amp_mil | 0 mA | 20 mA | 0.1 mA |

This variable contains the value allocated to the analog input terminal 54. This terminal can either be configured as a voltage input (0-10 V) or as a current input (0-20 mA), depending on the setting of switch S 202. The variable type is changeable with the commissioning tool in order to match the appropriate unit.

Analog Input (X30/11)

| Variable name: | SNVT type: | Value: | | |
|----------------|------------|--------|------|-------------|
| nvo101AnIn1 | SNVT_volt | Min. | Max. | Resolution: |
| | | 0 V | 10 V | 0.1 V |

This variable contains the value allocated to the analog input terminal X30/11 of the *General Purpose I/O option*.

**NB!**

This variable is available only if the General Purpose I/O option (MCB 101) has been installed.

Analog Input (X30/12)

| Variable name: | SNVT type: | Value: | | |
|----------------|------------|--------|------|-------------|
| nvo101AnIn2 | SNVT_volt | Min. | Max. | Resolution: |
| | | 0 V | 10 V | 0.1 V |

This variable contains the value allocated to the analog input terminal X30/11 of the *General Purpose I/O option*.

**NB!**

This variable is available only if the General Purpose I/O option (MCB 101) has been installed.

Analog Input (X42/1)

| Variable name: | SNVT type: | Value: | | |
|----------------|-------------|------------|-----------|-------------|
| nvo109AnIn1 | Changeable | Min. | Max. | Resolution: |
| | SNVT_volt | 0 V | 10 V | 0.1 V |
| | SNVT_temp_p | -273.15 °C | 327.66 °C | 0.01 °C |

Analog Input (X42/3)

| Variable name: | SNVT type: | Value: | | |
|----------------|-------------|------------|-----------|-------------|
| | | Min. | Max. | Resolution: |
| nvo109AnIn2 | Changeable | | | |
| | SNVT_volt | 0 V | 10 V | 0.1 V |
| | SNVT_temp_p | -273.15 °C | 327.66 °C | 0.01 °C |

Analog Input (X42/5)

| Variable name: | SNVT type: | Value: | | |
|----------------|-------------|------------|-----------|-------------|
| | | Min. | Max. | Resolution: |
| nvo109AnIn3 | Changeable | | | |
| | SNVT_volt | 0 V | 10 V | 0.1 V |
| | SNVT_temp_p | -273.15 °C | 327.66 °C | 0.01 °C |

These variables contain the value allocated to the analog input terminal X42/1-5 of the *Analog I/O option*. The variable type is changeable with the commissioning tool.

NB! This variable is available only if the Analog I/O option (MCB 109) has been installed.

ECB Option Status

| Variable name: | SNVT type: | State: |
|----------------|------------|--------------------|
| nvoECBStatus | SNVT_state | Boolean 1 bit x 64 |

This variable displays the current status of the ECB option.

NB! These variables are available only if the *Electronic Control By-pass option* (ECB) has been installed.

- Bit 0 Test Mode
- Bit 1 Drive Mode
- Bit 2 Automatic By-pass Mode
- Bit 3 By-pass Mode
- Bit 4 Reserved
- Bit 5 Motor Running from By-pass/Drive
- Bit 6 Overload Trip
- Bit 7 M2 Contactor Fault
- Bit 8 M3 Contactor Fault
- Bit 9 External Interlock
- Bit 10 Manual By-pass Override

Parameter Access Response

| | |
|---|--|
| Variable name: nvoParamResponse | SNVT type: UNVT_param_response |
|---|--|

This output variable is used for the frequency converter access.
A special UNVT has been defined for this variable.
For more information on parameter access, please refer to the *How to Access FC 100 Parameters* section.

5.3. VSD 6010 Profile

5.3.1. Introduction

The *Variable Speed Drive 6010* profile is a LonMark standardized functional profile.

It describes how to control a variable speed frequency converter.

For example, an air handling unit controller that sends messages to facilitate control of the start/stop and speed reference of the VSD. The VSD will deliver messages such as the actual frequency converter speed and output current to the controller, operating interfaces and energy management systems.

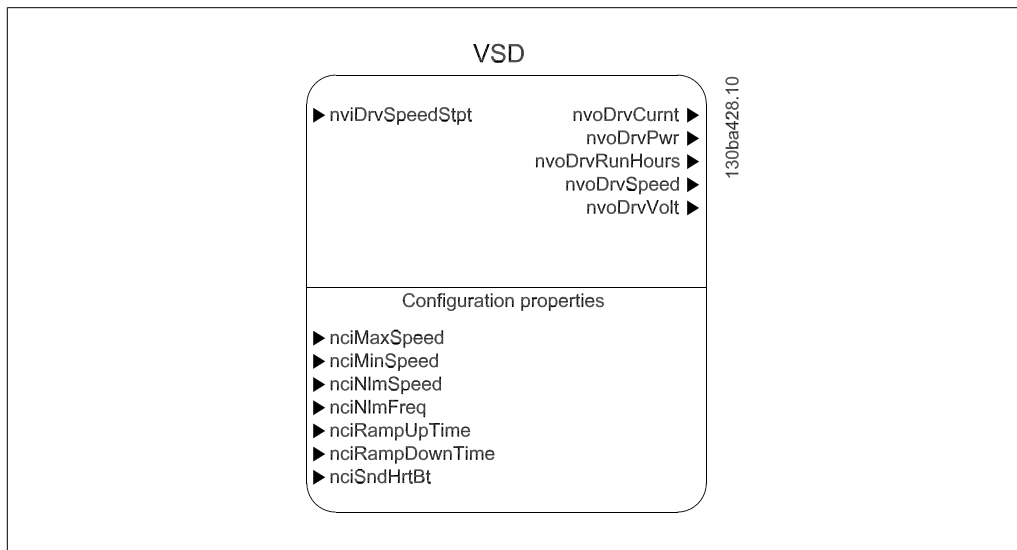

5

5.3.2. Input Variables

| Variable function | Variable name | SNVT type | Profile | FC 100 parameter |
|----------------------|-----------------|-------------|----------|------------------|
| Drive speed setpoint | nviDrvSpeedStpt | SNVT_switch | VSD 6010 | CTW / Reference |

5.3.3. Output Variables

| Variable function | Variable name | SNVT type | Profile | FC 100 parameter |
|-------------------|----------------|------------------|----------|------------------|
| Drive speed | nvoDrvSpeed | SNVT_lev_percent | VSD 6010 | 16-05 |
| Output current | nvoDrvCurnt | SNVT_amp | VSD 6010 | 16-14 |
| Output voltage | nvoDrvVolt | SNVT_volt | VSD 6010 | 16-12 |
| Output power | nvoDrvPwr | SNVT_power_kilo | VSD 6010 | 16-10 |
| Running hours | nvoDrvRunHours | SNVT_time_hour | VSD 6010 | 15-01 |

5.3.4. Configuration Properties (nci)

| Variable function | Variable name | SNVT type | Profile | FC 100 parameter |
|---------------------------|-----------------|-------------------|----------|------------------|
| Max. motor speed [%] | nciMaxSpeed | SNVT_lev_per-cent | VSD 6010 | 4-13 |
| Min. motor speed [%] | nciMinSpeed | SNVT_lev_per-cent | VSD 6010 | 4-11 |
| Nom. motor speed [RPM] | nciNmlSpeed | SNVT_rpm | VSD 6010 | 1-25 |
| Nom. motor frequency [Hz] | nciNmlFreq | SNVT_freq_hz | VSD 6010 | 1-23 |
| Min. ramp-up time [s] | nciRampUpTime | SNVT_time_sec | VSD 6010 | 3-41 |
| Min. ramp-down time [s] | nciRampDownTime | SNVT_time_sec | VSD 6010 | 3-42 |
| Heartbeat time [s] | nciSndHrtBt | SNVT_time_sec | VSD 6010 | - |

A range of network configuration variables (SCPT's) is available for configuration of the frequency converter parameters. These parameters require setting only once, usually following installation.



NB!

Please note that the settings written to configuration properties (nci's) will be stored in the non-volatile memory. Continuous writing to configuration properties may damage the non-volatile memory.

5.4. Network Variable Description - VSD Profile - input

5.4.1. Frequency Converter Speed Setpoint

| Variable name: | SNVT type: | State: | Value: | Command: |
|-----------------|-------------|----------------|---------|---------------------------|
| nviDrvSpeedStpt | SNVT_switch | 0 (False) | Any | Stop |
| | | 1 (True) | 0 | Running 0 % |
| | | 1 (True) | 1-200 | Running 0.5 to 100 % |
| | | 1 (True) | 201-255 | Running 100 % |
| | | 0xFF (default) | Any | AUTO (invalid, no action) |

This input variable provides start / stop control and a speed reference.

5

5.5. Network Variable Description - VSD Profile - Output

5.5.1. Drive Speed

| Variable name: | SNVT type: | Value: | | |
|----------------|------------------|------------|------------|-------------|
| nvoDrvSpeed | SNVT_lev_percent | Min: | Max: | Resolution: |
| | | -163.840 % | +163.830 % | 0.005 % |

This variable contains the frequency converter speed as a percentage of the nominal speed.

5.5.2. Output Current

| Variable name: | SNVT type: | Value: | | |
|----------------|------------|--------|-----------|-------------|
| nvoDrvCurrt | SNVT_amp | Min: | Max: | Resolution: |
| | | 0 A | 3,276.6 A | 0.1 A |

This variable contains the frequency converter output current in ampere measured as a mean value, IRMS.

The value is filtered and therefore approximately 1.3 seconds delayed before a current change is reflected in the output variable.

5.5.3. Output Voltage

| Variable name: | SNVT type: | Value: | | |
|----------------|------------|--------|-----------|-------------|
| nvoDrvVolt | SNVT_volt | Min: | Max: | Resolution: |
| | | 0 V | 3,276.6 V | 0.1 V |

This variable contains the frequency converter output voltage.

5.5.4. Output Power

| Variable name: | SNVT type: | Value: | | |
|----------------|-----------------|--------|------------|-------------|
| nvoDrvPwr | SNVT_power_kilo | Min: | Max: | Resolution: |
| | | 0 kW | 6,554.4 kW | 0.1 kW |

This variable contains the frequency converter output power in kW, calculated on the basis of the actual motor voltage and current.

The value is filtered and therefore approximately 1.3 seconds delayed before a power change is reflected in the output variable.

5

5.5.5. Running Hours

| Variable name: | SNVT type: | Value: | | |
|----------------|----------------|--------|-----------|-------------|
| nvoDrvRunHours | SNVT_time_hour | Min: | Max: | Resolution: |
| | | 0 hr | 65,534 hr | 1 hr |

This variable contains the total running hours of the motor.

5.6. Network Variable Description - VSD Profile - Configuration

5.6.1. Max Motor Speed [%]

| Variable name: | SNVT type: | Default value: | Min value: | Max value: |
|----------------|------------------|----------------|------------|------------|
| nciMaxSpeed | SNVT_lev_percent | 100 % | 0 % | 163.830 % |

This variable configures the maximum motor speed in % and associates it with par. 4-13 *Motor Speed High Limit* (par. 4-14 in Hz mode).

The value is entered as a percent of nominal speed, as defined by the Nominal Speed (nciNmlSpeed) configuration value.

For more information on reference scaling, please refer to the *How to Control the FC 100* section. If a value higher than 163.830% is requested, use the parameter access command.

5.6.2. Min Motor Speed [%]

| Variable name: | SNVT type: | Default value: | Min value: | Max value: |
|----------------|------------------|----------------|------------|------------|
| nciMinSpeed | SNVT_lev_percent | 0 % | 0 % | 163.830 % |

This variable configures the minimum motor speed in % and associates it with par. 4-11 *Motor Speed Low Limit* (par. 4-12 in Hz mode).

The value is entered as a percent of nominal speed, as defined by the Nominal Speed (nciNmlSpeed) configuration value.

For more information on reference scaling, please refer to the *How to Control the FC 100* section

5.6.3. Nom Motor Speed [RPM]

| Variable name: | SNVT type: | Default value: | Min value: | Max value: |
|----------------|------------|----------------|------------|------------|
| nciNmlSpeed | SNVT_rpm | 1420 RPM | 10 RPM | 65,534 RPM |

This variable configures the nominal motor speed in RPM and associates it with par. 1-25 *Motor Nominal Speed*.



NB!

Please note that this variable can be adjusted only while the frequency converter is stopped.

If a value lower than 10 RPM is entered, nciNmlSpeed will be set to 10 RPM.

5.6.4. Nominal Motor Frequency [Hz]

| Variable name: | SNVT type: | Default value: | Min value: | Max value: |
|----------------|--------------|----------------|------------|------------|
| nciNmlFreq | SNVT_freq_hz | 50 Hz | 20 Hz | 100 Hz |

This variable configures the nominal motor frequency and associates it with par. 1-23 *Motor Nominal Frequency*.

**NB!**

Please note that this variable can be adjusted only while the frequency converter is stopped.
If a value lower than 20 Hz is entered, nciNmlFreq will be set to 20 Hz.

5.6.5. Min Ramp-up Time [s]

| Variable name: | SNVT type: | Default value: | Min value: | Max value: |
|----------------|---------------|----------------|------------|------------|
| nciRampUpTime | SNVT_time_sec | 10 s | 1 s | 3,600 s |

This variable configures the Ramp 1 ramp-up time and associates it with par. 3-41 *Ramp 1 ramp-up time*.

5.6.6. Min Ramp-down Time [s]

| Variable name: | SNVT type: | Default value: | Min value: | Max value: |
|------------------|---------------|----------------|------------|------------|
| nciRampDown-Time | SNVT_time_sec | 10 s | 1 s | 3,600 s |

This variable configures the Ramp 1 ramp-down time and compares it with par. 3-42 *Ramp 1 ramp-down time*.

5.6.7. Heartbeat Time [s]

| Variable name: | SNVT type: | Default value: | Min value: | Max value: |
|----------------|---------------|----------------|------------|------------|
| nciSndHrtBt | SNVT_time_sec | 0 s | 0 s | 6,553.4 s |

This variable configures a heartbeat timer to send the following variables:

nvoDrvCurnt
nvoDrvSpeed
nvoDrvVolt
nvoDrvPwr

Setting the timer to 0.0 disables the timer.

Heartbeat timers have the purpose of sending out heartbeat signals containing specific data, enabling management systems to prove that the node is present on the network and working correctly. Only bound variables will be transmitted.

5.7. Node Object

5.7.1. Node Object

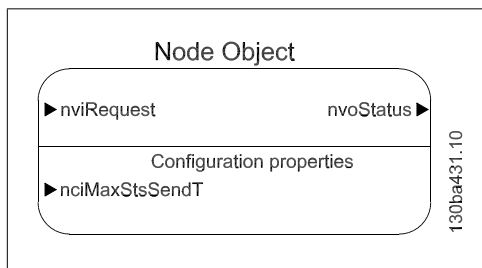

These variables are used for controlling all functional blocks via the commissioning tool.

5.7.2. Object Request

| Variable name: | SNVT type: | Supported functions: | Description: |
|----------------|------------------|----------------------|--|
| nviRequest | SNVT_obj_request | RQ_Normal | Returns the specified functional block to normal operation. |
| | | RQ_Update_Status | Requests the status of the specified functional block. |
| | | RQ_Report_Mask | Requests a status mask reporting the status bits that are supported by the specified functional block. |
| | | RQ_Disabled | Requests the specified functional block to change to the disabled state. In the disabled state, output network variables belonging to the functional block are not propagated within the network. |
| | | RQ_Enable | Requests the specified functional block to change to the enabled state. In the enabled state, output network variables belonging to the functional block are propagated within the network as defined by the functional block. |

5.7.3. Object Response

| Variable name: | SNVT type: | Description: |
|----------------|--------------------|--|
| nvoStatus | SNVT_object_status | This output network variable reports the status for any functional block on a device. It is also used to report the status of the entire device and all functional blocks on the device. |

5.7.4. Max. Send Time (Heartbeat)

| Variable name: | SNVT type: | Default value: | Min value: | Max value: |
|----------------|-----------------|----------------|------------|---------------|
| nciMaxStsSendT | SNVT_elapsed_tm | 00:0:0:0 | 00:0:0:0 | 017:59:59:999 |

This variable configures a timer to send the nvoStatus object but only if bound to an input variable. Maximum is '0 17:59:59:999' (0 days, 17 hours, 59 minutes, 59 seconds and 999 milliseconds). Setting the timer to '0 0:0:0:0' disables it.

Network timer functions monitor node presence and control behaviour in the event of network problems occurring.

5.8. Network Timer Functions

5.8.1. Control Word Time-out Function

Parameter 8-03 Control Word Timeout Time and parameter 8-04 Control Word Timeout Function provide a means for the frequency converter to control communication to a controller node.

If a valid control word has not been received within the time specified in par. 8-03, the action specified in par. 8-04 will be performed. The default action is OFF (no action).

The range of par. 8-03 is: 0.1 to 18,000 seconds (or 5 hours).

An update of the control word is triggered by the following SNVT's:

- nviStartStop
- nviResetFault
- nviControlword
- nviDrvSpeedStpt
- nviRefPcnt
- nviRefHz
- nviFeedback 1,2,3
- nviSetPoint 1,2,3

5.8.2. Min. Send Time (Inhibit Timer)

| Variable name: | SNVT type: | Default value: | Min value: | Max value: |
|----------------|-----------------|----------------|-------------|---------------|
| nciMinSendT | SNVT_elapsed_tm | 00:0:0:500 | 0 0:0:0:100 | 0 0:01:05:535 |

Variable used for limiting bus traffic by setting a minimum sending timer (inhibit timer).

Applies for all output variables.

Format: Days Hours:Minutes:Seconds:Milliseconds.

6. How to control the Frequency Converter

6.1. How to Control the FC 100

6.1.1. Reference Handling

Select the frequency converter configuration mode in par. 1-00 *Configuration Mode*.

[0] Open Loop

[3] Closed Loop

For open loop operation, the reference represents the desired output speed of the frequency converter.

The speed reference value is transmitted to the frequency converter as a relative value in %.

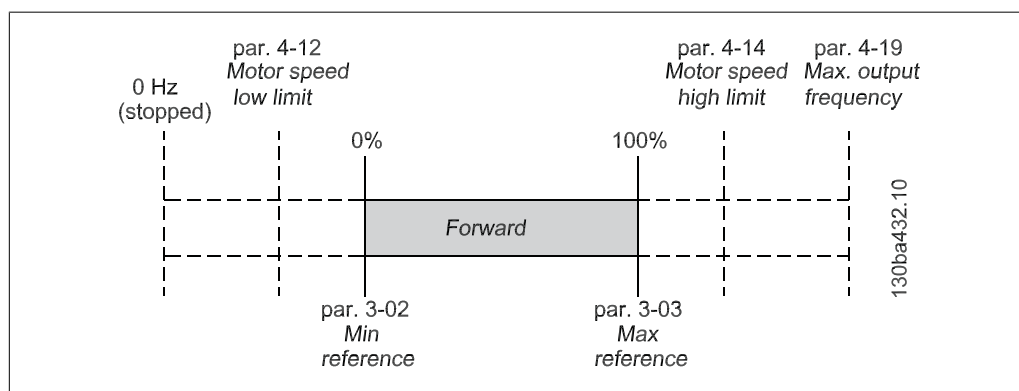

Please refer to the *Troubleshooting* section to see an example of reference scaling.

All references provided to the frequency converter are added to the total reference value.

If a reference is to be controlled by the LonWorks bus only, please ensure that all other reference inputs are zero.

This means that digital and analog input terminals should not be used for reference signals.

The default setting (0%) should be maintained for preset references in par. 3-10 *Preset Reference*.

6.2. Danfoss FC Control Profile

6.2.1. FC Control Profile

Control Word According to FC Profile (Parameter 8-10 set to *FC Profile*)

| Bit | Bit value=0 | Bit value=1 |
|-----|-------------------|------------------------|
| 00 | Reference value | External selection lsb |
| 01 | Reference value | External selection msb |
| 02 | DC brake | Ramp |
| 03 | Coasting | No coasting |
| 04 | Quick stop | Ramp |
| 05 | Hold output freq. | Use ramp |
| 06 | Ramp stop | Start |
| 07 | No function | Reset |
| 08 | No function | Jog |
| 09 | Ramp 1 | Ramp 2 |
| 10 | Data invalid | Data valid |
| 11 | No function | Relay 01 active |
| 12 | No function | Relay 04 active |
| 13 | Parameter set-up | Selection lsb |
| 14 | Parameter set-up | Selection msb |
| 15 | No function | Reverse |

6.2.2. Explanation of the Control Bits

Bits 00 and 01:

Bits 00 and 01 are used to choose between the four reference values, which are pre-programmed in par. 3-10 Preset Reference in accordance with the following table:

| Programmed ref. value | Parameter | Bit 01 | Bit 00 |
|-----------------------|-----------|--------|--------|
| 1 | 3-10 [0] | 0 | 0 |
| 2 | 3-10 [1] | 0 | 1 |
| 3 | 3-10 [2] | 1 | 0 |
| 4 | 3-10 [3] | 1 | 1 |



NB!

In par. 8-56 *Preset reference select*, a selection is made to define how Bit 00/01 gates with the corresponding function on the digital inputs.

Bit 02, DC brake:

Bit 02 set to [0] leads to DC braking and stop of the motor. Braking current and duration are set in par. 2-01 *DC Brake Current* and par. 2-02 *DC Braking Time*.

Bit 02 set to [1] leads to ramping.

Bit 03, Coasting:

Bit 03 set to [0] causes the frequency converter to immediately release of the motor (the output transistors are "shut off"), so that it coasts to a standstill.

Bit 03 set to [1] enables the frequency converter to start the motor if other starting conditions have been fulfilled.



NB!

In par. 8-50 *Coasting Select*, a selection is made to define how Bit 03 gates with the corresponding function on a digital input.

Bit 04, Quick Stop:

Bit 04 set to [0] causes a stop in which the motor speed is ramped down to stop via par. 3-81 *Quick Stop Ramp Time*.

Bit 05, Hold output frequency:

Bit 05 set to [0] causes the present output frequency (Hz) to freeze. The frozen output frequency can then be changed only by means

of the digital inputs set by par. 5-10 to 5-15, programmed to [Speed up] or [Speed down].



NB!

If [Freeze output] is active, the frequency converter can only be stopped by the following:

- Bit 03 Coasting stop
- Bit 02 DC braking
- Digital input (par. 5-10 to 5-15) programmed to DC braking, Coasting stop or Reset and coasting stop.

Bit 06, Ramp stop/start:

Bit 06 set to [0] causes a stop, in which the motor speed is ramped down to stop via the selected ramp down parameter.

Bit 06 set to [1] permits the frequency converter to start the motor, if other starting conditions have been fulfilled.



NB!

In par. 8-53 *Start Select*, a selection is made to define how Bit 06 Ramp stop/start gates with the corresponding function on a digital input.

Bit 07, Reset:

Bit 07 set to [0] means no reset.

Bit 07 set to [1] resets a trip. Reset is activated on the leading edge of the signal, i.e. when changing from logic '0' to logic '1'.

Bit 08, Jog:

Bit 08 set to [1] causes the output frequency to be determined by par. 3-19 *Jog Speed*.

Bit 09, Selection of ramp '1/2':

Bit 09 set to [0] means that ramp 1 is active (par. 3-40 to 3-47).

Bit 09 set to [1] means that ramp 2 (par. 3-50 to 3-57) is active.

Bit 10, Data not valid / Data valid:

This bit tells the frequency converter whether the control word is to be used or ignored. Bit 10 set to [0] causes the control word to be ignored.

Bit 10 set to [1] causes the control word to be used.

The control word is always contained in the telegram, regardless of which type of telegram is used, so this function is useful for 'turning off' the control word when not required for updating or for reading parameters.

Bit 11, Relay 01:

Bit 11 set to [0] means that Relay is not activated.

Bit 11 set to [1] activates Relay 01, provided *Control word bit 11* [36] has been chosen in par. 5-40 *Function Relay*.

Bit 12, Relay 04:

Bit 12 set to [0] means that Relay 04 has not been activated.

Bit 12 set to [1] activates Relay 04, provided *Control word bit 12* [37] has been chosen in par. 5-40 *Function relay*.

Bit 13 and 14, Selection of set-up:

Bits 13 and 14 are used to select one of four menu set-ups according to the following table:

| Set-up | Bit 14 | Bit 13 |
|--------|--------|--------|
| 1 | 0 | 0 |
| 2 | 0 | 1 |
| 3 | 1 | 0 |
| 4 | 1 | 1 |

The function is only possible when Multi-Set-up [9] is selected in par. 0-10 *Active Set-up*.



NB!
In par. 8-55 *Set-up Select*, a selection is made to define how Bit 13/14 gates with the corresponding function on the digital inputs.

Bit 15, Reverse:

Bit 15 set to [0] causes no reversing.

Bit 15 set to [1] causes reversing.

Note: Par. 4-10 *Motor Speed Direction* determines if reversing is possible.

6.2.3. Status Word According to FC Profile (STW)

Parameter 8-10 set to [FC profile]

| Bit | Bit value=0 | Bit value=1 |
|-----|------------------------|--------------------------|
| 00 | Control not ready | Control ready |
| 01 | Drive not ready | Drive ready |
| 02 | Coasting | Enable |
| 03 | No error | Trip |
| 04 | No error | Error (no trip) |
| 05 | Reserved | - |
| 06 | No error | Trip lock |
| 07 | No warning | Warning |
| 08 | Speed # reference | Speed = reference |
| 09 | Local operation | Bus control |
| 10 | Out of frequency limit | Frequency limit ok |
| 11 | No operation | In operation |
| 12 | Brake ok | Brake warning or failure |
| 13 | Voltage ok | Voltage exceeded |
| 14 | Torque ok | Torque exceeded |
| 15 | Timer ok | Timer exceeded |

6.2.4. Explanation of the Status Bits

Bit 00, Control not ready / ready:

Bit 00 set to [0] means that the frequency converter has tripped.

Bit 00 set to [1] means that the frequency converter controls are ready, but that the power component is not necessarily receiving any power supply (in the event of external 24 V supply to controls).

Bit 01, Drive ready:

Bit 01 set to [1] means that the frequency converter is ready for operation, but it is receiving an active coasting command via the digital inputs or via serial communication.

Bit 02, Coasting stop:

Bit 02 set to [0] means that the frequency converter has released the motor.

Bit 02 set to [1] means that the frequency converter can start the motor when a start command is given.

Bit 03, No error / trip:

Bit 03 set to [0] means that the frequency converter is not in fault mode.

Bit 03 set to [1] means that the frequency converter is tripped and that a reset signal is required to re-establish operation.

Bit 04, No error / error (no trip):

Bit 04 set to [0] means that the frequency converter is not in fault mode.

Bit 04 set to [1] means that there is a frequency converter error but no trip.

Bit 05, Not used:

Bit 05 is not used in the status word.

Bit 06, No error / trip lock:

Bit 06 set to [0] means that the frequency converter is not in fault mode.

Bit 06 set to [1] means that the frequency converter is tripped and locked.

Bit 07, No warning / warning:

Bit 07 set to [0] means that there are no warnings.

Bit 07 set to [1] means that a warning has occurred.

Bit 08, Speed # reference / speed = reference:

Bit 08 set to [0] means that the motor is running, but that the present speed is different from the preset speed reference. For example, this might occur while the speed is being ramped up/down during start/stop.

Bit 08 set to [1] means that the present motor speed matches the preset speed reference.

Bit 09, Local operation / bus control:

Bit 09 set to [0] means that [STOP/RESET] is activated on the control unit or that Local [2] control in par. 3-13 *Reference Site* is selected. It is not possible to control the frequency converter via serial communication.

Bit 09 set to [1] means that it is possible to control the frequency converter via the fieldbus / serial communication interface.

Bit 10, Out of frequency limit:

Bit 10 set to [0] enables the output frequency to reach the value in par. 4-11 *Motor Speed Low Limit* or par. 4-13 *Motor Speed High Limit*.

Bit 10 set to [1] means that the output frequency is within the defined limits.

Bit 11, No operation / in operation:

Bit 11 set to [0] means that the motor is not running.

Bit 11 set to [1] means that the frequency converter has received a start signal or that the output frequency is greater than 0 Hz.

Bit 12, Brake OK / Brake warning or failure:

Bit 12 = [0] means that there is no brake warning or failure present.

Bit 12 = [1] means that the drive has stopped because of a brake warning or failure.

Bit 13, Voltage OK / limit exceeded:

Bit 13 set to [0] means that there are no voltage warnings.

Bit 13 set to [1] means that the DC voltage in the frequency converter's intermediate circuit is too low or too high.

Bit 14, Torque OK / limit exceeded:

Bit 14 set to [0] means that the motor current is lower than the torque limit selected in par. 4-18 *Current Limit*.

Bit 14 set to [1] means that the torque limit in par. 4-18 *Current Limit* has been exceeded.

Bit 15, Timer OK / limit exceeded:

Bit 15 = [0] means that the timers for motor thermal protection and VLT thermal protection, respectively, have not exceeded 100%.

Bit 15 = [1] means that one of the timers has exceeded 100%.

7. How to access FC 100 parameters

7.1. User-defined Network Variables UNVT

7.1.1. UNVT Parameter structure

Two special User-defined Network Variables (UNVT) have been defined to enable access to FC 100 parameters via LonWorks:

| Variable name: | UNVT type: |
|------------------|---------------------|
| nviParamRequest | UNVT_param_request |
| nvoParamResponse | UNVT_param_response |

The parameter- or attribute request has the following structure:

| UNVT_param_request | | | |
|--------------------|-----------------------------------|---------------|---------|
| Field | Range | Type | Size |
| Request | 1 = Read value 2 = Write value | Enum | 1 byte |
| Par_number | Parameter number | Unsigned long | 2 bytes |
| Subindex | Subindex (0-255) | Unsigned | 1 byte |
| Value | Parameter value | Unsigned quad | 4 bytes |

The parameter- or attribute response has the following structure:

| UNVT_param_response | | | |
|---------------------|---|---------------|------------|
| Field | Range | Type | Size |
| Response | 0 = Error response 1 = Read response 2 = Write response | Enum | 1 byte |
| Par_number | Parameter number | Unsigned long | 2 bytes |
| Length | Length of "value" field (0-27) | Unsigned | 1 byte |
| Value | Parameter or parameter attribute value | Unsigned | 0-27 bytes |

If an incorrect Read or Write request is encountered, an error message will be returned in the [Value] field, byte 0 and byte 3.

| Error description: | Error code in Value [0]: | Error code in Value [3]: |
|--------------------------|--------------------------|--------------------------|
| Invalid request type | 0xFF | 1 |
| Invalid parameter number | 0xFF | 2 |
| Invalid data type | 0xFF | 3 |
| No write access | 0xFF | 4 |
| Exceed limits | 0xFF | 5 |
| Invalid subindex | 0xFF | 6 |
| Not array | 0xFF | 7 |
| Only reset | 0xFF | 8 |
| Not changeable | 0xFF | 9 |
| Not in this mode | 0xFF | 10 |
| No bus access | 0xFF | 11 |
| Other error | 0xFF | 0xFE |

7.1.2. UNVT examples

Example: Read parameter 3-41

Ramp 1 Ramp-up Time

In the LonMaker browser, select the nviParamRequest and choose [Details].

| Subsystem | Device | Functional Block | Network Variable | Config Prop | Mon | Value |
|-------------|--------|------------------|------------------|---------------|-----|---------------------------------|
| Subsystem 1 | FC102 | Danfoss | | SCPTobjMajVer | N | 1 |
| Subsystem 1 | FC102 | Danfoss | | SCPTobjMinVer | N | 0 |
| Subsystem 1 | FC102 | Danfoss | nviAnOut1 | | N | 0,000 |
| Subsystem 1 | FC102 | Danfoss | nviControlword | | N | 0,0,0,0,0,0,0,0,0,0,0,0,0,0,0,0 |
| Subsystem 1 | FC102 | Danfoss | nviDigiOutput | | N | 0 0 0 0 0 0 0 0 0 0 0 0 0 0 0 0 |
| Subsystem 1 | FC102 | Danfoss | nviFeedback1 | | N | 0,000 |
| Subsystem 1 | FC102 | Danfoss | nviFeedback2 | | N | 0,000 |
| Subsystem 1 | FC102 | Danfoss | nviFeedback3 | | N | 0,000 |
| Subsystem 1 | FC102 | Danfoss | nviGpAnOut1 | | N | 0,0 |
| Subsystem 1 | FC102 | Danfoss | nviParamRequest | | N | NO REQUEST 0 0 0 0 0 0 |
| Subsystem 1 | FC102 | Danfoss | nviRefHz | | N | 0,000 |
| Subsystem 1 | FC102 | Danfoss | nviRefPcnt | | N | 0,000 |
| Subsystem 1 | FC102 | Danfoss | nviResetFault | | N | 0,000 |
| Subsystem 1 | FC102 | Danfoss | nviSetpoint1 | | N | 0,000 |
| Subsystem 1 | FC102 | Danfoss | nviSetpoint2 | | N | 0,000 |
| Subsystem 1 | FC102 | Danfoss | nviSetpoint3 | | N | 0,000 |
| Subsystem 1 | FC102 | Danfoss | nviStartStop | | N | 0,000 |
| Subsystem 1 | FC102 | Danfoss | nviTimeStamp | | N | 0,000 |
| Subsystem 1 | FC102 | Danfoss | nvoAlarm | | N | 0,000 |
| Subsystem 1 | FC102 | Danfoss | nvoAlarmword | | N | 0 0 0 0 0 0 |
| Subsystem 1 | FC102 | Danfoss | nvoAnIn1 | | N | 0,000 |
| Subsystem 1 | FC102 | Danfoss | nvoAnIn2 | | N | 0,000 |
| Subsystem 1 | FC102 | Danfoss | nvoBrokenBelt | | N | 0,000 |
| Subsystem 1 | FC102 | Danfoss | nvoDCVolt | | N | 566,0 |
| Subsystem 1 | FC102 | Danfoss | nvoDigitInput | | N | 0,0,0,0,0,0,0,0,0,0,0,0,0,0,0,0 |

In the bottom window, select the function [READ_VALUE].

Object Name: Subsystem 1/FC102/Danfoss/nviParamRequest

Object Value: NO_REQUEST 0 0 0 0 0 0

Field List:

- UNVT_param_request
 - request
 - NO_REQUEST
 - par_number
 - 0
 - subindex
 - 0
 - value[0]
 - 0
 - value[1]
 - 0
 - value[2]
 - 0
 - value[3]
 - 0

MEM_NULL

NO_REQUEST

READ_VALUE

WRITE_VALUE

7

In the [Field List:] under the section [par_number], enter the parameter number (in this example 3-41). If an indexed (array) parameter is accessed, the [subindex] field must be filled-in.

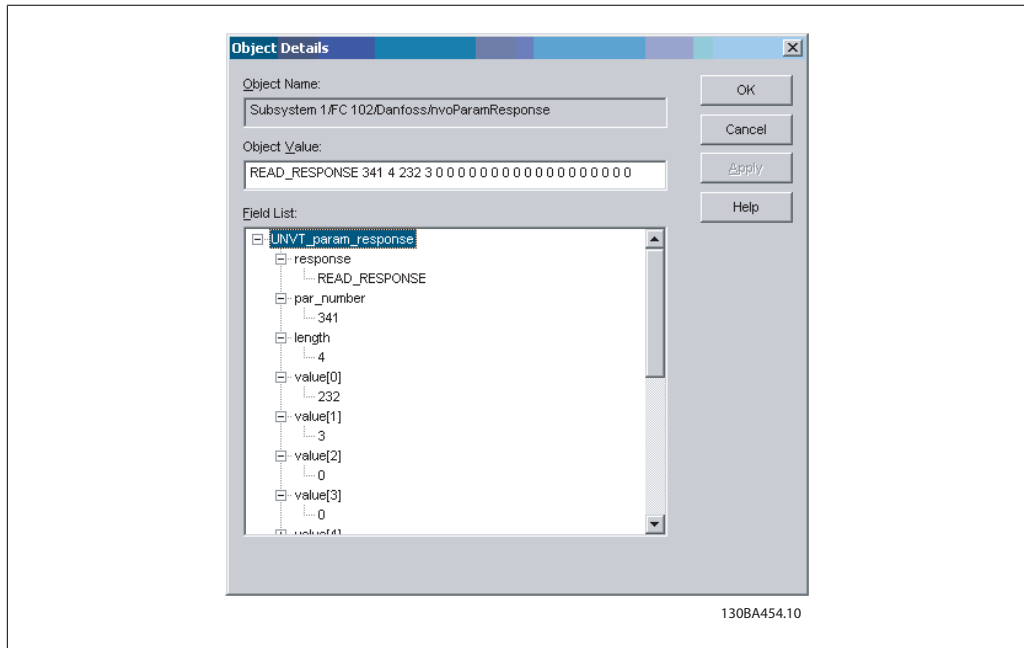

7

The response may look like this:

Value [0] (1st byte) = 232

Value [1] (2nd byte) = 3

-meaning that the readout value of parameter 3-41 is: $232+(3 \times 256) = 1000$

Conversion index of par. 3-41 is: $-2(0.01)$

Ramp 1 Ramp-up Time = $1000 \times 0.01 = \underline{10 \text{ seconds}}$

8. Parameters

8.1. Parameter list

8.1.1. Parameter list

| Par. No. | Parameter name: | Default value: | Range: | Conversion type: | Data type: |
|----------|-------------------------------|---------------------------|-------------|------------------|------------|
| 8-01 | Control Site | Dig. and control word [0] | [0 - 2] | - | 5 |
| 8-02 | Control Word Source | FC Port [1] | [0 - 4] | - | 5 |
| 8-03 | Control Word Timeout Time | 600 s | 0.1 - 18000 | 1 | 7 |
| 8-04 | Control Word Timeout Function | Off [0] | [0 - 10] | - | 5 |
| 8-05 | End-of-timeout Function | Hold set-up [0] | [0 - 1] | - | 5 |
| 8-06 | Reset Control Word Timeout | Do not reset [0] | [0 - 1] | - | 5 |
| 8-07 | Diagnosis Trigger | Disable [0] | [0 - 3] | - | 5 |
| 8-10 | Control Word Profile | FC profile [0] | [0 - x] | - | 5 |
| 8-50 | Coasting Select | Logic OR [3] | [0 - 3] | - | 5 |
| 8-52 | DC Brake Select | Logic OR [3] | [0 - 3] | - | 5 |
| 8-53 | Start Select | Logic OR [3] | [0 - 3] | - | 5 |
| 8-54 | Reversing Select | Logic OR [3] | [0 - 3] | - | 5 |
| 8-55 | Set-up Select | Logic OR [3] | [0 - 3] | - | 5 |
| 8-56 | Preset Reference Select | Logic OR [3] | [0 - 3] | - | 5 |
| 11-00 | Neuron ID | 00 00 00 00 00 00 | - | - | 10 |
| 11-10 | Drive Profile | VSD 6010 [0] | - | - | 5 |
| 11-15 | Lon Warning Word | 0 | - | - | 6 |
| 11-18 | LonWorks Revision | [0, 10] | - | - | 9 |
| 11-21 | Store Data Values | Off [0] | [0 - 1] | - | 5 |

8.2. Parameter Group 8

8-01 Control Site

| Option: | Function: |
|------------------------------|---|
| [0] * Digital and ctrl. word | Control by using both digital input and control word. |
| [1] Digital only | Control by using digital inputs only. |
| [2] Control word only | Control by using control word only. |

The setting in this parameter overrides the settings in par. 8-50 to 8-56.

8-02 Control Word Source

| Option: | Function: |
|-------------|-----------|
| [0] None | |
| [1] FC Port | |

- [2] FC USB
- [3] Option A
- [4] Option B
- [5] Option C0
- [6] Option C1

Select the source of the control word: one of two serial interfaces or four installed options. During initial power-up, the frequency converter automatically sets this parameter to *Option A* [3] if it detects a valid fieldbus option installed in slot A. If the option is removed, the frequency converter detects a change in the configuration, sets par. 8-02 back to default setting *FC Port*, and the frequency converter then trips. If an option is installed after initial power-up, the setting of par. 8-02 will not change but the frequency converter will trip and display: Alarm 67 *Option Changed*.

This parameter cannot be adjusted while the motor is running.

8-03 Control Timeout Time

Range:

0 s* [0.1 - 18000 s]

Function:

Enter the maximum time expected to pass between the reception of two consecutive telegrams. If this time is exceeded, it indicates that the serial communication has stopped. The function selected in par. 8-04 *Control Time-out Function* will then be carried out.

In LonWorks the following variables will trigger the Control Word Time parameter:

nviStartStop
 nviReset Fault
 nviControlWord
 nviDrvSpeedStpt
 nviRefPcnt
 nviRefHz

8-04 Control Timeout Function

Option:

- [0] * Off
- [1] Freeze output
- [2] Stop
- [3] Jogging
- [4] Max. Speed
- [5] Stop and trip
- [7] Select set-up 1
- [8] Select set-up 2
- [9] Select set-up 3
- [10] Select set-up 4
- [20] N2 Override Release

Function:

Select the time-out function. The time-out function activates when the control word fails to be updated within the time period specified in par. 8-03 *Control Time-out Time*.

Choice [20] only appears after setting the N2 protocol.

In LonWorks the time-out function also activates, when the following SNVT's fail to be updated within the time period specified in par. 8-03 *Control Time-out Time*.

nviStartStop
nviReset Fault
nviControlWord
nviDrvSpeedStpt
nviRefPcnt
nviRefHz

8-05 End-of-Timeout Function

| Option: | Function: |
|---------------------|---|
| [0] Hold set-up | Retains the set-up selected in par. 8-04 and displays a warning, until par. 8-06 toggles. Then the frequency converter resumes its original set-up. |
| [1] * Resume set-up | Resumes the set-up active prior to the time-out. |

Select the action after receiving a valid control word following a time-out. This parameter is active only when par. 8-04 is set to [Set-up 1-4].

8-06 Reset Control Timeout

| Option: | Function: |
|--------------------|---|
| [0] * Do not reset | Retains the set-up specified in par. 8-04, [Select setup 1-4] following a control time-out. |
| [1] Do reset | Returns the frequency converter to the original set-up following a control word time-out. When the value is set to <i>Do reset</i> [1], the frequency converter performs the reset and then immediately reverts to the <i>Do not reset</i> [0] setting. |

This parameter is active only when the choice *Hold set-up* [0] has been selected in par. 8-05 *End-of-Time-out Function*.

8-07 Diagnosis Trigger

| Option: | Function: |
|--------------------------|-----------|
| [0] * Disable | |
| [1] Trigger on alarms | |
| [2] Trigger alarms/warn. | |

This parameter has no function for LonWorks.

8-10 Control Word Profile

| Option: | Function: |
|------------------|---|
| [0] * FC profile | Select the interpretation of the control and status words corresponding to the installed fieldbus. Only the selections valid for the fieldbus installed in slot A will be visible in the LCP display. |

8-50 Coasting Select

| Option: | Function: |
|-------------------|---|
| [0] Digital input | Select control of the coasting function via the terminals (digital input) and/or via the bus. |
| [1] Bus | |
| [2] Logic AND | |
| [3] * Logic OR | |

 **NB!**
 This parameter is active only when *par. 8-01 Control Site* is set to [0] *Digital and control word*.

8-52 DC Brake Select

| Option: | Function: |
|-------------------|---|
| [0] Digital input | Select control of the DC brake via the terminals (digital input) and/or via the fieldbus. |
| [1] Bus | |
| [2] Logic AND | |
| [3] * Logic OR | |

 **NB!**
 This parameter is active only when *par. 8-01 Control Site* is set to [0] *Digital and control word*.

8-53 Start Select

| Option: | Function: |
|-------------------|---|
| [0] Digital input | Activates Start command via the serial communication port or fieldbus option. |
| [1] Bus | |
| [2] Logic AND | |
| [3] * Logic OR | |

Activates Start command via the fieldbus/serial communication port, AND additionally via one of the digital inputs.

Activates Start command via the fieldbus/serial communication port OR via one of the digital inputs.

Select control of the frequency converter start function via the terminals (digital input) and/or via the fieldbus.

**NB!**

This parameter is active only when *par. 8-01 Control Site* is set to [0] *Digital and control word*.

8-54 Reversing Select

| Option: | Function: |
|---------------------|---|
| [0] * Digital input | |
| [1] Bus | Activates Reverse command via the serial communication port or fieldbus option. |
| [2] Logic AND | Activates Reverse command via the fieldbus/serial communication port, AND additionally via one of the digital inputs. |
| [3] Logic OR | Activates Reverse command via the fieldbus/serial communication port OR via one of the digital inputs. |

Select control of the frequency converter reverse function via the terminals (digital input) and/or via the fieldbus.

**NB!**

This parameter is active only when *par. 8-01 Control Site* is set to [0] *Digital and control word*.

8-55 Set-up Select

| Option: | Function: |
|-------------------|--|
| [0] Digital input | |
| [1] Bus | Activates the set-up selection via the serial communication port or fieldbus option. |
| [2] Logic AND | Activates the set-up selection via the fieldbus/serial communication port, AND additionally via one of the digital inputs. |
| [3] * Logic OR | Activate the set-up selection via the fieldbus/serial communication port OR via one of the digital inputs. |

Select control of the frequency converter set-up selection via the terminals (digital input) and/or via the fieldbus.

**NB!**

This parameter is active only when *par. 8-01 Control Site* is set to [0] *Digital and control word*.

8-56 Preset Reference Select

| Option: | Function: |
|-------------------|-----------|
| [0] Digital input | |

| | | |
|-------|-----------|--|
| [1] | Bus | Activates Preset Reference selection via the serial communication port or fieldbus option. |
| [2] | Logic AND | Activates Preset Reference selection via the fieldbus/serial communication port, AND additionally via one of the digital inputs. |
| [3] * | Logic OR | Activates the Preset Reference selection via the fieldbus/serial communication port OR via one of the digital inputs. Select control of the frequency converter Preset Reference selection via the terminals (digital input) and/or via the fieldbus. |

**NB!**

This parameter is active only when *par. 8-01 Control Site* is set to [0] *Digital and control word*.

8.3. Parameter Group 11

11-00 Neuron ID

Option:**Function:**

View the Neuron chip's unique Neuron ID number.

11-10 Drive Profile

Option:**Function:**

[0] * VSD Profile

This parameter allows selecting between LONMARK Functional Profiles.
The Danfoss Profile and the Node Object are common for all profiles.

11-15 LON Warning Word

Range:**Function:**

0* [0 - FFFF]

This parameter contains the LON specific warnings.

| Bit | Status |
|-----|-------------------------------------|
| 0 | Internal fault |
| 1 | Internal fault |
| 2 | Internal fault |
| 3 | Internal fault |
| 4 | Internal fault |
| 5 | Invalid type change for nvoAnIn1 |
| 6 | Invalid type change for nvoAnIn2 |
| 7 | Invalid type change for nvo109AnIn1 |
| 8 | Invalid type change for nvo109AnIn2 |
| 9 | Invalid type change for nvo109AnIn3 |
| 10 | Initialization error |
| 11 | Internal communication error |
| 12 | Software revision mismatch |
| 13 | Bus not active |
| 14 | Option not present |
| 15 | LON input (nvi/nci) exceeds limits |

11-17 XIF Revision

0* [0 - 0]

Read only.

This parameter contains the version of the external interface file on the Neuron C chip on the LON option.

11-18 LonWorks Revision

0* [0 - 0]

Read only.

This parameter contains the software version of the application program on the Neuron C chip on the LON option.

11-21 Store Data Values

Option:

[0] * Off

Function:

Store function is inactive.

[2] Store All Set-ups

Stores all parameter values in the E²PROM. The value returns to *Off* when all parameter values have been stored.

This parameter is used to activate storing of data in non-volatile memory.

8.4. Data Types Supported by FC 100

8.4.1. Object and Data Types Supported by FC 100

| Data type: | Description: |
|------------|-----------------------------|
| 3 | Integer 16 |
| 4 | Integer 32 |
| 5 | Unsigned 8 |
| 6 | Unsigned 16 |
| 7 | Unsigned 32 |
| 9 | Visible string |
| 10 | Byte string |
| 33 | Standardized value (16 bit) |
| 35 | Bit sequence |
| 41 | Byte |
| 42 | Word |

8.4.2. Conversion Index

This number refers to a conversion figure used when writing or reading to parameters.

| Conversion dex: | in- Conversion factor: |
|-----------------|------------------------|
| 100 | 1 |
| 67 | 1 / 60 |
| 6 | 1000000 |
| 5 | 100000 |
| 4 | 10000 |
| 3 | 1000 |
| 2 | 100 |
| 1 | 10 |
| 0 | 1 |
| -1 | 0.1 |
| -2 | 0.01 |
| -3 | 0.001 |
| -4 | 0.0001 |
| -5 | 0.00001 |
| -6 | 0.000001 |

9. Troubleshooting

9.1. Alarm Word and Warning Word

9.1.1. Alarm and warning messages

General

There is a clear distinction between alarms and warnings. In the event of an alarm, the frequency converter will enter a fault condition. After the cause for the alarm has been cleared, the master must acknowledge the alarm message in order to start operation of the frequency converter again. A warning, on the other hand, may appear when a warning condition arises, then disappear when conditions return to normal without interfering with the process.

Alarm word and warning word are shown on the display in Hex format. If there is more than one warning or alarm, a sum of all warnings or alarms will be shown. Warning word and alarm word are displayed in par. 16-90 to 16-95. For more information on the individual alarms and warnings, please refer to: *VLT® HVAC Drive Design Guide*.

Warnings

All warnings within the frequency converter are represented by a single bit within a warning word. A warning word is always an action parameter. Bit status FALSE [0] means no warning, while bit status TRUE [1] means warning. Each bit status has a corresponding text string message. In addition to the warning word message the master will also be notified via a change to bit 7 in the status word.

Alarms

Following an alarm message the frequency converter will enter a fault condition. Only after the fault has been rectified and the master has acknowledged the alarm message by setting bit 3 in the Control Word, can the VLT resume operation. All alarms within the VLT are represented by a single bit within an alarm word. An alarm word is always an action parameter. Bit status FALSE [0] means no alarm, while bit status TRUE [1] means alarm.

9.1.2. Alarm words

Alarm word, 16-90

| Bit (Hex) | Alarm Word (Par. 16-90) |
|-----------|------------------------------|
| 00000001 | Brake check |
| 00000002 | Power card over temperature |
| 00000004 | Earth fault |
| 00000008 | Ctrl. card over temperature |
| 00000010 | Control word time-out |
| 00000020 | Over current |
| 00000040 | Torque limit |
| 00000080 | Motor thermistor over temp. |
| 00000100 | Motor ETR over temperature |
| 00000200 | Inverter overloaded |
| 00000400 | DC link under voltage |
| 00000800 | DC link over voltage |
| 00001000 | Short circuit |
| 00002000 | Inrush fault |
| 00004000 | Mains phase loss |
| 00008000 | AMA not OK |
| 00010000 | Live zero error |
| 00020000 | Internal fault |
| 00040000 | Brake overload |
| 00080000 | Motor phase U is missing |
| 00100000 | Motor phase V is missing |
| 00200000 | Motor phase W is missing |
| 00400000 | Fieldbus fault |
| 00800000 | 24V supply fault |
| 01000000 | Mains failure |
| 02000000 | 1.8V supply fault |
| 04000000 | Brake resistor short circuit |
| 08000000 | Brake chopper fault |
| 10000000 | Option change |
| 20000000 | Drive initialized |
| 40000000 | Safe Stop |
| 80000000 | Not used |

Alarm word 2, 16-91

| Bit (Hex) | Alarm Word 2 (Par. 16-91) |
|-----------|------------------------------------|
| 00000001 | Service Trip, read / Write |
| 00000002 | Reserved |
| 00000004 | Service Trip, Typecode / Sparepart |
| 00000008 | Reserved |
| 00000010 | Reserved |
| 00000020 | No Flow |
| 00000040 | Dry Pump |
| 00000080 | End of Curve |
| 00000100 | Broken Belt |
| 00000200 | Not used |
| 00000400 | Not used |
| 00000800 | Reserved |
| 00001000 | Reserved |
| 00002000 | Reserved |
| 00004000 | Reserved |
| 00008000 | Reserved |
| 00010000 | Reserved |
| 00020000 | Not used |
| 00040000 | Fans error |
| 00080000 | ECB error |
| 00100000 | Reserved |
| 00200000 | Reserved |
| 00400000 | Reserved |
| 00800000 | Reserved |
| 01000000 | Reserved |
| 02000000 | Reserved |
| 04000000 | Reserved |
| 08000000 | Reserved |
| 10000000 | Reserved |
| 20000000 | Reserved |
| 40000000 | Reserved |
| 80000000 | Reserved |

9.1.3. Warning words

Warning word, 16-92

| Bit (Hex) | Warning Word (Par. 16-92) |
|-----------|------------------------------|
| 00000001 | Brake check |
| 00000002 | Power card over temperature |
| 00000004 | Earth fault |
| 00000008 | Ctrl. card over temperature |
| 00000010 | Control word time-out |
| 00000020 | Over current |
| 00000040 | Torque limit |
| 00000080 | Motor thermistor over temp. |
| 00000100 | Motor ETR over temperature |
| 00000200 | Inverter overloaded |
| 00000400 | DC link under voltage |
| 00000800 | DC link over voltage |
| 00001000 | DC link voltage low |
| 00002000 | DC link voltage high |
| 00004000 | Mains phase loss |
| 00008000 | No motor |
| 00010000 | Live zero error |
| 00020000 | 10V low |
| 00040000 | Brake resistor power limit |
| 00080000 | Brake resistor short circuit |
| 00100000 | Brake chopper fault |
| 00200000 | Speed limit |
| 00400000 | Fieldbus comm. fault |
| 00800000 | 24V supply fault |
| 01000000 | Mains failure |
| 02000000 | Current limit |
| 04000000 | Low temperature |
| 08000000 | Voltage limit |
| 10000000 | Encoder loss |
| 20000000 | Output frequency limit |
| 40000000 | Not used |
| 80000000 | Not used |

Warning word 2, 16-93

| Bit (Hex) | Warning Word 2 (Par. 16-93) |
|-----------|-----------------------------|
| 00000001 | Start Delayed |
| 00000002 | Stop Delayed |
| 00000004 | Clock Failure |
| 00000008 | Reserved |
| 00000010 | Reserved |
| 00000020 | No Flow |
| 00000040 | Dry Pump |
| 00000080 | End of Curve |
| 00000100 | Broken Belt |
| 00000200 | Not used |
| 00000400 | Reserved |
| 00000800 | Reserved |
| 00001000 | Reserved |
| 00002000 | Reserved |
| 00004000 | Reserved |
| 00008000 | Reserved |
| 00010000 | Reserved |
| 00020000 | Not used |
| 00040000 | Fans warning |
| 00080000 | ECB warning |
| 00100000 | Reserved |
| 00200000 | Reserved |
| 00400000 | Reserved |
| 00800000 | Reserved |
| 01000000 | Reserved |
| 02000000 | Reserved |
| 04000000 | Reserved |
| 08000000 | Reserved |
| 10000000 | Reserved |
| 20000000 | Reserved |
| 40000000 | Reserved |
| 80000000 | Reserved |

9.2. Extended Status Word

9.2.1. Extended status words

Extended status word, 16-94

| Bit (Hex) | Extended Status Word (Par. 16-94) |
|-----------|-----------------------------------|
| 00000001 | Ramping |
| 00000002 | AMA tuning |
| 00000004 | Start CW/CCW |
| 00000008 | Not used |
| 00000010 | Not used |
| 00000020 | Feedback high |
| 00000040 | Feedback low |
| 00000080 | Output current high |
| 00000100 | Output current low |
| 00000200 | Output frequency high |
| 00000400 | Output frequency low |
| 00000800 | Brake check OK |
| 00001000 | Braking max |
| 00002000 | Braking |
| 00004000 | Out of speed range |
| 00008000 | OVC active |
| 00010000 | AC brake |
| 00020000 | Password Timelock |
| 00040000 | Password Protection |
| 00080000 | Reference high |
| 00100000 | Reference low |
| 00200000 | Local Ref./Remote Ref. |
| 00400000 | Reserved |
| 00800000 | Reserved |
| 01000000 | Reserved |
| 02000000 | Reserved |
| 04000000 | Reserved |
| 08000000 | Reserved |
| 10000000 | Reserved |
| 20000000 | Reserved |
| 40000000 | Reserved |
| 80000000 | Reserved |

Extended status word 2, 16-95

| Bit (Hex) | Extended Status Word 2 (Par. 16-95) |
|-----------|-------------------------------------|
| 00000001 | Off |
| 00000002 | Hand / Auto |
| 00000004 | Not used |
| 00000008 | Not used |
| 00000010 | Not used |
| 00000020 | Relay 123 active |
| 00000040 | Start Prevented |
| 00000080 | Control ready |
| 00000100 | Drive ready |
| 00000200 | Quick Stop |
| 00000400 | DC Brake |
| 00000800 | Stop |
| 00001000 | Standby |
| 00002000 | Freeze Output Request |
| 00004000 | Freeze Output |
| 00008000 | Jog Request |
| 00010000 | Jog |
| 00020000 | Start Request |
| 00040000 | Start |
| 00080000 | Start Applied |
| 00100000 | Start Delay |
| 00200000 | Sleep |
| 00400000 | Sleep Boost |
| 00800000 | Running |
| 01000000 | Bypass |
| 02000000 | Fire Mode |
| 04000000 | Reserved |
| 08000000 | Reserved |
| 10000000 | Reserved |
| 20000000 | Reserved |
| 40000000 | Reserved |
| 80000000 | Reserved |

9.3. Reference Scaling

9.3.1. Reference Scaling

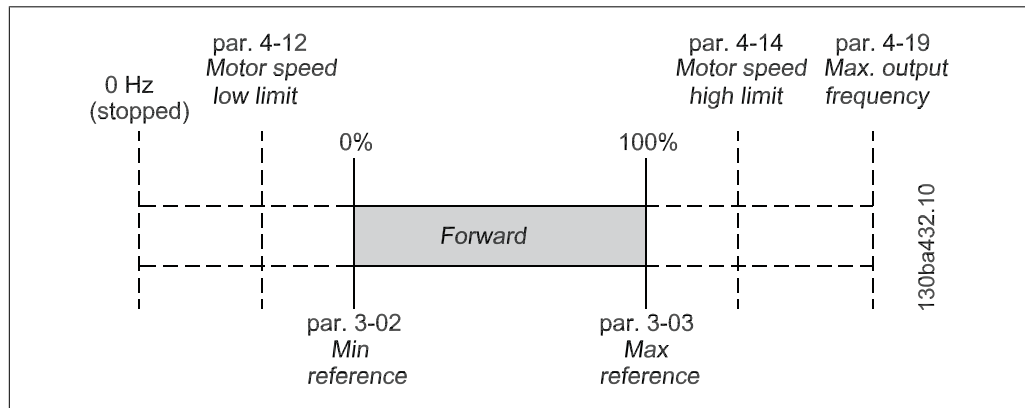

Example:

Par. 3-00 = [Min - Max]
 Par. 3-02 [Min reference] = 100 RPM
 Par. 3-03 [Max reference] = 1500 RPM
 Reference send = 1500 hex (5376 dec)

Output:

The output can be calculated as:

$$\frac{\text{Reference (decimal)} * (\text{par.3-03} - \text{par.3-02})}{16384} + \text{par.3-02} =$$

$$\frac{5376 * (1500 - 100)}{16384} + 100 = \mathbf{559 \text{ RPM}}$$

9.4. Network Variables - Overview

9.4.1. Output variables (nvo)

| Variable function | Variable name | SNVT type | Profile | FC 100 par. |
|-----------------------|------------------|------------------------|-----------|------------------|
| Status word | nvoStatusword | SNVT_state | FC VSD | 16-03 |
| Drive output [%] | nvoOutputPcnt | SNVT_lev_percent | FC VSD | 16-05 |
| Drive output [Hz] | nvoOutputHz | SNVT_freq_hz | FC VSD | 16-13 |
| kWh counter | nvoDrvEnrg | SNVT_elec_kwh_l | FC VSD | 15-02 |
| DC Link Voltage | nvoDCVoltage | SNVT_volt | FC VSD | 16-30 |
| Motor thermal | nvoTempMtr | SNVT_lev_cont | FC VSD | 16-18 |
| Inverter Thermal | nvoTempInvtrtr | SNVT_lev_cont | FC VSD | 16-35 |
| Closed loop feedback | nvoFeedback | SNVT_count_inc_f | FC VSD | 16-52 |
| Fanbelt broken | nvoBrokenBelt | SNVT_switch | FC VSD | 16-93 |
| Alarm flag | nvoAlarm | SNVT_switch | FC VSD | 16-90 |
| Warning flag | nvoWarning | SNVT_switch | FC VSD | 16-03 |
| Alarm word | nvoAlarmword | SNVT_state_64 | FC VSD | 16-90 + 16-91 |
| Warning word | nvoWarningword | SNVT_state_64 | FC VSD | 16-92 + 16-93 |
| Extended status-word | nvoExtendedStsw | SNVT_state_64 | FC VSD | 16-94 + 16-95 |
| Digital inputs | nvoDigitInput | SNVT_state_64 | FC VSD | 16-60 |
| Analog Input (53) | nvoAnIn1 | SNVT_volt/SNVT_amp_mil | FC VSD | 16-62 |
| Analog Input (54) | nvoAnIn2 | SNVT_volt/SNVT_amp_mil | FC VSD | 16-64 |
| Analog Input (X30/11) | nvo101AnIn1 | SNVT_volt | FC VSD | 16-75 |
| Analog Input (X30/12) | nvo101AnIn2 | SNVT_volt | FC VSD | 16-76 |
| Analog Input (X42/1) | nvo109AnIn1 | SNVT_volt/SNVT_temp_p | FC VSD | 18-30 |
| Analog Input (X42/3) | nvo109AnIn2 | SNVT_volt/SNVT_temp_p | FC VSD | 18-31 |
| Analog Input (X42/5) | nvo109AnIn3 | SNVT_volt/SNVT_temp_p | FC VSD | 18-32 |
| ECB option status | nvoECBstatus | SNVT_state | FC VSD | 31-10 |
| Parameter access cmd. | nvoParamResponse | UNVT_param_response | FC VSD | - |
| Drive Speed | nvoDrvSpeed | SNVT_lev_percent | VSD 6010 | 16-05 |
| Output current | nvoDrvCurnt | SNVT_amp | VSD 6010 | 16-14 |
| Output voltage | nvoDrvVolt | SNVT_volt | VSD 6010 | 16-12 |
| Output power | nvoDrvPwr | SNVT_power_kilo | VSD 6010 | 16-10 |
| Running hours | nvoDrvRunHours | SNVT_time_hour | VSD 6010 | 15-01 |
| Object Status | nvoStatus | SNVT_obj_status | Node obj. | - |

9.4.2. Input variables (nvi)

| Variable Function | Variable Name | SNVT type | Profile | FC 100 par. |
|--------------------------|------------------|--------------------|-----------|-----------------|
| Start/Stop | nviStartStop | SNVT_switch | FC VSD | CTW/reference |
| Control word | nviControlword | SNVT_state | FC VSD | CTW |
| Reset fault | nviResetFaut | SNVT_switch | FC VSD | CTW |
| Reference [%] | nviRefPcnt | SNVT_lev_percent | FC VSD | Reference |
| Reference [Hz] | nviRefHz | SNVT_freq_hz | FC VSD | Reference |
| CL Setpoint 1 | nviSetpoint1 | SNVT_lev_percent | FC VSD | 20-21 |
| CL Setpoint 2 | nviSetpoint2 | SNVT_lev_percent | FC VSD | 20-22 |
| CL Setpoint 3 | nviSetpoint3 | SNVT_lev_percent | FC VSD | 20-23 |
| Bus feedback 1 | nviFeedback1 | SNVT_lev_percent | FC VSD | 8-94 |
| Bus feedback 2 | nviFeedback2 | SNVT_lev_percent | FC VSD | 8-95 |
| Bus feedback 3 | nviFeedback3 | SNVT_lev_percent | FC VSD | 8-96 |
| Digital/relay outputs | nviDigiOutput | SNVT_state | FC VSD | 5-90 |
| Analog output (42) | nviAnOut1 | SNVT_lev_percent | FC VSD | 6-53 |
| Analog output (X30/8) | nvi101AnOut1 | SNVT_lev_percent | FC VSD | 6-63 |
| Analog output (X42/7) | nvi109AnOut1 | SNVT_lev_percent | FC VSD | 26-43 |
| Analog output (X42/9) | nvi109AnOut2 | SNVT_lev_percent | FC VSD | 26-53 |
| Analog output (X42/11) | nvi109AnOut3 | SNVT_lev_percent | FC VSD | 26-63 |
| Setting of RTC | nviTimeStamp | SNVT_time_stamp | FC VSD | 0-70 |
| ECB option Mode | nviECBMode | SNVT_state | FC VSD | 31-00 |
| ECB By-pass activation | nviECBActivation | SNVT_switch | FC VSD | 31-19 |
| Parameter access command | nviParamRequest | UNVT_param_request | FC VSD | - |
| Drive speed setpoint | nviDrvSpeedStpt | SNVT_switch | VSD 6010 | CTW / Reference |
| Standard Node Object | nviRequest | SNVT_obj_request | Node obj. | - |

9.4.3. Configuration properties (nci)

| Variable function | Variable name | SNVT type | Profile | FC 100 parameter |
|-------------------------------|-----------------|------------------|--------------|------------------|
| Max. motor speed [%] | nciMaxSpeed | SNVT_lev_percent | VSD 6010 | 4-13 |
| Min. motor speed [%] | nciMinSpeed | SNVT_lev_percent | VSD 6010 | 4-11 |
| Nom. motor speed [RPM] | nciNmlSpeed | SNVT_rpm | VSD 6010 | 1-25 |
| Nom. motor frequency [Hz] | nciNmlFreq | SNVT_freq_hz | VSD 6010 | 1-23 |
| Min. ramp-up time [s] | nciRampUpTime | SNVT_time_sec | VSD 6010 | 3-41 |
| Min. ramp-down time [s] | nciRampDownTime | SNVT_time_sec | VSD 6010 | 3-42 |
| Heartbeat time [s] | nciSndHrtBt | SNVT_time_sec | VSD 6010 | - |
| Max Send Time (Heartbeat) | nciMaxStsSendT | SNVT_elapsed_tm | Node obj. | - |
| Min Send Time (Inhibit timer) | nciMinSendT | SNVT_elapsed_tm | Virtual obj. | - |

Index

A

| | |
|----------------------------|----|
| Abbreviations | 9 |
| About This Manual | 7 |
| Alarm And Warning Messages | 61 |
| Alarm Flag | 30 |
| Alarm Word | 30 |
| Alarm Word, 16-90 | 62 |
| Analog Input (53) | 31 |
| Analog Input (54) | 32 |
| Analog Input (x30/11) | 32 |
| Analog Input (x30/12) | 32 |
| Analog Input (x42/1) | 32 |
| Analog Input (x42/3) | 33 |
| Analog Input (x42/5) | 33 |
| Analog Output (42) | 24 |
| Analog Output (x30 / 8) | 25 |
| Analog Output (x42 / 7) | 25 |
| Analog Output (x42 / 9) | 25 |
| Analog Output (x42 /11) | 25 |
| Assumptions | 7 |

B

| | |
|----------------------|----|
| Background Knowledge | 8 |
| Bus Feedback 1-3 | 23 |
| Bus Line | 13 |

C

| | |
|--------------------------------|----|
| Cable Lengths | 13 |
| Cabling | 11 |
| Closed Loop Feedback | 29 |
| Closed Loop Set-point 1-3 | 23 |
| Coasting Select, 8-50 | 56 |
| Configuration Properties (nci) | 67 |
| Configuration Properties (nci) | 36 |
| Configure The Lonworks Network | 19 |
| Control Site, 8-01 | 53 |
| Control Timeout Function, 8-04 | 54 |
| Control Timeout Time, 8-03 | 54 |
| Control Word | 22 |
| Control Word Profile, 8-10 | 55 |
| Control Word Time-out Function | 42 |
| Controlword Source, 8-02 | 53 |
| Conversion Index | 60 |

D

| | |
|-------------------------|----|
| Dc Brake Select, 8-52 | 56 |
| Dc Link Voltage [v] | 29 |
| Diagnosis Trigger, 8-07 | 55 |
| Digital / Relay Outputs | 24 |
| Digital Inputs | 31 |
| Drive Output [%] | 28 |
| Drive Output [hz] | 28 |
| Drive Profile, 11-10 | 58 |
| Drive Speed | 37 |

E

| | |
|-------------------------------|----|
| Ecb Option Mode | 26 |
| Ecb Option Status | 33 |
| Ecb Remote By-pass Activation | 26 |
| Emc Precautions | 13 |

| | |
|--|------------|
| End-of-timeout Function, 8-05 | 55 |
| Example: Read Parameter 3-41 | 50 |
| Explanation Of The Control Bits | 45 |
| Explanation Of The Status Bits | 47 |
| Extended Status Word | 31 |
| Extended Status Word 2, 16-95 | 64 |
| Extended Status Word, 16-94 | 64 |
| | |
| F | |
| Fanbelt Broken | 29 |
| Fc Control Profile | 44 |
| Fc Vsd Profile | 20 |
| Fc Vsd Profile - Input | 22 |
| Fieldbus Option | 16 |
| Frequency Converter Speed Setpoint | 37 |
| Functional Profiles | 19 |
| | |
| H | |
| Hardware | 8 |
| Heartbeat Time [s] | 40 |
| How To Install Option In Frequency Converter | 16 |
| | |
| I | |
| Input Variables | 20 |
| Input Variables | 35 |
| Input Variables (nvi) | 67 |
| Installation At High Altitudes | 5 |
| Inverter Thermal [%] | 29 |
| | |
| K | |
| Kwh Counter [kwh] | 28 |
| | |
| L | |
| Least Significant Bit (lsb) | 28, 30, 31 |
| Led Behaviour | 15 |
| Lon | 7, 0 |
| Lon Technology | 7, 0 |
| Lon Warning Word, 11-15 | 58 |
| Lonmark Certification | 8 |
| Lonworks Communication Structure | 0 |
| Lonworks Option | 11 |
| Lonworks Revision, 11-18 | 59 |
| | |
| M | |
| Max Motor Speed [%] | 39 |
| Max. Send Time (heartbeat) | 41 |
| Min Motor Speed [%] | 39 |
| Min Ramp-down Time [s] | 40 |
| Min Ramp-up Time [s] | 40 |
| Min. Send Time (inhibit Timer) | 42 |
| Motor Thermal [%] | 29 |
| | |
| N | |
| Network Termination | 12 |
| Network Variable Description | 22 |
| Neuron Id Label | 19 |
| Neuron Id, 11-00 | 58 |
| Node Object | 41 |
| Nom Motor Speed [rpm] | 39 |
| Nominal Motor Frequency [hz] | 39 |
| Non-volatile Memory | 36 |

O

| | |
|---|----|
| Object And Data Types Supported By Fc 100 | 60 |
| Object Request | 41 |
| Object Response | 41 |
| Output Current | 37 |
| Output Power | 38 |
| Output Variables | 21 |
| Output Variables | 35 |
| Output Variables (nvo) | 66 |
| Output Voltage | 37 |

P

| | |
|-------------------------------|----|
| Parameter Access Command | 26 |
| Parameter Access Response | 33 |
| Parameter List | 53 |
| Preset Reference Select, 8-56 | 57 |

Q

| | |
|----------------|----|
| Query And Wink | 19 |
|----------------|----|

R

| | |
|--|----|
| Reference [%] | 23 |
| Reference [hz] | 23 |
| Reference Handling | 43 |
| Reference Scaling | 65 |
| Related Literature For The Vlt® Hvac Drive | 8 |
| Reset Control Timeout, 8-06 | 55 |
| Reset Fault | 22 |
| Resource Files | 19 |
| Reversing Select, 8-54 | 57 |
| Running Hours | 38 |

S

| | |
|---|----|
| Safety Note | 5 |
| Safety Regulations | 5 |
| Service Pin | 19 |
| Setting Of Rtc | 26 |
| Start Select, 8-53 | 56 |
| Start/stop | 22 |
| Status Word | 28 |
| Status Word According To Fc Profile (stw) | 47 |
| Store Data Values, 11-21 | 59 |
| System Specifications | 13 |

T

| | |
|--------------------|---|
| Technical Overview | 7 |
|--------------------|---|

U

| | |
|--------------------------|----|
| Unvt Parameter Structure | 49 |
| Unvt_param_request | 49 |
| Unvt_param_response | 49 |

W

| | |
|----------------------------------|----|
| Warning Against Unintended Start | 5 |
| Warning Flag | 30 |
| Warning Word | 30 |
| Warning Word 2, 16-93 | 63 |
| Warning Word, 16-92 | 63 |

X

Xif Revision, 11-17

59