

■ Contents

Safety	3
Safety regulations	4
Warning against unintended start	5
Installation of mechanical brake	5
Quick Setup	6
Introduction	9
Available literature	9
Technical data	10
General technical data	10
Electrical data	16
Fuses	33
Mechanical dimensions	35
Installation	38
Mechanical installation	38
Safety earthing	41
Extra protection (RCD)	41
Electrical installation - mains supply	41
Electrical installation - motor cables	42
Connection of motor	42
Direction of motor rotation	42
Electrical installation - brake cable	43
Electrical installation - brake resistor temperature switch	43
Electrical installation - loadsharing	43
Electrical installation - 24 Volt external DC supply	45
Electrical installation - relay outputs	45
Electrical installation - control cables	53
Electrical installation - bus connection	56
Electrical installation - EMC precautions	57
Use of emc-correct cables	60
Electrical installation - earthing of control cables	61
RFI switch	62
Operation of the frequency converter	65
Control panel (LCP)	65
Control panel - display	65
Control panel - LEDs	65
Control panel - control keys	66
Quick Setup	68
Parameter selection	68
Menu mode	68
Initialisation to factory setting	70

Application configuration	72
Connection examples	72
Setting of parameters	74
Special functions	77
Local and remote control	77
Control with brake function	78
References - single references	79
References - multi-references	81
Automatic Motor Adaptation, AMA	85
Mechanical brake control	87
PID for process control	89
PID for speed control	90
Quick discharge	91
Flying start	93
Normal/high overload torque control, open loop	94
Programming of Torque limit and stop	94
Programming	96
Parameters - Operation and Display	96
Parameters - Load and motor	103
Parameters - References and limits	114
Parameters - Inputs and outputs	122
Parameters - Special functions	138
Parameters - Serial communication	152
Parameters - Technical functions and diagnostics	159
Miscellaneous	166
Trouble-shooting	166
Display - Status messages	167
Warnings and alarms	170
Warnings	171
Index	190

VLT 5000 Series
Operating Instructions
Software version: 3.9x



These Operating Instructions can be used for all VLT 5000 Series frequency converters with software version 3.9x.

The software version number can be seen from parameter 624.

CE and C-tick labelling do not cover VLT 5001-5062, 525-600 V units.

Safety

These Operating Instructions are a tool intended for persons who are to install, operate and program the VLT 5000 Series.

Operating Instructions: Gives instructions in optimum installation, commissioning and service.

Design Guide: Gives all required information for design purposes, and gives a good insight into the technology, product range, technical data, etc.

The Operating Instructions including Quick Setup are delivered with the unit.

When reading these Operating Instructions, you will come across different symbols that require special attention. The symbols used are the following:



Indicates a general warning



Indicates a high-voltage warning



NB!

Indicates something to be noted by the reader



The voltage of the frequency converter is dangerous whenever the equipment is connected to mains. Incorrect installation of the motor or the frequency converter may cause damage to the equipment, serious personal injury or death. Consequently, the instructions in this manual, as well as national and local rules and safety regulations, must be complied with.



Installation in high altitudes:
By altitudes above 2km, please contact Danfoss Drives regarding PELV

■ Safety regulations

1. The frequency converter must be disconnected from mains if repair work is to be carried out. Check that the mains supply has been disconnected and that the necessary time has passed before removing motor and mains plugs.
2. The [STOP/RESET] key on the control panel of the frequency converter does not disconnect the equipment from mains and is thus not to be used as a safety switch.
3. Correct protective earthing of the equipment must be established, the user must be protected against supply voltage, and the motor must be protected against overload in accordance with applicable national and local regulations.
4. The earth leakage currents are higher than 3.5 mA.
5. Protection against motor overload is not included in the factory setting. If this function is desired, set parameter 128 to data value *ETR trip* or data value *ETR warning*.
Note: The function is initialised at 1.16 x rated motor current and rated motor frequency. For the North American market: The ETR functions provide class 20 motor overload protection in accordance with NEC.
6. Do not remove the plugs for the motor and main supply while the frequency converter is connected to mains. Check that the mains supply has been disconnected and that the necessary time has expired before removing motor and mains plugs.
7. Please note that the frequency converter has more voltage inputs than L1, L2 and L3, when loadsharing (linking of DC intermediate circuit) and external 24 V DC have been installed. Check that all voltage inputs have been disconnected and that the necessary time has passed before repair work is commenced.

■ Warning against unintended start

1. The motor can be brought to a stop by means of digital commands, bus commands, references or a local stop, while the frequency converter is connected to mains. If personal safety considerations make it necessary to ensure that no unintended start occurs, these stop functions are not sufficient.
2. While parameters are being changed, the motor may start. Consequently, the stop key [STOP/RESET] must always be activated, following which data can be modified.
3. A motor that has been stopped may start if faults occur in the electronics of the frequency converter, or if a temporary overload or a fault in the supply mains or the motor connection ceases.

■ Installation of mechanical brake

Do not connect a mechanical brake to the output from the frequency converter before the relevant parameters for brake control are parameterised.

(Selection of output in parameter 319, 321, 323 or 326 and cut-in current and frequency in parameter 223 and 225).

■ Use on isolated mains

See section *RFI Switch* regarding use on isolated mains.

It is important to follow the recommendations regarding installation on IT-mains, since sufficient protection of the complete installation must be observed. Not taking care using relevant monitoring devices for IT-mains may result in damage.

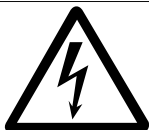

Warning:

Touching the electrical parts may be fatal - even after the equipment has been disconnected from mains. Also make sure that other voltage inputs have been disconnected, such as external 24 V DC, load-sharing (linkage of DC intermediate circuit), as well as the motor connection for kinetic back-up.

VLT 5001 - 5006, 200-240 V:	wait at least 4 minutes
VLT 5008 - 5052, 200-240 V:	wait at least 15 minutes
VLT 5001 - 5006, 380-500 V:	wait at least 4 minutes
VLT 5008 - 5062, 380-500 V:	wait at least 15 minutes
VLT 5072 - 5302, 380-500 V:	wait at least 20 minutes
VLT 5352 - 5552, 380-500 V:	wait at least 40 minutes
VLT 5001 - 5005, 525-600 V:	wait at least 4 minutes
VLT 5006 - 5022, 525-600 V:	wait at least 15 minutes
VLT 5027 - 5062, 525-600 V:	wait at least 30 minutes
VLT 5042 - 5352, 525-690 V:	wait at least 20 minutes
VLT 5402 - 5602, 525-690 V:	wait at least 30 minutes

■ Introduction to Quick Setup

This Quick Setup will guide you through EMC correct installation of the frequency converter by connecting power, motor and control wiring (fig. 1). Start/stop of motor is to be done with the switch.

For VLT 5122 - 5552 380 - 500 V, VLT 5032 - 5052 200 - 240 V AC and VLT 5042-5602, 525-690 V, please refer to *Technical data* and *Installation* regarding mechanical and electrical installation.

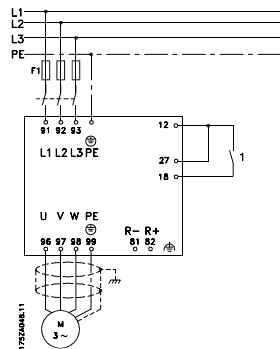

Fig. 1

■ 1. Mechanical Installation

VLT 5000 frequency converters allow side-by-side mounting. The necessary cooling demands a free air passage of 100 mm above and below the frequency converter (5016-5062 380-500 V, 5008-5027 200-240 V and 5016-5062 525-600 V must have 200 mm, 5072-5102, 380-500 V 225 mm).

Drill all holes by using the measurements stated in the table. Please note the difference in unit voltage. Place the frequency converter on the wall. Tighten up all four screws.

All the below listed measurements are in mm

VLT type	A	B	C	a	b
Bookstyle IP 20, 200–240 V, (Fig. 2)					
5001 - 5003	395	90	260	384	70
5004 - 5006	395	130	260	384	70
Bookstyle IP 20, 380–500 V (Fig. 2)					
5001 - 5005	395	90	260	384	70
5006 - 5011	395	130	260	384	70
Compact IP 54, 200–240 V (Fig. 3)					
5001 - 5003	460	282	195	260	258
5004 - 5006	530	282	195	330	258
5008 - 5011	810	350	280	560	326
5016 - 5027	940	400	280	690	375
Compact IP 54, 380–500 V (Fig. 3)					
5001 - 5005	460	282	195	260	258
5006 - 5011	530	282	195	330	258
5016 - 5027	810	350	280	560	326
5032 - 5062	940	400	280	690	375
5072 - 5102	940	400	360	690	375
Compact IP 20, 200–240 V (Fig. 4)					
5001 - 5003	395	220	160	384	200
5004 - 5006	395	220	200	384	200
5008	560	242	260	540	200
5011 - 5016	700	242	260	680	200
5022 - 5027	800	308	296	780	270
Compact IP 20, 380–500 V (Fig. 4)					
5001 - 5005	395	220	160	384	200
5006 - 5011	395	220	200	384	200
5016 - 5022	560	242	260	540	200
5027 - 5032	700	242	260	680	200
5042 - 5062	800	308	296	780	270
5072 - 5102	800	370	335	780	330

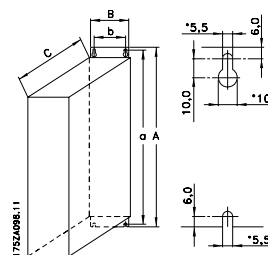

Fig. 2

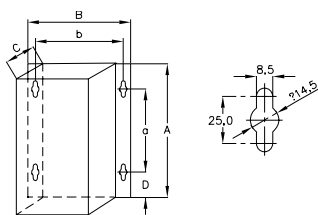

Fig. 3

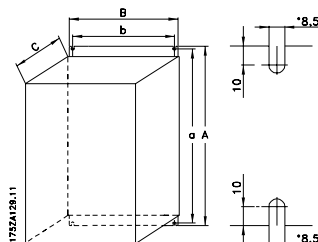
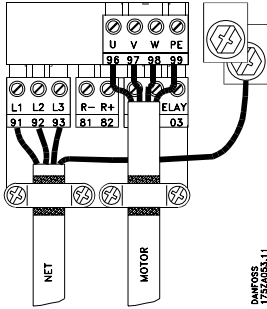

Fig. 4

2. Electrical Installation, power

NOTE: The terminals are detachable on VLT 5001 - 5006, 200 - 240 V, VLT 5001 - 5011, 380 - 500 V and VLT 5001 - 5011, 525 - 600 V

Connect the mains supply to the mains terminals L1, L2, L3 of the frequency converter and to the earth connection (fig. 5-8). Cable relief fitting is placed on the wall for Bookstyle units. Mount screened motor cable to the motor terminals U, V, W, PE of the frequency converter. Make sure, the screen is connected electrically to the drive.



DANFOSS 1752A053.1.1

Fig. 5
Bookstyle IP 20
 5001 - 5011 380 - 500 V
 5001 - 5006 200 - 240 V

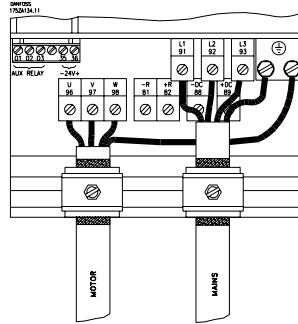
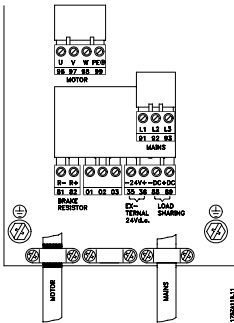

Fig. 7
Compact IP 20
 5016 - 5102 380 - 500 V
 5008 - 5027 200 - 240 V
 5016 - 5062 525 - 600 V



1752A051.1 **Fig. 6**

Compact IP 20 and IP 54
 5001 - 5011 380 - 500 V
 5001 - 5006 200 - 240 V
 5001 - 5011 525 - 600 V

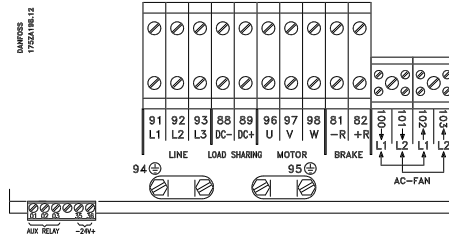

Fig. 8

Compact IP 54
 5016 - 5062 380 - 500 V
 5008 - 5027 200 - 240 V

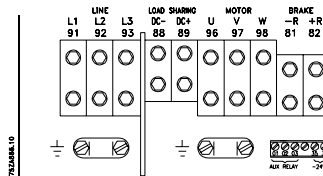

Fig. 9

Compact IP 54
 5072 - 5102 380 - 500 V

Quick Setup

■ **3. Electrical installation, control leads**

Use a screw driver to remove the front cover under the control panel.

NOTE: The terminals are detachable. Connect a jumper between terminals 12 and 27 (Fig. 10)

Mount screened cable to external start/stop of control terminals 12 and 18.

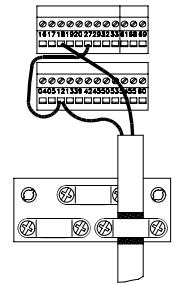

Fig. 10

■ **4. Programming**

The frequency converter is programmed over the control panel.

Press the QUICK MENU button. The Quick Menu appears in the display. You choose parameters by means of arrow up and arrow down. Press the CHANGE DATA button to change parameter value. Data values are changed using the up and down arrows. Press the left or right buttons to move the cursor. Press OK to save your parameter setting.

Set the desired language in parameter 001. You have six possibilities: English, German, French, Danish, Spanish and Italian.

Set the motor parameters according to the motorplate:

Motor power	Parameter 102
Motor voltage	Parameter 103
Motor frequency	Parameter 104
Motor current	Parameter 105
Rated motor speed	Parameter 106

Set frequency interval and ramp times (Fig. 11)

Min. reference	Parameter 204
Max. reference	Parameter 205
Ramp up time	Parameter 207
Ramp down time	Parameter 208

Set Operation site, *Parameter 002* for Local.

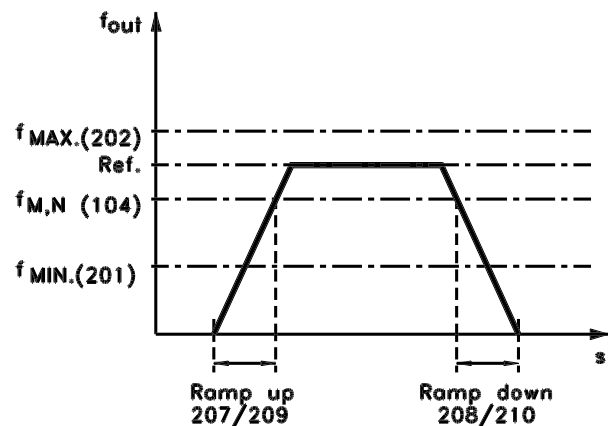

1752A047.12

Fig. 11

■ **5. Motor Start**

Press the START button to start the motor. Set motor speed in *Parameter 003*. Check if the direction of rotations is as shown in the display. It can be changed by swapping two phases of the motor cable.

Press the STOP button to stop the motor.

Select total or reduced Automatic Motor Adaption (AMA) in *Parameter 107*. For further description of AMA, see section *Automatic Motor Adaption, AMA*.

Press the START button to start the Automatic Motor Adaption (AMA).

Press the DISPLAY/STATUS button to leave the Quick Menu.

■ Available literature

Below is a list of the literature available for VLT 5000. It must be noted that there may be deviations from one country to another.

Supplied with the unit:

Operating instructions	MG.51.AX.YY
High Power Installation Guide	MI.90.JX.YY

Communication with VLT 5000:

VLT 5000 Profibus manual	MG.10.EX.YY
VLT 5000 DeviceNet manual	MG.50.HX.YY
VLT 5000 LonWorks manual	MG.50.MX.YY
VLT 5000 Modbus manual	MG.10.MX.YY
VLT 5000 Interbus manual	MG.10.OX.YY

Application options for VLT 5000:

VLT 5000 SyncPos option manual	MG.10.EX.YY
VLT 5000 Positioning controller manual	MG.50.PX.YY
VLT 5000 Synchronising controller manual	MG.10.NX.YY
Ring spinning option	MI.50.ZX.02
Wobble function option	MI.50.JX.02
Winder and Tension control option	MG.50.KX.02

Instructions for VLT 5000:

Loadsharing	MI.50.NX.02
VLT 5000 Brake resistors	MI.90.FX.YY
Brake resistors for horizontal applications (VLT 5001 - 5011) (Only in English and German)	MI.50.SX.YY
LC filter modules	MI.56.DX.YY
Converter for encoder inputs (5V TTL to 24 V DC) (Only in combined English/German)	MI.50.IX.51
Back Plate to VLT 5000 Series	MN.50.XX.02

Various literature for VLT 5000:

Design Guide	MG.51.BX.YY
Incorporating a VLT 5000 Profibus in a Simatic S5 SYSTEM	MC.50.CX.02
Incorporating a VLT 5000 Profibus in a Simatic S7 SYSTEM	MC.50.AX.02
Hoist and the VLT 5000 series	MN.50.RX.02

Miscellaneous (only in English):

Protection against electrical hazards	MN.90.GX.02
Choice of prefuses	MN.50.OX.02
VLT on IT mains	MN.90.CX.02
Filtering of harmonic currents	MN.90.FX.02
Handling aggressive environments	MN.90.IX.02
CI-TI™ contactors - VLT® frequency converters	MN.90.KX.02
VLT® frequency converters and UniOP operator panels	MN.90.HX.02

X = version number
YY = language version

■ General technical data
Mains supply (L1, L2, L3):

Supply voltage 200-240 V units	3 x 200/208/220/230/240 V ±10%
Supply voltage 380-500 V units	3 x 380/400/415/440/460/500 V ±10%
Supply voltage 525-600 V units	3 x 525/550/575/600 V ±10%
Supply voltage 525-690 V units	3 x 525/550/575/600/690 V ±10%
Supply frequency	48-62 Hz +/- 1 %

See the section on special conditions in the Design Guide

Max imbalance of supply voltage:

VLT 5001-5011, 380-500 V and 525-600 V and VLT 5001-5006, 200-240 V	±2.0% of rated supply voltage
VLT 5016-5062, 380-500 V and 525-600 V and VLT 5008-5027, 200-240 V	±1.5% of rated supply voltage
VLT 5072-5552, 380-500 V and VLT 5032-5052, 200-240 V	±3.0% of rated supply voltage
VLT 5042-5602, 525-690 V	±3.0% of rated supply voltage
True Power factor (λ)	0.90 nominal at rated load
Displacement Power Factor ($\cos \varphi$)	near unity (>0.98)
No. of switchings on supply input L1, L2, L3	approx. 1 time/min.

See the section on special conditions in the Design Guide

VLT output data (U, V, W):

Output voltage	0-100% of supply voltage
Output frequency VLT 5001-5027, 200-240 V	0-132 Hz, 0-1000 Hz
Output frequency VLT 5032-5052, 200-240 V	0-132 Hz, 0-450 Hz
Output frequency VLT 5001-5052, 380-500 V	0-132 Hz, 0-1000 Hz
Output frequency VLT 5062-5302, 380-500 V	0-132 Hz, 0-450 Hz
Output frequency VLT 5352-5552, 380-500 V	0-132 Hz, 0-300 Hz
Output frequency VLT 5001-5011, 525-600 V	0-132 Hz, 0-700 Hz
Output frequency VLT 5016-5052, 525-600 V	0-132 Hz, 0-1000 Hz
Output frequency VLT 5062, 525-600 V	0-132 Hz, 0-450 Hz
Output frequency VLT 5042-5302, 525-690 V	0-132 Hz, 0-200 Hz
Output frequency VLT 5352-5602, 525-690 V	0-132 Hz, 0-150 Hz
Rated motor voltage, 200-240 V units	200/208/220/230/240 V
Rated motor voltage, 380-500 V units	380/400/415/440/460/480/500 V
Rated motor voltage, 525-600 V units	525/550/575 V
Rated motor voltage, 525-690 V units	525/550/575/690 V
Rated motor frequency	50/60 Hz
Switching on output	Unlimited
Ramp times	0.05-3600 sec.

Torque characteristics:

Starting torque, VLT 5001-5027, 200-240 V and VLT 5001-5552, 380-500 V	160% for 1 min.
Starting torque, VLT 5032-5052, 200-240 V	150% for 1 min.
Starting torque, VLT 5001-5062, 525-600 V	160% for 1 min.
Starting torque, VLT 5042-5602, 525-690 V	160% for 1 min.
Starting torque	180% for 0.5 sec.
Acceleration torque	100%
Overload torque, VLT 5001-5027, 200-240 V and VLT 5001-5552, 380-500 V, VLT 5001-5062, 525-600 V, and VLT 5042-5602, 525-690 V	160%
Overload torque, VLT 5032-5052, 200-240 V	150%
Arresting torque at 0 rpm (closed loop)	100%

The torque characteristics given are for the frequency converter at the high overload torque level (160%). At the normal overload torque (110%), the values are lower.

Braking at high overload torque level

	Cycle time (s)	Braking duty cycle at 100% torque	Braking duty cycle at over torque (150/160%)
200-240 V			
5001-5027	120	Continuous	40%
5032-5052	300	10%	10%
380-500 V			
5001-5102	120	Continuous	40%
5122-5252	600	Continuous	10%
5302	600	40%	10%
5352-5552	600	40% ¹⁾	10% ²⁾
525-600 V			
5001-5062	120	Continuous	40%
525-690 V			
5042-5352	600	40%	10%
5402-5602	600	40% ³⁾	10% ⁴⁾

1) VLT 5502 at 90% torque. At 100% torque the braking duty cycle is 13%. At mains rating 441-500 V 100% torque the braking duty cycle is 17%.

VLT 5552 at 80% torque. At 100% torque the braking duty cycle is 8%.

2) Based on 300 second cycle:

For VLT 5502 the torque is 145%.

For VLT 5552 the torque is 130%.

3) VLT 5502 at 80% torque.

VLT 5602 at 71% torque.

4) Based on 300 second cycle.

For VLT 5502 the torque is 128%.

For VLT 5602 the torque is 114%.

Control card, digital inputs:

Number of programmable digital inputs	8
Terminal nos.	16, 17, 18, 19, 27, 29, 32, 33
Voltage level	0-24 V DC (PNP positive logics)
Voltage level, logical '0'	< 5 V DC
Voltage level, logical '1'	>10 V DC
Maximum voltage on input	28 V DC
Input resistance, R _i	2 kΩ
Scanning time per input	3 msec.

Reliable galvanic isolation: All digital inputs are galvanically isolated from the supply voltage (PELV). In addition, the digital inputs can be isolated from the other terminals on the control card by connecting an external 24 V DC supply and opening switch 4. VLT 5001-5062, 525-600 V do not meet PELV.

Control card, analogue inputs:

No. of programmable analogue voltage inputs/thermistor inputs	2
Terminal nos.	53, 54
Voltage level	0 - ±10 V DC (scalable)
Input resistance, R _i	10 kΩ
No. of programmable analogue current inputs	1
Terminal no.	60
Current range	0/4 - ±20 mA (scalable)
Input resistance, R _i	200 Ω
Resolution	10 bit + sign
Accuracy on input	Max. error 1% of full scale
Scanning time per input	3 msec.
Terminal no. ground	55

Reliable galvanic isolation: All analogue inputs are galvanically isolated from the supply voltage (PELV) as well as other inputs and outputs.*

* VLT 5001-5062, 525-600 V do not meet PELV.

Control card, pulse/encoder input:

No. of programmable pulse/encoder inputs	4
Terminal nos.	17, 29, 32, 33
Max. frequency on terminal 17	5 kHz
Max. frequency on terminals 29, 32, 33	20 kHz (PNP open collector)
Max. frequency on terminals 29, 32, 33	65 kHz (Push-pull)
Voltage level	0-24 V DC (PNP positive logics)
Voltage level, logical '0'	< 5 V DC
Voltage level, logical '1'	>10 V DC
Maximum voltage on input	28 V DC
Input resistance, R _i	2 kΩ
Scanning time per input	3 msec.
Resolution	10 bit + sign
Accuracy (100-1 kHz), terminals 17, 29, 33	Max. error: 0.5% of full scale
Accuracy (1-5 kHz), terminal 17	Max. error: 0.1% of full scale
Accuracy (1-65 kHz), terminals 29, 33	Max. error: 0.1% of full scale

Reliable galvanic isolation: All pulse/encoder inputs are galvanically isolated from the supply voltage (PELV). In addition, pulse and encoder inputs can be isolated from the other terminals on the control card by connecting an external 24 V DC supply and opening switch 4.*

** VLT 5001-5062, 525-600 V do not meet PELV.*

Control card, digital/pulse and analogue outputs:

No. of programmable digital and analogue outputs	2
Terminal nos.	42, 45
Voltage level at digital/pulse output	0 - 24 V DC
Minimum load to ground (terminal 39) at digital/pulse output	600 Ω
Frequency ranges (digital output used as pulse output)	0-32 kHz
Current range at analogue output	0/4 - 20 mA
Maximum load to ground (terminal 39) at analogue output	500 Ω
Accuracy of analogue output	Max. error: 1.5% of full scale
Resolution on analogue output.	8 bit

Reliable galvanic isolation: All digital and analogue outputs are galvanically isolated from the supply voltage (PELV), as well as other inputs and outputs.*

** VLT 5001-5062, 525-600 V do not meet PELV.*

Control card, 24 V DC supply:

Terminal nos.	12, 13
Max. load (short-circuit protection)	200 mA
Terminal nos. ground	20, 39

Reliable galvanic isolation: The 24 V DC supply is galvanically isolated from the supply voltage (PELV), but has the same potential as the analogue outputs.*

** VLT 5001-5062, 525-600 V do not meet PELV.*

Control card, RS 485 serial communication:

Terminal nos.	68 (TX+, RX+), 69 (TX-, RX-)
---------------	------------------------------

Reliable galvanic isolation: Full galvanic isolation.

Relay outputs: ¹⁾

No. of programmable relay outputs	2
Terminal nos., control card (resistive load only)	4-5 (make)

VLT® 5000 Series

Max. terminal load (AC1) on 4-5, control card	50 V AC, 1 A, 50 VA
Max. terminal load (DC1 (IEC 947)) on 4-5, control card	25 V DC, 2 A / 50 V DC, 1 A, 50 W
Max. terminal load (DC1) on 4-5, control card for UL/cUL applications	30 V AC, 1 A / 42.5 V DC, 1A
Terminal nos., power card (resistive and inductive load)	1-3 (break), 1-2 (make)
Max. terminal load (AC1) on 1-3, 1-2, power card	250 V AC, 2 A, 500 VA
Max. terminal load (DC1 (IEC 947)) on 1-3, 1-2, power card	25 V DC, 2 A / 50 V DC, 1A, 50 W
Min. terminal load (AC/DC) on 1-3, 1-2, power card	24 V DC, 10 mA / 24 V AC, 100 mA

1) Rated values for up to 300,000 operations.

At inductive loads the number of operations are reduced by 50%, alternatively the current can be reduced by 50%, thus the 300,000 operations are maintained.

Brake resistor terminals (only SB, EB, DE and PB units):

Terminal nos.	81, 82
---------------	--------

External 24 Volt DC supply:

Terminal nos.	35, 36
Voltage range	24 V DC \pm 15% (max. 37 V DC for 10 sec.)
Max. voltage ripple	2 V DC
Power consumption	15 W - 50 W (50 W for start-up, 20 msec.)
Min. pre-fuse	6 Amp

Reliable galvanic isolation: Full galvanic isolation if the external 24 V DC supply is also of the PELV type.

Cable lengths, cross-sections and connectors:

Max. motor cable length, screened cable	150 m
Max. motor cable length, unscreened cable	300 m
Max. motor cable length, screened cable VLT 5011 380-500 V	100 m
Max. motor cable length, screened cable VLT 5011 525-600 V and VLT 5008, normal overload mode, 525-600 V	50 m
Max. brake cable length, screened cable	20 m
Max. loadsharing cable length, screened cable	25 m from frequency converter to DC bar.

Max. cable cross-section for motor, brake and loadsharing, see Electrical data

Max. cable cross-section for 24 V external DC supply

- VLT 5001-5027 200-240 V; VLT 5001-5102 380-500 V; VLT 5001-5062 525-600 V	4 mm ² /10 AWG
- VLT 5032-5052 200-240 V; VLT 5122-5552 380-500 V; VLT 5042-5602 525-690 V	2.5 mm ² /12 AWG
Max. cross-section for control cables	1.5 mm ² /16 AWG
Max. cross-section for serial communication	1.5 mm ² /16 AWG

If UL/cUL is to be complied with, copper cable with temperature class 60/75°C must be used (VLT 5001 - 5062 380 - 500 V, 525 - 600 V and VLT 5001 - 5027 200 - 240 V).

If UL/cUL is to be complied with, copper cable with temperature class 75°C must be used (VLT 5072 - 5552 380 - 500 V, VLT 5032 - 5052 200 - 240 V, VLT 5042 - 5602 525 - 690 V).

Connectors are for use of both copper and aluminium cables, unless other is specified.

Accuracy of display readout (parameters 009-012):

Motor current [6] 0-140% load	Max. error: \pm 2.0% of rated output current
Torque % [7], -100 - 140% load	Max. error: \pm 5% of rated motor size
Output [8], power HP [9], 0-90% load	Max. error: \pm 5% of rated output

Control characteristics:

Frequency range	0 - 1000 Hz
Resolution on output frequency	\pm 0.003 Hz

VLT® 5000 Series

System response time	3 msec.
Speed, control range (open loop)	1:100 of synchro. speed
Speed, control range (closed loop)	1:1000 of synchro. speed
Speed, accuracy (open loop)	< 1500 rpm: max. error \pm 7.5 rpm
Speed, accuracy (closed loop)	< 1500 rpm: max. error \pm 1.5 rpm
Torque control accuracy (open loop)	0- 150 rpm: max. error \pm 20% of rated torque
Torque control accuracy (speed feedback)	Max. error \pm 5% of rated torque

All control characteristics are based on a 4-pole asynchronous motor

Externals:

Enclosure (dependent on power size)	IP 00, IP 20, IP 21, Nema 1, IP 54
Vibration test	0.7 g RMS 18-1000 Hz random. 3 directions for 2 hours (IEC 68-2-34/35/36)
Max. relative humidity	93 % (IEC 68-2-3) for storage/transport
Max. relative humidity	95 % non condensing (IEC 721-3-3; class 3K3) for operation
Aggressive environment (IEC 721 - 3 - 3)	Uncoated class 3C2
Aggressive environment (IEC 721 - 3 - 3)	Coated class 3C3
Ambient temperature IP 20/Nema 1 (high overload torque 160%)	Max. 45°C (24-hour average max. 40°C)
Ambient temperature IP 20/Nema 1 (normal overload torque 110%)	Max. 40°C (24-hour average max. 35°C)
Ambient temperature IP 54 (high overload torque 160%)	Max. 40°C (24-hour average max. 35°C)
Ambient temperature IP 54 (normal overload torque 110%)	Max. 40°C (24-hour average max. 35°C)
Ambient temperature IP 20/54 VLT 5011 500 V	Max. 40°C (24-hour average max. 35°C)
Ambient temperature IP 54 VLT 5042-5602, 525-690 V; and 5122-5552, 380-500 V (high overload torque 160%)	Max. 45°C (24-hour average max. 40°C)

Derating for high ambient temperature, see the Design Guide

Min. ambient temperature in full operation	0°C
Min. ambient temperature at reduced performance	-10°C
Temperature during storage/transport	-25 - +65/70°C
Max. altitude above sea level	1000 m

Derating for altitude over 1000 m above sealevel, see the Design Guide

EMC standards applied, Emission	EN 61000-6-3, EN 61000-6-4, EN 61800-3, EN 55011 EN 61000-6-2, EN 61000-4-2, EN 61000-4-3, EN 61000-4-4
EMC standards applied, Immunity	EN 61000-4-5, EN 61000-4-6, VDE 0160/1990.12

See section on special conditions in the Design Guide

VLT 5001-5062, 525 - 600 V do not comply with EMC or Low Voltage Directives.

IP54 units are not intended for direct outdoor installation. The IP54 rating does not relate to other exposures as sun, icing, wind blown driving rain. Under such circumstances Danfoss recommends to install the units in an enclosure designed for these environmental conditions. Alternatively, an installation at minimum 0.5 m above surface and covered by a shed is recommended

VLT 5000 Series protection:

Electronic motor thermal protection against overload.

Temperature monitoring of heat-sink ensures that the frequency converter cuts out if the temperature reaches 90°C for IP 00, IP 20 and Nema 1. For IP 54, the cut-out temperature is 80°C. An overtemperature can only be reset when the temperature of the heat-sink has fallen below 60°C.

For the units mentioned below, the limits are as follows:

- VLT 5122, 380-500 V, cuts out at 75°C and can be reset if the temperature has fallen below 60°C.
- VLT 5152, 380-500 V, cuts out at 80°C and can be reset if the temperature has fallen below 60°C.
- VLT 5202, 380-500 V, cuts out at 95°C and can be reset if the temperature has fallen below 65°C.
- VLT 5252, 380-500 V, cuts out at 95°C and can be reset if the temperature has fallen below 65°C.
- VLT 5302, 380-500 V, cuts out at 105°C and can be reset if the temperature has fallen below 75°C.
- VLT 5352-5552, 380-500 V, cut out at 85°C and can be reset if the temperature has fallen below 60°C.
- VLT 5042-5122, 525-690 V, cut out at 75°C and can be reset if the temperature has fallen below 60°C.
- VLT 5152, 525-690 V, cuts out at 80°C and can be reset if the temperature has fallen below 60°C.
- VLT 5202-5352, 525-690 V, cut out at 100°C and can be reset if the temperature has fallen below 70°C.
- VLT 5402-5602, 525-690 V, cut out at 75°C and can be reset if the temperature has fallen below 60°C.

The frequency converter is protected against short-circuiting on motor terminals U, V, W.

The frequency converter is protected against earth fault on motor terminals U, V, W.

Monitoring of the intermediate circuit voltage ensures that the frequency converter cuts out if the intermediate circuit voltage becomes too high or too low.

If a motor phase is missing, the frequency converter cuts out, see parameter 234 *Motor phase monitor*.

If there is a mains fault, the frequency converter is able to carry out a controlled deceleration.

If a mains phase is missing, the frequency converter will cut out when a load is placed on the motor.

■ Electrical data

■ Bookstyle and Compact, Mains supply 3 x 200 - 240 V

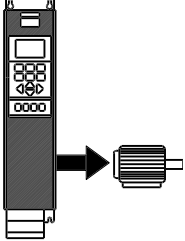
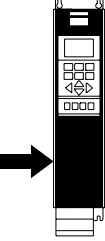
According to international requirements		VLT type	5001	5002	5003	5004	5005	5006
	Output current	$I_{VLT,N}$ [A]	3.7	5.4	7.8	10.6	12.5	15.2
		$I_{VLT,MAX}$ (60 s) [A]	5.9	8.6	12.5	17	20	24.3
	Output (240 V)	$S_{VLT,N}$ [kVA]	1.5	2.2	3.2	4.4	5.2	6.3
	Typical shaft output	$P_{VLT,N}$ [kW]	0.75	1.1	1.5	2.2	3.0	3.7
	Typical shaft output	$P_{VLT,N}$ [HP]	1	1.5	2	3	4	5
		Max. cable cross-section to motor, brake and loadsharing [mm ²]/[AWG] ²	4/10	4/10	4/10	4/10	4/10	4/10
		Rated input current (200 V) $I_{L,N}$ [A]	3.4	4.8	7.1	9.5	11.5	14.5
		Max. cable cross-section power [mm ²]/[AWG] ²	4/10	4/10	4/10	4/10	4/10	4/10
		Max. pre-fuses [-]/UL ¹ [A]	16/10	16/10	16/15	25/20	25/25	35/30
		Efficiency ³	0.95	0.95	0.95	0.95	0.95	0.95
		Weight IP 20 EB Bookstyle [kg]	7	7	7	9	9	9.5
		Weight IP 20 EB Compact [kg]	8	8	8	10	10	10
		Weight IP 54 Compact [kg]	11.5	11.5	11.5	13.5	13.5	13.5
		Power loss at max. load. [W]	58	76	95	126	172	194
		Enclosure	IP 20/ IP54	IP 20/ IP54	IP 20/ IP54	IP 20/ IP54	IP 20/ IP54	IP 20/ IP54

1. For type of fuse see section *Fuses*.

2. American Wire Gauge.

3. Measured using 30 m screened motor cables at rated load and rated frequency.

■ Compact, Mains supply 3 x 200 - 240 V

According to international requirements	VLT type	5008	5011	5016	5022	5027
Normal overload torque (110 %):						
Output current	$I_{VLT,N}$ [A]	32	46	61.2	73	88
	$I_{VLT, MAX}$ (60 s) [A]	35.2	50.6	67.3	80.3	96.8
Output (240 V)	$S_{VLT,N}$ [kVA]	13.3	19.1	25.4	30.3	36.6
Typical shaft output	$P_{VLT,N}$ [kW]	7.5	11	15	18.5	22
Typical shaft output	$P_{VLT,N}$ [HP]	10	15	20	25	30
High overload torque (160 %):						
Output current	$I_{VLT,N}$ [A]	25	32	46	61.2	73
	$I_{VLT, MAX}$ (60 s) [A]	40	51.2	73.6	97.9	116.8
Output (240 V)	$S_{VLT,N}$ [kVA]	10	13	19	25	30
Typical shaft output	$P_{VLT,N}$ [kW]	5.5	7.5	11	15	18.5
Typical shaft output	$P_{VLT,N}$ [HP]	7.5	10	15	20	25
Max. cable cross-section to motor, brake and loadsharing [mm ² /AWG] ^{2) 5)}	IP 54	16/6	16/6	35/2	35/2	50/0
	IP 20	16/6	35/2	35/2	35/2	50/0
Min. cable cross-section to motor, brake and loadsharing ⁴⁾ [mm ² /AWG] ²⁾		10/8	10/8	10/8	10/8	16/6
<hr/>						
Rated input current	(200 V) $I_{L,N}$ [A]	32	46	61	73	88
Max. cable cross-section, power [mm ²]/[AWG] ^{2) 5)}	IP 54	16/6	16/6	35/2	35/2	50/0
	IP 20	16/6	35/2	35/2	35/2	50/0
Max. pre-fuses	[-]/UL ¹⁾ [A]	50	60	80	125	125
Efficiency ³⁾		0.95	0.95	0.95	0.95	0.95
Weight IP 20 EB	[kg]	21	25	27	34	36
Weight IP 54	[kg]	38	40	53	55	56
Power loss at max. load.						
- high overload torque (160 %)	[W]	340	426	626	833	994
- normal overload torque (110 %)	[W]	426	545	783	1042	1243
Enclosure		IP 20/ IP 54	IP 20/ IP 54	IP 20/ IP 54	IP 20/ IP 54	IP 20/ IP 54

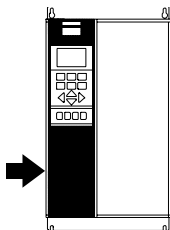
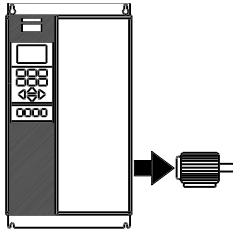

1. For type of fuse see section *Fuses*

2. American Wire Gauge.

3. Measured using 30 m screened motor cables at rated load and rated frequency.

4. Min. cable cross-section is the smallest cable cross-section allowed to be fitted on the terminals to comply with IP 20. Always comply with national and local regulations on min. cable cross-section.

5. Aluminium cables with cross-section above 35 mm² must be connected by use of a Al-Cu connector.

■ Compact, Mains supply 3 x 200 - 240 V

According to international requirements		VLT type		
		5032	5042	5052
Normal overload torque (110 %):				
Output current	$I_{VLT,N}$ [A] (200-230 V)	115	143	170
	$I_{VLT,MAX}$ (60 s) [A] (200-230 V)	127	158	187
	$I_{VLT,N}$ [A] (231-240 V)	104	130	154
	$I_{VLT,MAX}$ (60 s) [A] (231-240 V)	115	143	170
Output	$S_{VLT,N}$ [kVA] (208 V)	41	52	61
	$S_{VLT,N}$ [kVA] (230 V)	46	57	68
	$S_{VLT,N}$ [kVA] (240 V)	43	54	64
Typical shaft output	[HP] (208 V)	40	50	60
Typical shaft output	[kW] (230 V)	30	37	45
High overload torque (160 %):				
Output current	$I_{VLT,N}$ [A] (200-230 V)	88	115	143
	$I_{VLT,MAX}$ [A] (200-230 V)	132	173	215
	$I_{VLT,N}$ [A] (231-240 V)	80	104	130
	$I_{VLT,MAX}$ [A] (231-240 V)	120	285	195
Output	$S_{VLT,N}$ [kVA] (208 V)	32	41	52
	$S_{VLT,N}$ [kVA] (230 V)	35	46	57
	$S_{VLT,N}$ [kVA] (240 V)	33	43	54
Typical shaft output	[HP] (208 V)	30	40	50
	[kW] (230 V)	22	30	37
Max. cable cross-section to motor and loadsharing	[mm ²] ^{4,6}		120	
	[AWG] ^{2,4,6}		300 mcm	
Max. cable cross-section to brake	[mm ²] ^{4,6}		25	
	[AWG] ^{2,4,6}		4	
Normal overload torque (110 %):				
Rated input current	$I_{L,N}$ [A] (230 V)	101.3	126.6	149.9
Normal overload torque (150 %):				
Rated input current	$I_{L,N}$ [A] (230 V)	77,9	101,3	126,6
Max. cable cross-section power supply	[mm ²] ^{4,6}		120	
	[AWG] ^{2,4,6}		300 mcm	
Min. cable cross-section to motor, power supply, brake and loadsharing	[mm ²] ^{4,6}		6	
	[AWG] ^{2,4,6}		8	
Max. pre-fuses (mains) [-]/UL	[A] ¹	150/150	200/200	250/250
Efficiency ³		0,96-0,97		
Power loss	Normal overload [W]	1089	1361	1612
	High overload [W]	838	1089	1361
Weight	IP 00 [kg]	101	101	101
Weight	IP 20 Nema1 [kg]	101	101	101
Weight	IP 54 Nema12 [kg]	104	104	104
Enclosure		IP 00 / Nema 1 (IP 20) / IP 54		

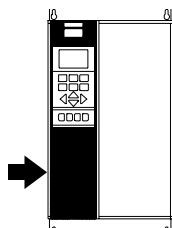
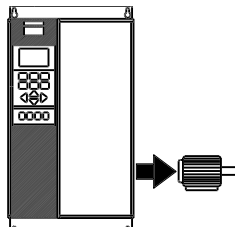

1. For type of fuse see section *Fuses*
2. American Wire Gauge.
3. Measured using 30 m screened motor cables at rated load and rated frequency.
4. Max. cable cross-section is the maximum possible cable cross-section allowed to be fitted on the terminals. Min. cable cross-section is the minimum allowed cross-section. Always comply with national and local regulations on min. cable cross-section.
5. Weight without shipping container.
6. Connection stud: M8 Brake: M6.

■ Bookstyle and Compact, Mains supply 3 x 380 - 500 V

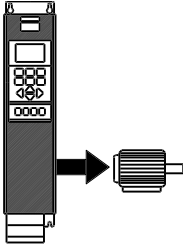
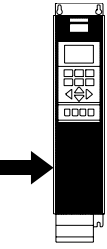
According to international requirements		VLT type	5001	5002	5003	5004	
	Output current	$I_{VLT,N}$ [A] (380-440 V)	2.2	2.8	4.1	5.6	
		$I_{VLT,MAX}$ (60 s) [A] (380-440 V)	3.5	4.5	6.5	9	
	Output	$I_{VLT,N}$ [A] (441-500 V)	1.9	2.6	3.4	4.8	
		$I_{VLT,MAX}$ (60 s) [A] (441-500 V)	3	4.2	5.5	7.7	
		$S_{VLT,N}$ [kVA] (380-440 V)	1.7	2.1	3.1	4.3	
		$S_{VLT,N}$ [kVA] (441-500 V)	1.6	2.3	2.9	4.2	
Typical shaft output	$P_{VLT,N}$ [kW]	0.75	1.1	1.5	2.2		
Typical shaft output	$P_{VLT,N}$ [HP]	1	1.5	2	3		
Max. cable cross-section to motor, brake and loadsharing [mm ²]/[AWG] ²)			4/10	4/10	4/10	4/10	
	Rated input current	$I_{L,N}$ [A] (380 V)	2.3	2.6	3.8	5.3	
		$I_{L,N}$ [A] (460 V)	1.9	2.5	3.4	4.8	
	Max. cable cross-section, power [mm ²]/[AWG] ²)			4/10	4/10	4/10	4/10
	Max. pre-fuses [-]/UL ¹) [A]			16/6	16/6	16/10	16/10
	Efficiency ³)			0.96	0.96	0.96	0.96
	Weight IP 20 EB Bookstyle [kg]			7	7	7	7.5
	Weight IP 20 EB Compact [kg]			8	8	8	8.5
	Weight IP 54 Compact [kg]			11.5	11.5	11.5	12
	Power loss at max. load		[W]	55	67	92	110
	Enclosure			IP 20/ IP 54	IP 20/ IP 54	IP 20/ IP 54	IP 20/ IP 54

1. For type of fuse see section *Fuses*.

2. American Wire Gauge.

3. Measured using 30 m screened motor cables at rated load and rated frequency.

Bookstyle and Compact, Mains supply 3 x 380 - 500

V

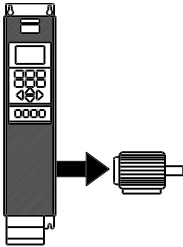
According to international requirements		VLT type	5005	5006	5008	5011
	Output current	$I_{VLT,N}$ [A] (380-440 V)	7.2	10	13	16
		$I_{VLT,MAX}$ (60 s) [A] (380-440 V)	11.5	16	20.8	25.6
	Output	$I_{VLT,N}$ [A] (441-500 V)	6.3	8.2	11	14.5
		$I_{VLT,MAX}$ (60 s) [A] (441-500 V)	10.1	13.1	17.6	23.2
	$S_{VLT,N}$ [kVA] (380-440 V)	5.5	7.6	9.9	12.2	
	$S_{VLT,N}$ [kVA] (441-500 V)	5.5	7.1	9.5	12.6	
	Typical shaft output	$P_{VLT,N}$ [kW]	3.0	4.0	5.5	7.5
	Typical shaft output	$P_{VLT,N}$ [HP]	4	5	7.5	10
	Max. cable cross-section to motor, brake and loadsharing [mm ²] / [AWG] ²)		4/10	4/10	4/10	4/10

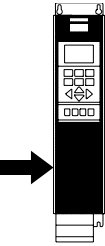
	Rated input current	$I_{L,N}$ [A] (380 V)	7	9.1	12.2	15.0
		$I_{L,N}$ [A] (460 V)	6	8.3	10.6	14.0
	Max. cable cross-section power [mm ²] / [AWG] ²)		4/10	4/10	4/10	4/10
	Max. pre-fuses [-] / UL ¹) [A]		16/15	25/20	25/25	35/30
	Efficiency ³)		0.96	0.96	0.96	0.96
	Weight IP 20 EB Bookstyle [kg]		7.5	9.5	9.5	9.5
	Weight IP 20 EB Compact [kg]		8.5	10.5	10.5	10.5
	Weight IP 54 EB Compact [kg]		12	14	14	14
	Power loss at max. load.	[W]	139	198	250	295
	Enclosure		IP 20/ IP 54	IP 20/ IP 54	IP 20/ IP 54	IP 20/ IP 54

1. For type of fuse see section *Fuses*.

2. American Wire Gauge.

3. Measured using 30 m screened motor cables at rated load and rated frequency.

■ Compact, Mains supply 3 x 380 - 500 V

According to international requirements		VLT type	5016	5022	5027
Normal overload torque (110 %):					
Output current	$I_{VLT,N}$ [A] (380-440 V)		32	37.5	44
	$I_{VLT,MAX}$ (60 s) [A] (380-440 V)		35.2	41.3	48.4
Output	$I_{VLT,N}$ [A] (441-500 V)		27.9	34	41.4
	$I_{VLT,MAX}$ (60 s) [A] (441-500 V)		30.7	37.4	45.5
Output	$S_{VLT,N}$ [kVA] (380-440 V)		24.4	28.6	33.5
	$S_{VLT,N}$ [kVA] (441-500 V)		24.2	29.4	35.8
Typical shaft output	$P_{VLT,N}$ [kW]		15	18.5	22
Typical shaft output	$P_{VLT,N}$ [HP]		20	25	30
High overload torque (160 %):					
Output current	$I_{VLT,N}$ [A] (380-440 V)		24	32	37.5
	$I_{VLT,MAX}$ (60 s) [A] (380-440 V)		38.4	51.2	60
Output	$I_{VLT,N}$ [A] (441-500 V)		21.7	27.9	34
	$I_{VLT,MAX}$ (60 s) [A] (441-500 V)		34.7	44.6	54.4
Output	$S_{VLT,N}$ [kVA] (380-440 V)		18.3	24.4	28.6
	$S_{VLT,N}$ [kVA] (441-500 V)		18.8	24.2	29.4
Typical shaft output	$P_{VLT,N}$ [kW]		11	15	18.5
Typical shaft output	$P_{VLT,N}$ [HP]		15	20	25
Max. cable cross-section to motor, brake and loadsharing [mm ²]/[AWG] ²⁾		IP 54	16/6	16/6	16/6
		IP 20	16/6	16/6	35/2
Min. cable cross-section to motor, brake and loadsharing [mm ²]/[AWG] ^{2) 4)}			10/8	10/8	10/8
Rated input current	$I_{L,N}$ [A] (380 V)		32	37.5	44
	$I_{L,N}$ [A] (460 V)		27.6	34	41
Max. cable cross-section, power [mm ²]/[AWG]		IP 54	16/6	16/6	16/6
		IP 20	16/6	16/6	35/2
Max. pre-fuses	[–]/UL ¹⁾ [A]		63/40	63/50	63/60
Efficiency ³⁾			0.96	0.96	0.96
Weight IP 20 EB	[kg]		21	22	27
Weight IP 54	[kg]		41	41	42
Power loss at max. load.					
- high overload torque (160 %)	[W]		419	559	655
- normal overload torque (110 %)	[W]		559	655	768
Enclosure			IP 20/	IP 20/	IP 20/
			IP 54	IP 54	IP 54

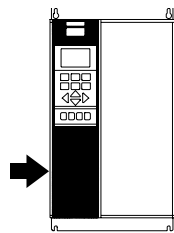
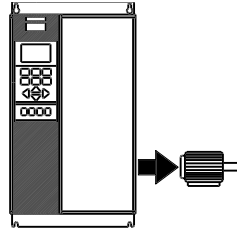

1. For type of fuse see section *Fuses*.

2. American Wire Gauge.

3. Measured using 30 m screened motor cables at rated load and rated frequency.

4. Min. cable cross-section is the smallest cable cross-section allowed to be fitted on the terminals to comply with IP 20. Always comply with national and local regulations on min. cable cross-section.

VLT® 5000 Series

Compact, Mains supply 3 x 380 - 500 V

According to international requirements		VLT type	5032	5042	5052
Normal overload torque (110 %):					
Output current	$I_{VLT,N}$ [A] (380-440 V)		61	73	90
	$I_{VLT,MAX}$ (60 s) [A] (380-440 V)		67.1	80.3	99
Output	$I_{VLT,N}$ [A] (441-500 V)		54	65	78
	$I_{VLT,MAX}$ (60 s) [A] (441-500 V)		59.4	71.5	85.8
Output	$S_{VLT,N}$ [kVA] (380-440 V)		46.5	55.6	68.6
	$S_{VLT,N}$ [kVA] (441-500 V)		46.8	56.3	67.5
Typical shaft output	$P_{VLT,N}$ [kW]		30	37	45
Typical shaft output	$P_{VLT,N}$ [HP]		40	50	60
High overload torque (160 %):					
Output current	$I_{VLT,N}$ [A] (380-440 V)		44	61	73
	$I_{VLT,MAX}$ (60 s) [A] (380-440 V)		70.4	97.6	116.8
Output	$I_{VLT,N}$ [A] (441-500 V)		41.4	54	65
	$I_{VLT,MAX}$ (60 s) [A] (441-500 V)		66.2	86	104
Output	$S_{VLT,N}$ [kVA] (380-440 V)		33.5	46.5	55.6
	$S_{VLT,N}$ [kVA] (441-500 V)		35.9	46.8	56.3
Typical shaft output	$P_{VLT,N}$ [kW]		22	30	37
Typical shaft output	$P_{VLT,N}$ [HP]		30	40	50
Max. cable cross-section to motor, brake and loadsharing [mm ²]/[AWG] ^{2) 5)}	IP 54		35/2	35/2	50/0
Min. cable cross-section to motor, brake and loadsharing [mm ²]/[AWG] ^{2) 4)}	IP 20		35/2	35/2	50/0
Rated input current	$I_{L,N}$ [A] (380 V)		60	72	89
	$I_{L,N}$ [A] (460 V)		53	64	77
Max. cable cross-section power [mm ²]/[AWG] ^{2) 5)}	IP 54		35/2	35/2	50/0
Max. pre-fuses	[-]/UL ¹⁾ [A]		80/80	100/100	125/125
Efficiency ³⁾			0.96	0.96	0.96
Weight IP 20 EB	[kg]		28	41	42
Weight IP 54	[kg]		54	56	56
Power loss at max. load.					
- high overload torque (160 %)	[W]		768	1065	1275
- normal overload torque (110 %)	[W]		1065	1275	1571
Enclosure			IP 20/ IP 54	IP 20/ IP 54	IP 20/ IP 54

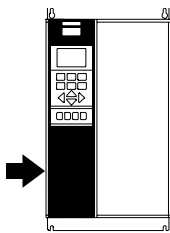
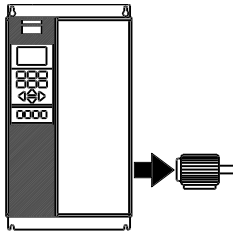

1. For type of fuse see section *Fuses*.

2. American Wire Gauge.

3. Measured using 30 m screened motor cables at rated load and rated frequency.

4. Min. cable cross-section is the smallest cable cross-section allowed to be fitted on the terminals to comply with IP 20. Always comply with national and local regulations on min. cable cross-section.

5. Aluminium cables with cross-section above 35 mm² must be connected by use of a Al-Cu connector.

Compact, Mains supply 3 x 380 - 500 V

According to international requirements

		VLT type	5062	5072	5102
Normal overload torque (110 %):					
Output current	$I_{VLT,N}$ [A] (380-440 V)		106	147	177
	$I_{VLT,MAX}$ (60 s) [A] (380-440 V)		117	162	195
	$I_{VLT,N}$ [A] (441-500 V)		106	130	160
	$I_{VLT,MAX}$ (60 s) [A] (441-500 V)		117	143	176
Output	$S_{VLT,N}$ [kVA] (380-440 V)		80.8	102	123
	$S_{VLT,N}$ [kVA] (441-500 V)		91.8	113	139
Typical shaft output	$P_{VLT,N}$ [kW] (400 V)		55	75	90
	$P_{VLT,N}$ [HP] (460 V)		75	100	125
	$P_{VLT,N}$ [kW] (500 V)		75	90	110
High overload torque (160 %):					
Output current	$I_{VLT,N}$ [A] (380-440 V)		90	106	147
	$I_{VLT,MAX}$ (60 s) [A] (380-440 V)		135	159	221
	$I_{VLT,N}$ [A] (441-500 V)		80	106	130
	$I_{VLT,MAX}$ (60 s) [A] (441-500 V)		120	159	195
Output	$S_{VLT,N}$ [kVA] (380-440 V)		68.6	73.0	102
	$S_{VLT,N}$ [kVA] (441-500 V)		69.3	92.0	113
Typical shaft output	$P_{VLT,N}$ [kW] (400 V)		45	55	75
	$P_{VLT,N}$ [HP] (460 V)		60	75	100
	$P_{VLT,N}$ [kW] (500 V)		55	75	90
Max. cable cross-section to motor,	IP 54	50/0 ⁵⁾	150/300 mcm ⁶⁾	150/300 mcm ⁶⁾	150/300 mcm ⁶⁾
brake and loadsharing [mm ²]/[AWG] ²⁾	IP 20	50/0 ⁵⁾	120/250 mcm ⁵⁾	120/250 mcm ⁵⁾	120/250 mcm ⁵⁾
Min. cable cross-section to motor, brake and loadsharing [mm ²]/[AWG] ⁴⁾			16/6	25/4	25/4
Rated input current	$I_{L,N}$ [A] (380 V)		104	145	174
	$I_{L,N}$ [A] (460 V)		104	128	158
Max. cable cross-section	IP 54	50/0 ⁵⁾	150/300 mcm	150/300 mcm	150/300 mcm
power[mm ²]/[AWG] ²⁾	IP 20	50/0 ⁵⁾	120/250 mcm ⁵⁾	120/250 mcm ⁵⁾	120/250 mcm ⁵⁾
Max. pre-fuses	[]/UL ¹⁾ [A]		160/150	225/225	250/250
Efficiency ³⁾			>0.97	>0.97	>0.97
Weight IP 20 EB	[kg]		43	54	54
Weight IP 54	[kg]		60	77	77
Power loss at max. load.					
- high overload torque (160 %)	[W]		1122	1058	1467
- normal overload torque (110 %)	[W]		1322	1467	1766
Enclosure			IP20/ IP 54	IP20/ IP 54	IP20/ IP 54

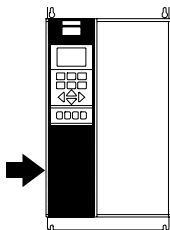
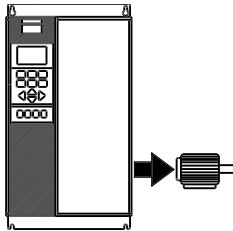
 1. For type of fuse see section *Fuses*.

2. American Wire Gauge.

3. Measured using 30 m screened motor cables at rated load and rated frequency.

4. Min. cable cross-section is the smallest cable cross-section allowed to be fitted on the terminals to comply with IP 20. Always comply with national and local regulations on min. cable cross-section.

 5. Aluminium cables with cross-section above 35 mm² must be connected by use of a Al-Cu connector. used.

 6. Brake and loadsharing: 95 mm² / AWG 3/0

■ Compact, Mains supply 3 x 380 - 500 V

According to international requirements		VLT type	5122	5152	5202	5252	5302
Normal overload current (110 %):							
Output current	$I_{VLT,N}$ [A] (380-440 V)		212	260	315	395	480
	$I_{VLT,MAX}$ (60 s) [A] (380-440 V)		233	286	347	434	528
	$I_{VLT,N}$ [A] (441-500 V)		190	240	302	361	443
	$I_{VLT,MAX}$ (60 s) [A] (441-500 V)		209	264	332	397	487
Output	$S_{VLT,N}$ [kVA] (400 V)		147	180	218	274	333
	$S_{VLT,N}$ [kVA] (460 V)		151	191	241	288	353
	$S_{VLT,N}$ [kVA] (500 V)		165	208	262	313	384
Typical shaft output	[kW] (400 V)		110	132	160	200	250
	[HP] (460 V)		150	200	250	300	350
	[kW] (500 V)		132	160	200	250	315
High overload torque (160 %):							
Output current	$I_{VLT,N}$ [A] (380-440 V)		177	212	260	315	395
	$I_{VLT,MAX}$ (60 s) [A] (380-440 V)		266	318	390	473	593
	$I_{VLT,N}$ [A] (441-500 V)		160	190	240	302	361
	$I_{VLT,MAX}$ (60 s) [A] (441-500 V)		240	285	360	453	542
Output	$S_{VLT,N}$ [kVA] (400 V)		123	147	180	218	274
	$S_{VLT,N}$ [kVA] (460 V)		127	151	191	241	288
	$S_{VLT,N}$ [kVA] (500 V)		139	165	208	262	313
Typical shaft output	[kW] (400 V)		90	110	132	160	200
	[HP] (460 V)		125	150	200	250	300
	[kW] (500 V)		110	132	160	200	250
Max. cable cross-section to motor	[mm ²] ^{4,6}		2 x 70		2 x 185		
	[AWG] ^{2,4,6}		2 x 2/0		2 x 350 mcm		
Max. cable cross-section to loadsharing and brake	[mm ²] ^{4,6}		2 x 70		2 x 185		
	[AWG] ^{2,4,6}		2 x 2/0		2 x 350 mcm		
Normal overload current (110 %):							
Rated input current	$I_{L,N}$ [A] (380-440 V)		208	256	317	385	467
	$I_{L,N}$ [A] (441-500 V)		185	236	304	356	431
High overload torque (160 %):							
Rated input current	$I_{L,N}$ [A] (380-440 V)		174	206	256	318	389
	$I_{L,N}$ [A] (441-500 V)		158	185	236	304	356
Max. cable cross-section power supply	[mm ²] ^{4,6}		2 x 70		2 x 185		
	[AWG] ^{2,4,6}		2 x 2/0		2 x 350 mcm		
Max. pre-fuses (mains) [-]/UL	[A] ¹		300/300	350/350	450/400	500/500	630/600
Efficiency ³			0,98				
Power loss	Normal overload [W]		2619	3309	4163	4977	6107
	High overload [W]		2206	2619	3309	4163	4977
Weight	IP 00 [kg]		82	91	112	123	138
Weight	IP 21/Nema1 [kg]		96	104	125	136	151
Weight	IP 54/Nema12 [kg]		96	104	125	136	151
Enclosure			IP 00, IP 21/Nema 1 and IP 54/Nema12				

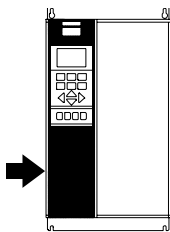
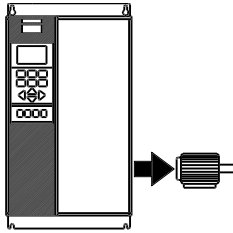

1. For type of fuse see section *Fuses*
2. American Wire Gauge.
3. Measured using 30 m screened motor cables at rated load and rated frequency.
4. Max. cable cross-section is the maximum possible cable cross-section allowed to be fitted on the terminals. Always comply with national and local regulations on min. cable cross-section.
5. Weight without shipping container.
6. Connection bolt power supply and motor: M10; Brake and loadsharing: M8

■ Compact, Mains supply 3 x 380 - 500 V

According to international requirements		VLT type	5352	5452	5502	5552
Normal overload current (110 %):						
Output current	$I_{VLT,N}$ [A] (380-440 V)	600	658	745	800	
	$I_{VLT,MAX}$ (60 s) [A] (380-440 V)	660	724	820	880	
Output	$I_{VLT,N}$ [A] (441-500 V)	540	590	678	730	
	$I_{VLT,MAX}$ (60 s) [A] (441-500 V)	594	649	746	803	
Typical shaft output	$S_{VLT,N}$ [kVA] (400 V)	416	456	516	554	
	$S_{VLT,N}$ [kVA] (460 V)	430	470	540	582	
	$S_{VLT,N}$ [kVA] (500 V)	468	511	587	632	
Typical shaft output	[kW] (400 V)	315	355	400	450	
	[HP] (460 V)	450	500	550/600	600	
	[kW] (500 V)	355	400	500	530	
High overload torque (160 %):						
Output current	$I_{VLT,N}$ [A] (380-440 V)	480	600	658	695	
	$I_{VLT,MAX}$ (60 s) [A] (380-440 V)	720	900	987	1042	
Output	$I_{VLT,N}$ [A] (441-500 V)	443	540	590	678	
	$I_{VLT,MAX}$ (60 s) [A] (441-500 V)	665	810	885	1017	
Typical shaft output	$S_{VLT,N}$ [kVA] (400 V)	333	416	456	482	
	$S_{VLT,N}$ [kVA] (460 V)	353	430	470	540	
	$S_{VLT,N}$ [kVA] (500 V)	384	468	511	587	
Typical shaft output	[kW] (400 V)	250	315	355	400	
	[HP] (460 V)	350	450	500	550	
	[kW] (500 V)	315	355	400	500	
Max. cable cross-section to motor and loadsharing	[mm ²] ^{4,6}			4x240		
Max. cable cross-section to brake	[AWG] ^{2,4,6}			4x500 mcm		
	[mm ²] ^{4,6}			2x185		
	[AWG] ^{2,4,6}			2x350 mcm		
Normal overload current (110 %):						
Rated input current	$I_{L,N}$ [A] (380-440 V)	590	647	733	787	
	$I_{L,N}$ [A] (441-500 V)	531	580	667	718	
High overload torque (160 %):						
Rated input current	$I_{L,N}$ [A] (380-440 V)	472	590	647	684	
	$I_{L,N}$ [A] (441-500 V)	436	531	580	667	
Max. cable cross-section power supply	[mm ²] ^{4,6}			4x240		
	[AWG] ^{2,4,6}			4x500 mcm		
Max. pre-fuses (mains) [-]/UL	[A] ¹	700/700	900/900	900/900	900/900	
Efficiency ³				0,98		
Power loss	Normal overload [W]	7630	7701	8879	9428	
	High overload [W]	6005	6960	7691	7964	
Weight	IP 00 [kg]	221	234	236	277	
Weight	IP 21/Nema1 [kg]	263	270	272	313	
Weight	IP 54/Nema12 [kg]	263	270	272	313	
Enclosure		IP 00, IP 21/Nema 1 and IP 54/Nema12				

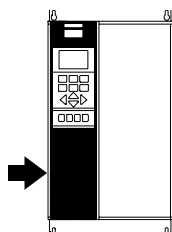
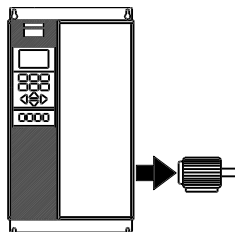

1. For type of fuse see section *Fuses*
2. American Wire Gauge.
3. Measured using 30 m screened motor cables at rated load and rated frequency.
4. Max. cable cross-section is the maximum possible cable cross-section allowed to be fitted on the terminals. Always comply with national and local regulations on min. cable cross-section.
5. Weight without shipping container.
6. Connection bolt power supply, motor and loadsharing: M10 (compression lug), 2xM8 (box lug), M8 (brake)

VLT® 5000 Series

■ Compact, Mains supply 3 x 525 - 600 V

According to international requirements	VLT type	5001	5002	5003	5004
Normal overload torque (110 %):					
Output current	$I_{VLT,N}$ [A] (550 V)	2.6	2.9	4.1	5.2
	$I_{VLT,MAX}$ (60 s) [A] (550 V)	2.9	3.2	4.5	5.7
	$I_{VLT,N}$ [A] (575 V)	2.4	2.7	3.9	4.9
	$I_{VLT,MAX}$ (60 s) [A] (575 V)	2.6	3.0	4.3	5.4
Output	$S_{VLT,N}$ [kVA] (550 V)	2.5	2.8	3.9	5.0
	$S_{VLT,N}$ [kVA] (575 V)	2.4	2.7	3.9	4.9
Typical shaft output	$P_{VLT,N}$ [kW]	1.1	1.5	2.2	3
Typical shaft output	$P_{VLT,N}$ [HP]	1.5	2	3	4
High overload torque (160%):					
Output current	$I_{VLT,N}$ [A] (550 V)	1.8	2.6	2.9	4.1
	$I_{VLT,MAX}$ (60 s) [A] (550 V)	2.9	4.2	4.6	6.6
	$I_{VLT,N}$ [A] (575 V)	1.7	2.4	2.7	3.9
	$I_{VLT,MAX}$ (60 s) [A] (575 V)	2.7	3.8	4.3	6.2
Output	$S_{VLT,N}$ [kVA] (550 V)	1.7	2.5	2.8	3.9
	$S_{VLT,N}$ [kVA] (575 V)	1.7	2.4	2.7	3.9
Typical shaft output	$P_{VLT,N}$ [kW]	0.75	1.1	1.5	2.2
Typical shaft output	$P_{VLT,N}$ [HP]	1	1.5	2	3
Max. cable cross-section to motor, brake and loadsharing [mm ²]/[AWG] ²⁾		4/10	4/10	4/10	4/10
Normal overload torque (110 %):					
Rated input current	$I_{L,N}$ [A] (550 V)	2.5	2.8	4.0	5.1
	$I_{L,N}$ [A] (600 V)	2.2	2.5	3.6	4.6
High overload torque (160 %):					
Rated input current	$I_{L,N}$ [A] (550 V)	1.8	2.5	2.8	4.0
	$I_{L,N}$ [A] (600 V)	1.6	2.2	2.5	3.6
Max. cable cross-section, power [mm ²]/[AWG] ²⁾		4/10	4/10	4/10	4/10
Max. pre-fuses	[-]/UL ¹⁾ [A]	3	4	5	6
Efficiency ³⁾		0.96	0.96	0.96	0.96
Weight IP 20 EB	[kg]	10.5	10.5	10.5	10.5
Power loss at max. load.	[W]	63	71	102	129
Enclosure		IP 20 / Nema 1			

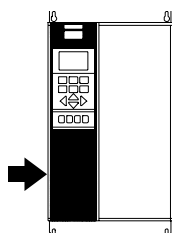
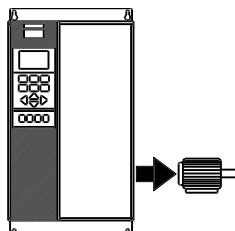

1. For type of fuses see section *Fuses*.

2. American Wire Gauge.

3. Measured using 30 m screened motor cables at rated load and rated frequency.

Compact, Mains supply 3 x 525 - 600 V

According to international requirements	VLT type	5005	5006	5008	5011
Normal overload torque (110 %):					
Output current	$I_{VLT,N}$ [A] (550 V)	6.4	9.5	11.5	11.5
	$I_{VLT,MAX}$ (60 s) [A] (550 V)	7.0	10.5	12.7	12.7
	$I_{VLT,N}$ [A] (575 V)	6.1	9.0	11.0	11.0
	$I_{VLT,MAX}$ (60 s) [A] (575 V)	6.7	9.9	12.1	12.1
Output	$S_{VLT,N}$ [kVA] (550 V)	6.1	9.0	11.0	11.0
	$S_{VLT,N}$ [kVA] (575 V)	6.1	9.0	11.0	11.0
Typical shaft output	$P_{VLT,N}$ [kW]	4	5.5	7.5	7.5
Typical shaft output	$P_{VLT,N}$ [HP]	5	7.5	10.0	10.0
High overload torque (160%):					
Output current	$I_{VLT,N}$ [A] (550 V)	5.2	6.4	9.5	11.5
	$I_{VLT,MAX}$ (60 s) [A] (550 V)	8.3	10.2	15.2	18.4
	$I_{VLT,N}$ [A] (575 V)	4.9	6.1	9.0	11.0
	$I_{VLT,MAX}$ (60 s) [A] (575 V)	7.8	9.8	14.4	17.6
Output	$S_{VLT,N}$ [kVA] (550 V)	5.0	6.1	9.0	11.0
	$S_{VLT,N}$ [kVA] (575 V)	4.9	6.1	9.0	11.0
Typical shaft output	$P_{VLT,N}$ [kW]	3	4	5.5	7.5
Typical shaft output	$P_{VLT,N}$ [HP]	4	5	7.5	10
Max. cable cross-section to motor, brake and loadsharing [mm ²]/[AWG] ²		4/10	4/10	4/10	4/10

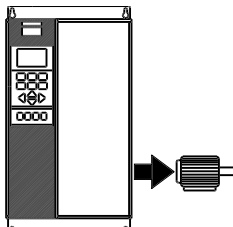

Normal overload torque (110 %):

Rated input current	$I_{L,N}$ [A] (550 V)	6.2	9.2	11.2	11.2
	$I_{L,N}$ [A] (600 V)	5.7	8.4	10.3	10.3

High overload torque (160 %):

Rated input current	$I_{L,N}$ [A] (550 V)	5.1	6.2	9.2	11.2
	$I_{L,N}$ [A] (600 V)	4.6	5.7	8.4	10.3
Max. cable cross-section, power [mm ²]/[AWG] ²		4/10	4/10	4/10	4/10
Max. pre-fuses	[-/UL ¹] [A]	8	10	15	20
Efficiency ³⁾		0.96	0.96	0.96	0.96
Weight IP 20 EB	[kg]	10.5	10.5	10.5	10.5
Power loss at max. load.	[W]	160	236	288	288
Enclosure		IP 20 / Nema 1			

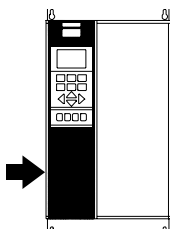

1. For type of fuses see section *Fuses*.
2. American Wire Gauge.
3. Measured using 30 m screened motor cables at rated load and rated frequency.

VLT® 5000 Series

■ Compact, Mains supply 3 x 525 - 600 V

According to international requirements

	VLT type	5016	5022	5027
Normal overload torque (110 %):				
Output current	$I_{VLT,N}$ [A] (550 V)	23	28	34
	$I_{VLT,MAX}$ (60 s) [A] (550 V)	25	31	37
Output	$I_{VLT,N}$ [A] (575 V)	22	27	32
	$I_{VLT,MAX}$ (60 s) [A] (575 V)	24	30	35
	$S_{VLT,N}$ [kVA] (550 V)	22	27	32
	$S_{VLT,N}$ [kVA] (575 V)	22	27	32
Typical shaft output	$P_{VLT,N}$ [kW]	15	18.5	22
Typical shaft output	$P_{VLT,N}$ [HP]	20	25	30
High overload torque (160 %):				
Output current	$I_{VLT,N}$ [A] (550 V)	18	23	28
	$I_{VLT,MAX}$ (60 s) [A] (550 V)	29	37	45
	$I_{VLT,N}$ [A] (575 V)	17	22	27
	$I_{VLT,MAX}$ (60 s) [A] (575 V)	27	35	43
Output	$S_{VLT,N}$ [kVA] (550 V)	17	22	27
	$S_{VLT,N}$ [kVA] (575 V)	17	22	27
Typical shaft output	$P_{VLT,N}$ [kW]	11	15	18.5
Typical shaft output	$P_{VLT,N}$ [HP]	15	20	25
Max. cable cross-section to motor, brake and loadsharing [mm ²]/[AWG] ²⁾		16	16	35
Min. cable cross-section to motor, brake and loadsharing [mm ²]/[AWG] ⁴⁾		0.5	0.5	10
		20	20	8
Normal overload torque (110 %):				
Rated input current	$I_{L,N}$ [A] (550 V)	22	27	33
	$I_{L,N}$ [A] (600 V)	21	25	30
High overload torque (160 %):				
Rated input current	$I_{L,N}$ [A] (550 V)	18	22	27
	$I_{L,N}$ [A] (600 V)	16	21	25
Max. cable cross-section, power [mm ²]/[AWG] ²⁾		16	16	35
		6	6	2
Max. pre-fuses	[·]/UL ¹⁾ [A]	30	35	45
Efficiency ³⁾		0.96	0.96	0.96
Weight IP 20 EB	[kg]	23	23	30
Power loss at max. load	[W]	576	707	838
Enclosure		IP 20 / Nema 1		

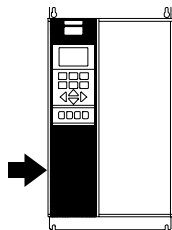
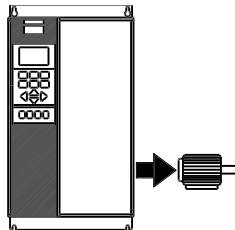

1. For type of fuse see section *Fuses*

2. American Wire Gauge.

3. Measured using 30 m screened motor cables at rated load and rated frequency.

4. Min. cable cross-section is the smallest cable cross-section allowed to be fitted on the terminals to comply with IP 20. Always comply with national and local regulations on min. cable cross-section.

Compact, Mains supply 3 x 525 - 600 V

According to international requirements

	VLT type	5032	5042	5052	5062
Normal overload torque (110 %):					
Output current	$I_{VLT,N}$ [A] (550 V)	43	54	65	81
	$I_{VLT,MAX}$ (60 s) [A] (550 V)	47	59	72	89
	$I_{VLT,N}$ [A] (575 V)	41	52	62	77
	$I_{VLT,MAX}$ (60 s) [A] (575 V)	45	57	68	85
Output	$S_{VLT,N}$ [kVA] (550 V)	41	51	62	77
	$S_{VLT,N}$ [kVA] (575 V)	41	52	62	77
Typical shaft output	$P_{VLT,N}$ [kW]	30	37	45	55
Typical shaft output	$P_{VLT,N}$ [HP]	40	50	60	75
High overload torque (160 %):					
Output current	$I_{VLT,N}$ [A] (550 V)	34	43	54	65
	$I_{VLT,MAX}$ (60 s) [A] (550 V)	54	69	86	104
	$I_{VLT,N}$ [A] (575 V)	32	41	52	62
	$I_{VLT,MAX}$ (60 s) [A] (575 V)	51	66	83	99
Output	$S_{VLT,N}$ [kVA] (550 V)	32	41	51	62
	$S_{VLT,N}$ [kVA] (575 V)	32	41	52	62
Typical shaft output	$P_{VLT,N}$ [kW]	22	30	37	45
Typical shaft output	$P_{VLT,N}$ [HP]	30	40	50	60
Max. cable cross-section to motor, brake and loadsharing [mm ²]/[AWG] ^{2) 5)}		35	50	50	50
Min. cable cross-section to motor, brake and loadsharing [mm ²]/[AWG] ⁴⁾		2	1/0	1/0	1/0
		10	16	16	16
		8	6	6	6
Normal overload torque (110 %):					
Rated input current	$I_{L,N}$ [A] (550 V)	42	53	63	79
	$I_{L,N}$ [A] (600 V)	38	49	58	72
High overload torque (160 %):					
Rated input current	$I_{L,N}$ [A] (550 V)	33	42	53	63
	$I_{L,N}$ [A] (600 V)	30	38	49	58
Max. cable cross-section power [mm ²]/[AWG] ^{2) 5)}		35	50	50	50
		2	1/0	1/0	1/0
Max. pre-fuses	$[-]/UL^{1)}$ [A]	60	75	90	100
Efficiency ³⁾		0.96	0.96	0.96	0.96
Weight IP 20 EB	[kg]	30	48	48	48
Power loss at max. load	[W]	1074	1362	1624	2016
Enclosure		IP 20 / Nema 1			

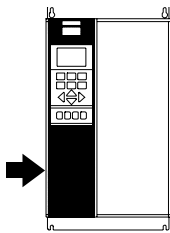
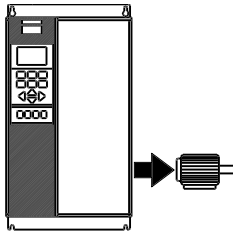
 1. For type of fuse see section *Fuses*

2. American Wire Gauge.

3. Measured using 30 m screened motor cables at rated load and rated frequency.

4. Min. cable cross-section is the smallest cable cross-section allowed to be fitted on the terminals to comply with IP 20. Always comply with national and local regulations on min. cable cross-section.

 5. Aluminium cables with cross-section above 35 mm² must be connected by use of a Al-Cu connector.

■ Mains supply 3 x 525 - 690 V

According to international requirements		VLT type	5042	5052	5062	5072	5102
Normal overload torque (110 %):							
Output current	$I_{VLT,N}$ [A] (525-550 V)		56	76	90	113	137
	$I_{VLT,MAX}$ (60 s) [A] (525-550 V)		62	84	99	124	151
	$I_{VLT,N}$ [A] (551-690 V)		54	73	86	108	131
	$I_{VLT,MAX}$ (60 s) [A] (551-690 V)		59	80	95	119	144
Output	$S_{VLT,N}$ [kVA] (550 V)		53	72	86	108	131
	$S_{VLT,N}$ [kVA] (575 V)		54	73	86	108	130
	$S_{VLT,N}$ [kVA] (690 V)		65	87	103	129	157
Typical shaft output	[kW] (550 V)		37	45	55	75	90
	[HP] (575 V)		50	60	75	100	125
	[kW] (690 V)		45	55	75	90	110
High overload torque (160 %):							
Output current	$I_{VLT,N}$ [A] (525-550 V)		48	56	76	90	113
	$I_{VLT,MAX}$ (60 s) [A] (525-550 V)		77	90	122	135	170
	$I_{VLT,N}$ [A] (551-690 V)		46	54	73	86	108
	$I_{VLT,MAX}$ (60 s) [A] (551-690 V)		74	86	117	129	162
Output	$S_{VLT,N}$ [kVA] (550 V)		46	53	72	86	108
	$S_{VLT,N}$ [kVA] (575 V)		46	54	73	86	108
	$S_{VLT,N}$ [kVA] (690 V)		55	65	87	103	129
Typical shaft output	[kW] (550 V)		30	37	45	55	75
	[HP] (575 V)		40	50	60	75	100
	[kW] (690 V)		37	45	55	75	90
Max. cable cross-section to motor	[mm ²] ^{4,6}				2 x 70		
	[AWG] ^{2,4,6}				2 x 2/0		
Max. cable cross-section to loadsharing and brake	[mm ²] ^{4,6}				2 x 70		
	[AWG] ^{2,4,6}				2 x 2/0		
Normal overload torque (110 %):							
Rated input current	$I_{L,N}$ [A] (550 V)	60	77	89	110	130	
	$I_{L,N}$ [A] (575 V)	58	74	85	106	124	
	$I_{L,N}$ [A] (690 V)	58	77	87	109	128	
High overload torque (160 %):							
Rated input current	$I_{L,N}$ [A] (550 V)	53	60	77	89	110	
	$I_{L,N}$ [A] (575 V)	51	58	74	85	106	
	$I_{L,N}$ [A] (690 V)	50	58	77	87	109	
Max. cable cross-section power supply	[mm ²] ^{4,6}				2 x 70		
	[AWG] ^{2,4,6}				2 x 2/0		
Max. pre-fuses (mains) [-]/UL	[A] ¹	125	160	200	200	250	
Efficiency ³		0.97	0.97	0.98	0.98	0.98	
Power loss	Normal overload [W]	1458	1717	1913	2262	2662	
	High overload [W]	1355	1459	1721	1913	2264	
Weight	IP 00 [kg]			82			
Weight	IP 21/Nema1 [kg]			96			
Weight	IP 54/Nema12 [kg]			96			
Enclosure		IP 00, IP 21/Nema 1 and IP 54/Nema12					

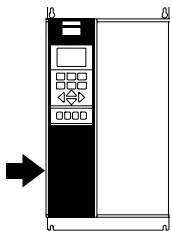
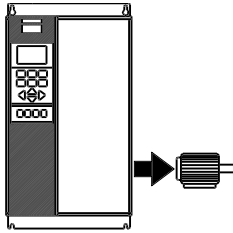

1. For type of fuse see section *Fuses*
2. American Wire Gauge.
3. Measured using 30 m screened motor cables at rated load and rated frequency.
4. Max. cable cross-section is the maximum possible cable cross-section allowed to be fitted on the terminals. Always comply with national and local regulations on min. cable cross-section.
5. Weight without shipping container.
6. Connection bolt power supply and motor: M10; Brake and loadsharing: M8

■ mains supply 3 x 525 - 690 V

According to international requirements		VLT type	5122	5152	5202	5252	5302	5352
Normal overload torque (110 %):								
Output current	I _{VLT,N} [A] (525-550 V)	162	201	253	303	360	418	
	I _{VLT,MAX} (60 s) [A] (525-550 V)	178	221	278	333	396	460	
	I _{VLT,N} [A] (551-690 V)	155	192	242	290	344	400	
	I _{VLT,MAX} (60 s) [A] (551-690 V)	171	211	266	319	378	440	
Output	S _{VLT,N} [kVA] (550 V)	154	191	241	289	343	398	
	S _{VLT,N} [kVA] (575 V)	154	191	241	289	343	398	
	S _{VLT,N} [kVA] (690 V)	185	229	289	347	411	478	
Typical shaft output	[kW] (550 V)	110	132	160	200	250	315	
	[HP] (575 V)	150	200	250	300	350	400	
	[kW] (690 V)	132	160	200	250	315	400	
High overload torque (160 %):								
Output current	I _{VLT,N} [A] (525-550 V)	137	162	201	253	303	360	
	I _{VLT,MAX} (60 s) [A] (525-550 V)	206	243	302	380	455	540	
	I _{VLT,N} [A] (551-690 V)	131	155	192	242	290	344	
	I _{VLT,MAX} (60 s) [A] (551-690 V)	197	233	288	363	435	516	
Output	S _{VLT,N} [kVA] (550 V)	131	154	191	241	289	343	
	S _{VLT,N} [kVA] (575 V)	130	154	191	241	289	343	
	S _{VLT,N} [kVA] (690 V)	157	185	229	289	347	411	
Typical shaft output	[kW] (550 V)	90	110	132	160	200	250	
	[HP] (575 V)	125	150	200	250	300	350	
	[kW] (690 V)	110	132	160	200	250	315	
Max. cable cross-section to motor	[mm ²] ^{4,6}	2 x 70				2 x 185		
	[AWG] ^{2,4,6}	2 x 2/0				2 x 350 mcm		
Max. cable cross-section to loadsharing and brake	[mm ²] ^{4,6}	2 x 70				2 x 185		
	[AWG] ^{2,4,6}	2 x 2/0				2 x 350 mcm		
Normal overload torque (110 %):								
Rated input current	I _{L,N} [A] (550 V)	158	198	245	299	355	408	
	I _{L,N} [A] (575 V)	151	189	234	286	339	390	
	I _{L,N} [A] (690 V)	155	197	240	296	352	400	
High overload torque (160 %):								
Rated input current	I _{L,N} [A] (550 V)	130	158	198	245	299	355	
	I _{L,N} [A] (575 V)	124	151	189	234	286	339	
	I _{L,N} [A] (690 V)	128	155	197	240	296	352	
Max. cable cross-section power supply	[mm ²] ^{4,6}	2 x 70				2 x 185		
	[AWG] ^{2,4,6}	2 x 2/0				2 x 350 mcm		
Max. pre-fuses (mains) [-]/UL	[A] ¹	315	350	350	400	500	550	
Efficiency ³					0,98			
Power loss	Normal overload [W]	3114	3612	4292	5155	5821	6149	
	High overload [W]	2664	2952	3451	4275	4875	5185	
Weight	IP 00 [kg]	82	91	112	123	138	151	
Weight	IP 21/Nema1 [kg]	96	104	125	136	151	165	
Weight	IP 54/Nema12 [kg]	96	104	125	136	151	165	
Enclosure		IP 00, IP 21/Nema 1 and IP 54/Nema12						

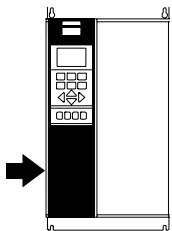
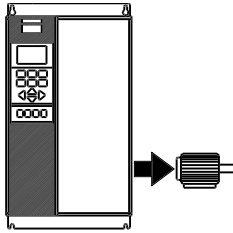

1. For type of fuse see section *Fuses*

2. American Wire Gauge.

3. Measured using 30 m screened motor cables at rated load and rated frequency.

4. Max. cable cross-section is the maximum possible cable cross-section allowed to be fitted on the terminals. Always comply with national and local regulations on min. cable cross-section.

5. Weight without shipping container.

6. Connection bolt power supply and motor: M10; Brake and loadsharing: M8

■ Compact, Mains supply 3 x 525 - 690 V

According to international requirements		VLT type	5402	5502	5602
Normal overload current (110 %):					
Output current	$I_{VLT,N}$ [A] (525-550 V)		523	596	630
	$I_{VLT,MAX}$ (60 s) [A] (525-550 V)		575	656	693
	$I_{VLT,N}$ [A] (551-690 V)		500	570	630
	$I_{VLT,MAX}$ (60 s) [A] (551-690 V)		550	627	693
Output	$S_{VLT,N}$ [kVA] (550 V)		498	568	600
	$S_{VLT,N}$ [kVA] (575 V)		498	568	627
	$S_{VLT,N}$ [kVA] (690 V)		598	681	753
	Typical shaft output	[kW] (550 V)	400	450	500
	[HP] (575 V)	500	600	650	
	[kW] (690 V)	500	560	630	
High overload torque (160 %):					
Output current	$I_{VLT,N}$ [A] (525-550 V)		429	523	596
	$I_{VLT,MAX}$ (60 s) [A] (525-550 V)		644	785	894
	$I_{VLT,N}$ [A] (551-690 V)		410	500	570
	$I_{VLT,MAX}$ (60 s) [A] (551-690 V)		615	750	855
Output	$S_{VLT,N}$ [kVA] (550 V)		409	498	568
	$S_{VLT,N}$ [kVA] (575 V)		408	498	568
	$S_{VLT,N}$ [kVA] (690 V)		490	598	681
	Typical shaft output	[kW] (550 V)	315	400	450
	[HP] (575 V)	400	500	600	
	[kW] (690 V)	400	500	560	
Max. cable cross-section to motor and loadsharing	[mm ²] ^{4,6}		4x240		
	[AWG] ^{2,4,6}		4x500 mcm		
Max. cable cross-section to brake	[mm ²] ^{4,6}		2x185		
	[AWG] ^{2,4,6}		2x350 mcm		
Normal overload current (110 %):					
Rated input current	$I_{L,N}$ [A] (525-550 V)		504	574	607
	$I_{L,N}$ [A] (551-690 V)		482	549	607
High overload torque (160 %):					
Rated input current	$I_{L,N}$ [A] (525-550 V)		413	504	574
	$I_{L,N}$ [A] (551-690 V)		395	482	549
Max. cable cross-section power supply	[mm ²] ^{4,6}		4x240		
	[AWG] ^{2,4,6}		4x500 mcm		
Max. pre-fuses (mains) [-]/UL	[A] ¹	700/700	900/900	900/900	
Efficiency ³			0,98		
Power loss	Normal overload [W]	7249	8727	9673	
	High overload [W]	5818	7671	8715	
Weight	IP 00 [kg]	221	236	277	
Weight	IP 21/Nema1 [kg]	263	272	313	
Weight	IP 54/Nema12 [kg]	263	272	313	
Enclosure		IP 00, IP 21/Nema 1 and IP 54/Nema12			

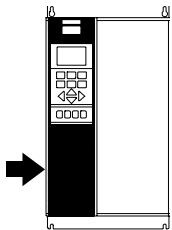
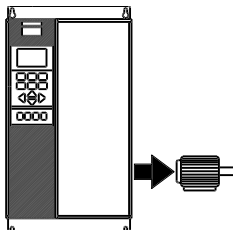

1. For type of fuse see section *Fuses*
2. American Wire Gauge.
3. Measured using 30 m screened motor cables at rated load and rated frequency.
4. Max. cable cross-section is the maximum possible cable cross-section allowed to be fitted on the terminals. Always comply with national and local regulations on min. cable cross-section.
5. Weight without shipping container.
6. Connection bolt power supply, motor and loadsharing: M10 (compression lug), 2xM8 (box lug), M8 (brake)

■ Fuses
UL compliance

To comply with UL/cUL approvals, pre-fuses according to the table below must be used.

200-240 V

VLT	Bussmann	SIBA	Littel fuse	Ferraz-Shawmut
5001	KTN-R10	5017906-010	KLN-R10	ATM-R10 or A2K-10R
5002	KTN-R10	5017906-010	KLN-R10	ATM-R10 or A2K-10R
5003	KTN-R25	5017906-016	KLN-R15	ATM-R15 or A2K-15R
5004	KTN-R20	5017906-020	KLN-R20	ATM-R20 or A2K-20R
5005	KTN-R25	5017906-025	KLN-R25	ATM-R25 or A2K-25R
5006	KTN-R30	5012406-032	KLN-R30	ATM-R30 or A2K-30R
5008	KTN-R50	5014006-050	KLN-R50	A2K-50R
5011	KTN-R60	5014006-063	KLN-R60	A2K-60R
5016	KTN-R85	5014006-080	KLN-R80	A2K-80R
5022	KTN-R125	2028220-125	KLN-R125	A2K-125R
5027	KTN-R125	2028220-125	KLN-R125	A2K-125R
5032	KTN-R150	2028220-160	L25S-150	A25X-150
5042	KTN-R200	2028220-200	L25S-200	A25X-200
5052	KTN-R250	2028220-250	L25S-250	A25X-250

380-500 V

VLT	Bussmann	SIBA	Littel fuse	Ferraz-Shawmut
5001	KTS-R6	5017906-006	KLS-R6	ATM-R6 or A6K-6R
5002	KTS-R6	5017906-006	KLS-R6	ATM-R6 or A6K-6R
5003	KTS-R10	5017906-010	KLS-R10	ATM-R10 or A6K-10R
5004	KTS-R10	5017906-010	KLS-R10	ATM-R10 or A6K-10R
5005	KTS-R15	5017906-016	KLS-R16	ATM-R16 or A6K-16R
5006	KTS-R20	5017906-020	KLS-R20	ATM-R20 or A6K-20R
5008	KTS-R25	5017906-025	KLS-R25	ATM-R25 or A6K-25R
5011	KTS-R30	5012406-032	KLS-R30	A6K-30R
5016	KTS-R40	5012406-040	KLS-R40	A6K-40R
5022	KTS-R50	5014006-050	KLS-R50	A6K-50R
5027	KTS-R60	5014006-063	KLS-R60	A6K-60R
5032	KTS-R80	2028220-100	KLS-R80	A6K-180R
5042	KTS-R100	2028220-125	KLS-R100	A6K-100R
5052	KTS-R125	2028220-125	KLS-R125	A6K-125R
5062	KTS-R150	2028220-160	KLS-R150	A6K-150R
5072	FWH-220	2028220-200	L50S-225	A50-P225
5102	FWH-250	2028220-250	L50S-250	A50-P250
5122*	FWH-300/170M3017	2028220-315	L50S-300	A50-P300
5152*	FWH-350/170M3018	2028220-315	L50S-350	A50-P350
5202*	FWH-400/170M4012	206xx32-400	L50S-400	A50-P400
5252*	FWH-500/170M4014	206xx32-500	L50S-500	A50-P500
5302*	FWH-600/170M4016	206xx32-600	L50S-600	A50-P600
5352	170M4017	2061032,700		6.9URD31D08A0700
5452	170M6013	2063032,900		6.9URD33D08A0900
5502	170M6013	2063032,900		6.9URD33D08A0900
5552	170M6013	2063032,900		6.9URD33D08A0900

* Circuit Breakers manufactured by General Electric, Cat. No. SKHA36AT0800, with rating plugs listed below can be used to meet UL-requirements:

5122	rating plug No.	SRPK800 A 300
5152	rating plug No.	SRPK800 A 400
5202	rating plug No.	SRPK800 A 400
5252	rating plug No.	SRPK800 A 500
5302	rating plug No.	SRPK800 A 600

525-600 V

	Bussmann	SIBA	Littel fuse	Ferraz-Shawmut
5001	KTS-R3	5017906-004	KLS-R003	A6K-3R
5002	KTS-R4	5017906-004	KLS-R004	A6K-4R
5003	KT-R5	5017906-005	KLS-R005	A6K-5R
5004	KTS-R6	5017906-006	KLS-R006	A6K-6R
5005	KTS-R8	5017906-008	KLS-R008	A6K-8R
5006	KTS-R10	5017906-010	KLS-R010	A6K-10R
5008	KTS-R15	5017906-016	KLS-R015	A6K-15R
5011	KTS-R20	5017906-020	KLS-R020	A6K-20R
5016	KTS-R30	5017906-030	KLS-R030	A6K-30R
5022	KTS-R35	5014006-040	KLS-R035	A6K-35R
5027	KTS-R45	5014006-050	KLS-R045	A6K-45R
5032	KTS-R60	5014006-063	KLS-R060	A6K-60R
5042	KTS-R75	5014006-080	KLS-R075	A6K-80R
5052	KTS-R90	5014006-100	KLS-R090	A6K-90R
5062	KTS-R100	5014006-100	KLS-R100	A6K-100R

525-600 V (UL) and 525-690 V (CE) drives

	Bussmann	SIBA	FERRAZ-SHAWMUT
5042	170M3013	2061032,125	6.6URD30D08A0125
5052	170M3014	2061032,16	6.6URD30D08A0160
5062	170M3015	2061032,2	6.6URD30D08A0200
5072	170M3015	2061032,2	6.6URD30D08A0200
5102	170M3016	2061032,25	6.6URD30D08A0250
5122	170M3017	2061032,315	6.6URD30D08A0315
5152	170M3018	2061032,35	6.6URD30D08A0350
5202	170M4011	2061032,35	6.6URD30D08A0350
5252	170M4012	2061032,4	6.6URD30D08A0400
5302	170M4014	2061032,5	6.6URD30D08A0500
5352	170M5011	2062032,55	6.6URD32D08A550
5402	170M4017	2061032,700	6.9URD31D08A0700
5502	170M6013	2063032,900	6.9URD33D08A0900
5602	170M6013	2063032,900	6.9URD33D08A0900

KTS-fuses from Bussmann may substitute KTN for 240 V drives.

FWH-fuses from Bussmann may substitute FWX for 240 V drives.

KLSR fuses from LITTEL FUSE may substitute KLNR fuses for 240 V drives.

L50S fuses from LITTEL FUSE may substitute L25S fuses for 240 V drives.

A6KR fuses from FERRAZ SHAWMUT may substitute A2KR for 240 V drives.

A50X fuses from FERRAZ SHAWMUT may substitute A25X for 240 V drives.

Non UL compliance

If UL/cUL is not to be complied with, we recommend the above mentioned fuses or:

VLT 5001-5027	200-240 V	type gG
VLT 5032-5052	200-240 V	type gR
VLT 5001-5062	380-500 V	type gG
VLT 5072-5102	380-500 V	type gR
VLT 5122-5302	380-500 V	type gG
VLT 5352-5552	380-500 V	type gR
VLT 5001-5062	525-600 V	type gG

Not following the recommendation may result in unnecessary damage of the drive in case of malfunction. Fuses must be designed for protection in a circuit capable of supplying a maximum of 100000 A_{rms} (symmetrical), 500/600 V maximum.

■ Mechanical dimensions

All the below listed measurements are in mm.

	A	B	C	D	a	b	ab/be	Type
Bookstyle IP 20								
5001 - 5003 200 - 240 V	395	90	260		384	70	100	A
5001 - 5005 380 - 500 V								
5004 - 5006 200 - 240 V	395	130	260		384	70	100	A
5006 - 5011 380 - 500 V								
Compact IP 00								
5032 - 5052 200 - 240 V	800	370	335		780	270	225	B
5122 - 5152 380 - 500 V	1046	408	373 ¹⁾		1001	304	225	J
5202 - 5302 380 - 500 V	1327	408	373 ¹⁾		1282	304	225	J
5352 - 5552 380 - 500 V	1547	585	494 ¹⁾		1502	304	225	I
5042 - 5152 525 - 690 V	1046	408	373 ¹⁾		1001	304	225	J
5202 - 5352 525 - 690 V	1327	408	373 ¹⁾		1282	304	225	J
5402 - 5602 525 - 690 V	1547	585	494 ¹⁾		1502	304	225	I
Compact IP 20								
5001 - 5003 200 - 240 V	395	220	160		384	200	100	C
5001 - 5005 380 - 500 V								
5004 - 5006 200 - 240 V	395	220	200		384	200	100	C
5006 - 5011 380 - 500 V								
5001 - 5011 525 - 600 V (IP 20 and Nema 1)								
5008 200 - 240 V								
5016 - 5022 380 - 500 V	560	242	260		540	200	200	D
5016 - 5022 525 - 600 V (Nema 1)								
5011 - 5016 200 - 240 V	700	242	260		680	200	200	D
5027 - 5032 380 - 500 V								
5027 - 5032 525 - 600 V (Nema 1)								
5022 - 5027 200 - 240 V	800	308	296		780	270	200	D
5042 - 5062 380 - 500 V								
5042 - 5062 525 - 600 V (Nema 1)								
5072 - 5102 380 - 500 V	800	370	335		780	330	225	D
Compact Nema 1/IP20/IP21								
5032 - 5052 200 - 240 V	954	370	335		780	270	225	E
5122 - 5152 380 - 500 V	1208	420	373 ¹⁾		1154	304	225	J
5202 - 5302 380 - 500 V	1588	420	373 ¹⁾		1535	304	225	J
5352 - 5552 380 - 500 V	2000	600	494 ¹⁾		-	-	225	H
5042 - 5152 525 - 690 V	1208	420	373 ¹⁾		1154	304	225	J
5202 - 5352 525 - 690 V	1588	420	373 ¹⁾		1535	304	225	J
5402 - 5602 525 - 690 V	2000	600	494 ¹⁾		-	-	225	H
Compact IP 54/Nema 12								
5001 - 5003 200 - 240 V	460	282	195	85	260	258	100	F
5001 - 5005 380 - 500 V								
5004 - 5006 200 - 240 V	530	282	195	85	330	258	100	F
5006 - 5011 380 - 500 V								
5008 - 5011 200 - 240 V	810	350	280	70	560	326	200	F
5016 - 5027 380 - 500 V								
5016 - 5027 200 - 240 V	940	400	280	70	690	375	200	F
5032 - 5062 380 - 500 V								
5032 - 5052 200 - 240 V	937	495	421	-	830	374	225	G
5072 - 5102 380 - 500 V	940	400	360	70	690	375	225	F
5122 - 5152 380 - 500 V	1208	420	373 ¹⁾	-	1154	304	225	J
5202 - 5302 380 - 500 V	1588	420	373 ²⁾		1535	304	225	J
5352 - 5552 380 - 500 V	2000	600	494 ¹⁾	-	-	-	225	H
5042 - 5152 525 - 690 V	1208	420	373 ¹⁾	-	1154	304	225	J
5202 - 5352 525 - 690 V	1588	420	373 ¹⁾		1535	304	225	J
5402 - 5602 525 - 690 V	2000	600	494 ¹⁾		-	-	225	H

 ab: Minimum space above enclosure¹⁾

be: Minimum space below enclosure

1) With disconnect, add 44 mm.

■ Mechanical dimensions, cont.

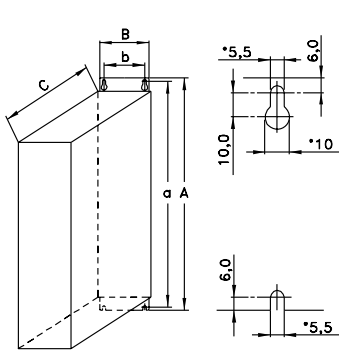

Type A, IP20

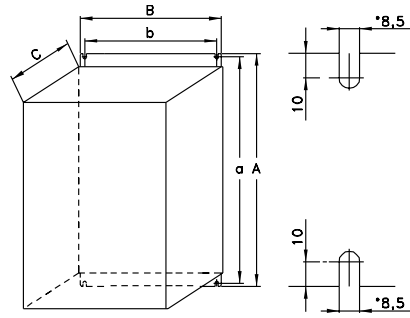

Type D, IP20

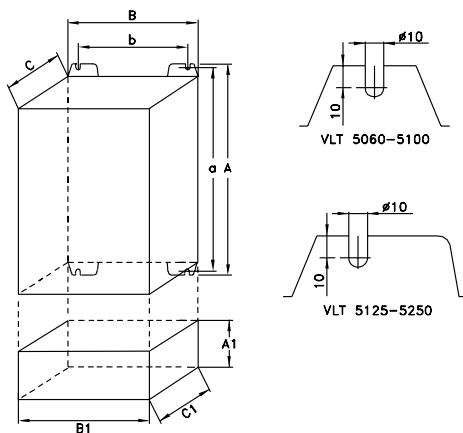

Type B, IP00
With option and enclosure IP20

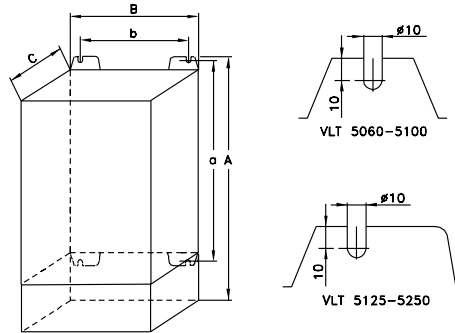

Type E, IP20/NEMA 1 with terminals

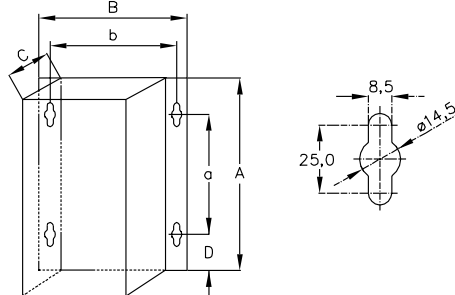

Type F, IP54

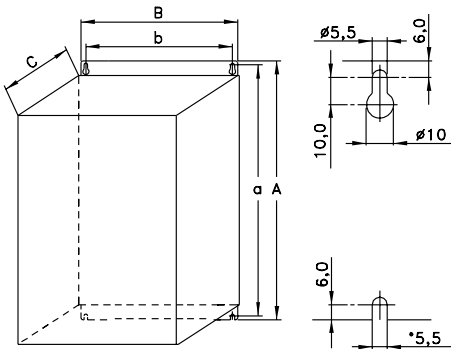

Type C, IP20

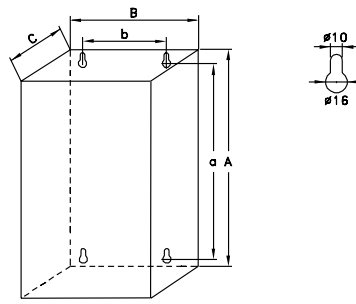

Type G, IP54

175ZA577.12

■ Mechanical dimensions (cont.)

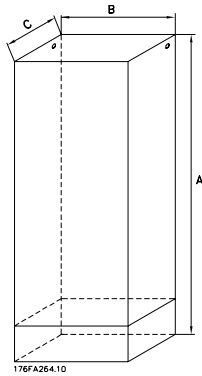

Type H, IP 20, IP 54

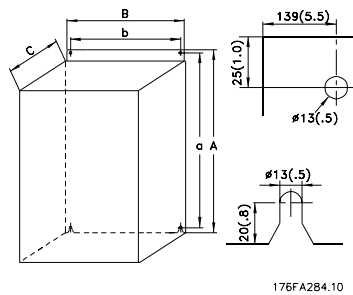

Type I, IP 00

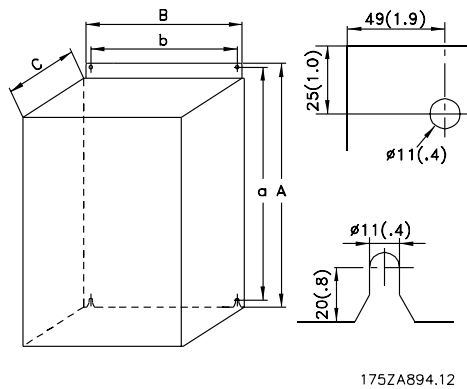

Type J, IP 00, IP 21, IP 54

■ Mechanical installation

Please pay attention to the requirements that apply to integration and field mounting kit, see the below list. The information given in the list must be observed to avoid serious damage or injury, especially when installing large units.

The frequency converter *must* be installed vertically.

The frequency converter is cooled by means of air circulation. For the unit to be able to release its cooling air, the *minimum* distance over and below the unit must be as shown in the illustration below.

To protect the unit from overheating, it must be ensured that the ambient temperature *does not rise above the max. temperature stated for the frequency converter and that the 24-hour average temperature is not exceeded* . The max. temperature and 24-hour average can be seen from the *General Technical Data*.

If the ambient temperature is in the range of 45°C -55° C, derating of the frequency converter will become relevant, see *Derating for ambient temperature*.

The service life of the frequency converter will be reduced if derating for ambient temperature is not taken into account.

■ Installation of VLT 5001-5602

All frequency converters must be installed in a way that ensures proper cooling.

Cooling

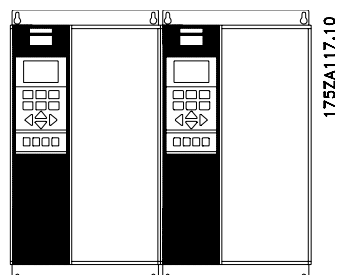
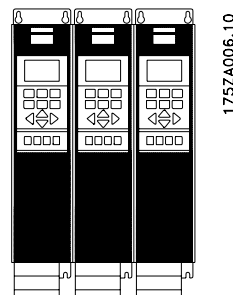
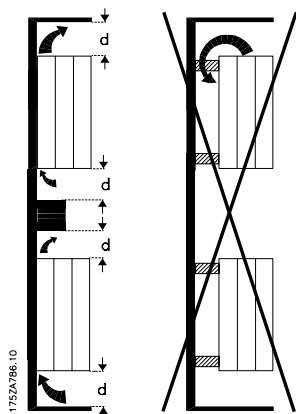

All Bookstyle and Compact units require a minimum space above and below the enclosure.

Side by side/flange by flange

All frequency converters can be mounted side by side/flange by flange.

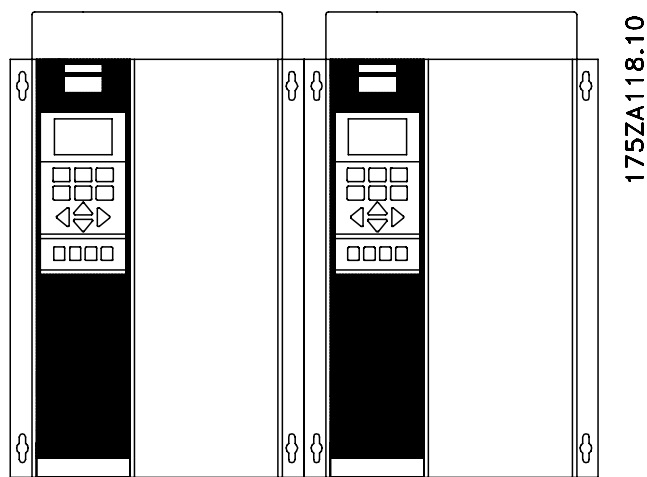

	d [mm]	Comments
Bookstyle		
VLT 5001-5006, 200-240 V	100	Installation on a plane, vertical surface (no spacers)
VLT 5001-5011, 380-500 V	100	
Compact (all enclosure types)		
VLT 5001-5006, 200-240 V	100	Installation on a plane, vertical surface (no spacers)
VLT 5001-5011, 380-500 V	100	
VLT 5001-5011, 525-600 V	100	
VLT 5008-5027, 200-240 V	200	Installation on a plane, vertical surface (no spacers)
VLT 5016-5062, 380-500 V	200	
VLT 5072-5102, 380-500 V	225	
VLT 5016-5062, 525-600 V	200	
VLT 5032-5052, 200-240 V	225	Installation on a plane, vertical surface (no spacers) IP 54 filter mats must be changed when they are dirty.
VLT 5122-5302, 380-500 V	225	
VLT 5042-5352, 525-690 V	225	
VLT 5352-5552, 380-500 V	225	
VLT 5402-5602, 525-690 V	225	

■ **Installation of VLT 5352-5552 380-500 V and VLT 5402-5602 525-690 V Compact Nema 1 (IP 21) and IP 54**

Cooling

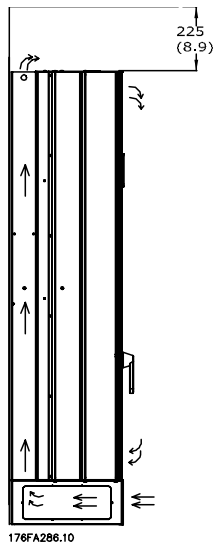

All units in the above-mentioned series require a minimum space of 225 mm above the enclosure and must be installed on a flat level surface. This applies to both Nema 1 (IP 21) and IP 54 units.

Gaining access requires a minimum space of 579 mm in front of the frequency converter.

Filter mats in IP 54 units have to be changed regularly depending on the operating environment.

Side-by-side

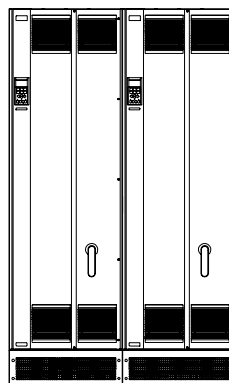

Compact Nema 1 (IP 21) and IP 54

All Nema 1 (IP 21) and IP 54 units in the above-mentioned series can be installed side by side without any space between them, since these units do not require cooling on the sides.

■ Electrical installation



The voltage on the frequency converter is dangerous when the unit is connected to mains. Incorrect installation of the motor or the frequency converter may lead to material damage or serious injury or it may be fatal. Consequently, the instructions in this manual as well as national and local rules and safety regulations must be complied with.

Touching the electrical parts may be fatal, even after the mains supply has been disconnected.

Using VLT 5001-5006, 200-240 V and 380-500 V: wait at least 4 minutes.

Using VLT 5008-5052, 200-240 V: wait at least 15 minutes.

Using VLT 5008-5062, 380-500 V: wait at least 15 minutes.

Using VLT 5072-5302, 380-500 V: wait at least 20 minutes.

Using VLT 5352-5552, 380-500 V: wait at least 40 minutes.

Using VLT 5001-5005, 525-600 V: wait at least 4 minutes.

Using VLT 5006-5022, 525-600 V: wait at least 15 minutes.

Using VLT 5027-5062, 525-600 V: wait at least 30 minutes.

Using VLT 5042-5352, 525-690 V: wait at least 20 minutes.

Using VLT 5402-5602, 525-690 V: wait at least 30 minutes.



NB!

It is the user's or certified electrician's responsibility to ensure correct earthing and protection in accordance with applicable national and local norms and standards.

■ High voltage test

A high voltage test can be carried out by short-circuiting terminals U, V, W, L₁, L₂ and L₃ and energizing by max. 2.15 kV DC for one second between this short-circuit and the chassis.



NB!

The RFI switch must be closed (position ON) when high voltage tests are carried out (see section *RFI Switch*).

The mains and motor connection must be interrupted in the case of high voltage tests of the total installation if the leakage currents are too high.

■ Safety earthing



NB!

The frequency converter has a high leakage current and must be earthed appropriately for safety reasons. Use earth terminal (see section *Electrical installation, power cables*), which enables reinforced earthing.

Apply national safety regulations.

■ Extra protection (RCD)

ELCB relays, multiple protective earthing or earthing can be used as extra protection, provided that local safety regulations are complied with.

In the case of an earth fault, a DC content may develop in the faulty current.

If ELCB relays are used, local regulations must be observed. Relays must be suitable for protection of 3-phase equipment with a bridge rectifier and for a brief discharge on power-up.

See also the section *Special Conditions* in the Design Guide.

■ Electrical installation - mains supply

Connect the three mains phases to terminals L₁, L₂, L₃.

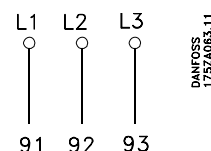

■ Electrical installation - motor cables



NB!

If an unscreened cable is used, some EMC requirements are not complied with, see the Design Guide.

If the EMC specifications regarding emission are to be complied with, the motor cable must be screened, unless otherwise stated for the RFI filter in question. It is important to keep the motor cable as short as possible so as to reduce the noise level and leakage currents to a minimum.

The motor cable screen must be connected to the metal cabinet of the frequency converter and to the metal cabinet of the motor. The screen connections are to be made with the biggest possible surface (cable clamp). This is enabled by different installation devices in the different frequency converters.

Installation with twisted screen ends (pigtailed) is to be avoided, since these spoil the screening effect at higher frequencies.

If it is necessary to break the screen to install a motor isolator or motor contactor, the screen must be continued at the lowest possible HF impedance.

The frequency converter has been tested with a given length of cable and a given cross-section of that cable. If the cross-section is increased, the cable capacitance - and thus the leakage current - increases, and the cable length must be reduced correspondingly.

When frequency converters are used together with LC filters to reduce the acoustic noise from a motor, the switching frequency must be set according to the LC filter instruction in *Parameter 411*. When setting the switching frequency higher than 3 kHz, the output current is derated in SFAVM mode. By changing *Parameter 446* to 60° AVM mode, the frequency at which the current is derated is moved upwards. Please see *Design Guide*.

■ Connection of motor

All types of 3-phased asynchronous standard motors can be used with the VLT 5000 Series.

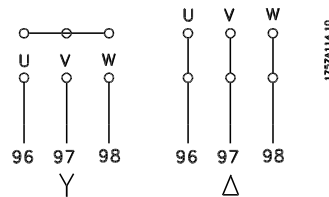

Normally, small motors are star-connected (200/400 V, Δ/Y).

Large motors are delta-connected (400/690 V, Δ/Y).

■ Direction of motor rotation

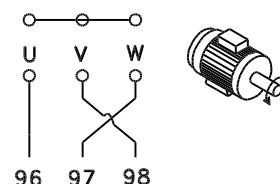
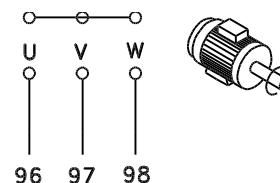

The factory setting is for clockwise rotation with the frequency transformer output connected as follows.

Terminal 96 connected to U-phase
Terminal 97 connected to V-phase
Terminal 98 connected to W-phase

The direction of motor rotation can be changed by switching two phases in the motor cable.

■ Parallel coupling of motors

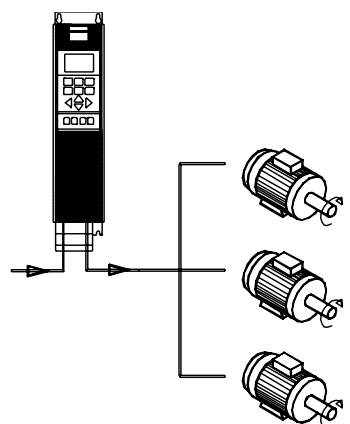

Frequency converters are able to control several motors connected in parallel. If the motors are to have different rpm values, the motors must have different

rated rpm values. Motor rpm is changed simultaneously, which means that the ratio between the rated rpm values is maintained across the range.

The total current consumption of the motors is not to exceed the maximum rated output current $I_{VLT,N}$ for the frequency converter.

Problems may arise at the start and at low rpm values if the motor sizes are widely different. This is because the relatively high ohmic resistance in small motors calls for a higher voltage at the start and at low rpm values.

In systems with motors connected in parallel, the electronic thermal relay (ETR) of the frequency converter cannot be used as motor protection for the individual motor. Consequently, additional motor protection is required, such as thermistors in each motor (or individual thermal relays) suitable for frequency converter use.

Please note that the individual motor cable for each motor must be summed and is not to exceed the total motor cable length permitted.

Motor thermal protection

The electronic thermal relay in UL-approved frequency converters has received the UL-approval for single motor protection when parameter 128 has been set for *ETR Trip* and parameter 105 has been programmed to the rated motor current (see motor nameplate).

Electrical installation - brake cable

(Only standard with brake and extended with brake. Typecode: SB, EB, DE, PB).

No.	Function
81, 82	Brake resistor terminals

The connection cable to the brake resistor must be screened. Connect the screen by means of cable clamps to the conductive back plate at the frequency converter and to the metal cabinet of the brake resistor.

Size the brake cable cross-section to match the brake torque. See also Brake instructions, MI.90.FX.YY and MI.50.SX.YY for further information regarding safe installation.



NB!

Please note that voltages up to 1099 V DC, depending on the supply voltage, may occur on the terminals.

Electrical installation - brake resistor temperature switch

Torque: 0.5-0.6 Nm

Screw size: M3

No.	Function
106, 104, 105	Brake resistor temperature switch.



NB!

This function is only available on VLT 5032-5052, 200-240 V; VLT 5122-5552, 380-500 V; and VLT 5042-5602, 525-690 V.

If the temperature of the brake resistor gets too high and the thermal switch drops out, the frequency converter will stop braking. The motor will start coasting.

A KLIXON switch must be installed that is 'normally closed'. If this function is not used, 106 and 104 must be short-circuited together.

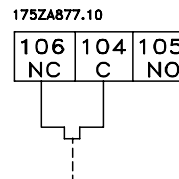

Electrical installation - loadsharing

(Only extended with typecode EB, EX, DE, DX).

No.	Function
88, 89	Loadsharing

Terminals for loadsharing

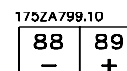

The connection cable must be screened and the max. length from the frequency converter to the DC bar is 25 metres.

Load sharing enables linking of the DC intermediate circuits of several frequency converters.



NB!

Please note that voltages up to 1099 V DC may occur on the terminals.

Load sharing calls for extra equipment. For further information please consult Loadsharing Instructions MI.50.NX.XX.

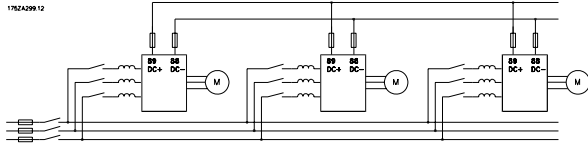

These figures apply to the following terminals:

Mains terminals	Nos	91, 92, 93 L1, L2, L3
Motor terminals	Nos	96, 97, 98 U, V, W
Earth terminal	No	94, 95, 99
Brake resistor terminals		81, 82
Loadsharing		88, 89

■ Tightening-up torques and screw sizes

The table shows the torque required when fitting terminals to the frequency converter. For VLT 5001-5027 200-240 V, VLT 5001-5102 380-500 V and VLT 5001-5062 525-600 V, the cables must be fastened with screws. For VLT 5032 - 5052 200-240 V, VLT 5122-5552 380-500 V, VLT 5042-5602 525-690 V the cables must be fastened with bolts.

VLT type		Torque [Nm]	Screw/ Boltsize	Tool
200-240 V				
5001-5006		0,6	M3	Slotted screw
5008	IP20	1,8	M4	Slotted screw
5008-5011	IP54	1,8	M4	Slotted screw
5011-5022	IP20	3	M5	4 mm Allen wrench
5016-5022 ³¹⁾	IP54	3	M5	4 mm Allen wrench
5027		6	M6	4 mm Allen wrench
5032-5052		11,3	M8 (bolt and stud)	
380-500 V				
5001-5011		0,6	M3	Slotted screw
5016-5022	IP20	1,8	M4	Slotted screw
5016-5027	IP54	1,8	M4	Slotted screw
5027-5042	IP20	3	M5	4 mm Allen wrench
5032-5042 ³⁾	IP54	3	M5	4 mm Allen wrench
5052-5062		6	M6	5 mm Allen wrench
5072-5102	IP20	15	M6	6 mm Allen wrench
	IP54 ²⁾	24	M8	8 mm Allen wrench
5122-5302 ⁴⁾		19	M10 bolt	16 mm wrench
5352-5552 ⁵⁾		19	M10 bolt (compression lug)	16 mm wrench
525-600 V				
5001-5011		0,6	M3	Slotted screw
5016-5027		1,8	M4	Slotted screw
5032-5042		3	M5	4 mm Allen wrench
5052-5062		6	M6	5 mm Allen wrench
525-690 V				
5042-5352 ⁴⁾		19	M10 bolt	16 mm wrench
5402-5602 ⁵⁾		19	M10 bolt (compression lug)	16 mm wrench

1) Brake terminals: 3,0 Nm, Nut: M6

2) Brake and loadsharing: 14 Nm, M6 Allen screw

3) IP54 with RFI - Line terminals 6Nm, Screw: M6 - 5 mm Allen wrench

4) Loadsharing and brake terminals: 9,5 Nm; Bolt M8

5) Brake terminals: 9,5 Nm; Bolt M8.

■ Electrical installation - external fan supply

Torque 0,5-0,6 Nm

Screwsize: M3

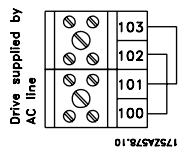
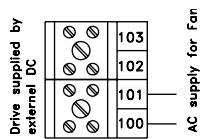

Available in 5122-5552, 380-500 V; 5042-5602, 525-690 V, 5032-5052, 200-240 V in all enclosure types.

Only for IP54 units in the power range VLT 5016-5102, 380-500 V and VLT 5008-5027, 200-240 V AC. If the drive is supplied by the DC bus (loadsharing), the internal fans are not supplied with AC power. In this case they must be supplied with an external AC supply.

Torque: 0.5 - 0.6 Nm

Screw size: M3

No.	Function
1-3	Relay output, 1+3 break, 1+2 make See parameter 323 of the Operating Instructions. See also <i>General technical data</i> .
4, 5	Relay output, 4+5 make See parameter 326 of the Operating Instructions. See also <i>General technical data</i> .

■ Electrical installation - 24 Volt external DC supply

(Only extended versions. Typecode: PS, PB, PD, PF, DE, DX, EB, EX).

Torque: 0.5 - 0.6 Nm

Screw size: M3

No.	Function
35, 36	24 V external DC supply

External 24 V DC supply can be used as low-voltage supply to the control card and any option cards installed. This enables full operation of the LCP (incl. parameter setting) without connection to mains. Please note that a warning of low voltage will be given when 24 V DC has been connected; however, there will be no tripping. If 24 V external DC supply is connected or switched on at the same time as the mains supply, a time of min. 200 msec. must be set in parameter 120 *Start delay*.

A pre-fuse of min. 6 Amp, slow-blow, can be fitted to protect the external 24 V DC supply. The power consumption is 15-50 W, depending on the load on the control card.



NB!

Use 24 V DC supply of type PELV to ensure correct galvanic isolation (type PELV) on the control terminals of the frequency converter.

■ Electrical installation - relay outputs

■ Electrical installation, power cables

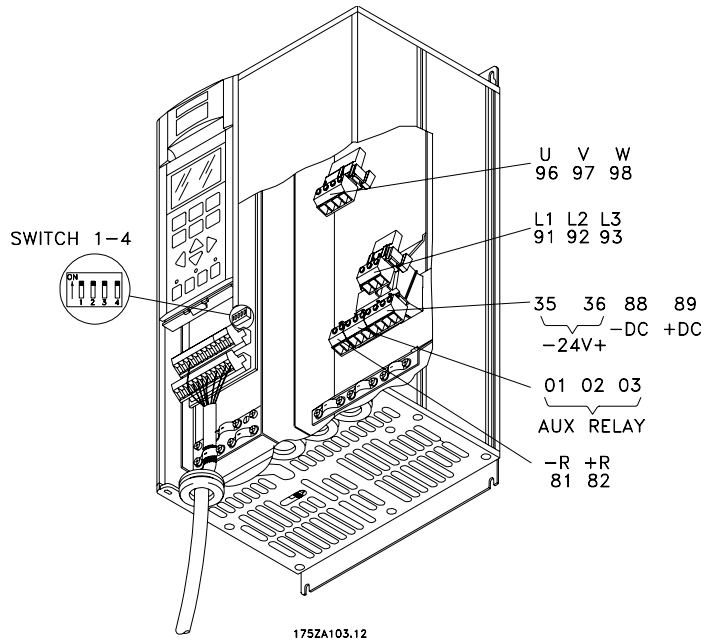
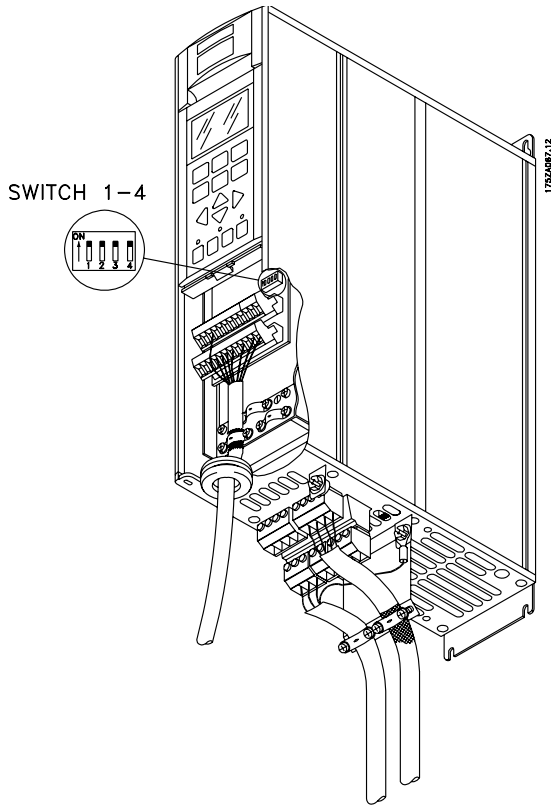

Bookstyle
VLT 5001-5006 200-240 V
VLT 5001-5011 380-500 V

Compact IP 20/Nema 1

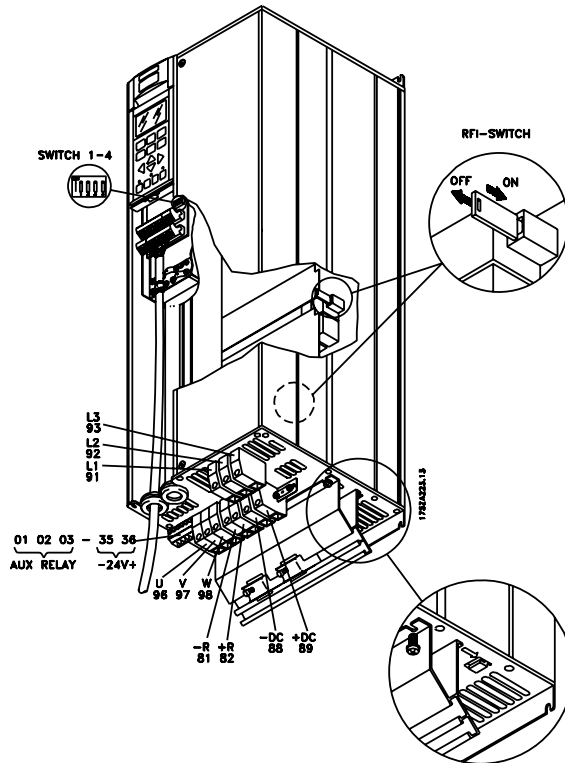
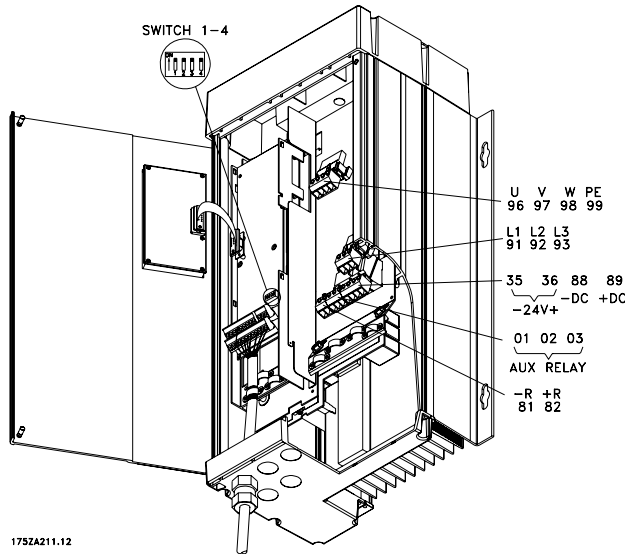

Compact IP 54
VLT 5001-5006 200-240 V
VLT 5001-5011 380-500 V
VLT 5001-5011 525-600 V

Compact IP 20/Nema 1
VLT 5008-5027 200-240 V
VLT 5016-5062 380-500 V
VLT 5016-5062 525-600 V

VLT® 5000 Series

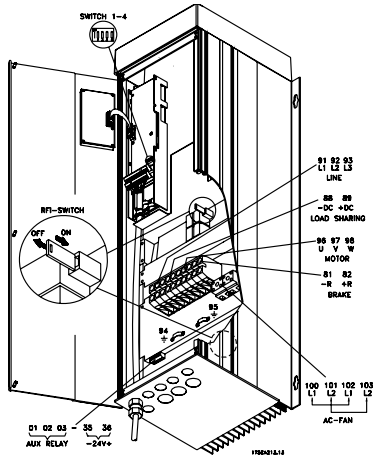

Compact IP 54
VLT 5008-5027 200-240 V
VLT 5016-5062 380-500 V

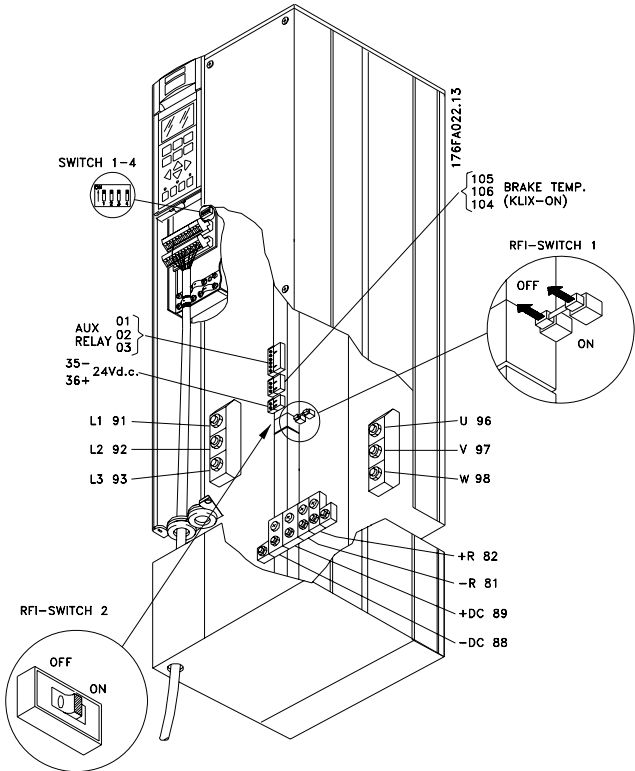

Compact IP 00/NEMA 1 (IP 20)
VLT 5032-5052 200-240 V

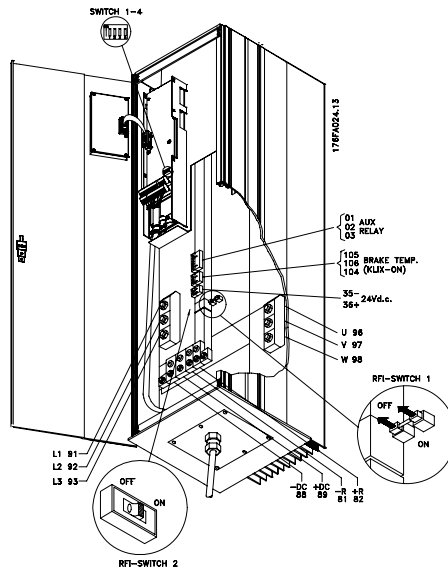
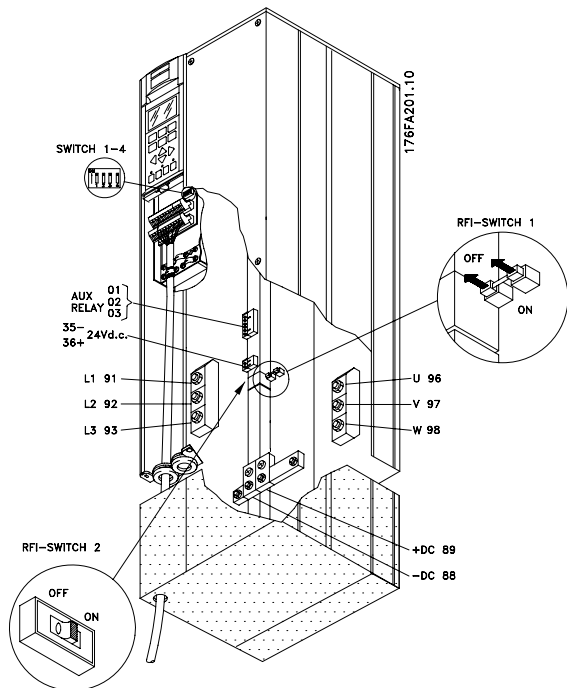

Compact IP 54
VLT 5032-5052 200-240 V

VLT® 5000 Series

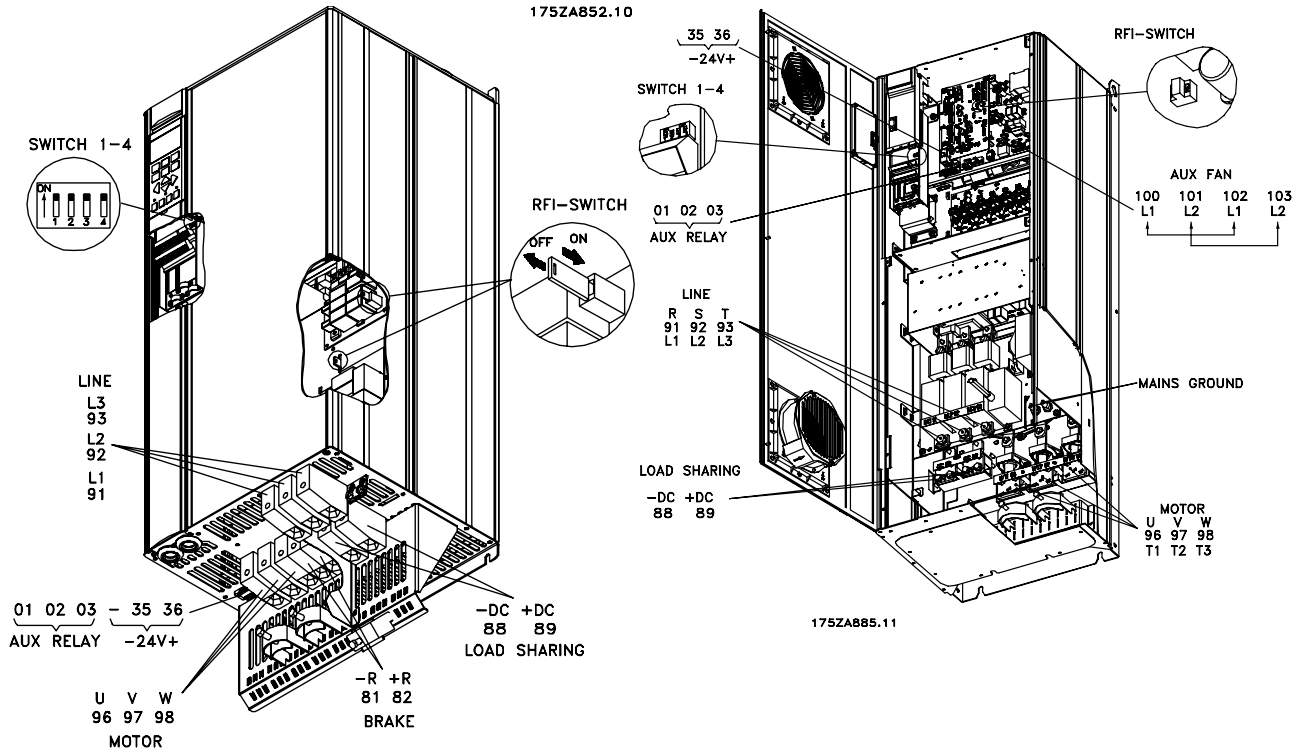

Compact IP 20
VLT 5072-5102 380-500 V

Compact IP 21/IP 54 with disconnect and fuse
VLT 5122-5152 380-500 V, VLT 5042-5152 525-690 V
NOTE: The RFI switch has no function in the 525-690 V drives

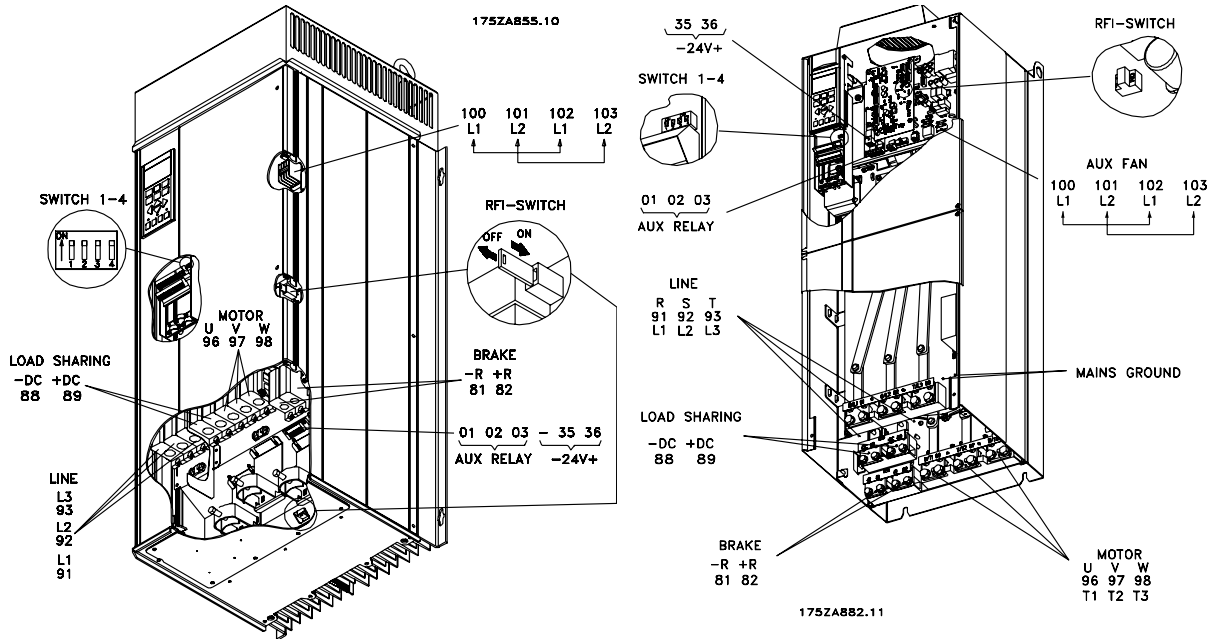

Compact IP 54
VLT 5072-5102 380-500 V

Compact IP 00 without disconnect and fuse
VLT 5122-5152 380-500 V, VLT 5042-5152 525-690 V

VLT® 5000 Series

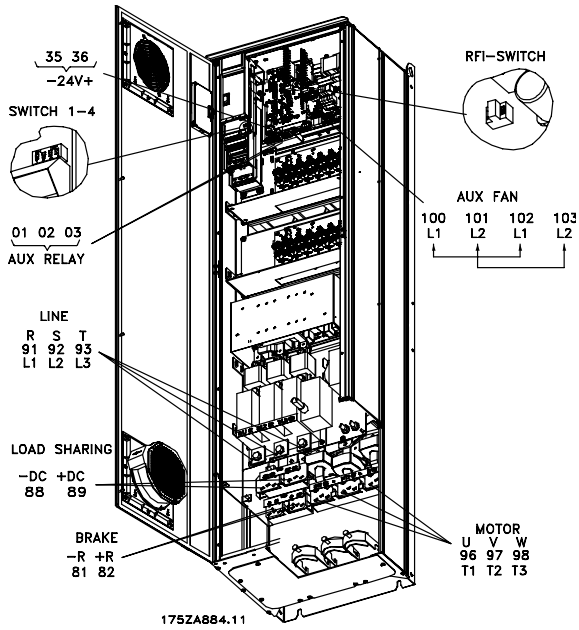

Compact IP 21/IP 54 with disconnect and fuse
VLT 5202-5302 380-500 V, VLT 5202-5352 525-690 V
 Note: The RFI switch has no function in the 525-690 V drives

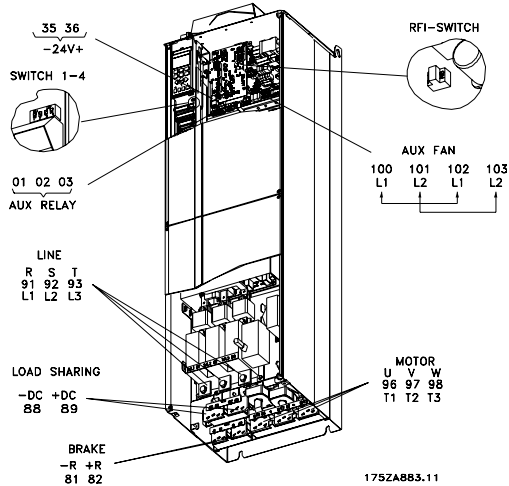

Compact IP 00 with disconnect and fuse
VLT 5202-5302 380-500 V, VLT 5202-5352 525-690 V

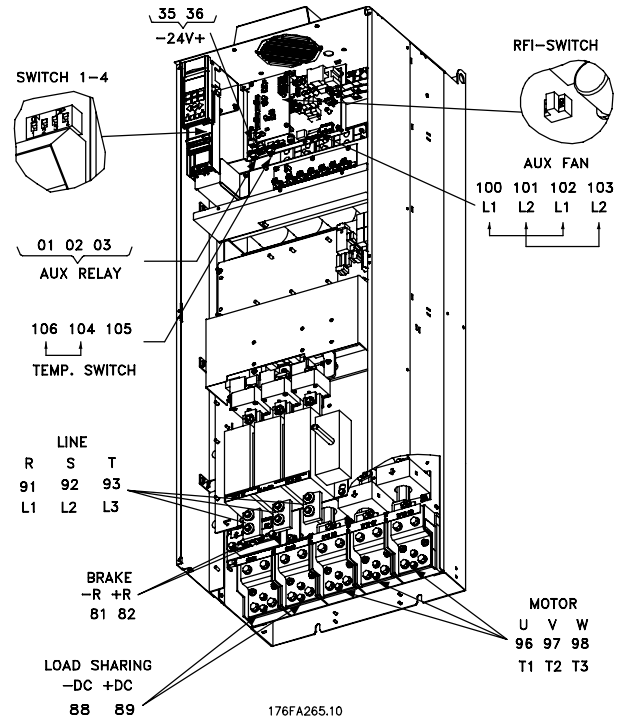

Compact IP 00 with disconnect and fuse
VLT 5352-5552 380-500 V, VLT 5402-5602 525-690 V

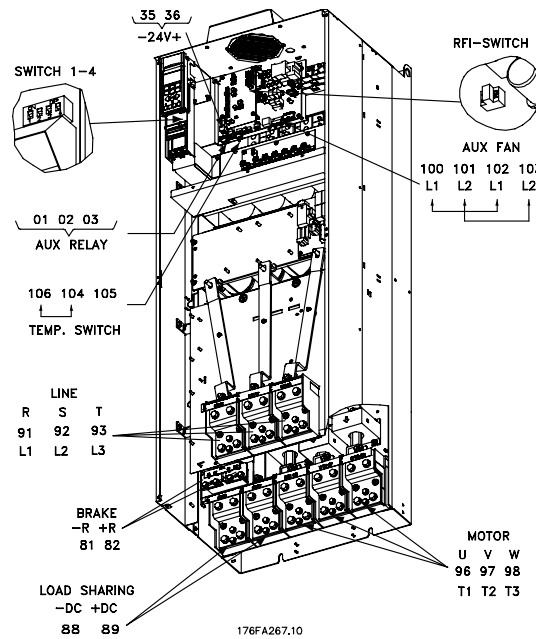

Compact IP 00 without disconnect and fuse
VLT 5352-5552 380-500 V, VLT 5402-5602 525-690 V
 Note: The RFI switch has no function in the 525-690 V drives

VLT® 5000 Series

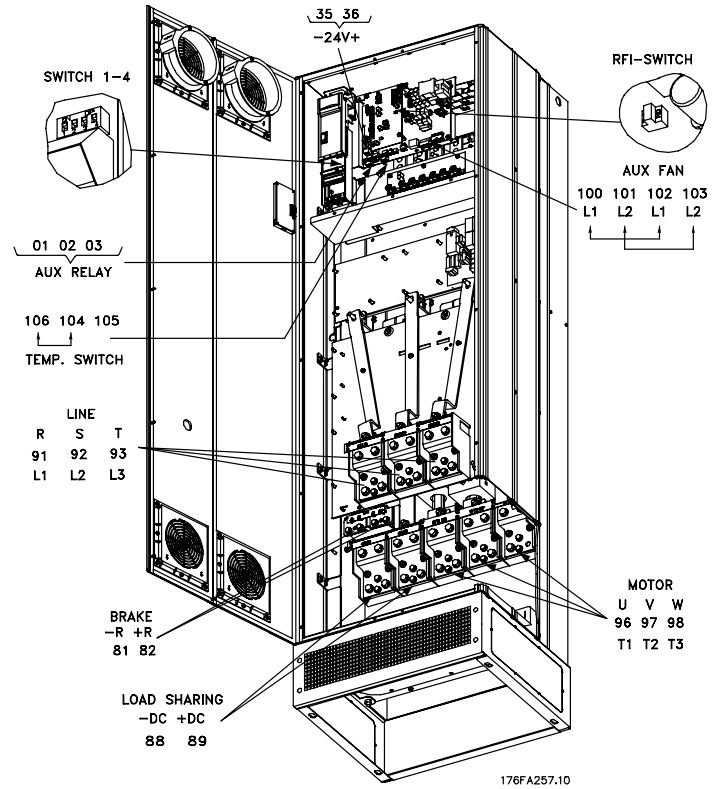

**Compact IP 21/IP 54 without disconnect and fuse
VLT 5352-5552 380-500 V, VLT 5402-5602, 525-690 V**
Note: The RFI switch has no function in the 525-690 V drives.

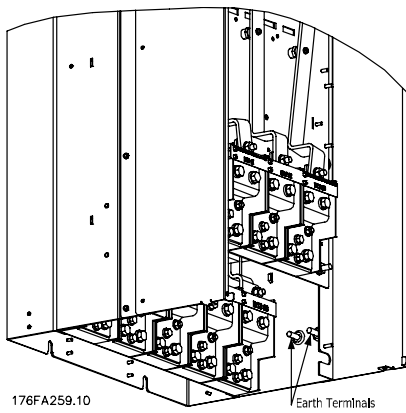

Position of earth terminals, IP 00

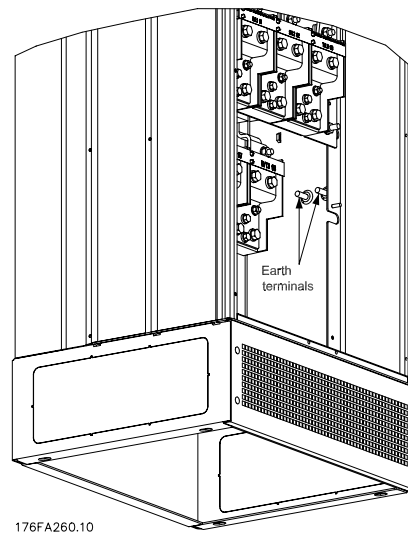

Position of earth terminals, IP 21/ IP 54

■ Electrical installation, power cables

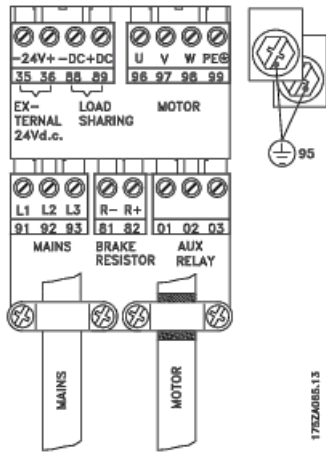

Bookstyle
VLT 5001-5006 200-240 V
VLT 5001-5011 380-500 V

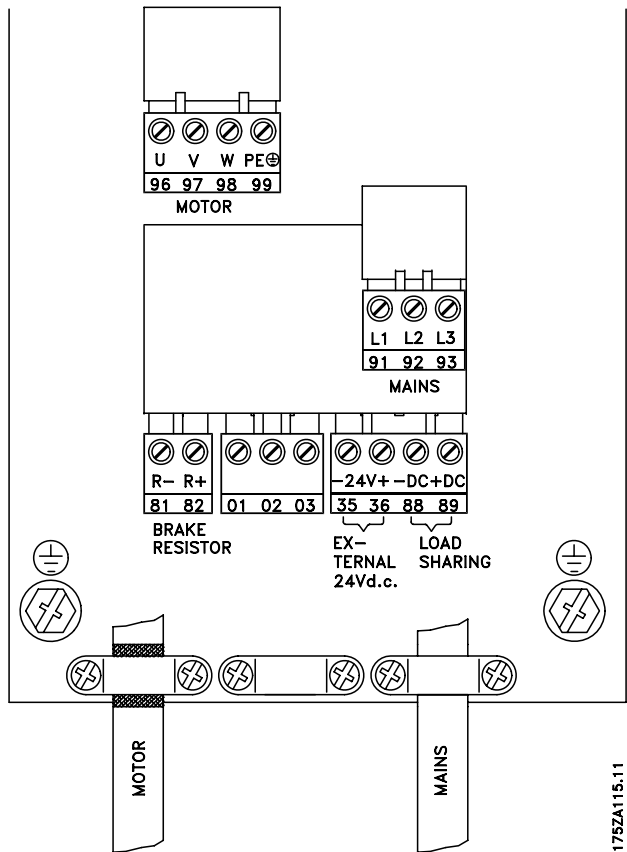

Compact IP 54
VLT 5001-5006 200-240 V
VLT 5001-5011 380-500 V
VLT 5001-5011 525-600 V

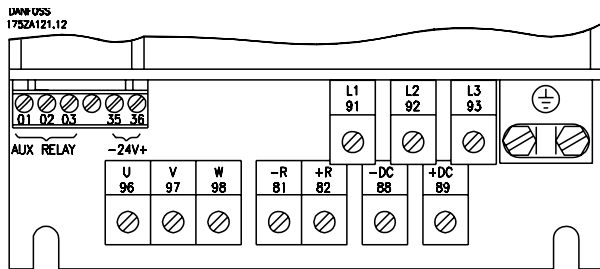

Compact IP 00/NEMA 1
VLT 5008-5027 200-240 V
VLT 5016-5102 380-500 V
VLT 5016-5062 525-600 V

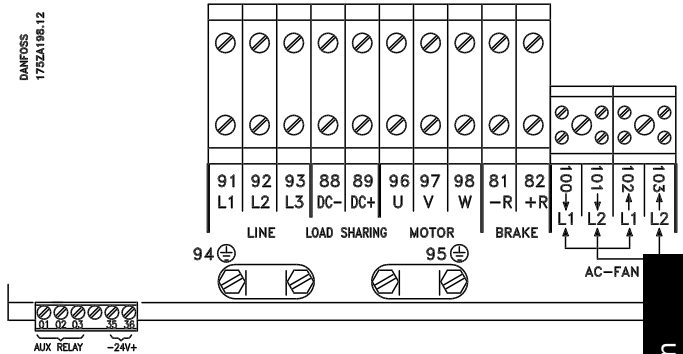

Compact IP 54
VLT 5008-5027 200-240 V
VLT 5016-5062 380-500 V

Installation

VLT® 5000 Series

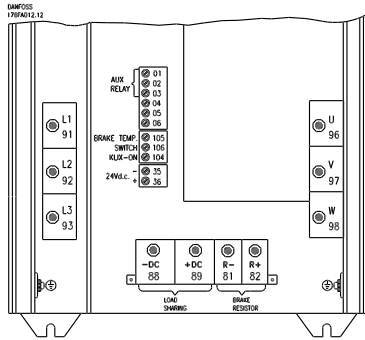

Compact IP 00/NEMA 1 (IP20)
VLT 5032-5052 200-240 V

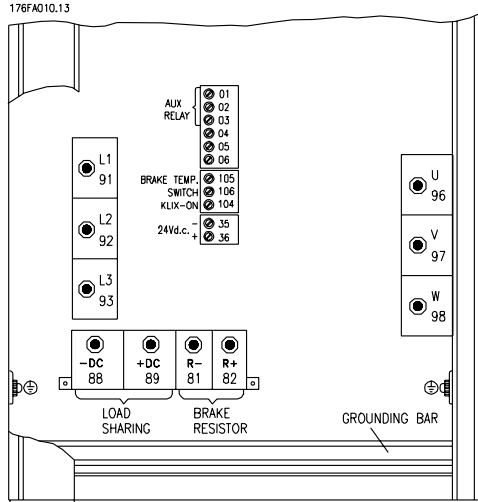

Compact IP 54
VLT 5032-5052 200-240 V

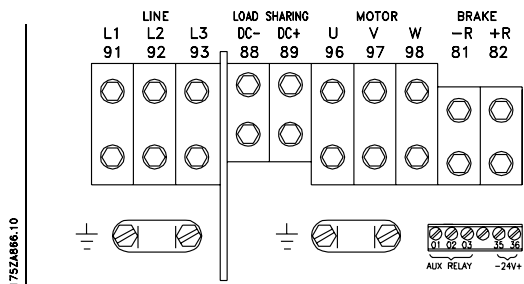

Compact IP 54
VLT 5072-5102 380-500 V

■ Electrical installation - control cables

All terminals for the control cables are located under the protective cover of the frequency converter. The protective cover (see drawing) can be removed by means of a pointed object - a screwdriver or similar.

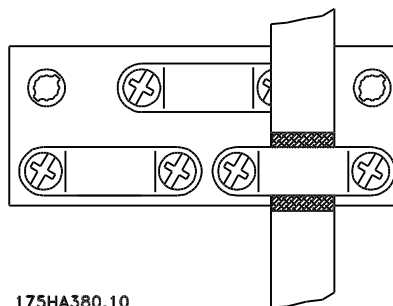
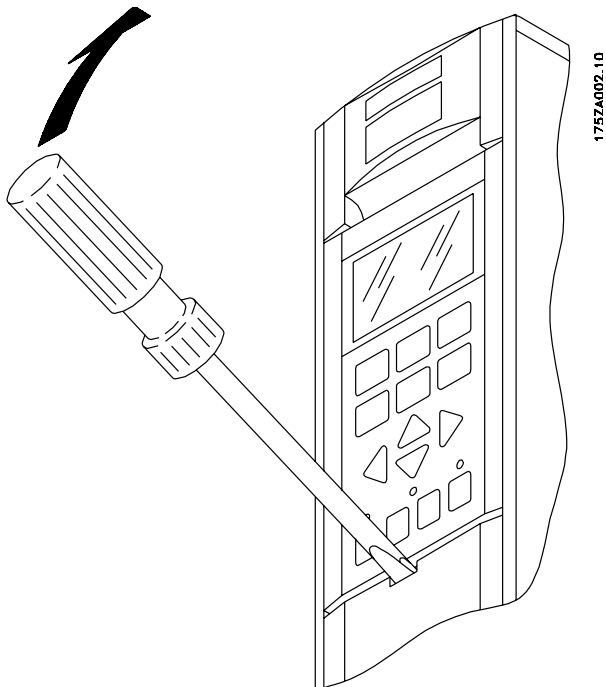

Once the protective cover has been removed, the actual EMC-correct installation can start. See drawings in the section, *EMC correct installation*.

Tightening-up torque: 0.5-0.6 Nm

Screw size: M3

See section *earthing of braided screened/armoured control cables*.

⊘	⊘	⊘	⊘	⊘	⊘	⊘	⊘	⊘	⊘	⊘	⊘	⊘	⊘	⊘	⊘	⊘
16	17	18	19	20	27	29	32	33						61	68	69
□	□	□	□	□	□	□	□	□	□	□	□	□	□	□	□	□
D IN	D IN	D IN	D IN	COM D IN	D IN	D IN	D IN	D IN	D IN	D IN	D IN	D IN	D IN	COM RS485	P RS485	N RS485

⊘	⊘	⊘	⊘	⊘	⊘	⊘	⊘	⊘	⊘	⊘	⊘	⊘
04	05	12	13	39	42	45	50	53	54	55	60	
□	□	□	□	□	□	□	□	□	□	□	□	□
RELAY		+24V OUT		COM A OUT	A OUT	A OUT	+10V OUT	A IN	A IN	COM A IN	A IN	A IN

175HA378.10

No.	Function
12, 13	Voltage supply to digital inputs For the 24 V DC to be usable for the digital inputs, switch 4 on the control card must be closed. position "ON".
16-33	Digital inputs/encoder inputs
20	Ground for digital inputs
39	Ground for analogue/digital outputs
42, 45	Analogue/digital outputs for indicating frequency, reference, current and torque
50	Supply voltage to potentiometer and thermistor 10 V DC
53, 54	Analogue reference input, voltage 0 - ± 10 V
55	Ground for analogue reference inputs
60	Analogue reference input, current 0/4-20 mA
61	Termination for serial communication. See section <i>Bus connection</i> . This terminal is normally not to be used.
68, 69	RS 485 interface, serial communication. Where the frequency converter is connected to a bus, switches 2 and 3 (switches 1- 4) must be closed on the first and the last frequency converter. On the remaining frequency converters, switches 2 and 3 must be open. The factory setting is closed (position "ON").

■ Electrical installation

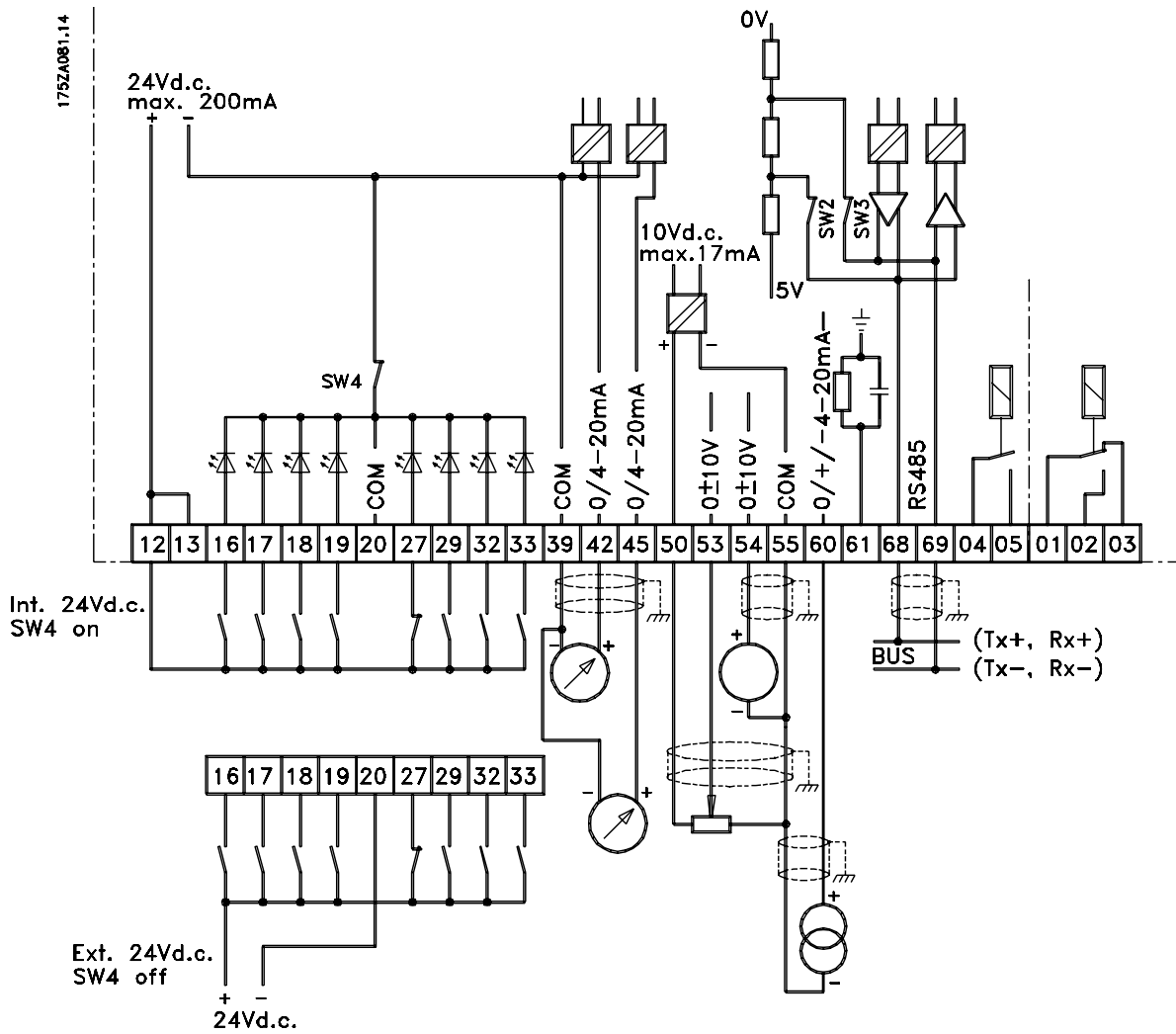

Conversion of analogue inputs

Current input signal to voltage input

0-20 mA • 0-10 V

4-20 mA • 2-10 V

Connect 510 ohms resistor between input terminal 53 and 55 and adjust minimum and maximum values in parameters 309, and 310 or 54 and 55 and adjust minimum and maximum values in parameters 312 and 313.

■ **Electrical installation - bus connection**

The serial bus connection in accordance with the RS 485 (2-conductor) norm is connected to terminals 68/69 of the frequency converter (signals P and N). Signal P is the positive potential (TX+,RX+), while signal N is the negative potential (TX-,RX-).

If more than one frequency converter is to be connected to a given master, use parallel connections.

175ZA079.11

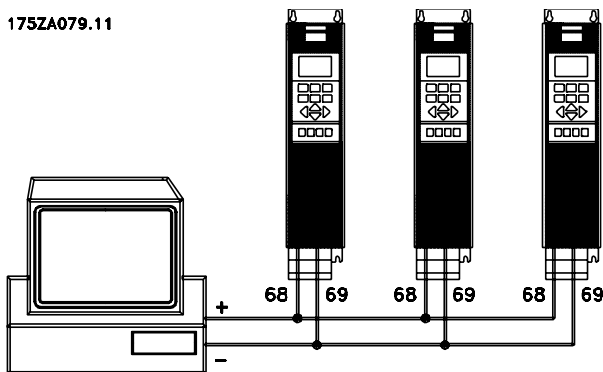

In order to avoid potential equalizing currents in the screen, the cable screen can be earthed via terminal 61, which is connected to the frame via an RC-link.

Bus termination

The bus must be terminated by a resistor network at both ends. For this purpose, set switches 2 and 3 on the control card for "ON".

■ **DIP Switches 1-4**

The dipswitch is located on the control card. It is used for serial communication, terminals 68 and 69. The switching position shown is the factory setting.



Switch 1 has no function. Switches 2 and 3 are used for terminating an RS 485 interface, serial communication. Switch 4 is used for separating the common potential for the internal 24 V DC supply from the common potential of the external 24 V DC supply.



NB! Please note that when Switch 4 is in position "OFF", the external 24 V DC supply is galvanically isolated from the frequency converter.

■ Electrical installation - EMC precautions

The following is a guideline to good engineering practice, when installing drives. Following these guidelines is advised, where compliance with EN 61000-6-3, EN 61000-6-4, EN 55011 or EN 61800-3 *First environment* is required. If the installation is in EN 61800-3 *Second environment*, i.e. industrial networks or in an installation that has its own transformer, it is acceptable to deviate from these guidelines. It is however not recommended. See also *CE labelling, Emission and EMC test results* under special conditions in the Design Guide for further details.

Good engineering practice to ensure EMC-correct electrical installation:

- Use only braided screened/armoured motor cables and braided screened/armoured control cables. The screen should provide a minimum coverage of 80%. The screen material must be metal, not limited to but typically copper, aluminium, steel or lead. There are no special requirements for the mains cable.
- Installations using rigid metal conduits are not required to use screened cable, but the motor cable must be installed in conduit separate from the control and mains cables. Full connection of the conduit from the drive to the motor is required. The EMC performance of flexible conduits varies a lot and information from the manufacturer must be obtained.
- Connect the screen/armour/conduit to earth at both ends for motor cables as well as for control cables. In some cases, it is not possible to connect the screen in both ends. In these cases, it is important to connect the screen at the frequency converter. See also *Earthing of braided screened/armoured control cables*.
- Avoid terminating the screen/armour with twisted ends (pigtails). Such a termination increases the high frequency impedance of the

screen, which reduces its effectiveness at high frequencies. Use low impedance cable clamps or EMC cable glands instead.

- It is important to ensure good electrical contact between the mounting plate on which the frequency converter is installed and the metal chassis of the frequency converter. However, this does not apply to IP 54 units as they are designed for wall-mounting and VLT 5122-5552 380-500 V, 5042-5602 525-690 V and VLT 5032-5052 200-240 V in IP20/NEMA 1 enclosure and IP 54/NEMA 12 enclosure.
- Use starwashers and galvanically conductive installation plates to secure good electrical connections for IP00 and IP20 installations.
- Avoid using unscreened/unarmoured motor or control cables inside cabinets housing the drive(s), whenever this can be avoided.
- An uninterrupted high frequency connection between the frequency converter and the motor units is required for IP54 units.

The illustration shows an example of an EMC-correct electrical installation of an IP 20 frequency converter; the frequency converter has been fitted in an installation cabinet with an output contactor and connected to a PLC, which in this example is installed in a separate cabinet. In IP 54 units and VLT 5032-5052, 200-240 V in IP20/IP21/NEMA 1 enclosure screened cables are connected by using EMC conduits to ensure proper EMC performance. See illustration. Other ways of making the installation may have as good an EMC performance, provided the above guide lines to engineering practice are followed.

Please note, that when the installation is not carried through according to the guideline as well as when unscreened cables and control wires are used, some emission requirements are not complied with, although the immunity requirements are fulfilled. See the section *EMC test results* in the Design Guide for further details.

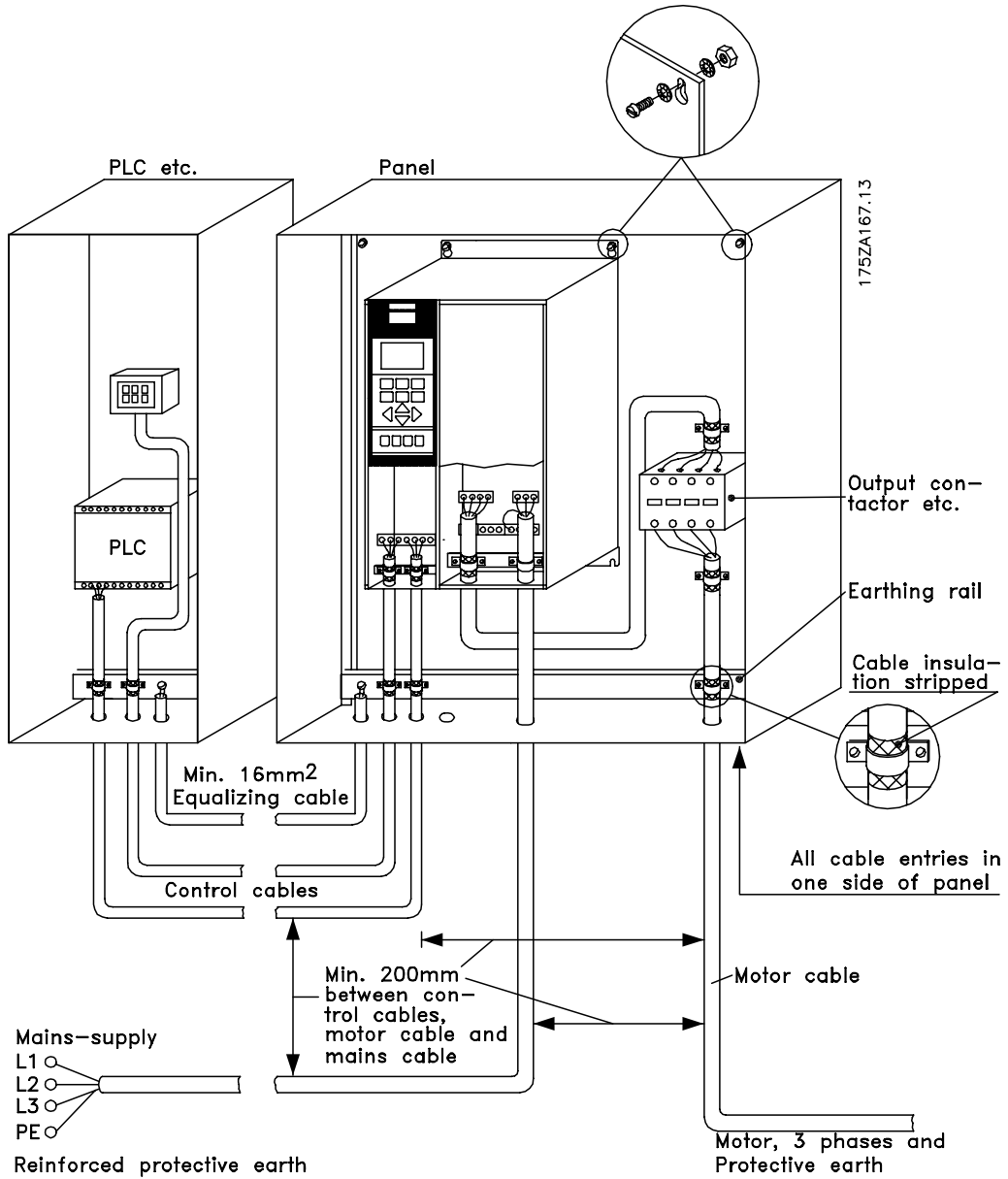

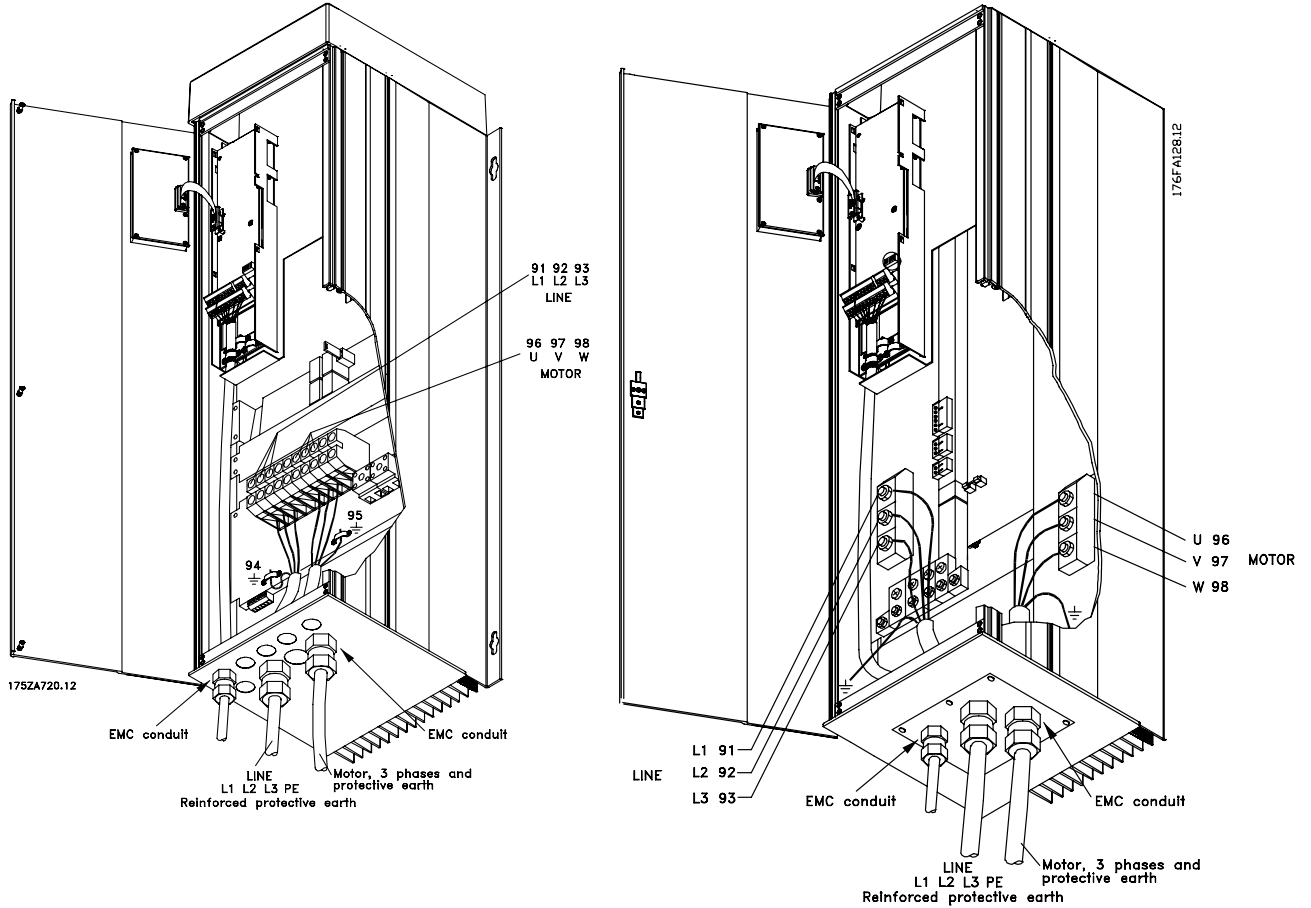

■ Use of emc-correct cables

Braided screened/armoured cables are recommended to optimise EMC immunity of the control cables and the EMC emission from the motor cables.

The ability of a cable to reduce the in- and outgoing radiation of electric noise depends on the transfer impedance (Z_T). The screen of a cable is normally designed to reduce the transfer of electric noise; however, a screen with a lower transfer impedance (Z_T) value is more effective than a screen with a higher transfer impedance (Z_T).

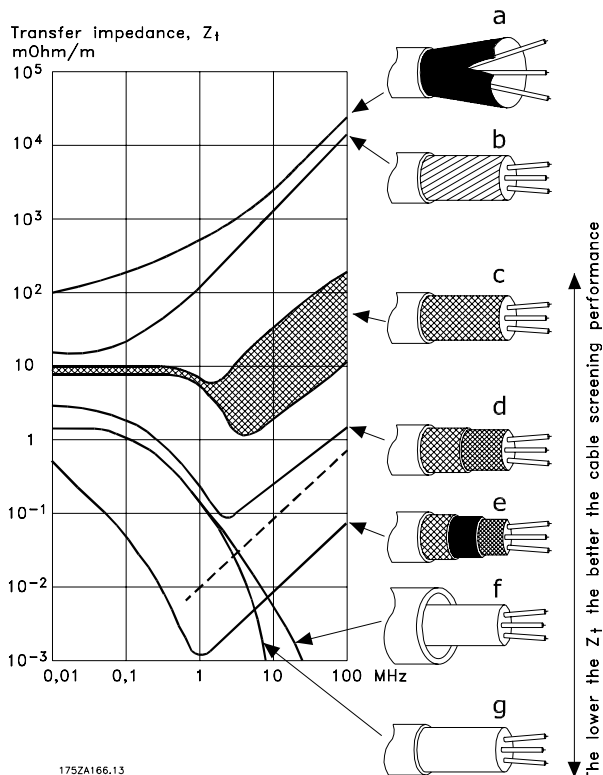

Transfer impedance (Z_T) is rarely stated by cable manufacturers, but it is often possible to estimate transfer impedance (Z_T) by assessing the physical design of the cable.

Transfer impedance (Z_T) can be assessed on the basis of the following factors:

- The conductivity of the screen material.
- The contact resistance between the individual screen conductors.
- The screen coverage, i.e. the physical area of the cable covered by the screen - often stated as a percentage value.
- Screen type, i.e. braided or twisted pattern.

Aluminium-clad with copper wire.

Twisted copper wire or armoured steel wire cable.

Single-layer braided copper wire with varying percentage screen coverage.
This is the typical Danfoss reference cable.

Double-layer braided copper wire.

Twin layer of braided copper wire with a magnetic, screened/ armoured intermediate layer.

Cable that runs in copper tube or steel tube.

Lead cable with 1.1 mm wall thickness.

■ Electrical installation - earthing of control cables

Generally speaking, control cables must be braided screened/armoured and the screen must be connected by means of a cable clamp at both ends to the metal cabinet of the unit.

The drawing below indicates how correct earthing is carried out and what to be done if in doubt.

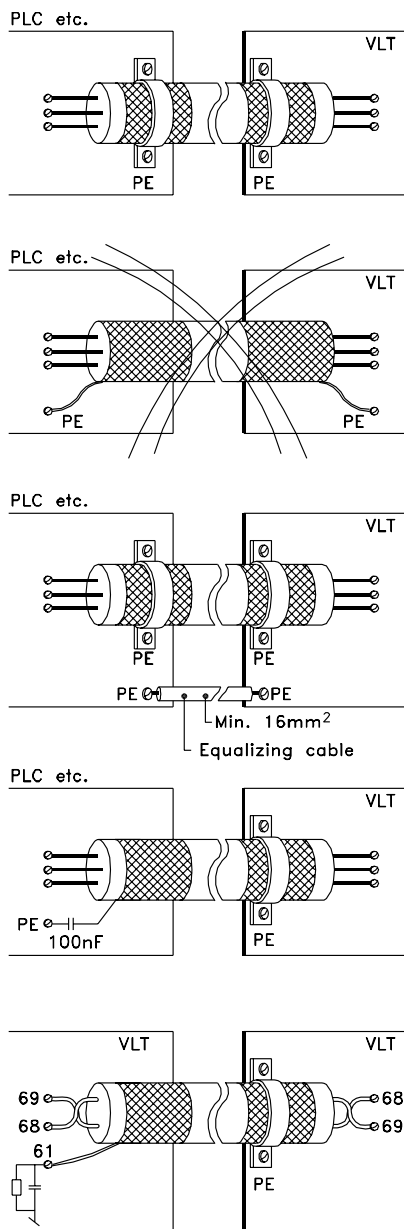

175ZA165.11

Correct earthing

Control cables and cables for serial communication must be fitted with cable clamps at both ends to ensure the best possible electrical contact

Wrong earthing

Do not use twisted cable ends (pigtailed), since these increase the screen impedance at high frequencies.

Protection with respect to earth potential between PLC and VLT

If the earth potential between the frequency converter and the PLC (etc.) is different, electric noise may occur that will disturb the whole system. This problem can be solved by fitting an equalising cable, to be placed next to the control cable. Minimum cable cross-section: 16 mm².

For 50/60 Hz earth loops

If very long control cables are used, 50/60 Hz earth loops may occur. This problem can be solved by connecting one end of the screen to earth via a 100nF capacitor (keeping leads short).

Cables for serial communication

Low-frequency noise currents between two frequency converters can be eliminated by connecting one end of the screen to terminal 61. This terminal is connected to earth via an internal RC link. It is recommended to use twisted-pair cables to reduce the differential mode interference between the conductors.

■ RFI switch

Mains supply isolated from earth:

If the frequency converter is supplied from an isolated mains source (IT mains) or TT/TN-S mains with grounded leg, the RFI switch is recommended to be turned off (OFF)¹⁾. For further reference, see IEC 364-3. In case optimum EMC performance is needed, parallel motors are connected or the motor cable length is above 25 m, it is recommended to set the switch in ON position.

In OFF position, the internal RFI capacities (filter capacitors) between the chassis and the intermediate circuit are cut off to avoid damage to the intermediate circuit and to reduce the earth capacity currents (according to IEC 61800-3).

Please also refer to the application note *VLT on IT mains*, MN.90.CX.02. It is important to use isolation monitors that are capable for use together with power electronics (IEC 61557-8).



NB!

The RFI switch is not to be operated with mains connected to the unit. Check that the mains supply has been disconnected before operating the RFI switch.



NB!

Open RFI switch is only allowed at factory set switching frequencies.



NB!

The RFI switch connects the capacitors galvanically to earth.

The red switches are operated by means of e.g. a screwdriver. They are set in the OFF position when they are pulled out and in ON position when they are pushed in. Factory setting is ON.

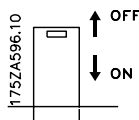

Mains supply connected to earth:

The RFI switch must be in ON position in order for the frequency converter to comply with the EMC standard.

1) Not possible with 5042-5602, 525-690 V units.

Position of RFI switches

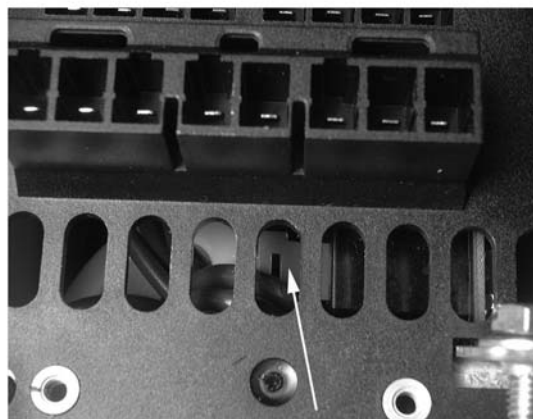

175ZA649.10

Bookstyle IP 20

VLT 5001 - 5006 200 - 240 V

VLT 5001 - 5011 380 - 500 V

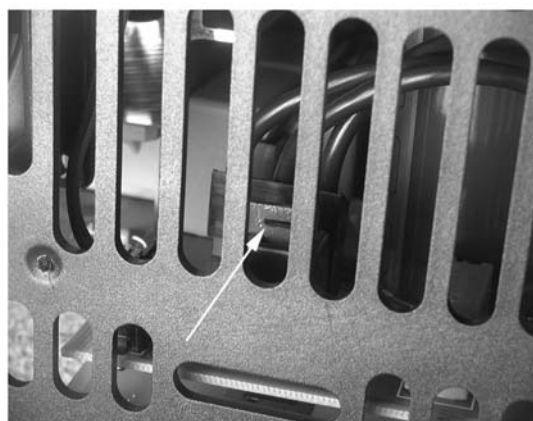

175ZA650.10

Compact IP 20/NEMA 1

VLT 5001 - 5006 200 - 240 V

VLT 5001 - 5011 380 - 500 V

VLT 5001 - 5011 525 - 600 V

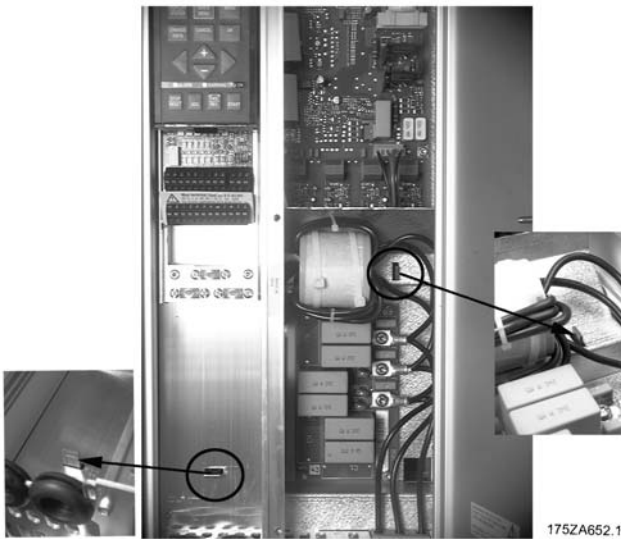

175ZA652.10



175ZA648.10

Compact IP 20/NEMA 1
VLT 5008 200 - 240 V
VLT 5016 - 5022 380 - 500 V
VLT 5016 - 5022 525 - 600 V

Compact IP 20/NEMA 1
VLT 5022 - 5027 200 - 240 V
VLT 5042 - 5102 380 - 500 V
VLT 5042 - 5062 525 - 600 V

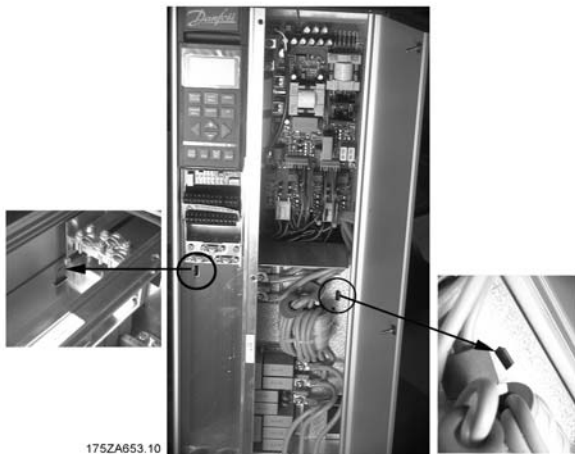

175ZA653.10

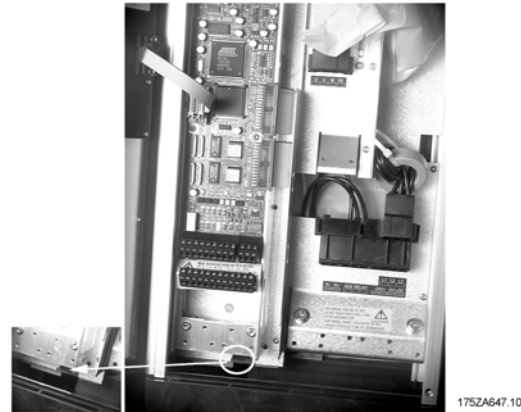

175ZA647.10

Compact IP 20/NEMA 1
VLT 5011 - 5016 200 - 240 V
VLT 5027 - 5032 380 - 500 V
VLT 5027 - 5032 525 - 600 V

Compact IP 54
VLT 5001 - 5006 200 - 240 V
VLT 5001 - 5011 380 - 500 V



Compact IP 54
VLT 5008 - 5011 200 - 240 V
VLT 5016 - 5027 380 - 500 V

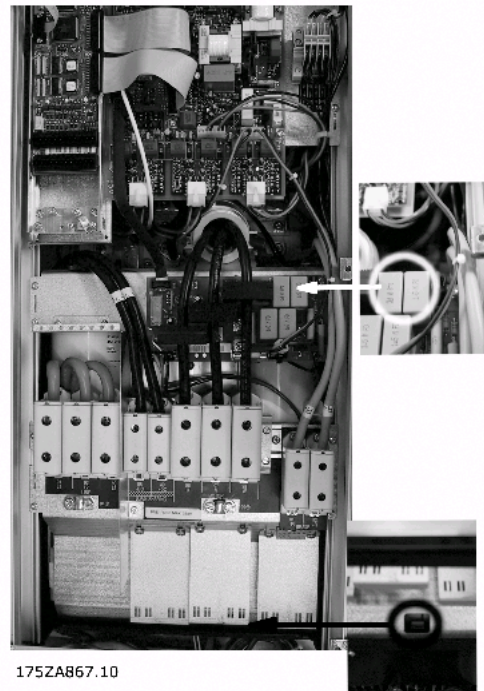

Compact IP 54
VLT 5072 - 5102 380 - 500 V

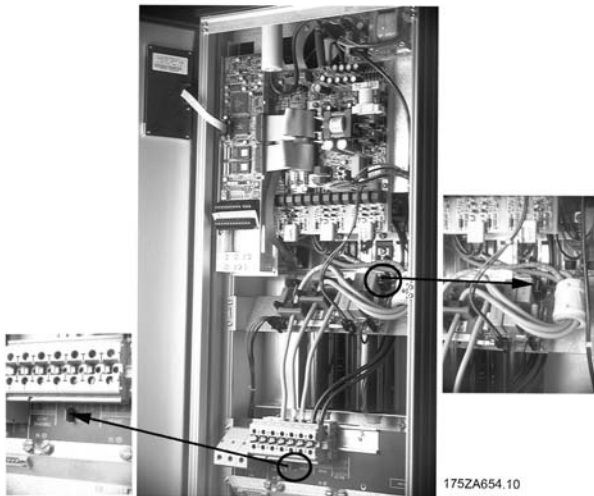

Compact IP 54
VLT 5016 - 5027 200 - 240 V
VLT 5032 - 5062 380 - 500 V

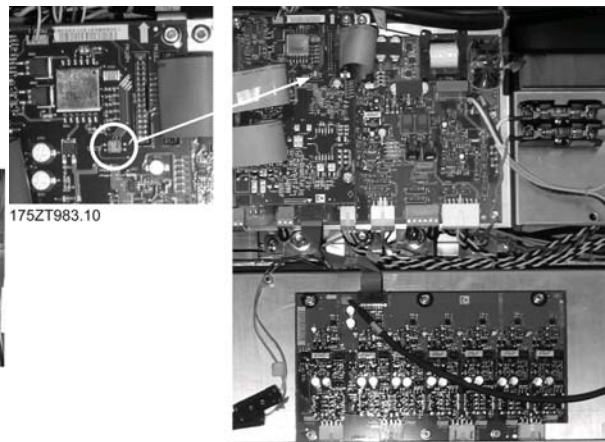

All enclosure types
VLT 5122-5552 380 - 500 V

■ Control panel (LCP)

The front of the frequency converter features a control panel - LCP (Local Control Panel), which makes up a complete interface for operation and monitoring of the VLT 5000 Series.

The control panel is detachable and can - as an alternative - be installed up to 3 metres away from the frequency converter, e.g. on a front panel, by means of a mounting kit option.

The functions of the control panel can be divided into three groups:

- display
- keys for changing program parameters
- keys for local operation

All data are indicated by means of a 4-line alpha-numeric display, which in normal operation is able to show 4 measurements and 3 operating conditions continuously. During programming, all the information required for quick, effective parameter Setup of the frequency converter will be displayed. As a supplement to the display, there are three LEDs for voltage (power or 24 V external), warning and alarm.

All program parameters of the frequency converter can be changed immediately from the control panel, unless this function has been blocked via parameter 018.

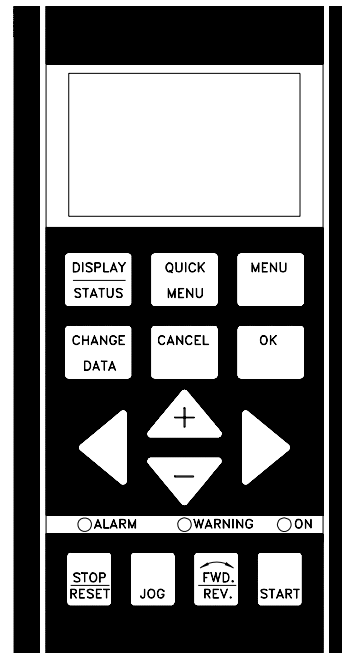

DANFOSS
175ZA004.10

■ Control panel - display

The LCD-display has rear lighting and a total of 4 alpha-numeric lines together with a box that shows the direction of rotation (arrow) and the chosen Setup as well as the Setup in which programming is taking place if that is the case.

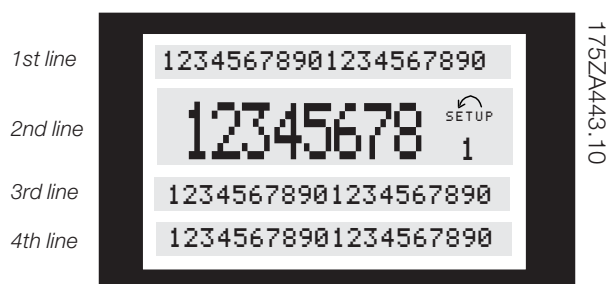

1st line shows up to 3 measurements continuously in normal operating status or a text which explains the 2nd line.

2nd line shows a measurement with related unit continuously, regardless of status (except in the case of alarm/warning).

3rd line is normally blank and is used in the menu mode to show the selected parameter number or parameter group number and name.

4th line is used in operating status for showing a status text or in data change mode for showing the mode or value of the selected parameter.

An arrow indicates the direction of rotation of the motor. Furthermore, the Setup which has been selected as the Active Setup in parameter 004 is shown. When programming another Setup than the Active Setup, the number of the Setup which is being programmed will appear to the right. This second Setup number will flash.

■ Control panel - LEDs

At the bottom of the control panel is a red alarm LED and a yellow warning LED, as well as a green voltage LED.

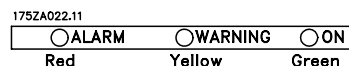

If certain threshold values are exceeded, the alarm and/or warning LED lights up together with a status and alarm text on the control panel.

The voltage LED is activated when the frequency converter receives voltage, or 24 V external supply; at the same time the rear lighting of the display will be on.

■ Control panel - control keys

The control keys are divided into functions. This means that the keys between display and indicator lamps are used for parameter Setup, including choice of display indication during normal operation.

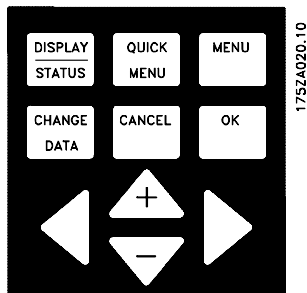

Keys for local control are found under the indicator LEDs.



■ Control key functions



[DISPLAY / STATUS] is used for selecting the mode of display or for changing back to Display mode from either the Quick menu mode or the Menu mode.



[QUICK MENU] is used for programming the parameters that belong under the Quick menu mode. It is possible to switch directly between Quick menu mode and Menu mode.



[MENU] is used for programming all parameters. It is possible to switch directly between Menu mode and Quick menu mode.



[CHANGE DATA] is used for changing the parameter selected either in the Menu mode or the Quick menu mode.



[CANCEL] is used if a change of the selected parameter is not to be carried out.



[OK] is used for confirming a change of the parameter selected.



[+/-] is used for selecting parameter and for changing the chosen parameter or for changing the read out in line 2.



[<>] is used for selecting group and to move the cursor when changing numerical parameters.



[STOP / RESET] is used for stopping the motor connected or for resetting the frequency converter after a drop-out (trip). Can be selected via parameter 014 to be active or inactive. If stop is activated, line 2 will flash, and [START] must be activated.



[JOG] overrides the output frequency to a preset frequency while the key is kept down. Can be selected via parameter 015 to be active or inactive.



[FWD / REV] changes the direction of rotation of the motor, which is indicated by means of the arrow on the display although only in Local. Can be selected via parameter 016 to be active or inactive.



[START] is used for starting the frequency converter after stop via the "Stop" key. Is always active, but cannot override a stop command given via the terminal strip.



NB!

If the keys for local control have been selected as active, they will remain active both when the frequency has been set for *Local Control* and for *Remote Control* via parameter 002, although with the exception of [Fwd/rev], which is only active in Local operation.



NB!

If no external stop function has been selected and the [Stop] key has been selected as inactive, the motor can be started and can only be stopped by disconnecting the voltage to the motor.

■ Control panel - display read-outs

The display read-out state can be varied - see the list below - depending on whether the frequency converter is in normal operation or is being programmed.

■ Display mode

In normal operation, up to 4 different operating variables can be indicated continuously: 1.1 and 1.2 and 1.3 and 2, and in line 4 the present operating status or alarms and warnings that have arisen.



■ Display mode - selection of read-outstate

There are three options in connection with the choice of read-out state in the Display mode - I, II and III. The choice of read-out state determines the number of operating variables read out.

Read-out state:	I:	II:	III:
Line 1	Description for operating variable in line 2	Data value for 3 operating variables in line 1	Description for 3 operating variables in line 1

The table below gives the units linked to the variables in the first and second line of the display.

Operating variable:	Unit:
Reference	[%]
Reference	[unit]
Feedback	[unit]
Frequency	[Hz]
Frequency x scaling	[-]
Motor current	[A]
Torque	[%]
Power	[kW]
Power	[HP]
Output energy	[kWh]
Motor voltage	[V]
DC-link voltage	[V]
Motor thermal load	[%]
VLT thermal load	[%]
Hours run	[Hours]
Input status, dig. Input	[Binary code]
Input status, analogue terminal 53	[V]
Input status, analogue terminal 54	[V]
Input status, analogue terminal 60	[mA]
Pulse reference	[Hz]
External reference	[%]
Status word	[Hex]
Brake effect/2 min.	[kW]
Brake effect/sec.	[kW]
Heat sink temp.	[C]
Alarm word	[Hex]
Control word	[Hex]
Warning word 1	[Hex]
Extended status word	[Hex]
Communication option card warning	[Hex]
RPM	[min ⁻¹]
RPM x scaling	[-]
LCP Display text	[-]

Operating variables 1.1 and 1.2 and 1.3 in the first line, and operating variable 2 in the second line are selected via parameter 009, 010, 011 and 012.

- Read-out state I:

This read-out state is standard after starting up or after initialisation.

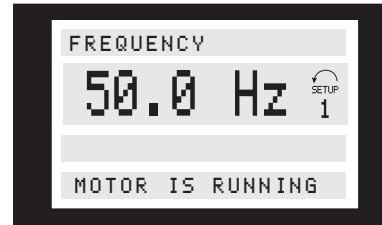

Line 2 gives the data value of an operating variable with related unit, and line 1 provides a text which explains line 2, cf. table. In the example, Frequency has been selected as variable via parameter 009. During normal operation another variable can immediately be read out by using the [+/-] keys.

- Read-out state II:

Switching between read-out states I and II is effected by pressing the [DISPLAY / STATUS] key.

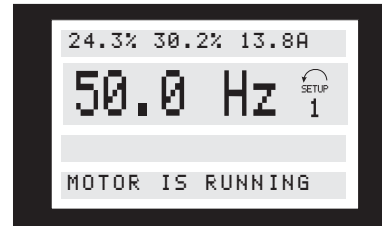

In this state, data values for four operating values are shown at the same time, giving the related unit, cf. table. In the example, Reference, Torque, Current and Frequency are selected as variables in the first and second line.

- Read-out state III:

This read-out state can be held as long as the [DISPLAY/STATUS] key is pressed. When the key is released, the SYSTEM switches back to Read-out state II, unless the key is pressed for less than approx. 1 sec., in which case the SYSTEM always reverts to Read-out state I.

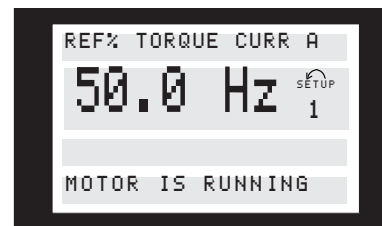

This is where parameter names and units for operating variables in the first and second line are given - operating variable 2 remains unchanged.

- Display state IV:

This display state can be produced during operation if another setup is to be changed without stopping the frequency converter. This function is activated in parameter 005, *Programming Setup*.

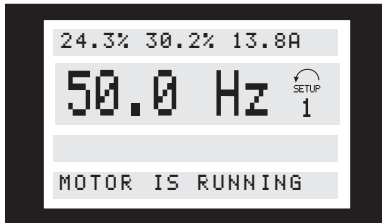

The selected programming setup number will flash to the right of the active setup.

■ Parameter Setup

The VLT 5000 Series can be used for practically all assignments, which is why the number of parameters is quite large. Also, this series offers a choice between two programming modes - a Menu mode and a Quick menu mode.

The former provides access to all parameters. The latter takes the user through a few parameters which make it possible in most cases to start operating the frequency converter.

Regardless of the mode of programming, a change of a parameter will take effect and be visible both in the Menu mode and in the Quick menu mode.

■ Structure for the Quick menu mode versus the Menu mode

In addition to having a name, each parameter is linked up with a number which is the same regardless of the programming mode. In the Menu mode, the parameters are divided into groups, with the first digit of the parameter number (from the left) indicating the group number of the parameter in question.

- The quick menu takes the user through a number of parameters that may be enough to get the motor to run nearly optimally, if the factory setting for the other parameters takes the desired control functions into account, as well as the configuration of signal inputs/outputs (control terminals).
- The Menu mode makes it possible to select and change all parameters at the user's option. However, some parameters will be "missing", depending on the choice of configuration (parameter 100), e.g. open loop hides all the P.I.D. parameters.

■ Quick Setup

The Quick Setup starts with pressing the [QUICK MENU] key, which brings out the following read-out on the display:



At the bottom of the display, the parameter number and name are given together with the status/value of the first parameter under Quick Setup. The first time the [Quick Menu] key is pressed after the unit has been switched on, the read-outs always start at pos. 1 - see table below.

■ Parameter selection

The selection of parameter is effected by means of the [+/-] keys. The following parameters are accessible:

Pos.:	No.:	Parameter:	Unit:
1	001	Language	
2	102	Motor output	[kW]
3	103	Motor voltage	[V]
4	104	Motor frequency	[Hz]
5	105	Motor current	[A]
6	106	Rated motor speed	[rpm]
7	107	Automatic motor adaptation, AMA	
8	204	Minimum reference	[Hz]
9	205	Maximum reference	[Hz]
10	207	Ramp-up time 1	[sec.]
11	208	Ramp-down time 1	[sec.]
12	002	Local/remote control	
13	003	Local reference	

■ Menu mode

The Menu mode is started by pressing the [MENU] key, which produces the following read-out on the display:

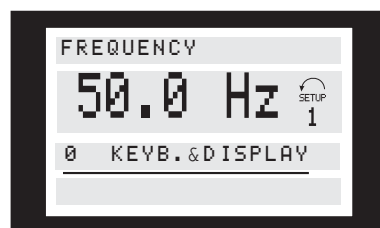

Line 3 on the display shows the parameter group number and name.

■ Parameter selection

In the Menu mode the parameters are divided into groups. Selection of parameter group is effected by means of the [$\leftarrow\right\rangle$] keys.

The following parameter groups are accessible:

Group no.	Parameter group:
0	Operation & Display
1	Load & Motor
2	References & Limits
3	Inputs & Outputs
4	Special functions
5	Serial communication
6	Technical functions
7	Application Options
8	Fieldbus Profile
9	Fieldbus Communication

When the desired parameter group has been selected, each parameter can be chosen by means of the [+/-] keys:

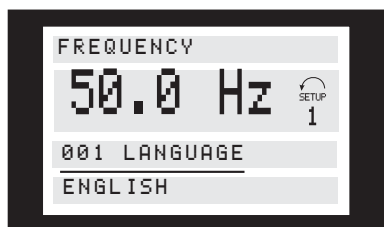

The 3rd line of the display shows the parameter number and name, while the status/value of the selected parameter are shown in line 4.

■ Changing data

Regardless of whether a parameter has been selected under the Quick menu or the Menu mode, the procedure for changing data is the same.

Pressing the [CHANGE DATA] key gives access to changing the selected parameter, following which the underlining in line 4 will flash on the display.

The procedure for changing data depends on whether the selected parameter represents a numerical data value or a text value.

■ Changing a text value

If the selected parameter is a text value, the text value is changed by means of the [+/-] keys.

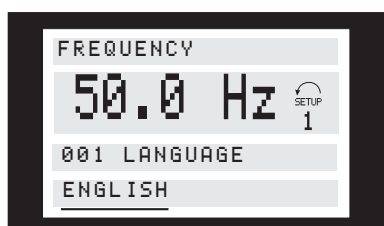

The bottom display line shows the text value that will be entered (saved) when acknowledgement is given [OK].

■ Change of group of numeric data values

If the chosen parameter represents a numeric data value, the chosen data value is changed by means of the [+/-] keys.

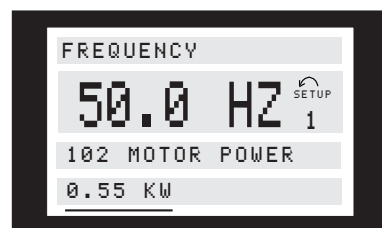
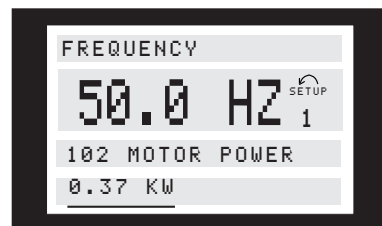

The chosen data value is indicated by the digit flashing.

The bottom display line shows the data value that will be entered (saved) when signing off with [OK].

■ Infinitely variable change of numeric data value

If the chosen parameter represents a numeric data value, a digit is first selected by means of the [$\leftarrow\right\rangle$] keys.

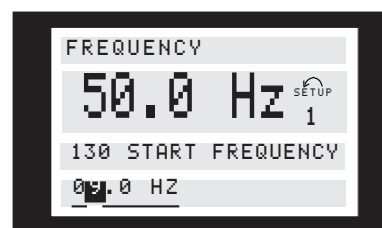

Then the chosen digit is changed infinitely variably by means of the [+/-] keys:

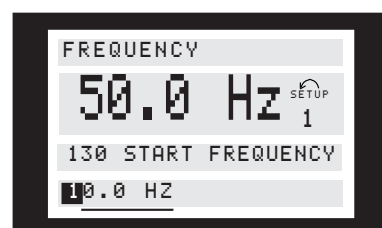

The chosen digit is indicated by the digit flashing. The bottom display line shows the data value that will be entered (saved) when signing off with [OK].

■ Changing of data value, step-by-step

Certain parameters can be changed step by step or infinitely variably. This applies to Motor power (parameter 102), Motor voltage (parameter 103) and Motor frequency (parameter 104).

The parameters are changed both as a group of numeric data values and as numeric data values infinitely variably.

■ Read out and programming of indexed parameters

Parameters are indexed when placed in a rolling stack. Parameter 615 - 617 contain a historical log which can be read out. Choose the actual parameter, press the [CHANGE DATA] key and use the [+] and [-] keys to scroll through the log of values. During the read out line 4 of the display will flash.

If a bus option is mounted in the drive, the programming of parameter 915 - 916 needs to be carried through in the following way:

Choose the actual parameter, press the [CHANGE DATA] key and use the [+] and [-] keys to scroll through the different indexed values. To change the value of the parameter, select the indexed value and press the [CHANGE DATA] key. Using the [+] and [-] keys the value to be changed will flash. To accept the new setting, press [OK], to abort, press [CANCEL].

■ Initialisation to factory setting

The frequency converter can be initialised to factory settings in two ways.

Initialisation by parameter 620

- Recommended initialisation

- Select parameter 620
- Press [CHANGE]
- Select "Initialisation"
- Press the [OK] key
- Cut off the mains supply and wait until the display turns off.
- Reconnect the mains supply - the frequency converter is now reset.

This parameter initialises all except:

- 500 Serial communication address
- 501 Baud rate for serial communication
- 601-605 Operating data
- 615-617 Fault logs

Manual initialisation

- Disconnect from mains and wait until the display turns off.
- Press the following keys at the same time:
[Display/status]
[Change data]
[OK]
- Reconnecting the mains supply while pressing the keys.
- Release the keys
- The frequency converter has now been programmed for the factory setting.

This parameter initialises all except:

- 600-605 Operating data



NB!

Settings for serial communication and fault logs are reset.

■ Menu structure

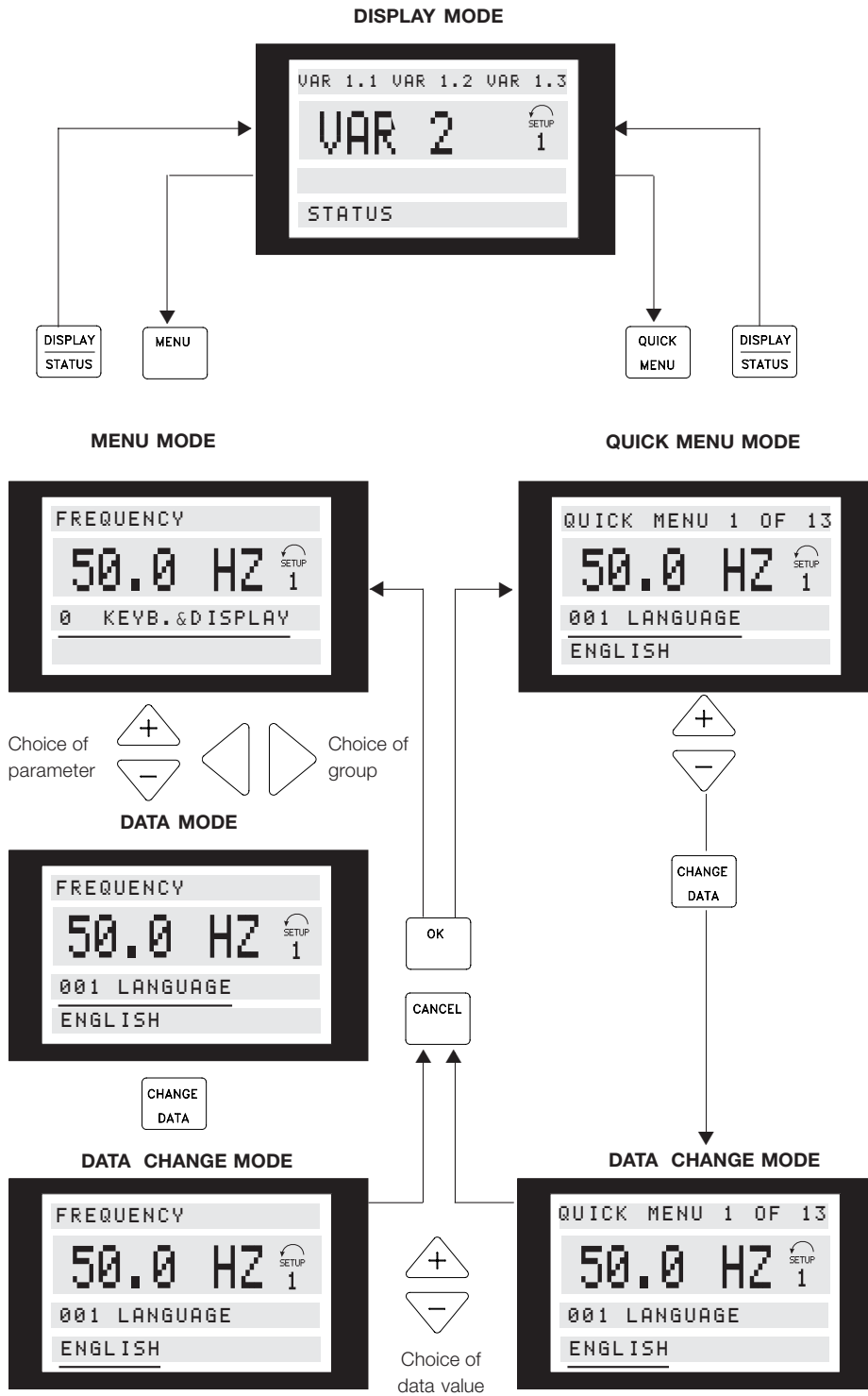

175ZA446.11

■ Connection examples

■ Two wire start/stop

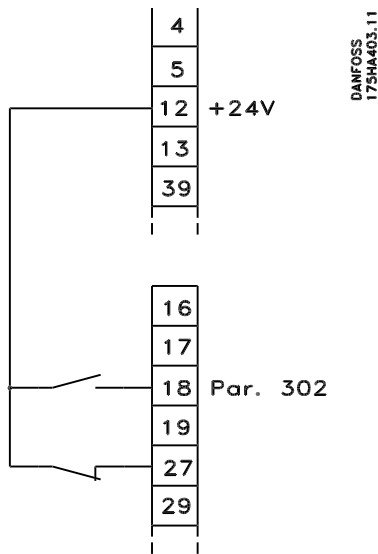

- Start/stop using terminal 18.
Parameter 302 = *Start* [1]
- Quick-stop using terminal 27.
Parameter 304 = *Coasting stop inverted* [0]

■ Pulse start/stop

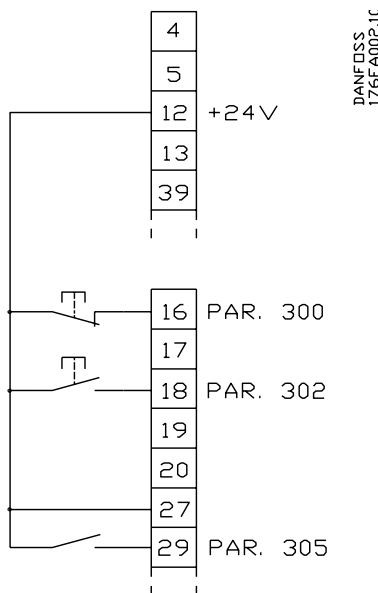

- Stop inverted by means of terminal 16.
Parameter 300 = *Stop inverted* [2]
- Pulse start using terminal 18.
Parameter 302 = *Pulse start* [2]
- Jog by means of terminal 29.
Parameter 305 = *Jog* [5]

■ Setup change

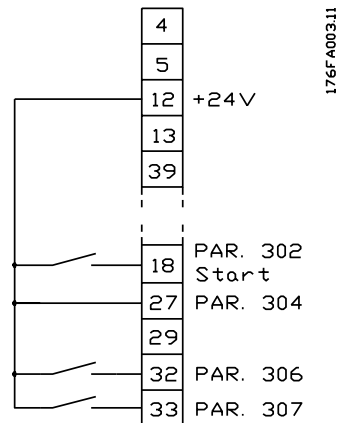

- Selection of setup using terminals 32 and 33.
Parameter 306 = *Selection of setup, lsb* [10]
Parameter 307 = *Selection of setup, msb* [10]
Parameter 004 = *Multi-setup* [5].

■ Digital speed up/down

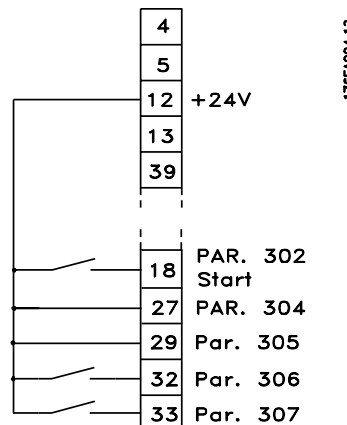

- Speed up and down using terminals 32 and 33.
Parameter 306 = *Speed up* [9]
Parameter 307 = *Speed down* [9]
Parameter 305 = *Freeze reference* [7].

■ Potentiometer reference

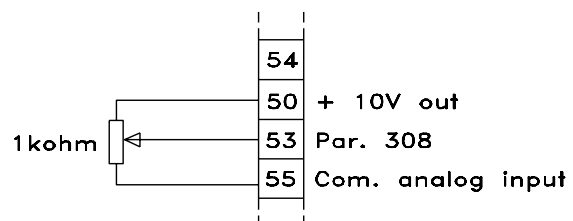

- Parameter 308 = *Reference* [1]
Parameter 309 = *Terminal 53, min. scaling*

Parameter 310 = Terminal 53, max. scaling

Two-wire transmitter

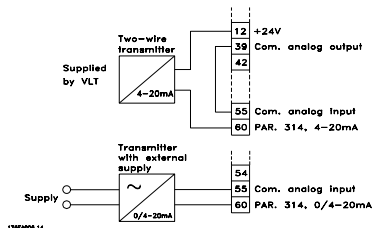

Parameter 314 = Reference [1], Feedback [2]

Parameter 315 = Terminal 60, min. scaling

Parameter 316 = Terminal 60, max. scaling

Current reference with speed feedback

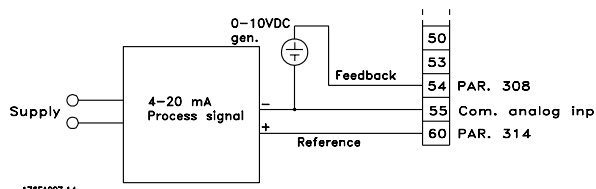

Parameter 100 = Speed control, closed loop

Parameter 308 = Feedback [2]

Parameter 309 = Terminal 53, min. scaling

Parameter 310 = Terminal 53, max. scaling

Parameter 314 = Reference [1]

Parameter 315 = Terminal 60, min. scaling

Parameter 316 = Terminal 60, max. scaling

Encoder connection

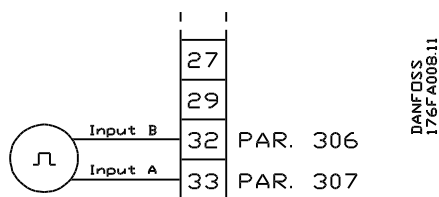

Parameter 306 = Encoder input B [24]

Parameter 307 = Encoder input A [25]

If an encoder is connected that only has one output to Encoder input A [25], Encoder input B [24] must be set to No function [0].

■ Application configuration

Using this parameter enables the choice of a configuration (setting) of the frequency converter that fits the application in which the frequency converter is to be active.



NB!

First, the motor nameplate date must be set in parameters 102-106.

- Speed control, open loop
- Speed control, closed loop
- Process control, closed loop
- Torque control, open loop
- Torque control, speed feedback

The selection of special motor characteristics can be combined with any application configuration.

There is a choice of the following configurations:

■ Setting of parameters

Select *Speed control, open loop* if a normal speed adjustment without external feedback signals is required

(the internal slip compensation is operating) from motor or unit.

Set the following parameters in order shown:

Speed control, open loop:			
Parameter:		Setting:	Data value:
100	Configuration	Speed control, open loop	[0]
200	Output frequency range/direction		
201	Output frequency low limit	Only if [0] or [2] in par. 200	
202	Output frequency high limit		
203	Reference/feedback range		
204	Minimum reference	Only if [0] in par. 203	
205	Maximum reference		

Select *Speed control, closed loop* if the application has a feedback signal and the accuracy in *Speed control, open loop* is not sufficient or a full holding torque is required.

Set the following parameters in order shown:

Speed control, closed loop (PID):			
Parameter:		Setting:	Data value:
100	Configuration	Speed control, closed loop	[1]
200	Output frequency range/direction	Output frequency low limit	
201	Output frequency low limit		
202	Output frequency high limit		
203	Reference/feedback range		
414	Minimum feedback	Only if [0] or [2] in par. 200	
415	Maximum feedback		
204	Minimum reference	Only if [0] in par. 203	
205	Maximum reference		
417	Speed PID proportional gain		
418	Speed PID integration time		
419	Speed PID differentiation time		
420	Speed PID diff. gain limit		
421	Speed PID lowpass filter time		

Please be aware that the encoder loss function (parameter 346) will be active when parameter 100 is set to *Speed control, closed loop*.

Select *Process control, closed loop* if the application has a feedback signal that is not directly related to motor speed (rpm/Hz), but units, such as temperature,

pressure, etc. Typical applications are pumps and fans. Set the following parameters in the order shown:

Process control, closed loop (Process PID):			
Parameter:		Setting:	Data value:
100	Configuration	Process control, closed loop	[3]
201	Output frequency low limit		
202	Output frequency high limit		
416	Process units	Define the feedback and reference input as described in the section <i>PID for process control</i> .	
203	Reference/feedback range		
204	Minimum reference	Only if [0] in par. 203	
205	Maximum reference		
414	Minimum feedback		
415	Maximum feedback		
437	Process PID normal/inverse		
438	Process PID anti-windup		
439	Process PID start frequency		
440	Process PID proportional gain		
441	Process PID integration time		
442	Process PID differentiation time	Only used in high dynamic applications	
443	Process PID diff. gain limit		
444	Process PID lowpass filter		

Select *Torque control, open loop* if PI control is required, to change the motor frequency in order to maintain the torque reference (Nm).

This is relevant for winding and extrusion applications.

Torque control, open loop, is to be selected if the speed direction is not to be changed during operation; this means that either a positive or a negative torque reference is used at all times.

Set the following parameters in order shown:

Torque control, open loop:			
Parameter:		Setting:	Data value:
100	Configuration	Torque control, open loop	[4]
200	Output frequency range/direction		
201	Output frequency low limit		
202	Output frequency high limit		
203	Reference/feedback range		
204	Minimum reference	Only if [0] in par. 203	
205	Maximum reference		
414	Minimum feedback		
415	Maximum feedback		
433	Torque proportional gain		
434	Torque integration time		

Select *Torque control, speed feedback*, if an encoder feedback signal is to be generated. This is relevant in winder and extruder applications.

Torque control, speed feedback, is selected if it is to be possible to change the speed direction, while at the same time maintaining the torque reference.

Set the following parameters in order shown:

Torque control, speed feedback:		
Parameter:	Setting:	Data value:
100	Configuration	Torque control, speed feedback [5]
200	Output frequency, range/direction	
201	Output frequency, low limit	
202	Output frequency, high limit	
203	Reference/feedback range	
204	Minimum reference	Only if [0] in par. 203
205	Maximum reference	
414	Minimum feedback	
415	Maximum feedback	
306	Encoder feedback, input B	[24]
307	Encoder feedback, input A	[25]
329	Encoder feedback, pulse/rev	
421	Speed PID low-pass filter time	
448	Gear ratio	
447	Torque regulation, speed feedback	
449	Friction loss	

After *Torque control, speed feedback*, has been selected, the frequency converter should be calibrated to ensure that the current torque equals the torque of the frequency converter. For this to be ensured, a torque gauge must be fitted to the shaft so as to enable accurate adjustment of parameter 447, *Torque compensation*, and parameter 449, *Friction loss*. It is recommended to run an AMA before torque calibration. Proceed as follows before beginning to use the system:

1. Fit a torque gauge to the shaft.
2. Start the motor with a positive torque reference and a positive direction of rotation. Read the torque gauge.

3. Using the same torque reference, change the direction of rotation from positive to negative. Read the torque and adjust it to the same level as for the positive torque reference and direction of rotation. This can be done by means of parameter 449, *Friction loss*.
4. Using a warm motor and approx. 50% load, set parameter 447, *Torque compensation*, to match the torque gauge. The frequency converter is now ready for operation.

Select *Special motor characteristics* if the frequency converter is to be adapted to a synchronous motor, parallel motor operation or if slip-compensation is not required.

Set the following parameters in order shown:

Special motor characteristics:		
Parameter:	Setting:	Data value:
101	Torque characteristics	Special motor characteristics [5] or [15]
432 + 431	F5 frequency/U5 voltage	
430 + 429	F4 frequency/U4 voltage	
428 + 427	F3 frequency/U3 voltage	
426 + 425	F2 frequency/U2 voltage	
424 + 423	F1 frequency/U1 voltage	
422	U0 voltage	

Local and remote control

The frequency converter can be operated manually or remotely. The following is a list of the functions/com-

mands given via the control panel, the digital inputs or the serial communication port in the two situations (modes).

If parameter 002 is set to Local [1]:

On the LCP, the following keys can be used for local control:

Key:	Parameter:	Data value:
[STOP]	014	[1] Enable
[JOG]	015	[1] Enable
[RESET]	017	[1] Enable
[FWD/REV]	016	[1] Enable

Set parameter 013 for LCP control and open loop [1] or LCP control as parameter 100 [3]:

1. Local reference is set in parameter 003; can be changed via the "+/-" keys.
2. Reversing can be effected by means of the [FWD/REV] key.

Set parameter 013 for LCP digital control and open loop [2] or LCP digital control as parameter 100 [4]:

For the above parameter setting, it is now possible to control the frequency converter as follows:

Digital inputs:

1. Local reference set in parameter 003 can be changed via the "+/-" keys.
2. Reset via digital terminal 16, 17, 29, 32 or 33.
3. Stop inverse via digital terminal 16, 17, 27, 29, 32 or 33.
4. Choice of Setup, lsb via digital terminal 16, 29 or 32.
5. Choice of Setup, msb via digital terminal 17, 29 or 33.
6. Ramp 2 via digital terminal 16, 17, 29, 32 or 33.
7. Quick-stop via digital terminal 27.
8. DC braking via digital terminal 27.

9. Reset and motor coasting stop via digital terminal 27.
10. Motor coasting stop via digital terminal 27.
11. Reversing via digital terminal 19.
12. Choice of Setup, msb/speed up via digital terminal 32.
13. Choice of Setup, lsb/speed down via digital terminal 33.

The serial communication port:

1. Ramp 2
2. Reset
3. Choice of Setup, lsb
4. Choice of Setup, msb
5. Relay 01
6. Relay 04

If parameter 002 is set to Remote control [0]:

Key:	Parameter:	Data value:
[STOP]	014	[1]
[JOG]	015	[1]
[RESET]	017	[1]

■ Control with brake function

The function of the brake is to limit the voltage in the intermediate circuit when the motor is acting as a generator. This occurs, for example, when the load drives the motor and the power enters the intermediate circuit. The brake is built up in the form of a chopper circuit with the connection of an external brake resistor. Placing the brake resistor externally offers the following advantages:

- The brake resistor can be selected on the basis of the application in question.
- The brake energy is dissipated outside the control panel, i.e. where the energy can be utilized.
- The electronics of the frequency converter will not be overheated if the brake resistor is overloaded.

The brake is protected against short-circuiting of the brake resistor, and the brake transistor is monitored to ensure that short-circuiting of the transistor is detected. By using a relay/digital output, the latter can be used for protecting the brake resistor against overloading in connection with a fault in the frequency converter.

In addition, the brake makes it possible to read out the momentary power and the mean power for the latest 120 seconds, as well as to monitor that the power energizing does not exceed a monitoring limit selected via parameter 402. In parameter 403 select the function to be carried out when the power transmitted to the brake resistor exceeds the limit set in parameter 402.



NB!

Monitoring of the brake power is not a safety function; a thermal switch is required for that purpose. The brake resistor circuit is not earth leakage protected.

■ Selection of Brake Resistor

In order to select the right brake resistor, it must be known how often to brake and by how much power braking is effected.

The resistor ED is an indication of the duty cycle at which the resistor is working.

The resistor ED is calculated as follows:

$$ED \text{ (duty cycle)} = \frac{tb}{T \text{ cycle}}$$

where tb is the braking time in seconds and T cycle is the total cycle time.

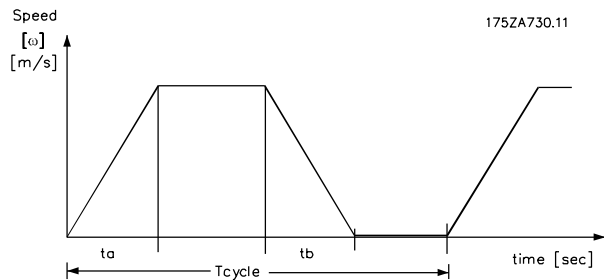

The maximum permissible load on the brake resistor is stated as a peak power at a given ED. The following example and formula apply to VLT 5000 only. The peak power can be calculated on the basis of the highest brake resistance required for braking:

$$P_{PEAK} = P_{MOTOR} \times M_{BR(\%)} \times \bullet_{MOTOR} \times \bullet_{VLT} [W]$$

where $M_{BR(\%)}$ is a percentage of the rated torque.

The brake resistance is calculated as follows:

$$R_{REC} = \frac{U^2_{DC}}{P_{PEAK}} [\Omega]$$

The brake resistance depends on the intermediate circuit voltage (UDC).

The brake will be active at the following voltages:

- 3 x 200-220 V: 397 V
- 3 x 380-500 V: 822 V
- 3 x 525-600 V: 943 V
- 3 x 525-690 V: 1084 V



NB!

The brake resistor used must be rated to 430 Volts, 850 Volts, 960 Volts or 1100 Volts, unless Danfoss brake resistors are used.

R_{REC} is the resistance recommended by Danfoss, i.e. one that guarantees the user that the frequency converter is able to brake at the highest braking torque (M_{br}) of 160%.

\bullet_{motor} is typically at 0.90, while \bullet_{VLT} is typically at 0.98.

R_{REC} at 160% braking torque can be written as:

$$R_{REC} = \frac{111.684}{P_{MOTOR}} [\Omega] \text{ at } 200 \text{ V}$$

$$R_{REC} = \frac{478.801}{P_{MOTOR}} [\Omega] \text{ at } 500 \text{ V}$$

$$R_{REC} = \frac{630.137}{P_{MOTOR}} [\Omega] \text{ at } 600 \text{ V}$$

$$R_{REC} = \frac{855.868}{P_{MOTOR}} [\Omega] \text{ at } 690 \text{ V}$$

P motor in kW.



NB!

The max. brake resistance selected should have an ohmic value max. 10% lower than that recommended by Danfoss. If a brake resistor with a higher ohmic value is selected, the 160% braking torque will not be achieved and there is a risk that the frequency converter will cut out for safety reasons. For further information, please consult Brake Resistor Instruction MI.90.FX.YY.



NB!

If a short circuit in the brake transistor occurs, power dissipation in the brake resistor can only be prevented by using a mains switch or contactor to disconnect the mains for the frequency converter. (The contactor can be controlled by the frequency converter).

■ References - single references

Using a single reference, only one active reference signal is connected, either in the form of an external or in the form of a preset (internal) reference.

The external reference can be voltage, current, frequency (pulse) or binary via the serial port. Two examples are given below of the way the single references are handled by VLT 5000 Series.

Example 1:

External reference signal = 1 V (min) - 5 V (max)

Reference = 5 Hz - 50 Hz

Configuration (parameter 100) - Speed control, open loop.

Single ref. / External U/f on terminal 53, 54 or 60. f (pulse) on terminal 17 or 29 binary (serial port).
 \ Preset references (par.215-218)

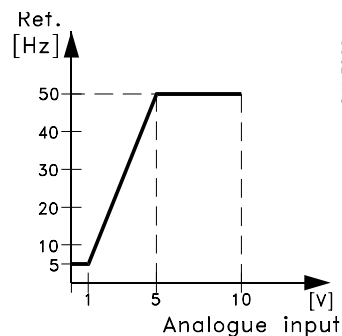

Setting:			
Parameter:		Setting:	Data value:
100	Configuration	Speed control, open loop	[0]
308	Funct. of analogue input	Reference	[1]
309	Min. reference signal	Min.	1 V
310	Max. reference signal	Max.	5 V
203	Reference range	Reference range	Min - Max [0]
204	Minimum reference	Min. reference	5 (Hz)
205	Maximum reference	Max. reference	50 (Hz)

The following can be used:

- Catch-up/slow-down via digital input terminals 16,17, 29, 32 or 33
- Freeze reference via digital input terminals 16,17, 29, 32 or 33.

Example 2:

External reference signal = 0 V (min) - 10 V (max)
 Reference = -50 Hz ccw - 50 Hz cw
 Configuration (parameter 100) =Speed control, open loop.

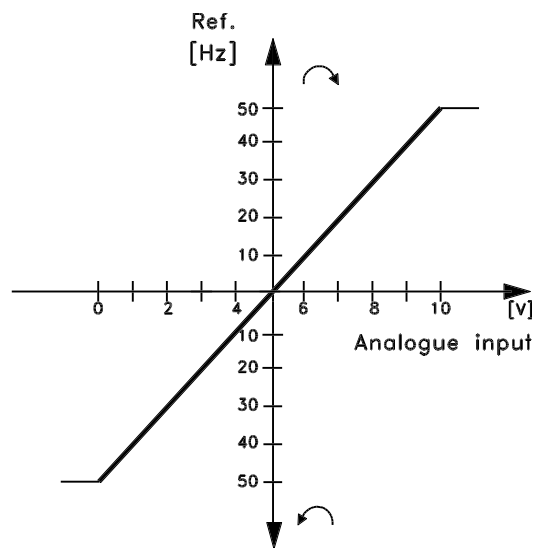

175ZA037.12

Setting:			
Parameter:		Setting:	Data value:
100	Configuration	Speed control, open loop	[0]
308	Funct. of analogue input	Reference	[1]
309	Min. reference signal	Min.	0 V
310	Max. reference signal	Max.	10 V
203	Reference range	Reference range	- Max - + Max [1]
205	Max. reference		100 Hz
214	Reference type	Sum	[0]
215	Preset reference		-50%
200	Output frequency range/direction	Both directions, 0-132 Hz	[1]

The following can be used:

- Catch-up/slow-down via digital input terminals 16,17, 29, 32 or 33
- Freeze reference via digital input terminals 16,17, 29, 32 or 33.

References - multi-references

If the multi-reference is used, two or more reference signals are connected, either in the form of external or preset reference signals. Via parameter 214 these can be combined in three different ways:

- / Sum
- Multi-ref. - Relative
- \ External/preset

In the following, each reference type (sum, relative and external/preset) is shown:

SUM

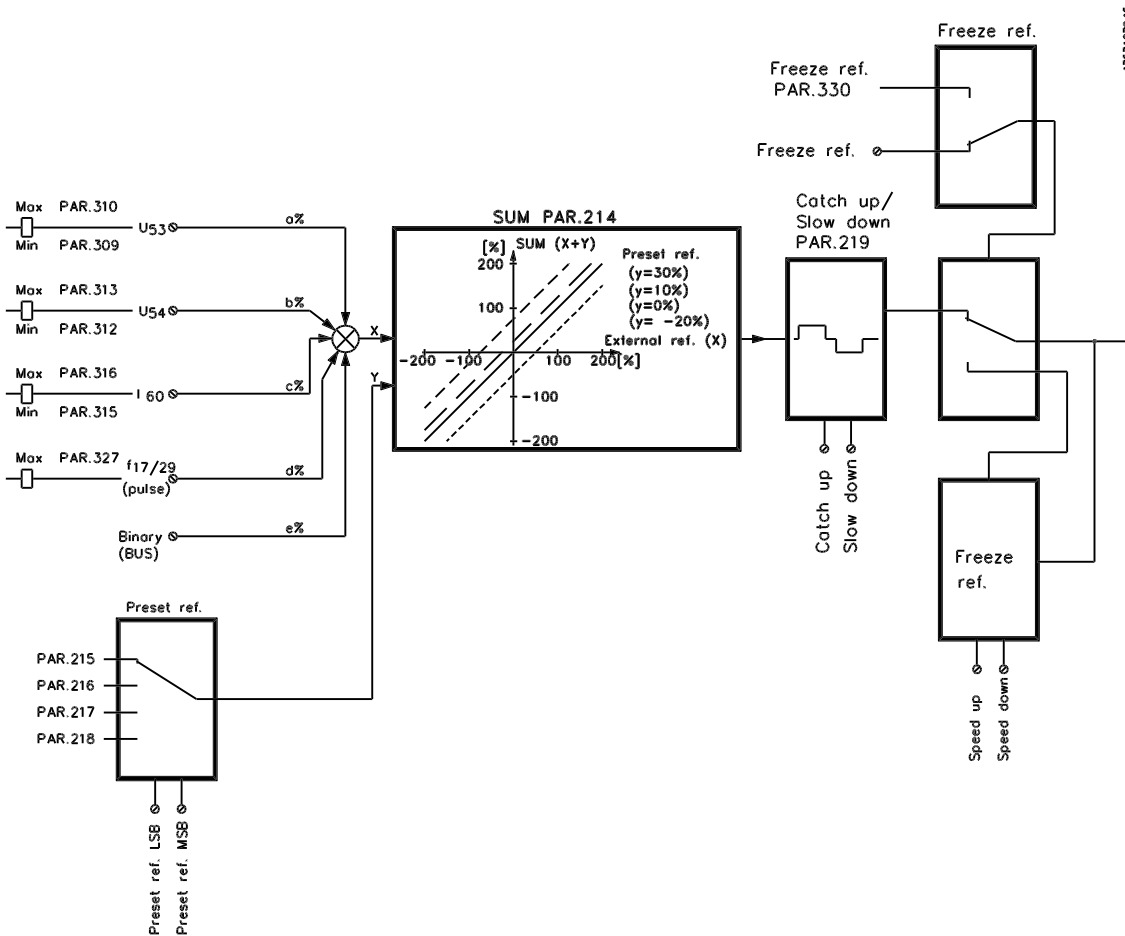
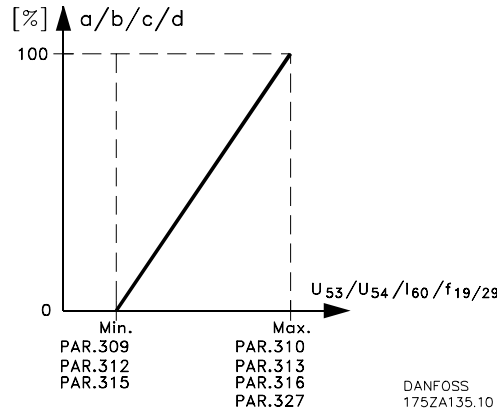

RELATIVE

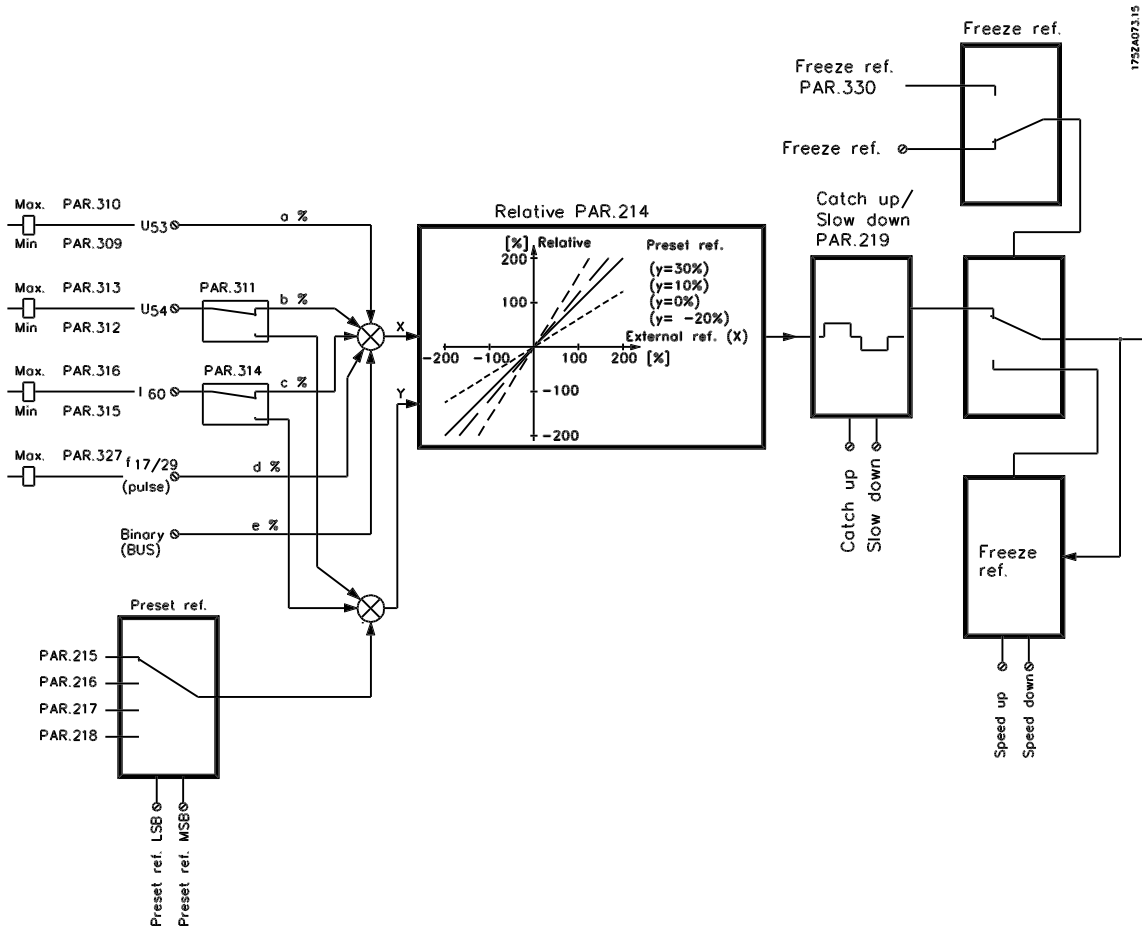

EXTERNAL/PRESET

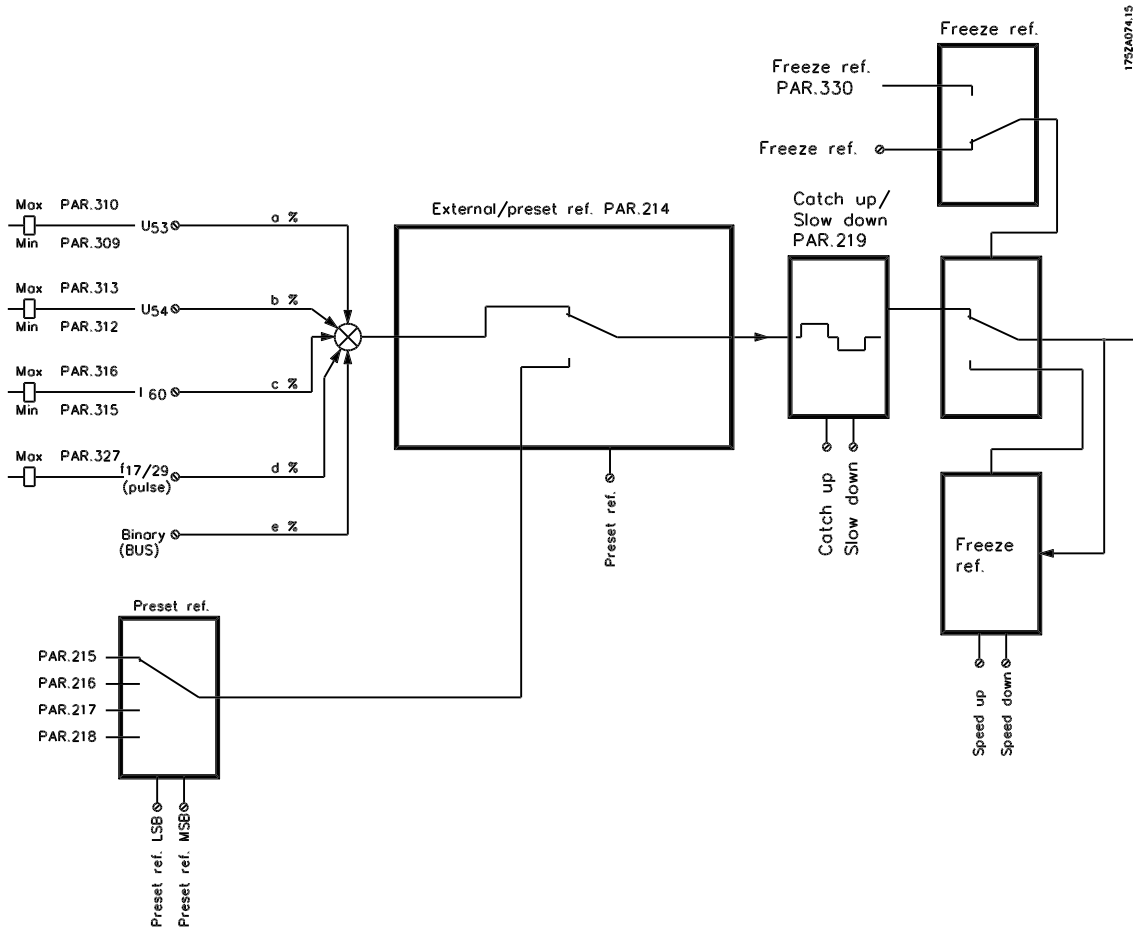

1752A07A.15

Special functions

References

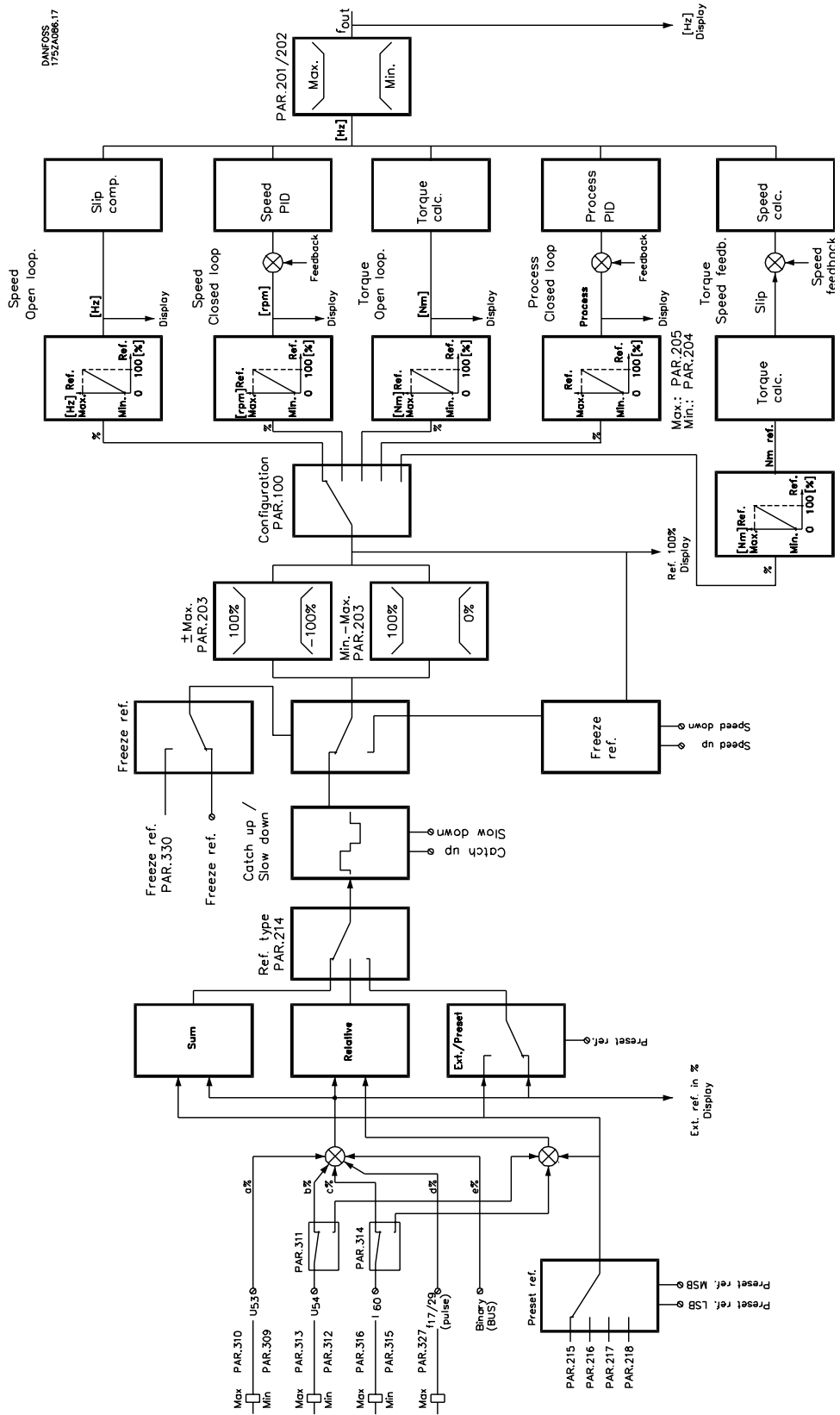

Automatic Motor Adaptation, AMA

Automatic motor adaptation is a test algorithm that measures the electrical motor parameters at a motor standstill. This means that AMA itself does not supply any torque.

AMA is useful when commissioning systems, where the user wants to optimise the adjustment of the frequency converter to the motor applied. This feature is used in particular where the factory setting does not adequately cover the motor in question.

There are two motor parameters that are of primary significance in automatic motor adaptation: the stator resistance, R_s , and the reactance at normal magnetising level, X_s . Parameter 107 allows a choice of automatic motor adaptation, with determination of both R_s and X_s , or reduced automatic motor adaptation with determination of only R_s .

The duration of a total automatic motor adaptation varies from a few minutes on small motors to more than 10 minutes on large motors.

Limitations and preconditions:

- For AMA to be able to determine the motor parameters optimally, the correct nameplate data for the motor connected to the frequency converter must be entered in parameters 102 to 106.
- For the best adjustment of the frequency converter, it is recommended to carry out AMA on a cold motor. Repeated AMA runs may lead to a heating of the motor that will result in an increase of the stator resistance, R_s .
- AMA can only be carried out if the rated motor current is minimum 35% of the rated output current of the frequency converter. AMA can be carried out up to one oversize motor.
- If a LC filter is inserted between the frequency converter and the motor, it will only be possible to carry out a reduced test. If an overall setting is required, remove the LC filter while running a total AMA. After completion of the AMA reinsert the LC filter.
- If motors are coupled in parallel only use reduced AMA if any.
- When using synchronous motors it is only possible to make a reduced AMA.
- Long motor cables can have an effect on the implementation of the AMA function if their resistance is bigger than the stator resistance of the motor.

How to perform an AMA

1. Press the [STOP/RESET] key
2. Set motor nameplate data in parameters 102 to 106
3. Select whether a total [ENABLE (RS,XS)] or a reduced [ENABLE RS] AMA is required in parameter 107
4. Connect terminal 12 (24 VDC) to terminal 27 on the control card
5. Press the [START] key or connect terminal 18 (start) to terminal 12 (24 VDC) to start the automatic motor adaptation.

Now the automatic motor adaptation goes through four tests (for reduced AMA only the first two tests). The different tests can be followed in the display as dots after the text **WORKING** in parameter 107:

1. Initial error check where nameplate data and physical errors are checked. Display shows **WORKING**.
2. DC test where the stator resistance is estimated. Display shows **WORKING..**
3. Transient test where the leakage inductance is estimated. Display shows **WORKING...**
4. .AC test where the stator reactance is estimated. Display shows **WORKING....**

NB!

AMA can only be carried out if there are no alarms during tuning.

Discontinue AMA

If the automatic motor adaptation is to be discontinued, press the [STOP/RESET] key or disconnect terminal 18 from terminal 12.

The automatic motor adaptation ends up with one of the following messages after the test:

Warnings and alarm messages
ALARM 21
Auto-optimisation OK

Press the [STOP/RESET] key or disconnect terminal 18 from terminal 12. This alarm indicates that the AMA is OK and that the drive is correctly adapted to the motor.

ALARM 22
**Auto-optimisation not OK
[AUTO MOTOR ADAPT OK]**

A fault has been found during automatic motor adaptation. Press the [STOP/RESET] key or disconnect

terminal 18 from terminal 12. Check the possible cause to the fault related to the alarm message given. The figure after the text is the error code, which can be seen in the fault log in parameter 615. Automatic motor adaptation does not update parameters. You may choose to run a reduced automatic motor adaptation.

CHECK P.103,105 [0]

[AUTO MOT ADAPT FAIL] Parameter 102, 103 or 105 has a wrong setting. Correct the setting and start AMA all over.

LOW P.105 [1]

The motor is too small for AMA to be carried out. If AMA is to be enabled, the rated motor current (parameter 105) must be higher than 35% of the rated output current of the frequency converter.

ASYMMETRICAL IMPEDANCE [2]

AMA has detected an asymmetrical impedance in the motor connected to the system. The motor could be defective.

MOTOR TOO BIG [3]

The motor connected to the system is too big for AMA to be carried out. The setting in parameter 102 does not match the motor used.

MOTOR TOO SMALL [4]

The motor connected to the system is too small for AMA to be carried out. The setting in parameter 102 does not match the motor used.

TIME OUT [5]

AMA fails because of noisy measuring signals. Try to start AMA all over a number of times, until AMA is carried out. Please note that repeated AMA runs may heat the motor to a level where the stator resistance RS is increased. In most cases, however, this is not critical.

INTERRUPTED BY USER [6]

AMA has been interrupted by the user.

INTERNAL FAULT [7]

An internal fault has occurred in the frequency converter. Contact your Danfoss supplier.

LIMIT VALUE FAULT [8]

The parameter values found for the motor are outside the acceptable range within which the frequency converter is able to work.

MOTOR ROTATES [9]

The motor shaft rotates. Make sure that the load is not able to make the motor shaft rotate. Then start AMA all over.

WARNING 39 - 42

A fault have been encountered during automatic motor adaptation. Check the possible fault causes in accordance with the warning message. Press the [CHANGE DATA key and select "CONTINUE" if AMA is to continue despite the warning or press the [STOP/RESET] key or disconnect terminal 18 from terminal 12 to discontinue AMA.

WARNING: 39**CHECK P.104,106**

The setting of parameter 102, 104 or 106 is probably wrong. Check the setting and choose `Continue' or `Stop'.

WARNING: 40**CHECK P.103,105**

The setting of parameter 102, 103 or 105 is probably wrong. Check the setting and choose `Continue' or `Stop'.

WARNING: 41**MOTOR TOO BIG**

The motor used is probably too big for AMA to be carried out. The setting in parameter 102 may not match the motor. Check the motor and choose `Continue' or `Stop'.

WARNING: 42**MOTOR TOO SMALL**

The motor used is probably too small for AMA to be carried out. The setting in parameter 102 may not match the motor. Check the motor and choose `Continue' or `Stop'.

■ Mechanical brake control

For hoisting applications, it is necessary to be able to control an electro-magnetic brake.

For controlling the brake, a relay output (01 or 04) is required. This output must be kept closed (voltage-free) during the time when the frequency converter is not able to 'hold' the motor, e.g. because of too high load. In parameter 323 or 326 (relay outputs 01, 04), select *Mechanical brake control* [32] or *Extended mechanical brake control* [34] for applications with an electro-magnetic brake.

During start/stop and ramp-down, the output current is monitored. If *Mechanical brake control* [32] is selected and the current is below the level selected in parameter 223 *Warning: Low current*, the mechanical brake is closed (voltage-free).

As a point of departure, a current can be selected which is approx. 70% of the magnetising current. Parameter 225 *Warning: Low frequency* states the frequency during ramp-down at which the mechanical brake is to close again.

If *Extended mechanical brake control* [34] is selected the mechanical brake is closed (voltage-free) during start until the output current is above the level selected in parameter 223 *Warning: Low Current*.

During stop mechanical brake is released until the frequency is below the level selected in parameter 225 *Warning: Low frequency*.

Notice by *Extended mechanical brake control* [34] that the brake does not close if the output current gets under parameter 223 *Warning: Low current*.

Nor does a current low level warning appear.

In extended mechanical brake mode an overcurrent trip (alarm 13) can be reset by an externally reset.

If the frequency converter is brought into an alarm condition or an overcurrent or overvoltage situation, the mechanical brake will immediately cut in.



NB!

The application shown is only for hoisting without counterweight.

Control of mechanical brake:

Parameter:	Setting:	Data value:
323 Relay 01 or par. 326 relay 04	Mechanical brake control	[32]
323 Relay 01 or par. 326 relay 04	Extended mechanical brake control	[34]
223 Warning: Low current	approx. 70% of magnetising current ¹⁾	
225 Warning: Low frequency	3-5 Hz ²⁾	
122 Function at stop	Pre-magnetisation	[3]
120 Start delay time	0.1-0.3 sec.	
121 Start function	Start frequency/voltage clockwise ³⁾	[3]
130 Start frequency	Set to slip frequency	
131 Initial voltage	The voltage must be corresponding to the frequency that has been set in parameter 130.	

1. During start and stop, the current limit in parameter 223 decides the switching level.
2. This value indicates the frequency during ramp-down at which the mechanical brake is to be closed again. This assumes that a stop signal has been given.
3. It must be ensured that the motor starts clockwise (hoist), since otherwise the frequency converter may drop the load. Switch U, V, W connections, if required.

Mechanical brake control

1757A953.11

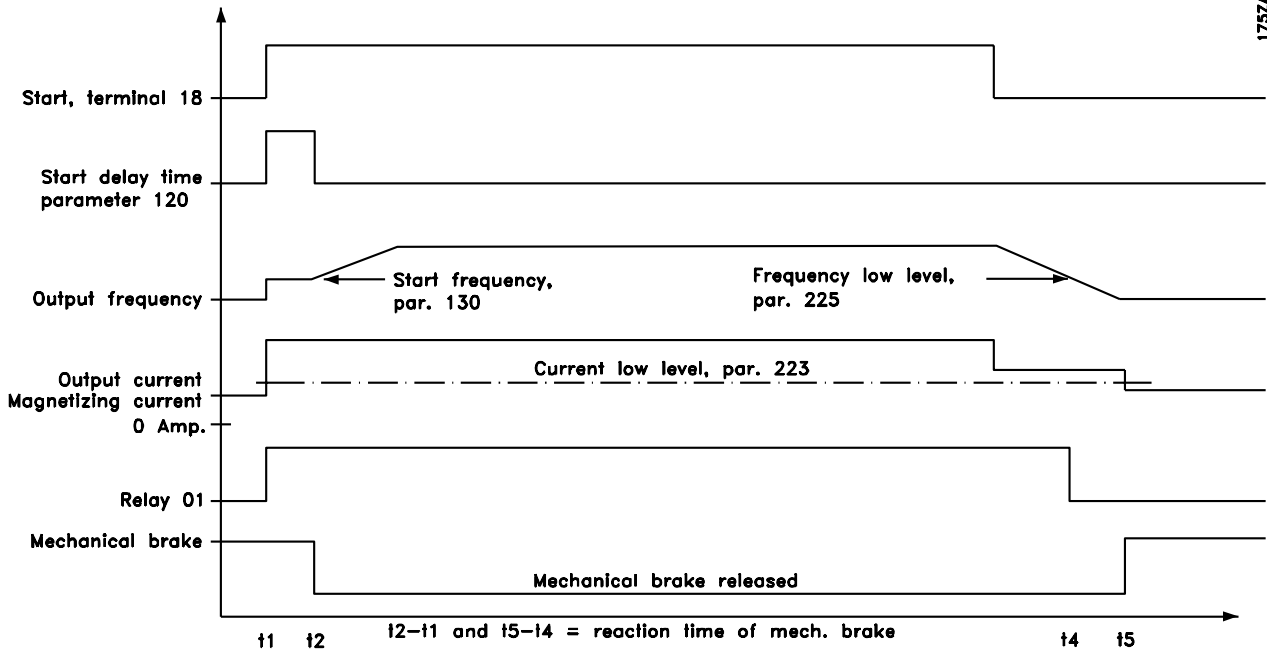

Extended mechanical brake control

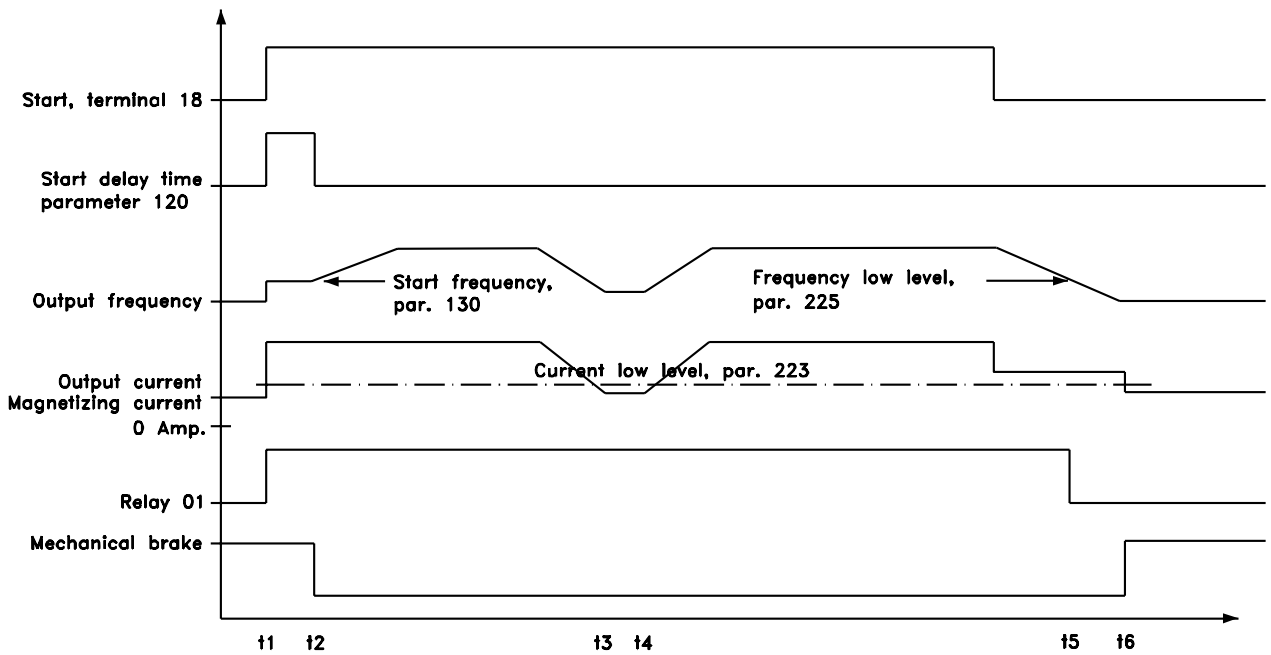

t_2-t_1 and t_6-t_5 = reaction time of mech. brake
 t_3-t_4 = motor current below current low level

■ PID for process control

Feedback

The feedback signal must be connected to a terminal on the frequency converter. Use the list below to decide which terminal is to be used and which parameters are to be programmed.

Feedback type	Terminal	Parameters
Pulse	33	307
Voltage	53	308, 309, 310
Current	60	314, 315, 316

Furthermore, the minimum and maximum feedback (parameters 414 and 415) must be set to a value in the process unit that corresponds to the minimum and maximum value on the terminal.

Select process unit in parameter 416.

Reference

A minimum and a maximum reference can be set (204 and 205), which limit the sum of all references. The reference range cannot exceed the feedback range. If one or several setpoint references are required, the simplest way is to set such reference directly in parameters 215 to 218. Select between the preset references by connecting terminals 16, 17, 29, 32 and/or 33 to terminal 12. Which terminals that are used depends on the choice made in the parameters of the various terminals (parameters 300, 301, 305, 306 and/or 307). Use the table below when selecting preset references.

	Preset ref. msb	Preset ref. lsb
Preset ref. 1 (par. 215)	0	0
Preset ref. 2 (par. 216)	0	1
Preset ref. 3 (par. 217)	1	0
Preset ref. 4 (par. 218)	1	1

If an external reference is required, this can either be an analogue or a pulse reference. If current is used as a feedback signal, only voltage can be used as an analogue reference. Use the following list to decide which terminal to use and which parameters to program.

Reference type	Terminal	Parameters
Pulse	17 or 29	301 or 305
Voltage	53 or 54	308, 309, 310 or 311, 312, 313
Current	60	314, 315, 316

Relative references can be programmed. A relative reference is a percentage value (Y) of the sum of the external references (X). This percentage value is add-

ed to the sum of the external references, which produces the active reference (X + XY). See section *Handling of multi references*.

If relative references are to be used, parameter 214 is to be set to *Relative* [1]. This makes the preset references relative. Furthermore, *Relative reference* [4] can be programmed on terminal 54 and/or 60. If an external relative reference is selected, the signal on the input will be a percentage value of the full range of the terminal. The relative references are added with signs.



NB!

Terminals that are not in use should preferably be set to *No function* [0].

Inverse control

If the drive has to react with increasing speed on and increasing feedback, *Inverse* must be selected in parameter 437. Normal control means that the motor speed decreases when the feedback signal increases.

Anti Windup

The process controller comes with the anti windup function in active position. This function ensures that when either a frequency limit or a torque limit is reached, the integrator will be set to a gain that corresponds to the actual frequency. This avoids integrating on an error that cannot in any case be compensated for by means of a speed change. This function can be disabled in parameter 438.

Start-up conditions

In some applications, optimum setting of the process controller will mean that it takes an excessive time for the desired process value to be reached. In such applications it might be an advantage to fix a motor frequency to which the frequency converter is to bring the motor before the process controller is activated. This is done by programming a *Process PID* start frequency in parameter 439.

Differentiator gain limit

If there are quick changes in reference or feedback in a given application - which means that the error changes swiftly - the differentiator may soon become too dominant. This is because it reacts to changes in the error. The quicker the error changes, the stronger the differentiator gain is. The differentiator gain can thus be limited to allow setting of the reasonable differentiation time for slow changes and a suitably quick gain for quick changes. This is done in parameter 443, *Process PID Differentiator gain limit*.

Lowpass filter

If there are oscillations of the current/voltage feedback signal, these can be dampened by means of a lowpass

filter. Set a suitable lowpass filter time constant. This time constant represents the limit frequency of the ripples occurring on the feedback signal. If the lowpass filter has been set to 0.1s, the limit frequency will be 10 RAD/sec., corresponding to $(10/2 \times \pi) = 1.6$ Hz. This will mean that all currents/voltages that vary by more than 1.6 oscillations per second will be removed by the filter. In other words, control will only be carried out on a feedback signal that varies by a frequency of less than 1.6 Hz. Choose a suitable time constant in parameter 444, *Process PID Lowpass filter*.

Optimisation of the process controller

The basic settings have now been made; all that needs to be done is to optimise the proportional gain, the integration time and the differentiation time (parameters 440, 441, 442). In most processes, this can be done by following the guidelines given below.

1. Start the motor
2. Set parameter 440 (proportional gain) to 0.3 and increase it until the feedback signal again begins to vary continuously. Then reduce the value until the feedback signal has stabilised. Now lower the proportional gain by 40-60%.
3. Set parameter 441 (integration time) to 20s and reduce the value until the feedback signal again begins to vary continuously. Increase the integration time until the feedback signal stabilises, followed by an increase of 15-50%.
4. Only use parameter 442 for very fast-acting systems only (differentiation time). The typical value is four times the set integration time. The differentiator should only be used when the setting of the proportional gain and the integration time has been fully optimised.



NB!

If necessary, start/stop can be activated a number of times in order to provoke a variation of the feedback signal.

See also the examples of connection given in the Design Guide.

■ PID for speed control

Feedback

Use the list below to decide which terminal to use for the feedback signal and which parameters to program.

Feedback type	Terminal	Parameters
Pulse	32	306
Pulse	33	307
Feedback pulse/rev.		329
Voltage	53	308, 309, 310
Current	60	314, 315, 316

Furthermore, the minimum and maximum feedback (parameters 414 and 415) are to be set to values in the process unit that correspond to the actual minimum and maximum process feedback values and units. The minimum feedback cannot be set to a value lower than 0. Choose unit in parameter 416.

Reference

A minimum and a maximum reference can be set (204 and 205) which limit the sum of all references. The reference range cannot exceed the feedback range.

If one or several preset references are required, the simplest way of doing this is by setting such references directly in parameters 215 to 218. Choose between the preset references by connecting terminals 16,17,29,32 and/or 33 to terminal 12. Which of them that are to be used depends on the choice in the parameters of the terminals in question (parameters 300, 301, 305, 306 and/or 307). The table below can be used to select the preset references.

	Preset ref. msb	Preset ref. lsb
Preset ref. 1 (par. 215)	0	0
Preset ref. 2 (par. 216)	0	1
Preset ref. 3 (par. 217)	1	0
Preset ref. 4 (par. 218)	1	1

If an external reference is required, this can either be an analogue reference or a pulse reference. If current is used as a feedback signal, voltage can be used as an analogue reference. Use the list below to decide which terminal to use and which parameters to program.

Reference type	Terminal	Parameters
Pulse	17 or 29	301 or 305
Voltage	53 or 54	308, 309, 310 or 311, 312, 313
Current	60	314, 315, 316

Relative references can be programmed. A relative reference is a percentage value (Y) of the sum of the external references (X). This percentage value is added to the sum of the external references, which pro-

duces the active reference (X + XY). See drawing on pages 62 and 63.

If relative references are to be used, parameter 214 is to be set to *Relative* [1]. This makes the preset references relative. Furthermore, *Relative reference* [4] can be programmed on terminal 54 and/or 60. If an external relative reference is selected, the signal on the input will be a percentage value of the full range of the terminal. The relative references are added with signs.



NB!

Terminals that are not in use should preferably be set to *No function* [0].

Differentiator gain limit

If there are quick changes in reference or feedback in a given application - which means that the error changes swiftly - the differentiator may soon become too dominant. This is because it reacts to changes in the error. The quicker the error changes, the stronger the differentiator gain is. The differentiator gain can thus be limited to allow setting of the reasonable differentiation time for slow changes and a suitable quick gain for quick changes. This is done in parameter 420, *Speed PID Differentiator gain limit*.

Lowpass filter

If are oscillations of the current/voltage on the feedback signal, these can be dampened by means of a lowpass filter. Set a suitable lowpass filter time constant. This time constant represents the limit frequency of the ripples occurring on the feedback signal. If the lowpass filter has been set to 0.1s, the break frequency will be 10 RAD/sec., corresponding to $(10/2 \times \pi) = 1.6$ Hz. This will mean that all currents/voltages that vary by more than 1.6 oscillations per second will be removed by the filter.

In other words, control will only be carried out on a feedback signal that varies by a frequency of less than 1.6 Hz. Choose a suitable time constant in parameter 421, *Speed PID Lowpass filter*.

■ Quick discharge

This function is only available in EB units (extended with brake) of the following type:

- VLT 5001-5052, 200-240 V
- VLT 5001-5102, 380-500 V
- 5001-5062, 525-600 V

This function is used for discharging the capacitors in the intermediate circuit after the mains supply has been interrupted. This is a useful function for servicing

the frequency converter and/or the motor installation. The motor must be stopped before quick discharge is activated. If the motor acts as a generator, quick discharge is not possible.

The quick discharge function can be selected via parameter 408. The function starts when the intermediate circuit voltage has dropped to a given value and the rectifier has stopped.

In order to obtain the possibility of a quick discharge, the frequency converter requires an external 24 V DC supply to terminals 35 and 36, as well as a suitable brake resistor on terminals 81 and 82.

For sizing of the discharge resistor for quick discharge, see Brake Instructions MI.50.DX.XX.



NB!

Quick discharge is only possible if the frequency converter has 24 Volts external DC supply and if an external brake/discharge resistor has been connected.



Before servicing the installation (frequency converter + motor), it must be checked that the intermediate circuit voltage is below 60 V DC. This is done by measuring terminals 88 and 89, load-sharing.



NB!

The power dissipation during quick discharge does not form part of the power monitoring function, parameter 403. When sizing resistors, this fact should be taken into consideration.

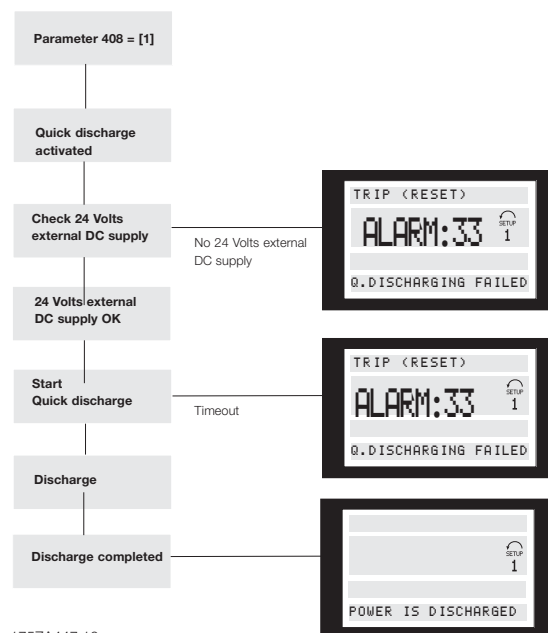

175ZA447.10

■ Mains failure/quick discharge with mains failure inverse

The first column in the table shows *Mains failure*, which is selected in parameter 407. If no function is selected, the mains failure procedure will not be carried out. If *Controlled ramp-down* [1] is selected, the frequency converter will take the motor down to 0 Hz. If *Enable* [1] has been selected in parameter 408, a quick discharge of the intermediate circuit voltage will be carried out after the motor has stopped.

Using a digital input, it is possible to activate mains failure and/or quick discharge. This is done by select-

ing *Mains failure inverse* on one of the control terminals (16, 17, 29, 32, 33). *Mains failure inverse* is active in the logical '0' situation.



NB!

The frequency converter can be completely damaged if the Quick-discharge function is repeated, using the digital input while mains voltage is on.

Mains failure par. 407	Quick discharge par. 408	Mains failure inverse digital input	Function
No function [0]	Disable [0]	Logical '0'	1
No function [0]	Disable [0]	Logical '1'	2
No function [0]	Enable [1]	Logical '0'	3
No function [0]	Enable [1]	Logical '1'	4
[1]-[4]	Disable [0]	Logical '0'	5
[1]-[4]	Disable [0]	Logical '1'	6
[1]-[4]	Enable [1]	Logical '0'	7
[1]-[4]	Enable [1]	Logical '1'	8

Function no. 1

Mains failure and quick discharge are not active.

Function no. 2

Mains failure and quick discharge are not active.

Function no. 3

The digital input activates the quick discharge function, regardless of the intermediate circuit voltage level and regardless of whether the motor is running.

Function no. 4

Quick discharge is activated when the intermediate circuit voltage has dropped to a given value and the inverters have stopped. See procedure on previous page.

Function no. 5

The digital input activates the mains failure function, regardless of whether the unit receives any supply voltage. See the different functions in parameter 407.

Function no. 6

The mains failure function is activated when the intermediate circuit voltage has dropped to a given value. The selected function in case of mains failure is selected in parameter 407.

Function no. 7

The digital input activates both the quick discharge and the mains failure function, regardless of the intermediate circuit voltage level and regardless of whether the motor is running. First the mains failure function will be active; subsequently there will be a quick discharge.

Function no. 8

Quick discharge and mains failure function are activated when the intermediate circuit level drops to a given level.

First the mains failure function will be active; subsequently there will be a quick discharge.

■ Flying start

This function makes it possible to "catch" a motor that is spinning freely and for the frequency converter to take control of the motor speed. This function can be enabled or disabled via parameter 445.

If *flying start* has been selected, there will be four situations in which the function is activated:

1. After a coast has been given via terminal 27.
2. After power-up.
3. If the frequency converter is in a trip state and a reset signal has been given.
4. If the frequency converter releases the motor because of a fault state and the fault disappears before a trip, the frequency converter will catch the motor and go back to the reference.

1. *Flying start* is active.

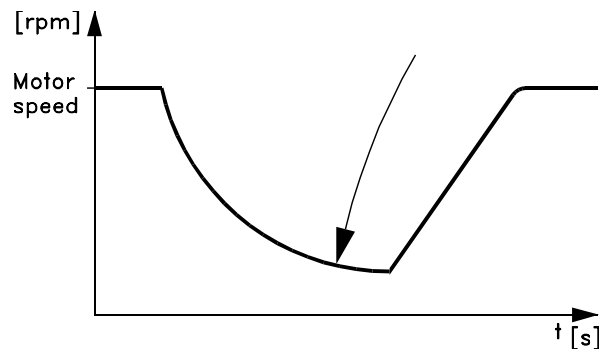

Term. 27

175ZA122.12

2. *Flying start* is active.

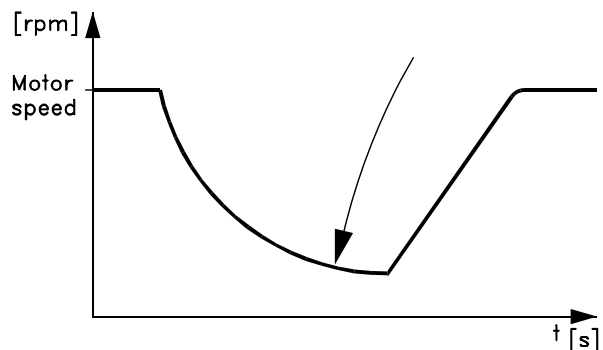

Mains switch

175ZA629.10

The search sequence for the spinning motor depends on *Rotation, frequency/direction* (parameter 200). If only *clockwise* is selected, the frequency converter will start looking from *Maximum frequency* (parameter 202) down to 0 Hz. If the frequency converter does not find the spinning motor during the search sequence, it will carry out a DC braking so as to try to bring the speed of the spinning motor down to 0 rpm. This requires that the DC brake is active via parameters 125 and 126. If *Both directions* is selected, the frequency converter will first find out in which direction the motor rotates and then search for the frequency. If the motor is not found, the system assumes that the motor is at a standstill or is rotating at a low speed, and the frequency converter will start the motor in the normal way after searching.

3. The frequency converter trips and *Flying start* is active.

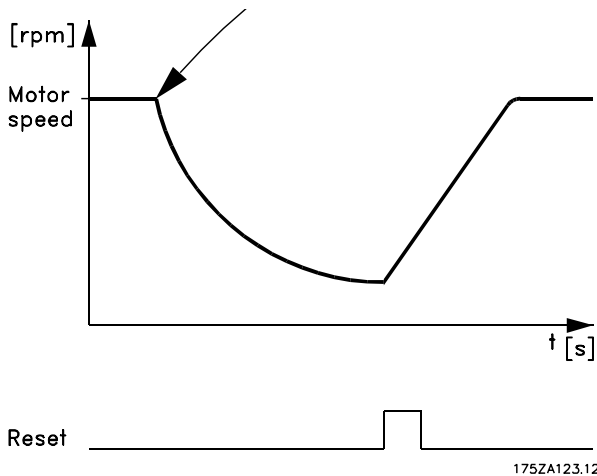

4. The frequency converter momentarily releases the motor. *Flying start* is activated and catches the motor again.

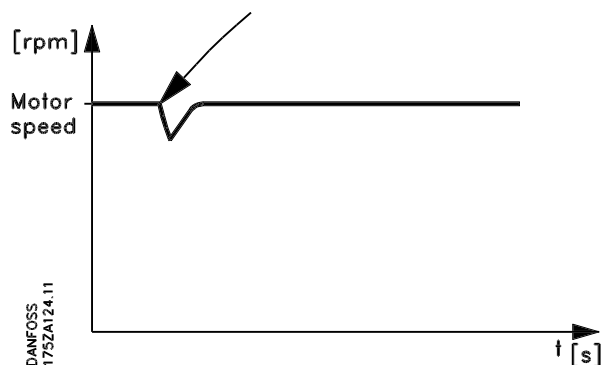

■ Normal/high overload torque control, open loop

This function enables the frequency converter to perform a constant 100% torque, using an oversize motor. The choice between a normal or a high overload torque characteristic is made in parameter 101.

This is also where to choose between a high/normal constant torque characteristic (CT) or a high/normal VT torque characteristic

If a *high torque characteristic* is chosen, a rated motor with the frequency converter obtains up to 160% torque for 1 min. in both CT and VT. If a *normal torque characteristic* is chosen, an oversize motor allows up to 110% torque performance for up to 1 min. in both CT and VT. This function is used mainly for pumps and fans, since these applications do not require an overload torque.

The advantage of choosing a normal torque characteristic for an oversize motor is that the frequency

converter will be able constantly to yield 100% torque, without derating as a result of a bigger motor.



NB!

This function cannot be chosen for VLT 5001-5006, 200-240 Volts, and VLT 5001-5011, 380-500 Volts.

■ Internal current regulator

The VLT 5000 features an integral current limit regulator which is activated when the motor current, and thus the torque, is higher than the torque limits set in parameter 221 and 222.

When VLT 5000 Series is at the current limit during motor operation or regenerative operation, the frequency converter will try to get below the preset torque limits as quickly as possible without losing control of the motor.

While the current regulator is active, the frequency converter can *only* be stopped by means of terminal 27 if set to *Coasting stop, inverse* [0] or *Reset and coasting stop, inverse* [1]. A signal on terminals 16-33 will *not* be active until the frequency converter has moved away from the current limit.

Please note that the motor will not use the ramp-down time, since terminal 27 must be programmed for *Coasting stop, inverse* [0] or *Reset and coasting stop, inverse* [1].

■ Programming of Torque limit and stop

In applications with an external electro-mechanical brake, such as hoisting applications, it is possible to stop the frequency converter via a 'standard' stop command, while at the same time activating the external electro-mechanical brake.

The example given below illustrates the programming of frequency converter connections.

The external brake can be connected to relay 01 or 04, see Control of mechanical brake on page 66. Program terminal 27 to *Coasting stop, inverse* [0] or *Reset and coasting stop, inverse* [1], as well as terminal 42 to *Torque limit and stop* [27].

Description:

If a stop command is active via terminal 18 and the frequency converter is not at the torque limit, the motor will ramp down to 0 Hz.

If the frequency converter is at the torque limit and a stop command is activated, terminal 42 *Output* (programmed to *Torque limit and stop* [27]) will be activated. The signal to terminal 27 will change from 'logic 1' to 'logic 0' and the motor will start coasting.

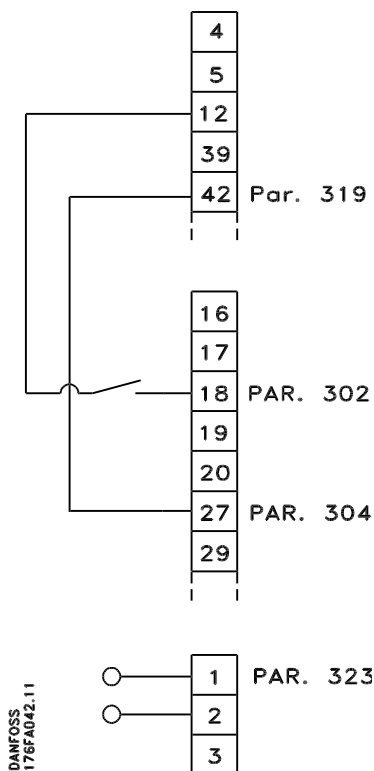

- Start/stop via terminal 18.
Parameter 302 = *Start* [1].
- Quickstop via terminal 27.
Parameter 304 = *Coasting stop, inverse* [0].
- Terminal 42 Output
Parameter 319 = *Torque limit and stop* [27].
- Terminal 01 Relay output
Parameter 323 = *Mechanical brake control* [32].

■ Parameters - Operation and Display

001 Language	
(LANGUAGE)	
Value:	
★ English (ENGLISH)	[0]
German (DEUTSCH)	[1]
French (FRANCAIS)	[2]
Danish (DANSK)	[3]
Spanish (ESPAÑOL)	[4]
Italian (ITALIANO)	[5]

Function:

The choice in this parameter defines the language to be used on the display.

Description of choice:

There is a choice of *English* [0], *German* [1], *French* [2], *Danish* [3], *Spanish* [4] and *Italian* [5].

002 Local/remote control	
(OPERATION SITE)	
Value:	
★ Remote control (REMOTE)	[0]
Local control (LOCAL)	[1]

Function:

There is a choice of two methods of controlling the frequency converter.

Description of choice:

If *Remote control* [0] is selected, the frequency converter can be controlled via:

1. The control terminals or the serial communication port.
2. The [START] key. However, this cannot override Stop commands (also start-disable) entered via the digital inputs or the serial communication port.
3. The [STOP], [JOG] and [RESET] keys, provided that these are active (see parameter 014, 015 and 017).

If *Local control* [1] is selected, the frequency converter can be controlled via:

1. The [START] key. However, this cannot override Stop commands on the digital terminals

(if [2] or [4] has been selected in parameter 013).

2. The [STOP], [JOG] and [RESET] keys, provided that these are active (see parameter 014, 015 and 017).
3. The [FWD/REV] key, provided that this has been activated in parameter 016 and that in parameter 013 a choice of [1] or [3] has been made.
4. Via P003 the local reference can be controlled by means of the "Arrow up" and "Arrow down" keys.
5. An external control command that can be connected to terminal 16, 17, 19, 27, 29, 32 or 33. However, [2] or [4] must be selected in parameter 013.

See also section *Shift between local and remote control*.

003 Local reference	
(LOCAL REFERENCE)	
Value:	
Par 013 set for [1] or [2]:	
0 - f_{MAX}	★ 50 Hz
Par 013 set for [3] or [4] and par. 203 = [0]	
set for:	
$Ref_{MIN} - Ref_{MAX}$	★ 0.0

Function:

This parameter allows manual setting of the desired reference value (speed or reference for the selected configuration, depending on the choice made in parameter 013).

The unit follows the configuration selected in parameter 100, provided *Process control, closed loop* [3] or *Torque control, open loop* [4] has been selected.

Description of choice:

Local [1] must be selected in parameter 002 for this parameter to be used.

The set value is saved in the case of a voltage drop-out, see parameter 019.

In this parameter Data Change Mode is not exited automatically (after time out).

Local reference cannot be set via the serial communication port.



Warning: Since the value set is remembered after the power has been cut, the motor may start without warning when the power is reinstated; if parameter 019 is changed to *Auto restart*, use *saved ref.* [0].

004 Active Setup

(ACTIVE SETUP)

Value:

Factory Setup (FACTORY SETUP)	[0]
★ Setup 1 (SETUP 1)	[1]
Setup 2 (SETUP 2)	[2]
Setup 3 (SETUP 3)	[3]
Setup 4 (SETUP 4)	[4]
MultiSetup (MULTI SETUP)	[5]

Function:

This parameter defines the Setup number to control the functions of the frequency converter. All parameters can be programmed in four individual parameter Setups, Setup 1 - Setup 4. In addition, there is a Factory Setup, which cannot be modified.

Description of choice:

Factory Setup [0] contains the data set at the works. Can be used as a data source if the other Setups are to be returned to a known state. Parameter 005 and 006 allow copying from one Setup to one or all the other Setups. *Setups 1-4* [1]-[4] are four individual Setups that can be selected individually. *Multi-Setup* [5] is used by remote-switching between Setups. Terminals 16/17/29/32/33 as well as the serial communication port can be used for switching between Setups.

005 Programming Setup

(EDIT SETUP)

Value:

Factory Setup (FACTORY SETUP)	[0]
Setup 1 (SETUP 1)	[1]
Setup 2 (SETUP 2)	[2]
Setup 3 (SETUP 3)	[3]
Setup 4 (SETUP 4)	[4]
★ Active Setup (ACTIVE SETUP)	[5]

Function:

The choice is of the Setup in which programming (change of data) is to occur during operation (applies both via the control panel and via the serial communication port). The 4 Setups can be programmed independently of the Setup selected as the active Setup (selected in parameter 004).

Description of choice:

The *Factory Setup* [0] contains the data set at the works and can be used as a data source if the other Setups are to be returned to a known state. *Setups 1-4* [1]-[4] are individual Setups which can be used as required. They can be programmed freely, regardless of the Setup selected as the active Setup and thus controlling the functions of the frequency converter.



NB!

If a general change of data or a copying to the active Setup is effected, this immediately affects the functioning of the unit.

006 Copying of Setups

(SETUP COPY)

Value:

★ No copying (NO COPY)	[0]
Copy to Setup 1 from # (COPY TO SETUP 1)	[1]
Copy to Setup 2 from # (COPY TO SETUP 2)	[2]
Copy to Setup 3 from # (COPY TO SETUP 3)	[3]
Copy to Setup 4 from # (COPY TO SETUP 4)	[4]
Copy to Setup all from # (COPY TO ALL)	[5]

= the Setup selected in parameter 005

Function:

A copy is made from the Setup selected in parameter 005 to one of the other Setups or to all the other Setups simultaneously. The setup copying function does not copy parameter 001, 004, 005, 500 and 501.

Copying is only possible in Stop Mode (motor stopped on a Stop command).

Description of choice:

The copying starts when the desired copying function has been entered and confirmed by pressing the [OK] key.

The display indicates when copying is in progress.

**007 LCP copy
(LCP COPY)**
Value:

★ No copying (NO COPY)	[0]
Upload all parameters (UPLOAD ALL PARAM)	[1]
Download all parameters (DOWNLOAD ALL)	[2]
Download power-independent par. (DOWNLOAD SIZE INDEP.)	[3]

Function:

Parameter 007 is used if it is desired to use the integrated copying function of the control panel. The control panel is detachable. You can therefore easily copy parameter value(s) from one to another.

Description of choice:

Select *Upload all parameters* [1] if all parameter values are to be transmitted to the control panel.

Select *Download all parameters* [2] if all transmitted parameter values are to be copied to the frequency converter on which the control panel has been mounted.

Select *Download power-independent par.* [3] if only the power-independent parameters are to be downloaded. This is used if downloading to a frequency converter that has a different rated power than the one from where the parameter Setup originates.

Please note that the power-dependent parameter 102-106 must be programmed after copying.

NB!

Uploading/Downloading can only be carried out in the Stop mode.

**008 Display scaling of motor frequency
(FREQUENCY SCALE)**
Value:

0.01 - 500.00 ★ 1

Function:

This parameter chooses the factor to be multiplied by the motor frequency, f_M , for presentation in the display, when parameters 009-012 have been set for Frequency x Scaling [5].

Description of choice:

Set the desired scaling factor.

009 Display line 2 (DISPLAY LINE 2)
Value:

No readout (NONE)	[0]
Reference [%] (REFERENCE [%])	[1]
Reference [unit] (REFERENCE [UNIT])	[2]
Feedback [unit] (FEEDBACK [UNIT])	[3]
★ Frequency [Hz] (FREQUENCY [Hz])	[4]
Frequency x Scaling [-] (FREQUENCY X SCALE)	[5]
Motor current [A] (MOTOR CURRENT [A])	[6]
Torque [%] (TORQUE [%])	[7]
Power [kW] (POWER [kW])	[8]
Power [HP] (POWER [hp] [US])	[9]
Output energy [kWh] (OUTPUT ENERGY [kWh])	[10]
Motor voltage [V] (MOTOR VOLTAGE [V])	[11]
DC link voltage [V] (DC LINK VOLTAGE [V])	[12]
Thermal load, motor [%] (MOTOR THERMAL [%])	[13]
Thermal load, VLT [%] (VLT THERMAL [%])	[14]
Hours run [Hours] (RUNNING HOURS)	[15]
Digital input [Binary code] (DIGITAL INPUT [BIN])	[16]
Analogue input 53 [V] (ANALOG INPUT 53 [V])	[17]
Analogue input 54 [V] (ANALOG INPUT 54 [V])	[18]
Analogue input 60 [mA] (ANALOG INPUT 60 [mA])	[19]
Pulse reference [Hz] (PULSE REF. [Hz])	[20]
External reference [%] (EXTERNAL REF [%])	[21]
Status word [Hex] (STATUS WORD [HEX])	[22]
Brake effect/2 min. [kW] (BRAKE ENERGY/2 min)	[23]
Brake effect/sec. [kW] (BRAKE ENERGY/s)	[24]
Heat sink temp. [°C] (HEATSINK TEMP [°C])	[25]
Alarm word [Hex] (ALARM WORD [HEX])	[26]
Control word [Hex] (CONTROL WORD [HEX])	[27]
Warning word 1 [Hex] (WARNING WORD 1 [HEX])	[28]
Warning word 2 [Hex] (WARNING WORD 2 [HEX])	[29]
Communication option card warning (Comm opt warn [hex])	[30]
RPM [min ⁻¹] (MOTOR RPM [RPM])	[31]

★ = factory setting, () = display text, [] = value for use in communication via serial communication port

RPM x scaling [-] (MOTOR RPM x SCALE)	[32]
LCP Display text (FREE PROG. ARRAY)	[33]

Function:

This parameter allows a choice of the data value to be displayed in line 2 of the display.

Parameters 010-012 enable the use of three additional data values to be displayed in line 1.

Description of choice:

No readout switches of the readout.

Reference [%] corresponds to the total reference (sum of digital/analogue/preset/bus/freeze ref./catch-up and slow-down).

Reference [unit] gives the status value of terminals 17/29/53/54/60 using the unit stated on the basis of configuration in parameter 100 (Hz, Hz and rpm).

Feedback [unit] gives the status value of terminal 33/53/60 using the unit/scale selected in parameter 414, 415 and 416.

Frequency [Hz] gives the motor frequency, i.e. the output frequency from the frequency converter.

Frequency x Scaling [-] corresponds to the present motor frequency f_M (without resonance dampening) multiplied by a factor (scaling) set in parameter 008.

Motor current [A] states the phase current of the motor measured as effective value.

Torque [%] gives the current motor load in relation to the rated motor torque.

Power [kW] states the actual power consumed by the motor in kW.

Power [HP] states the actual power consumed by the motor in HP.

Output energy [kWh] states the energy consumed by the motor since the latest reset was made in parameter 618.

Motor voltage [V] states the voltage supplied to the motor.

DC link voltage [V] states the intermediate circuit voltage in the frequency converter.

Thermal load, motor [%] states the calculated/estimated thermal load on the motor. 100% is the cut-out limit.

Thermal load, VLT [%] states the calculated/estimated thermal load on the frequency converter. 100% is the cut-out limit.

Hours run [Hours] states the number of hours that the motor has run since the latest reset in parameter 619.

Digital input [Binary code] states the signal states from the 8 digital terminals (16, 17, 18, 19, 27, 29, 32

and 33) Input 16 corresponds to the bit at the far left. '0' = no signal, '1' = connected signal.

Analogue input 53 [V] states the signal value on terminal 53.

Analogue input 54 [V] states the signal value on terminal 54.

Analogue input 60 [V] states the signal value on terminal 60.

Pulse reference [Hz] states the possible frequency in Hz connected to the terminals 17 or 29.

External reference [%] gives the sum of the external reference as a percentage (the sum of analogue/pulse/bus).

Status word [Hex] gives the status word sent via the serial communication port in Hex code from the frequency converter.

Brake power/2 min. [KW] states the brake power transferred to an external brake resistor. The mean power is calculated continuously for the latest 120 seconds.

It is assumed that a resistor value has been entered in parameter 401.

Brake power/sec. [kW] states the present brake power transferred to an external brake resistor. Stated as an instantaneous value.

It is assumed that a resistor value has been entered in parameter 401.

Heat sink temp. [°C] states the present heat sink temperature of the frequency converter. The cut-out limit is $90 \pm 5^\circ\text{C}$; cutting back in occurs at $60 \pm 5^\circ\text{C}$.

Alarm word [Hex] indicates one or several alarms in a Hex code. See *Alarm word*.

Control word. [Hex] indicates the control word for the frequency converter. See Serial communication in the Design Guide.

Warning word 1. [Hex] indicates one or more warnings in a Hex code. See *Warning word*.

Warning word 2. [Hex] indicates one or more status states in a Hex code. See *Warning word*.

Communication option card warning [Hex] gives a warning word if there is a fault on the communication bus. Is only active if communication options have been installed. Without communication options, 0 Hex is displayed.

RPM [min⁻¹] indicates the motor speed. In speed closed loop, the value is measured. In other modes the value is calculated based on the motor slip.

RPM x scaling [-] indicates the motor RPM multiplied by a factor set in parameter 008.

LCP display text shows the text programmed in parameter 553 *Display text 1* and 554 *Display text 2* via LCP or the serial communication port. Not possible in parameter 011-012.

★ = factory setting, () = display text, [] = value for use in communication via serial communication port

Display text 1 is only shown in full length if par 011 and 012 are set to None [0].

010	Display line 1.1 (DISPLAY LINE 1.1)
011	Display line 1.2 (DISPLAY LINE 1.2)
012	Display line 1.3 (DISPLAY LINE 1.3)

Value:

See parameter 009.

Function:

Parameter 010 - 012 enable a choice of three different data values to be shown on the display, line 1 position 1, line 1 position 2 and line 1 position 3, respectively. For display read-outs, press the [DISPLAY/STATUS] button.

The reading can be switched off.

Description of choice:

The factory setting for each parameter is the following:

Par. 010	Reference [%]
Par. 011	Motor current [A]
Par. 012	Power [kW]

013	Local Control/Configuration as parameter 100 (LOCAL CTRL/CONFIG.)
------------	--

Value:

Local not active (DISABLE)	[0]
LCP control and open loop. (LCP CTRL/OPEN LOOP)	[1]
LCP digital control and open loop. (LCP+DIG CTRL/OP.LOOP)	[2]
LCP control/as parameter 100. (LCP CTRL/AS P100)	[3]
★ LCP digital control/as parameter 100. (LCP+DIG CTRL/AS P100)	[4]

Function:

This is where the desired function is to be selected if Local control has been chosen in parameter 002. See also the description of parameter 100.

Description of choice:

If *Local not active* [0] is selected, a possible setting of *Local reference via parameter 003* is blocked. It is only possible to change to *Local not active* [0] from one of the other setting options in parameter 013, when the frequency converter has been set to *Remote control* [0] in parameter 002.

LCP control and open loop [1] is used when the speed is to be adjustable (in Hz) via parameter 003, when the frequency converter has been set to *Local control* [1] in parameter 002.

If parameter 100 has not been set to *Speed control open loop* [0], switch to *Speed control open loop* [0]

LCP digital control and open loop [2] functions as *LCP control and open loop* [1], the only difference being that when parameter 002 has been set to *Local operation* [1], the motor is controlled via the digital inputs, according to the list in section *Shift between local and remote control*.

LCP control/as parameter 100 [3] is selected if the reference is to be set via parameter 003.

LCP digital control/as parameter 100 [4] functions as *LCP control/as parameter 100* [3], although, when parameter 002 has been set to *Local operation* [1], the motor may be controlled via the digital inputs in accordance with the list in section *Shift between local and remote control*.



NB!

Shift from Remote control to LCP digital control and open loop:

The present motor frequency and direction of rotation must be maintained. If the present direction of rotation does not correspond to the reversing signal (negative reference), the motor frequency f_M will be set at 0 Hz.

Shift from LCP digital control and open loop to Remote control:

The selected configuration (parameter 100) will be active. Shifts are effected without any abrupt movement.

Shift from Remote control to LCP control/as parameter 100 or LCP digital control/as parameter 100.

The present reference will be maintained. If the reference signal is negative, the local reference will be set at 0.

Shift from LCP control/as parameter 100 or LCP remote control as parameter 100 to Remote control.

The reference will be replaced by the active reference signal from the remote control.

014	Local stop (LOCAL STOP)
------------	--------------------------------

Value:

Disable (DISABLE)	[0]
-------------------	-----

★ = factory setting, () = display text, [] = value for use in communication via serial communication port

★ Enable (ENABLE) [1]

Function:

This parameter disables/enables the local stop function from the LCP.

This key is used when parameter 002 has been set for *Remote control* [0] or *Local* [1].

Description of choice:

If *Disable* [0] is selected, the [STOP] key will be inactive.



NB!

If *Enable* is selected, the [STOP] key overrides all Start commands.

015 Local jog (LOCAL JOGGING)

Value:

- ★ Not possible (DISABLE) [0]
- Possible (ENABLE) [1]

Function:

This parameter enables/disables the local jog function on the LCP.

The key is used when parameter 002 has been set for *Remote control* [0] or *Local* [1].

Description of choice:

If *Disable* [0] is selected, the [JOG] key will be inactive.

016 Local reversing

(LOCAL REVERSING)

Value:

- ★ Not possible (DISABLE) [0]
- Possible (ENABLE) [1]

Function:

This parameter enables/disables the reversing function on the LCP.

This key can only be used if parameter 002 has been set to *Local operation* [1] and parameter 013 to *LCP control* [3].

Description of choice:

If *Disable* [0] is selected, the [FWD/REV] key will be inactive.

See parameter 200.

017 Local reset of trip (LOCAL RESET)

Value:

- Not possible (DISABLE) [0]
- ★ Possible (ENABLE) [1]

Function:

In this parameter, the reset function can be selected/removed from the keyboard.

This key can be used when parameter 002 has been set for *Remote control* [0] or *Local control* [1].

Description of choice:

If *Disable* [0] is selected in this parameter, the [RESET] key will be inactive.



NB!

Only select *Disable* [0] if an external reset signal has been connected via the digital inputs.

018 Lock for data change

(DATA CHANGE LOCK)

Value:

- ★ Not locked (NOT LOCKED) [0]
- Locked (LOCKED) [1]

Function:

In this parameter, the software can "lock" the control, which means that data changes cannot be made via LCP (however, this is still possible via the serial communication port).

Description of choice:

If *Locked* [1] is selected, data changes cannot be made.

019 Operating state at Power up, local control

(POWER UP ACTION)

Value:

- Auto restart, use saved ref. (AUTO RE-START) [0]
- ★ Forced stop, use saved ref. (LOCAL=STOP) [1]
- Forced stop, set ref. to 0 (LOCAL=STOP, REF=0) [2]

Function:

Setting of the operating mode when the mains voltage is reconnected.

This function can only be active in connection with *Local control* [1] in parameter 002.

Description of choice:

Auto restart, use saved ref. [0] is selected if the unit is to start up with the same local reference (set in parameter 003) and the same start/stop conditions (given via the [START/STOP] keys) that the frequency converter had before it was switched off.

Forced stop, use saved ref. [1] is used if the unit is to remain stopped when the mains voltage is connected, until the [START] key is pressed. After the start command, the local reference used is set in parameter 003.

Forced stop, set ref. to 0 [2] is selected if the unit is to remain stopped when the mains voltage is connected. Local reference (parameter 003) is reset.



NB!

In remote controlled operation (parameter 002), the start/stop condition at power up will depend on the external control signals. If *Pulse start* [2] is selected in parameter 302, the motor will remain stopped at power-up.

027 Warning readout line

(WARNING READOUT)

Value:

★ Warning in line 1/2	[0]
Warning in line 3/4	[1]

Function:

In this parameter it is decided in which line the warning is to appear in display mode. In programming mode (Menu or Quick menu) the warning will appear in line 1/2 to avoid disturbance of the programming.

Description of choice:

Select the readout line.

■ Parameters - Load and motor

100 Configuration (CONFIG. MODE)	
Value:	
★ Speed control, open loop (SPEED OPEN LOOP)	[0]
Speed control, closed loop (SPEED CLOSED LOOP)	[1]
Process control, closed loop (PROCESS CLOSED LOOP)	[3]
Torque control, open loop (TORQUE OPEN LOOP)	[4]
Torque control, speed feedback (TORQUE CONTROL SPEED)	[5]

Function:

This parameter is used for selecting the configuration to which the frequency converter is to be adapted. This makes adaptation to a given application simple, because the parameters that are not used in the given configuration are covered up (not active). By changing between the different application configurations, bumpless transfer (frequency only) is ensured.

Description of choice:

If Speed control, open loop [0] is selected, a normal speed control (without feedback signal) is obtained, but with automatic slip compensation, ensuring a nearly constant speed at varying loads.

Compensations are active, but may be disabled as required in parameter group 100.

If Speed control, closed loop [1] is selected, a full holding torque is obtained at 0 rpm, in addition to increased speed accuracy. A feedback signal must be provided and the PID regulator must be set. (See also connection examples in the Design Guide).

If Process control, closed loop [3] is selected, the internal process regulator will be activated, thereby enabling accurate control of a process with respect to a given process signal. The process signal can be set using the actual process unit or as a percentage. A feedback signal must be supplied from the process, and the process setpoint must be adjusted (See also connection examples in the Design Guide).

If Torque control, open loop [4] is selected, the speed is regulated and the torque is kept constant. This is done without a feedback signal, since VLT 5000 accurately calculates the torque on the basis of the cur-

rent measurement (See also connection examples in the Design Guide).

If Torque control, speed feedback [5] is selected, an encoder speed feedback signal must be connected to the digital terminals 32/33.

Parameter 205 *Maximum reference* and parameter 415 *Maximum feedback* must be adapted to the application if [1], [3], [4] or [5] is selected.

101 Torque characteristics (TORQUE CHARACT)	
Value:	
★ High-constant torque (H-CONSTANT TORQUE)	[1]
High-variable torque low (H-VAR.TORQ.: LOW)	[2]
High-variable torque medium (H-VAR.TORQ.: MEDIUM)	[3]
High-variable torque high (H-VAR.TORQ.: HIGH)	[4]
High-special motor characteristics (H-SPEC.MOTOR CHARACT)	[5]
High-variable torque with low starting torque (H-VT LOW W. CT-START)	[6]
High-variable torque with medium starting torque (H-VT MED W. CT-START)	[7]
High-variable torque with high starting torque (H-VT HIGH W. CT-START)	[8]
Normal-constant torque (N-CONSTANT TORQUE)	[11]
Normal-variable torque low (N-VAR.TORQ.: LOW)	[12]
Normal-variable torque medium (N-VAR.TORQ.: MEDIUM)	[13]
Normal-variable torque high (N-VAR.TORQ.: HIGH)	[14]
Normal-special motor characteristics (N-SPEC.MOTOR CHARACT)	[15]
Normal-variable torque with low constant starting torque (N-VT LOW W. CT-START)	[16]
Normal-variable torque with medium constant starting torque (N-VT MED W. CT-START)	[17]

★ = factory setting, () = display text, [] = value for use in communication via serial communication port

Normal-variable torque with high constant starting torque
(N-VT HIGH W. CT-START) [18]

Function:

In this parameter, the principle for adjusting the U/f characteristics of the frequency converter to the torque characteristics of the load is selected. By changing between the different torque characteristics, bumpless transfer (voltage only) is ensured.

Description of choice:



NB!

For VLT 5001-5006, 200-240 V, VLT 5001-5011, 380-500 V, and VLT 5011, 550-600 V it is only possible to choose torque characteristics from [1] to [8].

If a high torque characteristic [1]-[5] is selected, the frequency converter is able to provide 160% torque. If a normal torque characteristic [11]-[15] is selected, the frequency converter is able to provide 110% torque. The normal mode is used for oversize motors. Please note that the torque can be limited in parameter 221.

If *Constant torque* is selected, a load-dependent U/f characteristic is obtained in which the output voltage is increased in the case of an increasing load (current) so as to maintain constant magnetisation of the motor. Select *Variable torque low*, *Variable torque medium* or *Variable torque high* if the load is variable (centrifugal pumps, fans).

Select *High-variable torque with low* [6], *medium* [7] or *high* [8] starting torque if a higher breakaway torque is required than that obtainable with the three first-mentioned characteristics, see fig. below.

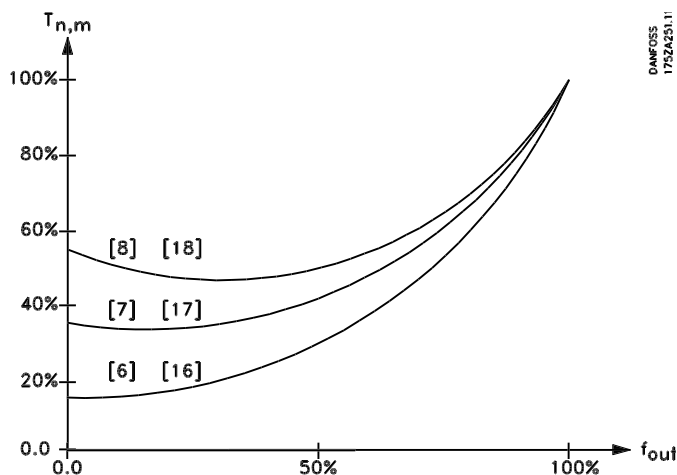

Choose the torque characteristics giving the most reliable operation, the lowest possible energy consumption and the lowest acoustic noise.

Select *Special motor characteristics* if a special U/f setting is required to match the motor in question. Set the break points in parameters 422-432.



NB!

Slip compensation is not active if a variable torque or special motor characteristics are used.

102 Motor power (MOTOR POWER)

Value:

0.18 kW (0.18 KW)	[18]
0.25 kW (0.25 KW)	[25]
0.37 kW (0.37 KW)	[37]
0.55 kW (0.55 KW)	[55]
0.75 kW (0.75 KW)	[75]
1.1 kW (1.10 KW)	[110]
1.5 kW (1.50 KW)	[150]
2.2 kW (2.20 KW)	[220]
3 kW (3.00 KW)	[300]
4 kW (4.00 KW)	[400]
5.5 kW (5.50 KW)	[550]
7.5 kW (7.50 KW)	[750]
11 kW (11.00 KW)	[1100]
15 kW (15.00 KW)	[1500]
18.5 kW (18.50 KW)	[1850]
22 kW (22.00 KW)	[2200]
30 kW (30.00 KW)	[3000]
37 kW (37.00 KW)	[3700]
45 kW (45.00 KW)	[4500]
55 kW (55.00 KW)	[5500]
75 kW (75.00 KW)	[7500]
90 kW (90.00 KW)	[9000]
110 kW (110.00 KW)	[11000]
132 kW (132.00 KW)	[13200]
160 kW (160.00 KW)	[16000]
200 kW (200.00 KW)	[20000]
250 kW (250.00 KW)	[25000]
280 kW (280.00 KW)	[28000]
315 kW (315.00 KW)	[31500]
355 kW (355.00 KW)	[35500]
400 kW (400.00 KW)	[40000]
450 kW (450.00 KW)	[45000]

500 kW (500.00 KW)	[50000]
530 kW (530.00 KW)	[53000]
560 kW (560.00 KW)	[56000]
630 kW (630.00 KW)	[63000]

Depends on the unit

Function:

Selects the kW value that corresponds to the rated power of the motor.
A rated kW value has been selected from the factory that depends on the unit size.

Description of choice:

Select a value that equals the nameplate data on the motor. There are 4 possible undersizes or 1 oversize in comparison with the factory setting.
Also, alternatively it is possible to set the value for motor power as an infinitely variable value.
The set value automatically changes the values of the motor parameters in parameter 108-118.



NB!

If the setting in parameter 102-109 is changed, parameter 110-118 will return to factory setting.

103 Motor voltage (MOTOR VOLTAGE)

Value:

200 V	[200]
208 V	[208]
220 V	[220]
230 V	[230]
240 V	[240]
380 V	[380]
400 V	[400]
415 V	[415]
440 V	[440]
460 V	[460]
480 V	[480]
500 V	[500]
550 V	[550]
575 V	[575]
660 V	[660]
690 V	[690]

Depends on the unit.

Function:

Select a value that equals the nameplate data on the motor.



NB!

The motor will always see the peak voltage, corresponding to the connected supply voltage, in case of regenerative operation, the voltage can be higher.

Description of choice:

Select a value that equals the nameplate data on the motor, regardless of the mains voltage of the frequency converter. Furthermore, alternatively it is possible to set the value of the motor voltage infinitely variable. The value set automatically changes values for the motor parameters in parameters 108-118.
For 87 Hz operation with 230/400 V motors, set the nameplate data for 230 V. Adapt parameter 202 *Output frequency high limit* and parameter 205 *Maximum reference* to the 87 Hz application.



NB!

If a delta connection is used, the rated motor frequency for the delta connection must be selected.



NB!

If the setting in parameter 102-109 is changed, the parameters 110-118 will return to factory setting. If using special motor characteristics a change in parameter 102-109 affects parameter 422.

104 Motor frequency

(MOTOR FREQUENCY)

Value:

★ 50 Hz (50 HZ)	[50]
60 Hz (60 HZ)	[60]

Max. motor frequency 1000 Hz.

Function:

This is where the rated motor frequency $f_{M,N}$ is selected (nameplate data).

Description of choice:

Select a value that equals the nameplate data on the motor.

VLT® 5000 Series

Alternatively it is also possible to set the value for motor frequency infinitely variably, see chapter *Operation of the frequency converter*.

If a value different from 50 Hz or 60 Hz is selected, it is necessary to correct parameters 108 and 109.

For 87 Hz operation with 230/400 V motors, set the nameplate data for 230 V. Adapt parameter 202 *Output frequency high limit* and parameter 205 *Maximum reference* to the 87 Hz application.



NB!

If a delta connection is used, the rated motor frequency for the delta connected must be selected.



NB!

If the setting in parameter 102-109 is changed, the parameters 110-118 will return to factory setting. If using special motor characteristics a change in parameter 102-109 affects parameter 422.

105 Motor current (MOTOR CURRENT)

Value:

0.01 - I_{VLT,MAX} [0.01 - XXX.X]

Depends on the choice of motor.

Function:

The rated motor current I_{M,N} forms part of the frequency converter calculations i.a. of torque and motor thermal protection.

Description of choice:

Select a value that equals the nameplate data on the motor.

Enter the value in Ampere.



NB!

It is important to enter the correct value, since this forms part of the VVC^{plus} control feature.



NB!

If the setting in parameter 102-109 is changed, the parameters 110-118 will return to factory setting. If using special motor characteristics a change in parameter 102-109 affects parameter 422.

106 Rated motor speed

(MOTOR NOM. SPEED)

Value:

100 - 60000 rpm (rpm) [100 - 60000]

Depends on the choice of motor.

Function:

This is where the value is selected that corresponds to the rated motor speed n_{M,N}, which can be seen from the nameplate data.

Description of choice:

The rated motor speed n_{M,N} is used i.a. for calculating the optimal slip compensation.



NB!

It is important to enter the correct value, since this forms part of the VVC^{plus} control feature. The max. value equals f_{M,N} x 60. Set f_{M,N} in parameter 104.



NB!

If the setting in parameter 102-109 is changed, the parameters 110-118 will return to factory setting. If using special motor characteristics a change in parameter 102-109 affects parameter 422.

107 Automatic motor adaptation, AMA

(AUTO MOTOR ADAPT)

Value:

- ★ Adaptation off (OFF) [0]
- Adaptation on, R_s and X_s (ENABLE (RS,XS)) [1]
- Adaptation on, R_s (ENABLE (RS)) [2]

Function:

If this function is used, the frequency converter automatically sets the necessary control parameters (parameters 108/109) with the motor stationary. Automatic motor adaptation ensures optimum use of the motor. For the best possible adaptation of the frequency converter, it is recommended to run AMA on a cold motor.

The AMA function is activated by pressing the [START] key after selecting [1] or [2].

See also section *Automatic motor adaptation*.

The section *Automatic motor adaptation, AMA, via VLT software dialog* shows how automatic motor adaptation

can be activated by means of VLT Software Dialog. After a normal sequence, the display will read "ALARM 21". Press the [STOP/RESET] key. The frequency converter is now ready for operation.

Description of choice:

Select *Enable, R_S and X_S* [1] if the frequency converter is to be able to carry out automatic motor adaptation of both the stator resistance R_S and the stator reactance X_S.

Select *Optimisation on, R_S* [2] if a reduced test is to be carried out, in which only the ohmic resistance in the system is determined.



NB!

It is important to set motor parameters 102-106 correctly, since these form part of the AMA algorithm. In most applications, correct entering of motor parameters 102-106 is sufficient. For optimum dynamic motor adaptation, an AMA must be carried out.

Motor adaptation may take up to 10 minutes, depending on the output of the motor in question.



NB!

There must not be any externally generating torque during automatic motor adaptation.



NB!

If the setting in parameter 102-109 is changed, the parameters 110-118 will return to factory setting. If using special motor characteristics a change in parameter 102-109 affects parameter 422.

108 Stator resistor (STATOR RESIST)

Value:

★ Depends on the choice of motor

Function:

After setting motor data in parameters 102-106, a number of adjustments of various parameters are made automatically, including the stator resistance R_S. A manually entered R_S must apply to a cold motor. The shaft performance can be improved by fine-tuning R_S and X_S, see procedure below.

Description of choice:

R_S can be set as follows:

1. Automatic motor adaptation, where the frequency converter measures on the motor to determine the value. All compensations are reset to 100%.
2. The values are stated by the motor supplier.
3. The values are obtained by means of manual measurements:
 - R_S can be calculated by measuring the resistance R_{PHASE-to-PHASE} between two phase terminals. If R_{PHASE-to-PHASE} is lower than 1-2 ohm (typically motors >4-5.5 kW, 400 V), a special ohm-meter should be used (Thomson bridge or similar). $R_S = 0.5 \times R_{PHASE-to-PHASE}$
4. The factory settings of R_S, selected by the frequency converter itself on the basis of the motor nameplate data, are used.



NB!

If the setting in parameter 102-109 is changed, the parameters 110-118 will return to factory setting. If using special motor characteristics a change in parameter 102-109 affects parameter 422.

109 Stator reactance

(STATOR REACT.)

Value:

★ depends on the choice of motor

Function:

After setting motor data in parameters 102-106, a number of adjustments of various parameters are made automatically, including the stator reactance X_S. The shaft performance can be improved by fine-tuning R_S and X_S, see procedure below.

Description of choice:

X_S can be set as follows:

1. Automatic motor adaptation, where the frequency converter measures on the motor to determine the value. All compensations are reset to 100%.
2. The values are stated by the motor supplier.

3. These values are obtained by means of manual measurements:

- X_S can be calculated by connecting a motor to mains and measuring the phase-to-phase voltage U_L as well as the idling current I_ϕ .

Alternatively, these values can be recorded during operation in idle running state at the rated motor frequency $f_{M,N}$, slip compensation (par. 115) = 0% and load compensation at high speed (par. 114) = 100%.

$$X_S = \frac{U_L}{\sqrt{3} \times I_\phi}$$

4. The factory settings of X_S , selected by the frequency converter itself on the basis of the motor nameplate data, are used.



NB!

If the setting in parameter 102-109 is changed, the parameters 110-118 will return to factory setting. If using special motor characteristics a change in parameter 102-109 affects parameter 422.

110 Motor magnetizing, 0 rpm (MOT. MAGNETIZING)

Value:
0 - 300 % ☆ 100 %

Function:

This parameter can be used if a different thermal load on the motor is desired when running at low speed. This parameter is used in connection with parameter 111.

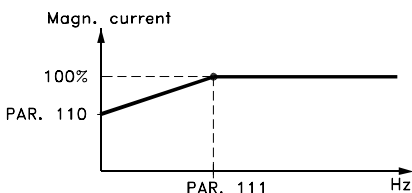

Description of choice:

Enter a value stated as a percentage of the rated magnetizing current. Too low setting may lead to a reduced torque on the motor shaft.

111 Min. frequency normal magnetizing (MIN FR NORM MAGN)

Value:
0.1 - 10.0 Hz ☆ 1.0 Hz

Function:

This parameter is used in connection with parameter 110. See drawing in parameter 110.

Description of choice:

Set the required frequency (for normal magnetizing current). If the frequency is set lower than the motor slip frequency, parameters 110 and 111 are of no significance.

113 Load compensation at low speed (LO SPD LOAD COMP)

Value:
0 - 300 % ☆ 100 %

Function:

This parameter enables compensation of voltage in relation to load when the motor is running at low speed.

Description of choice:

Optimum U/f characteristics are obtained, i.e. compensation for the load at low speed. The frequency range within which *Load compensation at low speed* is active, depends on the motor size.

This function is active for:

Motor size	Change-over
0.5 kW - 7.5 kW	< 10 Hz
11 kW - 45 kW	< 5 Hz
55 kW - 355 kW	< 3-4 Hz

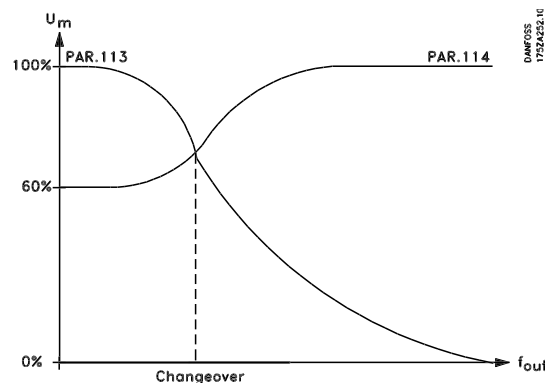

114 Load compensation at high speed (HI SPD LOAD COMP)

Value:

☆ = factory setting, () = display text, [] = value for use in communication via serial communication port

0 - 300 %

★ 100 %

Function:

This parameter enables compensation of voltage in relation to load when the motor is running at high speed.

Description of choice:

In *Load compensation at high speed* it is possible to compensate for the load from the frequency where *Load compensation at low speed* stopped working to max. frequency.

This function is active for:

Motor size	Change-over
0.5 kW - 7.5 kW	>10 Hz
11 kW - 45 kW	>5 Hz
55 kW - 355 kW	>3-4 Hz

115 Slip compensation (SLIP COMPENSAT.)

Value:

-500 - 500 %

★ 100 %

Function:

Slip compensation is calculated automatically, i.e. on the basis of the rated motor speed $n_{M,N}$.

In parameter 115, slip compensation can be adjusted in detail, which compensates for tolerances in the value of $n_{M,N}$.

This function is not active together with *Variable torque* (parameter 101 - variable torque graphs), *Torque control*, *Speed feedback* and *Special motor characteristics*.

Description of choice:

Enter a %-value of the rated motor frequency (parameter 104).

116 Slip compensation time constant (SLIP TIME CONST.)

Value:

0.05 - 5.00 sec.

★ 0.50 sec.

Function:

This parameter determines the slip compensation reaction speed.

Description of choice:

A high value results in slow reaction. Conversely, a low value results in quick reaction.

If low-frequency resonance problems are encountered, the time set must be longer.

117 Resonance dampening (RESONANCE DAMP.)

Value:

0 - 500 %

★ 100 %

Function:

High-frequency resonance problems can be eliminated by setting parameters 117 and 118.

Description of choice:

For less resonance oscillation, the value of parameter 118 must be increased.

118 Resonance dampening time constant (DAMP.TIME CONST.)

Value:

5 - 50 ms

★ 5 ms

Function:

High-frequency resonance problems can be eliminated by setting parameters 117 and 118.

Description of choice:

Choose the time constant that provides the best dampening.

119 High starting torque (HIGH START TORQ.)

Value:

0.0 - 0.5 sec.

★ 0.0 sec.

Function:

In order to secure a high starting torque, approx. 2 x $I_{VLT,N}$ for max. 0.5 sec. is allowed. However, the current is limited by the protection limit of the frequency converter (inverter).

Description of choice:

Set the necessary time in which a high starting torque is desired.

120 Start delay (START DELAY)

Value:

0.0 - 10.0 sec.

★ 0.0 sec.

Function:

This parameter enables a delay of the starting time. The frequency converter begins with the start function selected in parameter 121.

Description of choice:

Set the desired time until acceleration is to begin.

121 Start function (START FUNCTION)

Value:

DC hold in start delay time (DC HOLD/DELAY TIME)	[0]
DC brake in start delay time (DC BRAKE/DELAY TIME)	[1]
★ Coasting in start delay time (COAST/DELAY TIME)	[2]
Start frequency/voltage clockwise. (CLOCKWISE OPERATION)	[3]
Start frequency/voltage in reference direction (HORIZONTAL OPERATION)	[4]
VVC ^{plus} clockwise (VVC+ CLOCKWISE)	[5]

Function:

This is where the desired state during start delay (parameter 120) is selected.

Description of choice:

Select *DC hold in the start delay time* [0] so as to energize the motor with a DC holding current (parameter 124) in the start delay time.

Select *DC brake in the start delay time* [1] so as to energize the motor with a DC braking current (parameter 125) in the start delay time.

Select *Coasting in the start delay time* [2] and the motor will not be controlled by the frequency converter during the start delay time (inverter off).

Start frequency/voltage clockwise [3] and *VVC^{plus} clockwise* [5] is typically used in hoisting applications. *Start frequency/voltage in reference direction* [4] is used especially in applications with counterweight.

Select *Start frequency/voltage clockwise* [3] so as to have the function described in parameter 130 and 131 in the start delay time.

The output frequency will equal the setting of the start frequency in parameter 130, and the output voltage will equal the setting of the start voltage in parameter 131. Regardless of the value assumed by the reference signal, the output frequency will equal the setting of the

start frequency in parameter 130 and the output voltage will correspond to the setting of the start voltage in parameter 131.

This functionality is used typically in hoisting applications.

This is used especially in applications with a cone armature motor, where the start is to be clockwise, followed by rotation in the reference direction.

Select *Start frequency/voltage in reference direction* [4] in order to obtain the function described in parameters 130 and 131 during the start delay time. The motor will always rotate in the reference direction.

If the reference signal equals zero (0) parameter 130 *Start frequency* will be ignored and the output frequency will equal zero (0). The output voltage will correspond to the setting of the start voltage in parameter 131 *Start voltage*.

Select *VVC^{plus} clockwise* [5] so as to have only the function described in parameter 130 *Start frequency* in the start delay time. The start voltage will be calculated automatic. Notice that this function only uses the start frequency in the start delay time.

Regardless of the value assumed by the reference signal, the output frequency will equal the setting of the start frequency in parameter 130.

122 Function at stop

(FUNCTION AT STOP)

Value:

★ Coasting (COAST)	[0]
DC hold (DC-HOLD)	[1]
Motor check (MOTOR CHECK)	[2]
Pre-magnetizing (PREMAGNETIZING)	[3]

Function:

Here it is possible to select the function of the frequency converter after a stop command or when the frequency has been ramped down to 0 Hz. See parameter 123 with respect to activation of this parameter regardless of whether the stop command is active.

Description of choice:

Select *Coasting* [0] if the frequency converter is to 'let go' of the motor (inverter closed).

Select *DC hold* [1] when a DC holding current set in parameter 124 is to be activated.

Select *Motor check* [2] if the frequency converter is to check whether or not a motor has been connected.

Select *Pre-magnetizing* [3]. The magnetic field is built up in the motor while it remains stopped. This ensures that the motor can produce torque as quickly as possible on starting.

123 Min. frequency for activating function at stop (MIN.F. FUNC.STOP)

Value:

0.0 - 10.0 Hz ★ 0.0 Hz

Function:

This parameter sets the frequency at which the function selected in parameter 122 is to be activated.

Description of choice:

Enter the desired frequency.



NB!

If parameter 123 is set higher than parameter 130, the start delay function (parameters 120 and 121) will be skipped.



NB!

If parameter 123 is set too high, and DC hold has been chosen in parameter 122, the output frequency will jump to the value in parameter 123 without ramping up. This may cause an overcurrent warning/alarm.

124 DC holding current (DC-HOLD CURRENT)

Value:

(OFF) - $\frac{I_{VLT, N}}{I_{M, N}} \times 100\%$ ★ 50 %

Function:

This parameter is used to uphold the motor function (holding torque) or to pre-heat the motor.



NB!

The maximum value depends on the rated motor current. If the DC holding current is active, the frequency converter has a switching frequency of 4 kHz.

Description of choice:

This parameter can only be used if *DC hold* [1] has been selected in parameter 121 or 122. Set it as a percentage value in relation to the rated motor current $I_{M,N}$ set in parameter 105.

100% DC holding current corresponds to $I_{M,N}$.



Warning: 100 % supply for too long may damage the motor.

VLT 5122-5552, 380-500 V and VLT 5042-5602, 525-690 V work with a reduced DC current rated as 80% of $I_{VLT,N}$ at 110% overload.

125 DC braking current

(DC BRAKE CURRENT)

Value:

0 (OFF) - $\frac{I_{VLT, N}}{I_{M, N}} \times 100[\%]$ ★ 50 %

Function:

This parameter is used for setting the DC brake current that is activated upon a stop when the DC brake frequency set in parameter 127 has been reached, or if the DC brake inverse is active via digital terminal 27 or via a serial communication port. The DC braking current will be active for the duration of the DC braking time set in parameter 126.



NB!

The maximum value depends on the rated motor current. If the DC braking current is active, the frequency converter has a switching frequency of 4.5 kHz.

Description of choice:

To be set as a percentage value of the rated motor current $I_{M,N}$ set in parameter 105.

100% DC braking current corresponds to $I_{M,N}$.



Warning: 100 % supply for too long may damage the motor.

VLT 5122-5552, 380-500 V and VLT 5042-5602, 525-690 V work with a reduced DC current rated as 80% of $I_{VLT,N}$ at 110% overload.

126 DC braking time

(DC BRAKING TIME)

Value:

0.0 (OFF) - 60.0 sec. ★ 10.0 sec.

Function:

This parameter is for setting the DC braking time for which the DC braking current (parameter 125) is to be active.

Description of choice:

Set the desired time.

127 DC brake cut-in frequency (DC BRAKE CUT-IN)

Value:

0.0 - parameter 202 ☆ 0.0 Hz (OFF)

Function:

This parameter is for setting the DC brake cut-in frequency at which the DC braking current (parameter 125) is to be active, in connection with a stop command.

Description of choice:

Set the desired frequency.

128 Motor thermal protection (MOT.THERM PROTEC)

Value:

- ☆ No protection (NO PROTECTION) [0]
- Thermistor warning (THERMISTOR WARN) [1]
- Thermistor trip (THERMISTOR TRIP) [2]
- ETR Warning 1 (ETR WARNING1) [3]
- ETR Trip 1 (ETR TRIP1) [4]
- ETR Warning 2 (ETR WARNING2) [5]
- ETR Trip 2 (ETR TRIP2) [6]
- ETR Warning 3 (ETR WARNING3) [7]
- ETR Trip 3 (ETR TRIP3) [8]
- ETR Warning 4 (ETR WARNING 4) [9]
- ETR Trip 4 (ETR TRIP4) [10]

Function:

The frequency converter is able to monitor the motor temperature in two different ways:

- Via a thermistor sensor connected to one of the analogue inputs, terminals 53 and 54 (parameters 308 and 311).
- Calculation of the thermal load, based on the current load and the time. This is compared

with the rated motor current $I_{M,N}$ and the rated motor frequency $f_{M,N}$. The calculations made take into account the need for a lower load at lower speeds because of less cooling from the fan.

ETR functions 1-4 do not start calculating the load until there is a switch-over to the Setup in which they were selected. This enables the use of the ETR function, even where two or several motors alternate. For the North American market: The ETR functions provide class 10 or 20 motor overload protection in accordance with NEC.

Description of choice:

Select *No protection* if no warning or tripping is required when the motor is overloaded.

Select *Thermistor warning* if a warning is desired when the connected thermistor - and thus the motor - gets too hot.

Select *Thermistor trip* if cutting out (trip) is desired when the connected thermistor - and thus the motor - overheats.

Select *ETR Warning 1-4*, if a warning is to come up on the display when the motor is overloaded according to the calculations.

Select *ETR Trip 1-4* if tripping is desired when the motor is overloaded according to the calculations.

The frequency converter can also be programmed to give off a warning signal via one of the digital outputs, in which case the signal is given both for warning and for trip (thermal warning).

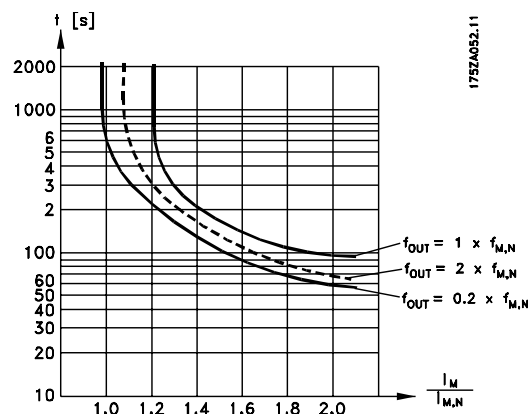

129 External motor fan

(MOTOR EXTERN FAN)

Value:

- ☆ No (NO) [0]

☆ = factory setting, () = display text, [] = value for use in communication via serial communication port

Yes (YES)

[1]

Function:

This parameter informs the frequency converter whether the motor has an external separately supplied fan (external ventilation), indicating that derating at low speed is unnecessary.

Description of choice:

If Yes [1] is selected, the graph below is followed if the motor frequency is lower. If the motor frequency is higher, the time will still derate as if no fan had been installed.

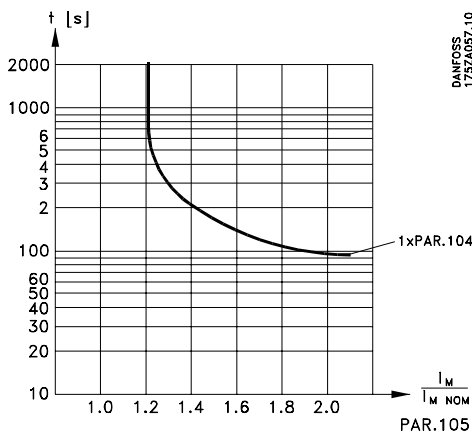

130 Start frequency (START FREQUENCY)

Value:

0.0 - 10.0 Hz

★ 0.0 Hz

Function:

This parameter allows setting of the output frequency at which the motor is to start.

The output frequency 'leaps' to the set value. This parameter can be used e.g. for hoist applications (cone rotor motors).

Description of choice:

Set the desired start frequency.

It is assumed that the start function in parameter 121 has been set to [3] or [4] and that a start delay time has been set in parameter 120; also, a reference signal must be present.



NB!

If parameter 123 is set higher than parameter 130, the start delay function (parameters 120 and 121) will be skipped.

131 Initial voltage (INITIAL VOLTAGE)

Value:

0.0 - parameter 103

★ 0.0 Volt

Function:

Some motors, such as cone rotor motors, need extra voltage/starting frequency (boost) when starting, so as to disengage the mechanical brake.

For this purpose use parameters 130/131.

Description of choice:

Set the desired value required to disengage the mechanical brake.

It is assumed that the start function in parameter 121 has been set to [3] or [4] and that a start delay time has been set in parameter 120; also, a reference signal must be present.

145 Minimum DC brake time (DC BRK MIN. TIME)

Value:

0 - 10 sec.

★ 0 sec.

Function:

If a minimum DC brake time is necessary before a new start is possible, this parameter can be set.

Description of choice:

Select the desired time.

Parameters - References and limits

200 Output frequency range/direction (OUT FREQ RNG/ROT)

Value:

- ★ Only clockwise, 0-132 Hz (132 Hz CLOCK WISE) [0]
- Both directions, 0-132 Hz (132 Hz BOTH DIRECT.) [1]
- Only clockwise, 0-1000 Hz (1000 Hz CLOCK WISE) [2]
- Both directions, 0-1000 Hz (1000 Hz BOTH DIRECT.) [3]
- Only counter clockwise, 0-132 Hz (132 Hz COUNTERCLOCK) [4]
- Only counter clockwise, 0-1000 Hz (1000 Hz COUNTERCLOCK) [5]

Function:

This parameter guarantees protection against unwanted reversing. Furthermore, the maximum output frequency can be selected that is to apply, regardless of the settings of other parameters.



NB!

The output frequency of the frequency converter can never assume a value higher than 1/10 of the switching frequency, see parameter 411.

Is not to be used together with *Process control, closed loop* (parameter 100).

Description of choice:

Select the desired direction as well as output frequency.

Note that if *Clockwise, 0-132 Hz* [0], *Clockwise, 0-1000 Hz* [2], *Counter clockwise, 0-132 Hz* [4] or *Counter clockwise, 0-1000 Hz* [5] is selected, the output frequency will be limited to the range $f_{MIN} - f_{MAX}$.

If *Both directions, 0-132 Hz* [1] or *Both directions, 0-1000 Hz* [3] is selected, the output frequency will be limited to the range $\pm f_{MAX}$ (the minimum frequency is of no significance).

Example:

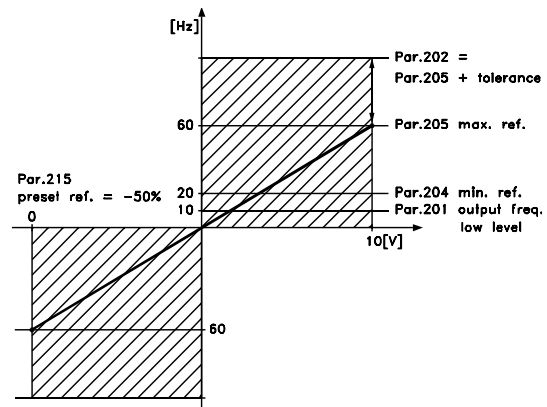

175ZA294.11

Parameter 200 Output frequency range/direction = both directions.

201 Output frequency low limit (F_{MIN}) (OUT FREQ LOW LIM)

Value:

0.0 - f_{MAX} ★ 0.0 Hz

Function:

In this parameter, a minimum motor frequency limit can be selected that corresponds to the minimum frequency at which the motor is to run.

The minimum frequency can never be higher than the maximum frequency, f_{MAX} .

If *Both directions* has been selected in parameter 200, the minimum frequency is of no significance.

Description of choice:

A value from 0.0 Hz to the max. frequency selected in parameter 202 (f_{MAX}) can be chosen.

202 Output frequency high limit (F_{MAX}) (OUT FREQ HI LIM)

Value:

$f_{MIN} - 132/1000$ Hz (parameter 200) ★ depends on unit

Function:

In this parameter, a maximum motor frequency can be selected that corresponds to the highest frequency at which the motor is to run. The factory setting is 132 Hz for VLT 5001-5027 200-240V; VLT 5001-5102 380-500 V; and VLT 5001-5062 525-600 V.

For VLT 5032-5052 200-240 V; VLT 5122-5552 380-500 V; and 5042-5602 525-690 V the factory setting is 66 Hz.

See also parameter 205.



NB!

The output frequency of the frequency converter can never assume a value higher than 1/10 of the switching frequency.

Description of choice:

A value from f_{MIN} to the choice made in parameter 200 can be selected.



NB!

If the maximum motor frequency is set at more than 500 Hz, parameter 446 must be set at 60° *AVM* [0] switching pattern.

203	Reference/feedback area (REF/FEEDB. RANGE)
Value:	
★ Min - Max (MIN - MAX)	[0]
- Max - + Max (-MAX+MAX)	[1]

Function:

This parameter decides whether the reference signal and the feedback signal are to be positive or can be both positive and negative.

The minimum limit may be a negative value, unless *Speed control, closed loop* has been selected (parameter 100).

Choose *Min - Max* [0] if *Process control, closed loop* has been selected in parameter 100.

Description of choice:

Choose the desired range.

204	Minimum reference (MIN. REFERENCE)
Value:	
-100,000.000 - Ref _{MAX}	★ 0.000
Depends on parameter 100.	

Function:

The *Minimum reference* gives the minimum value that can be assumed by the sum of all references. *Minimum reference* is only active if *Min - Max* [0] has been set in parameter 203; however, it is always active in *Process control, closed loop* (parameter 100).

Description of choice:

Is only active when parameter 203 has been set to *Min - Max* [0].

Set the desired value.

The unit follows the choice of configuration in parameter 100.

Speed control, open loop:	Hz
Speed control, closed loop:	rpm
Torque control, open loop:	Nm
Torque control, speed feedback:	Nm
Process control, closed loop:	Process units (par. 416)

Special motor characteristics, activated in parameter 101, use the unit selected in parameter 100.

205	Maximum reference (MAX. REFERENCE)
Value:	
Ref _{MIN} - 100,000.000	★ 50.000

Function:

The *Maximum reference* gives the highest value that can be assumed by the sum of all references. If closed loop has been selected in parameter 100, the maximum reference cannot be set higher than the maximum feedback (parameter 415).

Description of choice:

Set the desired value.

The unit follows the choice of configuration in parameter 100.

Speed control, open loop:	Hz
Speed control, closed loop:	rpm
Torque control, open loop:	Nm
Torque control, speed feedback:	Nm
Process control, closed loop:	Process units (par. 416)

Special motor characteristics, activated in parameter 101, use the unit selected in parameter 100.

206	Ramp type (RAMP TYPE)
Value:	
★ Linear (LINEAR)	[0]
Sinusoidal (S1)	[1]
Sin ² (S2)	[2]
Sin ³ (S3)	[3]
Sin ² filter (S2 FILTER)	[4]

Function:

There is a choice of 4 different ramp types.

Description of choice:

Select the desired ramp type, depending on requirements concerning acceleration/deceleration. The ramp is recalculated if the reference is changed during ramping, resulting in an increase of the ramping time. Selection S² filter [4] is not recalculated if the reference is changed during ramping.

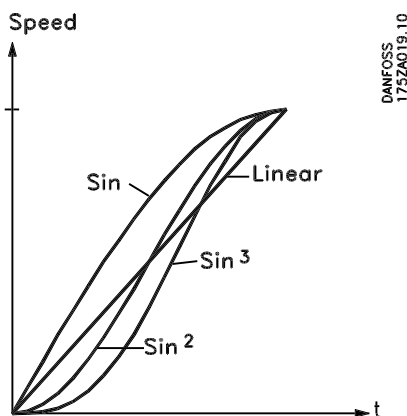

207 Ramp-up time 1

(RAMP UP TIME 1)

Value:

0.05 - 3600 sec. ☆ depends on unit

Function:

The ramp-up time is the acceleration time from 0 Hz to the rated motor frequency $f_{M,N}$ (parameter 104) or the rated motor speed $n_{M,N}$ (if *Speed control, closed loop* has been selected in parameter 100). This presupposes that the output current does not reach the torque limit (to be set in parameter 221).

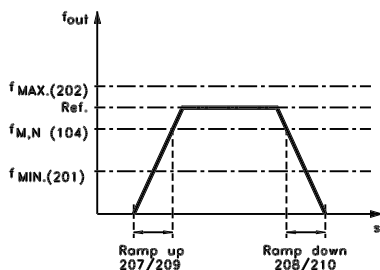

175ZA047.12

Description of choice:

Program the desired ramp-up time.

208 Ramp-down time 1

(RAMP DOWN TIME 1)

Value:

0.05 - 3600 sec. ☆ depends on unit

Function:

The ramp-down time is the deceleration time from the rated motor frequency $f_{M,N}$ (parameter 104) to 0 Hz or from the rated motor speed $n_{M,N}$, provided there is no over-voltage in the inverter because of regenerative operation of the motor, or if the generated current reaches the torque limit (to be set in parameter 222).

Description of choice:

Program the desired ramp-down time.

209 Ramp-up time 2

(RAMP UP TIME 2)

Value:

0.05 - 3600 sec. ☆ depends on unit

Function:

See description of parameter 207.

Description of choice:

Program the desired ramp-up time. Switching from ramp 1 to ramp 2 is effected via a signal on digital input terminal 16, 17, 29, 32 or 33.

210 Ramp-down time 2

(RAMP DOWN TIME 2)

Value:

0.05 - 3600 sec. ☆ depends on unit

Function:

See description of parameter 208.

Description of choice:

Program the desired ramp-down time. Switching from ramp 1 to ramp 2 is effected via a signal on digital input terminal 16, 17, 29, 32 or 33.

211 Jog ramp time (JOG RAMP TIME)

Value:

0.05 - 3600 sec. ☆ depends on unit

Function:

The jog ramp time is the acceleration/deceleration time from 0 Hz to the rated motor frequency $f_{M,N}$ (pa-

parameter 104). It is assumed that the output current is not higher than the torque limit (set in parameter 221).

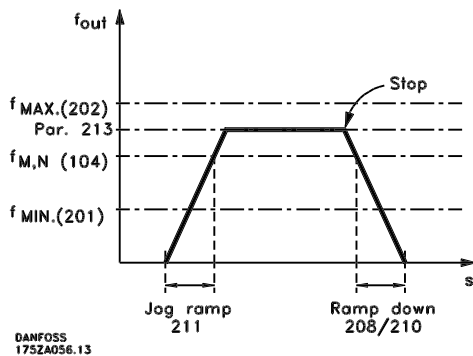

The jog ramp time starts if a jog signal is given via the control panel, the digital inputs or the serial communication port.

Description of choice:

Set the desired ramp time.

212 Quick stop ramp-down time

(Q STOP RAMP TIME)

Value:

0.05 - 3600 sec. ☆ depends on unit

Function:

The ramp-down time is the deceleration time from the rated motor frequency to 0 Hz, provided no over-voltage arises in the inverter because of generating operation of the motor or if the generated current becomes higher than the torque limit (set in parameter 222). Quick-stop is activated by means of a signal on digital input terminal 27, or via the serial communication port.

Description of choice:

Program the desired ramp-down time.

213 Jog frequency (JOG FREQUENCY)

Value:

0.0 - parameter 202 ☆ 10.0 Hz

Function:

The jog frequency f_{JOG} is the fixed output frequency at which the frequency converter is running when the jog function is activated.

Description of choice:

Set the desired frequency.

214 Reference function

(REF FUNCTION)

Value:

- ☆ Sum. (SUM) [0]
- Relative (RELATIVE) [1]
- External/preset (EXTERNAL/PRESET) [2]

Function:

It is possible to define how the preset references are to be added to the other references. For this purpose, *Sum* or *Relative* is used. It is also possible - by using the *External/preset* function - to select whether a shift between external references and preset references is desired.

Description of choice:

If *Sum* [0] is selected, one of the adjusted preset references (parameters 215-218) is added as a percentage of the maximum possible reference.

If *Relative* [1] is selected, one of the adjusted preset references (parameters 215-218) is added to the external references as a percentage of the actual reference.

In addition, it is possible to use parameter 308 to select whether the signals on terminals 54 and 60 are to be added to the sum of the active references.

If *External/preset* [2] is selected, it is possible to shift between external references or preset references via terminal 16, 17, 29, 32 or 33 (parameter 300, 301, 305, 306 or 307). Preset references will be a percentage value of the reference range.

External reference is the sum of the analogue references, pulses and bus references. See also drawings in section *Handling of multi-references*.



NB!

If *Sum* or *Relative* is selected, one of the preset references will always be active. If the preset references are to be without influence, they should be set to 0% (as in the factory setting).

The example shows how to calculate the output frequency if using *Preset references* together with *Sum* and *Relative* in parameter 214.

Parameter 205 *Maximum reference* has been set to 50 Hz.

Par. 204 Min. reference	Increase [Hz/V]	Frequency by 4.0 V	Par. 215 Preset ref.	Par. 214 Reference type = Sum [0]	Par. 214 Reference type = Relative [1]
1) 0	5	20 Hz	15 %	Output frequency 00+20+7.5 = 27.5 Hz	Output frequency 00+20+3 = 23.0 Hz
2) 10	4	16 Hz	15 %	10+16+6.0 = 32.0 Hz	10+16+2.4 = 28.4 Hz
3) 20	3	12 Hz	15 %	20+12+4.5 = 36.5 Hz	20+12+1.8 = 33.8 Hz
4) 30	2	8 Hz	15 %	30+8+3.0 = 41.0 Hz	30+8+1.2 = 39.2 Hz
5) 40	1	4 Hz	15 %	40+4+1.5 = 45.5 Hz	40+4+0.6 = 44.6 Hz

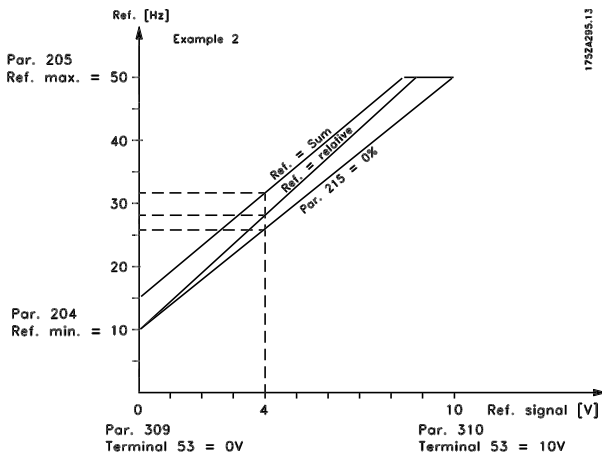

Terminals 17/29/33 preset ref. msb	Terminals 16/29/32 preset ref. lsb	
0	0	Preset ref. 1
0	1	Preset ref. 2
1	0	Preset ref. 3
1	1	Preset ref. 4

See drawings in section *Handling of multi-references*.

215 Preset reference 1 (PRESET REF. 1)

216 Preset reference 2 (PRESET REF. 2)

217 Preset reference 3 (PRESET REF. 3)

218 Preset reference 4 (PRESET REF. 4)

Value:

-100.00 % - +100.00 % ☆ 0.00%

of the reference range/external reference

Function:

Four different preset references can be programmed in parameters 215-218.

The preset reference is stated as a percentage of the value Ref_{MAX} or as a percentage of the other external references, depending on the choice made in parameter 214. If a $Ref_{MIN} \neq 0$ has been programmed, the preset reference as a percentage will be calculated on the basis of the difference between Ref_{MAX} and Ref_{MIN} , following which the value is added to Ref_{MIN} .

Description of choice:

Set the fixed reference(s) that is/are to be the options.

To use the fixed references, it is necessary to have selected Preset ref. enable on terminal 16, 17, 29, 32 or 33.

Choices between fixed references can be made by activating terminal 16, 17, 29, 32 or 33 - see the table below.

219 Catch up/slow downvalue

(CATCH UP/SLW DWN)

Value:

0.00-100% of the current reference ☆ 0.00%

Function:

This parameter enables the entry of a percentage value (relative) which will either be added to or deducted from the actual reference.

Description of choice:

If Catch up has been selected via one of the terminals 16, 29 or 32 (parameters 300, 305 and 306), the percentage (relative) value selected in parameter 219 will be added to the total reference.

If Slow down has been selected via one of the terminals 17, 29 or 33 (parameters 301, 305 and 307), the percentage (relative) value selected in parameter 219 will be deducted from the total reference.

221 Torque limit for motor mode

(TORQ LIMIT MOTOR)

Value:

0.0 % - xxx.x % of $T_{M,N}$ ☆ 160 % of $T_{M,N}$

Function:

This function is relevant for all application configurations; speed, process and torque control.

This is where to set the torque limit for motor operation. The torque limiter is active in the frequency range up to the rated motor frequency (parameter 104). In the oversynchronous range, where the frequency is higher than the rated motor frequency, this function acts as a current limiter. See fig. below.

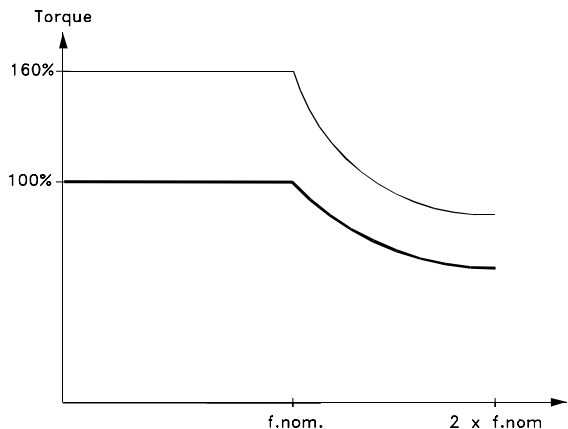

DANFOSS 175FA234-1C

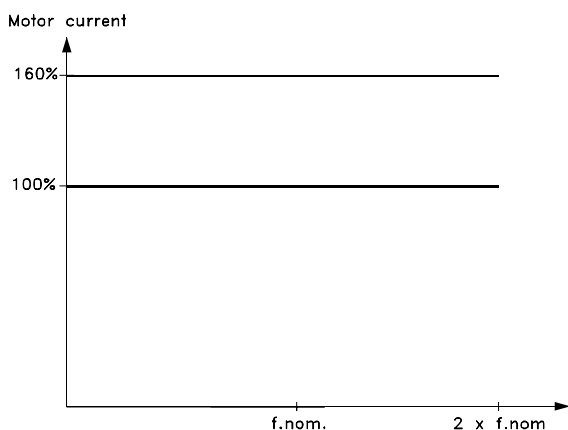

DANFOSS 175FA234-1C

Description of choice:

See also parameter 409 for further details.

In order to protect the motor from reaching pull-out torque, the factory setting is 1.6 x the rated motor torque (calculated value).

If a synchronous motor is used, the torque limit must be increased in relation to the factory setting.

If a setting in parameters 101-106 is changed, parameters 221/222 are not automatically reversed to the factory setting.

222 Torque limit for generating operation

(TORQ LIMIT GENER)

Value:

0.0 % - xxx.x % of $T_{M,N}$ ★ 160 %

The max. torque depends on the unit and the motor size selected.

Function:

This function is relevant for all application configurations; speed, process and torque control.

This is where to set the torque limit for generating operation. The torque limiter is active in the frequency range up to the rated motor frequency (parameter 104).

In the oversynchronous range, where the frequency is higher than the rated motor frequency, this function acts as a current limiter.

See fig. for parameter 221 as well as parameter 409 for further details.

Description of choice:

If *Resistor brake* [1] has been selected in parameter 400, the torque limit is changed to 1.6 x the rated motor torque.

223 Warning: Low current

(WARN. CURRENT LO)

Value:

0.0 - parameter 224 ★ 0.2 A

Function:

When the motor current is below the limit, I_{LOW} , programmed in this parameter, the display indicates CURRENT LOW.

The signal outputs can be programmed to transmit a status signal via terminal 42 or 45 as well as via relay output 01 or 04 (parameter 319, 321, 323 or 326).

Description of choice:

The lower signal limit I_{LOW} of the motor current must be programmed within the normal working range of the frequency converter.

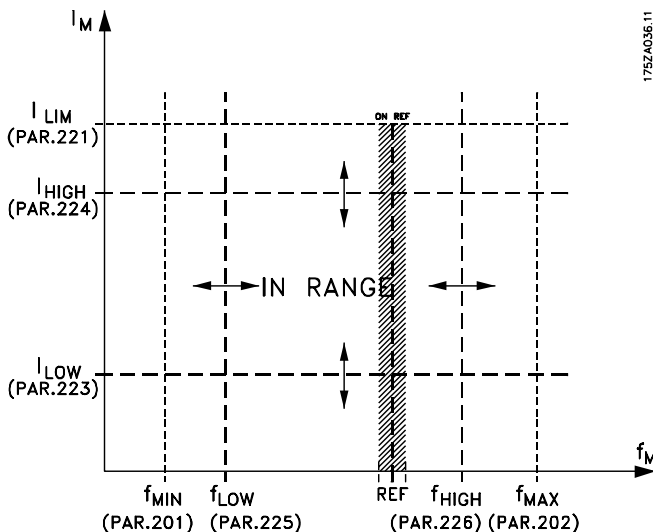

224 Warning: High current
(WARN. CURRENT HI)

Value:

Parameter 223 - $I_{VLT,MAX}$ ☆ $I_{VLT,MAX}$

Function:

If the motor current gets above the limit programmed in this parameter, I_{HIGH} , the display will indicate CURRENT HIGH.

The signal outputs can be programmed to transmit a status signal via terminal 42 or 45 and via relay output 01 or 04 (parameter 319, 321, 323 or 326).

Description of choice:

The upper signal limit of the motor current, I_{HIGH} , must be programmed within the normal working range of the frequency converter. See drawing at parameter 223.

225 Warning: Low frequency
(WARN. FREQ. LOW)

Value:

0.0 - parameter 226 ☆ 0.0 Hz

Function:

When the motor frequency is below the limit programmed in this parameter, f_{LOW} , the display indicates FREQUENCY LOW.

The signal outputs can be programmed to transmit a status signal via terminal 42 or 45 and via relay output 01 or 04 (parameter 319, 321, 323 or 326).

Description of choice:

The lower signal limit of the motor frequency, f_{LOW} , is to be programmed within the normal working range of the frequency converter.

See drawing at parameter 223.

226 Warning: High frequency
(WARN. FREQ. HIGH)

Value:

parameter 225 - parameter 202 ☆ 132.0 Hz

Function:

When the motor frequency is above the limit programmed in this parameter, f_{HIGH} , the display will indicate FREQUENCY HIGH.

The signal outputs can be programmed to transmit a status signal via terminal 42 or 45 and via relay output 01 or 04 (parameter 319, 321, 323 or 326).

Description of choice:

The upper signal limit of the motor frequency, f_{HIGH} , must be programmed within the normal working range of the frequency converter.

See drawing at parameter 223.

227 Warning: Low feedback
(WARN. FEEDB. LOW)

Value:

-100,000.000 - parameter 228. ☆ -4000.000

Function:

If the connected feedback signal gets below the value set in this parameter, the signal outputs can be programmed to transmit a status signal via terminal 42 or 45 and via relay output 01 or 04 (parameter 319, 321, 323 or 326).

Description of choice:

Set the desired value.

228 Warning: High feedback
(WARN. FEEDB HIGH)

Value:

parameter 227 - 100,000.000 ☆ 4000.000

☆ = factory setting, () = display text, [] = value for use in communication via serial communication port

Function:

If the connected feedback signal gets above the value set in this parameter, the signal outputs can be programmed to transmit a status signal via terminal 42 or 45 and via relay output 01 or 04 (parameter 319, 321, 323 or 326).

Description of choice:

Set the desired value.

229 Frequency bypass, bandwidth

(FREQ BYPASS B.W.)

Value:

0 (OFF) - 100% ★ 0 (OFF) %

Function:

Some systems call for some output frequencies to be avoided because of resonance problems in the system.

In parameters 230-233 these output frequencies can be programmed for bypassing (Frequency bypass). In this parameter (229), a bandwidth can be defined on either side of these frequency bypasses.

The frequency bypass function is not active if par. 002 is set to *Local* and par. 013 is set to *LCP ctrl/Open loop* or *LCP+dig ctrl/Open loop*.

Description of choice:

The bypass bandwidth is set as a percentage of the bypass frequency which is selected in parameter 230-233.

The bypass bandwidth indicates max. variation of the bypass frequency.

Example: A bypass frequency of 100 Hz and a bypass bandwidth of 1% are selected. In this case the bypass frequency can vary between 99.5 Hz and 100.5 Hz i.e. 1% of 100 Hz.

230 Frequency bypass 1 (FREQ. BYPASS 1)

231 Frequency bypass 2 (FREQ. BYPASS 2)

232 Frequency bypass 3 (FREQ. BYPASS 3)

233 Frequency bypass 4 (FREQ. BYPASS 4)

Value:

0.0 - parameter 200 ★ 0.0 Hz

Function:

Some systems call for some output frequencies to be avoided because of resonance problems in the system.

Description of choice:

Enter the frequencies to be avoided.

See also parameter 229.

234 Motor phase monitor

(MOTOR PHASE MON)

Value:

★ Enable (ENABLE) [0]
Disable (DISABLE) [1]

Function:

In this parameter it is possible to select monitoring of the motor phases.

Description of choice:

If *Enable* is selected, the frequency converter will react on a missing motor phase which will result in alarm 30, 31 or 32.

If *Disable* is selected, **no** alarm is given if a motor phase is missing. The motor can be damaged/overheated if it runs on only two phases. It is therefore recommended to keep the missing motor phase function ENABLED.

■ Parameters - Inputs and outputs

Digital inputs	Terminal no. parameter	16 300	17 301	18 302	19 303	27 304	29 305	32 306	33 307
Value:									
No function	(NO OPERATION)	[0]	[0]	[0]	[0]		[0]	[0]	[0]
Reset	(RESET)	[1]*	[1]				[1]	[1]	[1]
Coasting stop, inverse	(COAST INVERSE)						[0]*		
Reset and coasting stop, inverse	(COAST & RESET INVERS)					[1]			
Quick-stop, inverse	(QSTOP INVERSE)					[2]			
DC-braking, inverse	(DCBRAKE INVERSE)					[3]			
Stop inverse	(STOP INVERSE)	[2]	[2]			[4]	[2]	[2]	[2]
Start	(START)				[1]*				
Latched start	(LATCHED START)			[2]					
Reversing	(REVERSING)					[1]*			
Start reversing	(START REVERSE)				[2]				
Only start clockwise, on	(ENABLE START FWD.)	[3]		[3]			[3]	[3]	
Only start anti-clockwise, on	(ENABLE START REV)		[3]		[3]		[4]		[3]
Jog	(JOGGING)	[4]	[4]				[5]*	[4]	[4]
Preset reference, on	(PRESET REF. ON)	[5]	[5]				[5]	[5]	[5]
Preset reference, lsb	(PRESET REF. SEL. LSB)	[5]					[7]	[6]	
Preset reference, msb	(PRESET REF. MSB)		[6]				[8]		[6]
Freeze reference	(FREEZE REFERENCE)	[7]	[7]*				[9]	[7]	[7]
Freeze output	(FREEZE OUTPUT)	[8]	[8]				[10]	[8]	[8]
Speed up	(SPEED UP)	[9]					[11]	[9]	
Speed down	(SPEED DOWN)		[9]				[12]		[9]
Choice of Setup, lsb	(SETUP SELECT LSB)	[10]					[13]	[10]	
Choice of Setup, msb	(SETUP SELECT MSB)		[10]				[14]		[10]
Choice of Setup, msb/speed up	(SETUP MSB/SPEED UP)							[11]	
								*	
Choice of Setup, lsb/speed down	(SETUP LSB/SPEED DOWN)								[11]
									*
Catch-up	(CATCH UP)	[11]					[15]	[12]	
Slow-down	(SLOW DOWN)		[11]				[16]		[12]
Ramp 2	(RAMP 2)	[12]	[12]				[17]	[13]	[13]
Mains failure inverted	(MAINS FAILURE INVERSE)	[13]	[13]				[18]	[14]	[14]
Pulse reference	(PULSE REFERENCE)		[23]				[28] ¹		
Pulse feedback	(PULSE FEEDBACK)								[24]
Encoder feedback input, A	(ENCODER INPUT 2A)								[25]
Encoder feedback input, B	(ENCODER INPUT 2B)							[24]	
Safety interlock	(SAFETY INTERLOCK)		[24]			[5]			
Data change lock	(PROGRAMMING LOCK)	[29]	[29]				[29]	[29]	[29]

1) If this function is selected for terminal 29, the same function for terminal 17 will not be valid, even if it has been selected to be active.

300 Terminal 16, input

(DIGITAL INPUT 16)

Function:

In this and the following parameters it is possible to choose between the different possible functions related to the inputs on terminals 16-33.

The function options are shown in the table on page 111. The maximum frequency for terminal 16, 17, 18 and 19 is 5 kHz. The maximum frequency for terminals 29, 32 and 33 is 65 kHz.

Description of choice:

No function is selected if the frequency converter is not to react to signals transmitted to the terminal.

Reset zeroes the frequency converter after an alarm; however, not all alarms can be reset.

Coasting stop inverse is used for making the frequency converter let go of the motor to make it coast freely to stop. Logic '0' leads to coasting stop and reset.

Reset and coasting stop inverse, is used for activating coasting stop at the same time as reset. Logic '0' leads to coasting stop and reset

Quick-stop **inverse** is used for stopping the motor in accordance with the quick-stop ramp (set in parameter 212). Logic '0' leads to a quick-stop.

DC braking **inverse** is used for stopping the motor by energizing it with a DC voltage for a given time, see parameters 125-127.

Please note that this function is only active if the value of parameters 126-127 is different from 0. Logic '0' leads to DC braking.

Stop **inverse** is activated by interrupting the voltage to the terminal. This means that if the terminal has no voltage, the motor cannot run. The stop will be effected in accordance with the selected ramp (parameters 207/208/209/210).



None of the above-mentioned stop commands (start-disable) are to be used as disconnection switch in connection with repairs. Cut mains instead.



NB!

It must be noted that when the frequency converter is at the torque limit and has received a stop command, it will only stop if terminal 42, 45, 01 or 04 has been connected to terminal 27. The data choice on

terminal 42, 45, 01 or 04 must be *Torque limit* and *stop* [27].

Start, is selected if a start/stop (operating command, group 2) command is desired. Logic '1' = start, logic '0' = stop.

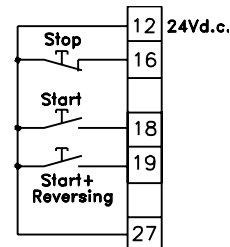

DANFOSS
175ZA082.10

Latched start - if a pulse is applied for min. 3 ms, the motor will start, provided no stop command (operating command, group 2). The motor stops if Stop inverse is activated briefly.

Reversing is used for changing the direction of rotation of the motor shaft. Logic "0" will not lead to reversing. Logic "1" will lead to reversing. The reversing signal only changes the direction of rotation; it does not activate the start function.

Reversing requires that *Both directions* has been selected in parameter 200.

Is not active if *Process control, closed loop*, *Torque control open loop* or *Torque control, speed feedback* has been selected.

Start reversing, is used for start/stop (operating command, group 2) and for reversing with the same signal. No signal is allowed on terminal 18 at the same time. Acts as latch start reversing, provided latch start has been chosen for terminal 18.

Is not active if *Process control, closed loop* has been selected.

Start clockwise only, on is used if the motor shaft is only to be able to rotate clockwise when starting. Should not be used with *Process control, closed loop*.

Start anti-clockwise only, is used if the motor shaft is to rotate anti-clockwise when started.

Should not be used with *Process control, closed loop*.

Jog is used for overriding the output frequency to the jog frequency set in parameter 213. The ramp time can be set in parameter 211. Jog is not active if a stop command has been given (start-disable). Jog overrides stop (operating command, group 2).

Preset reference, **on** is used for shifting between external reference and preset reference. It is assumed

that *External/preset* [2] has been selected in parameter 214. Logic '0' = external references active; logic '1' = one of the four preset references is active in accordance with the table below.

Preset reference, Isb and Preset reference, msb enables a choice of one of the four preset references, in accordance with the table below.

	Preset ref. msb	Preset ref. Isb
Preset ref. 1	0	0
Preset ref. 2	0	1
Preset ref. 3	1	0
Preset ref. 4	1	1

Freeze reference - freezes the actual reference. The frozen reference is now the point of enable/condition for *Speed up* and *Speed down* to be used.

If speed up/down is used, the speed change always follows ramp 2 (parameters 209/210) in the range 0 - Ref MAX.

Freeze output - freezes the actual motor frequency (Hz). The frozen motor frequency is now the point of enable/condition for *Speed up* and *Speed down* to be used.

If speed up/down is used, the speed change always follows ramp 2 (parameters 209/210) in the range 0 - f_{M,N}.



NB!

If *Freeze output* is active, the frequency converter cannot be stopped via terminals 18 and 19, but only via terminal 27 (to be programmed for *Coasting stop, inverse* [0] or *Reset and coasting stop, inverse* [1]).

After **Freeze output**, the PID integrators are reset.

Speed up and Speed down are selected if digital control of the up/down speed is desired (motor potentiometer). This function is only active if *Freeze reference* or *Freeze output* has been selected. As long as there is a logic '1' on the terminal selected for speed up, the reference or the output frequency will increase. Follow ramp 2 (parameter 209) in the range 0 - f_{MIN}.

As long as there is a logic '1' on the terminal selected for speed down, the reference or the output frequency will be reduced. Follow ramp 2 (parameter 210) in the range 0 - f_{MIN}.

Pulses (logic '1' minimum high for 3 ms and a minimum pause of 3 ms) will lead to a change of speed of 0.1% (reference) or 0.1 Hz (output frequency).

Example:

	Terminal (16)	(17)	Freeze ref./ Freeze output
No speed change	0	0	1
Speed down	0	1	1
Speed up	1	0	1
Speed down	1	1	1

The speed reference frozen via the control panel can be changed even if the frequency converter has stopped. The frozen reference will be remembered in case of a mains drop-out.

Selection of Setup, Isb and Selection of Setup, msb enables a choice of one of the four Setups; however, this presupposes that parameter 004 has been set at *Multi Setup*.

Selection of Setup, msb/Speed up and Selection of Setup, Isb/Speed down - together with the use of *Freeze reference* or *Freeze output* - enable up/down speed change.

The selection of Setup occurs in accordance with the below verification table:

	Selection of Setup (32)msb	(33)Isb	Freeze ref/ Freeze output
Setup 1	0	0	0
Setup 2	0	1	0
Setup 3	1	0	0
Setup 4	1	1	0
No speed change	0	0	1
Speed down	0	1	1
Speed up	1	0	1
Speed down	1	1	1

Catch-up/Slow-down is selected if the reference value is to be increased or reduced by a programmable percentage value set in parameter 219.

	Slow-down	Catch-up
Unchanged speed	0	0
Reduced by %-value	1	0
Increased by %-value	0	1
Reduced by %-value	1	1

Ramp 2 is selected if a change between ramp 1 (parameters 207-208) and ramp 2 (209-210) is desired. Logic '0' leads to ramp 1, while logic '1' leads to ramp 2.

Mains failure inverted is to be selected if parameter 407 *Mains failure* and/or parameter 408 *Quick discharge* is to be activated. Mains failure inverted is active in the logical '0' situation.

See also Mains fault/quick discharge on page 66, if required.



NB!

The frequency converter can be totally damaged by repeating the Quick discharge function on the digital input with mains voltage connected to the SYSTEM.

Pulse reference is selected if a pulse sequence (frequency) of 0 Hz is used, corresponding to Ref_{MIN}, parameter 204. The frequency is set in parameter 327, corresponding to Ref_{MAX}.

Pulse feedback is selected if a pulse sequence (frequency) is selected as a feedback signal.

Select Encoder feedback, input A, if encoder feedback is to be used after choosing Speed control, closed loop or Torque control, speed feedback in parameter 100. Set Pulse/rpm in parameter 329.

Select Encoder feedback, input B, if encoder feedback is to be used with a 90° pulse to register the direction of rotation.

Safety interlock has the same function as *Coasting stop, inverse*, but *Safety interlock* generates the alarm message “external fault” on the display when the selected terminal is logic “0”. The alarm message will also be active via digital outputs 42/45 and relay outputs 01/04 if programmed for *Safety interlock*. The alarm can be reset using a digital input or the [OFF/STOP] key.

Data change lock is selected if data changes to parameters are not to be made via the control unit; however, it will still be possible to carry out data changes via the bus.

301 Terminal 17, input (DIGITAL INPUT 17)

Value:

See parameter 300.

Function:

This parameter allows a choice between the different options on terminal 17.

The functions are shown in the table at the beginning of the section *Parameters - Inputs and Outputs*. Maximum frequency for terminal 17 is 5 kHz.

Description of choice:

See parameter 300.

302 Terminal 18 Start, input (DIGITAL INPUT 18)

Value:

See parameter 300.

Function:

This parameter allows a choice between the different options on terminal 18. The enabled functions are shown in the table at the beginning of the section *Parameters - Inputs and Outputs*.

Maximum frequency for terminal 18 is 5 kHz.

Description of choice:

See parameter 300.

303 Terminal 19, input (DIGITAL INPUT 19)

Value:

See parameter 300.

Function:

This parameter allows a choice between the different options on terminal 19. The functions are shown in the table at the beginning of the section *Parameters - Inputs and Outputs*.

Maximum frequency for terminal 19 is 5 kHz.

Description of choice:

See parameter 300.

304 Terminal 27, input (DIGITAL INPUT 27)

Value:

See parameter 300.

Function:

This parameter allows a choice between the different options on terminal 27.

Functions are shown in the table at the beginning of the section *Parameters - Inputs and Outputs*. Maximum frequency for terminal 27 is 5 kHz.

Description of choice:

See parameter 300.

305 Terminal 29, input (DIGITAL INPUT 29)

Value:

★ = factory setting, () = display text, [] = value for use in communication via serial communication port

See parameter 300.

Function:

This parameter allows a choice between the different options on terminal 29. The functions are shown in the table at the beginning of the section *Parameters - Inputs and Outputs*.

Maximum frequency for terminal 29 is 65 kHz.

Description of choice:

See parameter 300.

306 Terminal 32, input (DIGITAL INPUT 32)

Value:

See parameter 300.

Function:

This parameter allows a choice between the different options on terminal 32. The functions are shown in the table at the beginning of the section *Parameters - Inputs and Outputs*.

Maximum frequency for terminal 32 is 65 kHz.

Description of choice:

See parameter 300.

307 Terminal 33, input (DIGITAL INPUT 33)

Value:

See parameter 300.

Function:

This parameter allows a choice between the different options on terminal 33. The functions are shown in the table at the beginning of the section *Parameters - Inputs and Outputs*.

Maximum frequency for terminal 33 is 65 kHz.

Description of choice:

See parameter 300.

Analogue inputs	terminal no. parameter	53(voltage) 308	54(voltage) 311	60(current) 314
Value:				
No operation	(NO OPERATION)	[0]	[0] ★	[0]
Reference	(REFERENCE)	[1] ★	[1]	[1] ★
Feedback signal	(FEEDBACK)	[2]		[2]
Torque limit	(TORQUE LIMIT CTRL)	[3]	[2]	[3]
Thermistor	(THERMISTOR INPUT)	[4]	[3]	
Relative reference	(RELATIVE REFERENCE)		[4]	[4]
Max. torque frequency	(MAX. TORQUE FREQ.)		[5]	

308 Terminal 53, analog input voltage (AI [V] 53 FUNCT.)

Function:

This parameter allows a choice of the desired option on terminal 53.

Scaling of the input signal is effected in parameters 309 and 310.

Description of choice:

No operation. Is selected if the frequency converter is not to react to signals connected to the terminal.

Reference. Is selected to enable change of reference by means of an analogue reference signal.

If other inputs are connected, these are added up, taking account of their signs.

Feedback-signal. Is selected if closed loop control with an analogue signal is used.

Torque limit. Is used if the torque limit value set in parameter 221 is to be changed by means of an analogue signal.

Thermistor. Is selected if a motor-integrated thermistor (according to DIN44080/81) should stop the frequency converter in case of motor overtemperature. The cut-out value is > 3 kΩ. The thermistor is connected to terminal 50 and the actual input selected (53 or 54).



NB!

If the temperature of the motor is utilized through a thermistor via the frequency converter, the following must be noted: In case of short circuits between motor-winding and thermistor, PELV is not complied with. In order to comply with PELV, the thermistor must be utilized externally.

★ = factory setting, () = display text, [] = value for use in communication via serial communication port

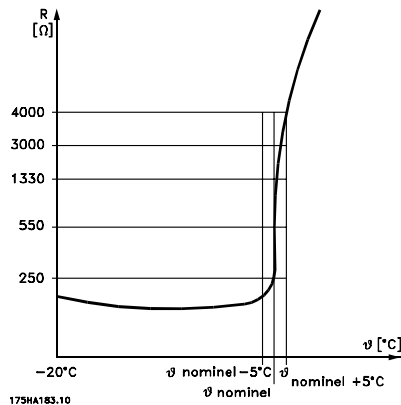

If a motor features a thermal switch instead, this can also be connected to the input. If motors run in parallel, the thermistors/thermal switches can be connected in series (total resistance < 3 kΩ). Parameter 128 must be programmed for *Thermistor warning* [1] or *Thermistor trip* [2].

Relative reference is selected if a relative adjustment of the reference sum is required.

This function is only active if *Relative* has been selected (parameter 214). The relative reference on terminal 54/60 is a percentage of the full range of the terminal in question. This will be added to the sum of the other references. If several relative references have been selected (preset reference 215-218, 311 and 314), these will be added first, following which this sum will be added to the sum of the active references.



NB!

If *Reference* or *Feedback* signal has been selected on more than one terminal, these signals will be added with signs.

Max. torque frequency. This is only used in *Torque control, open loop* (parameter 100) for limiting the output frequency. Selected if the max. output frequency is to be controlled by an analogue input signal. The frequency range goes from *Output frequency low limit* (parameter 201) to *Output frequency high limit* (parameter 202).

309 Terminal 53, min. scaling

(AI 53 SCALE LOW)

Value:

0.0 - 10.0 Volt ★ 0.0 Volt

Function:

This parameter is used for setting the signal value that corresponds to the maximum reference value set in parameter 204.

Description of choice:

Set the desired voltage value.

See also section *Handling of single references*.

310 Terminal 53, max. scaling

(AI 53 SCALE HIGH)

Value:

0.0 - 10.0 Volt ★ 10.0 Volt

Function:

This parameter is used for setting the signal value that corresponds to the maximum reference value set in parameter 205.

Description of choice:

Set the desired voltage value.

See also section *Handling of single references*.

311 Terminal 54, analogue input voltage

(AI [V] 54 FUNCT.)

Value:

See description of parameter 308

Function:

This parameter chooses between the different functions available for the input, terminal 54.

Scaling of the input signal is effected in parameters 312 and 313.

Description of choice:

See description of parameter 308.

312 Terminal 54, min. scaling

(AI 54 SCALE LOW)

Value:

0.0 - 10.0 Volt ★ 0.0 Volt

Function:

This parameter is used for setting the scaling value that corresponds to the minimum reference value set in parameter 204.

Description of choice:

Set the desired voltage value.

See also section *Handling of single references*.

313 Terminal 54, max. scaling

(AI 54 SCALE HIGH)

Value:

0.0 - 10.0 Volt ★ 10.0 Volt

Function:

This parameter is used for setting the signal value that corresponds to the maximum reference value set in parameter 205.

Description of choice:

Set the desired voltage value.
See also section *Handling of single references*.

314 Terminal 60, analogue input current

(AI [mA] 60 FUNCT)

Value:

See description of parameter 308

Function:

This parameter allows a choice between the different functions available for the input, terminal 60. Scaling of the input signal is effected in parameters 315 and 316.

Description of choice:

See description of parameter 308.

315 Terminal 60, min. scaling

(AI 60 SCALE LOW)

Value:

0.0 - 20.0 mA ★ 4 mA

Function:

This parameter determines the value of the reference signal that is to correspond to the minimum reference value set in parameter 204.

If the Time-out function of parameter 317 is used, the value must be set at >2 mA.

Description of choice:

Set the desired current value.
See also section *Handling of single references*.

316 Terminal 60, max. scaling

(AI 60 SCALE HIGH)

Value:

0.0 - 20.0 mA ★ 20.0 mA

Function:

This parameter sets the value of the reference signal that is to correspond to the maximum reference value set in parameter 205.

Description of choice:

Set the desired current value.
See also section *Handling of single references*.

317 Time out

(LIVE ZERO TIME O)

Value:

0 - 99 sec. ★ 10 sec.

Function:

If the signal value of the reference signal connected to the input, terminal 60, falls below 50% of the value set in parameter 315 for a period longer than the time set in parameter 317, the function selected in parameter 318 will be activated.

Description of choice:

Set the desired time.

318 Function after time out

(LIVE ZERO FUNCT.)

Value:

- ★ Off (OFF) [0]
- Freeze output frequency (FREEZE OUTPUT FREQ.) [1]
- Stop (STOP) [2]
- Jog (JOGGING) [3]
- Max. speed (MAX SPEED) [4]
- Stop and trip (STOP AND TRIP) [5]

Function:

This parameter allows a choice of the function to be activated if the input signal on terminal 60 drops below 2 mA, provided parameter 315 has been set higher than 2 mA and that the preset time for time-out (parameter 317) has been exceeded.

If more time-outs occur at the same time the frequency converter will give the following priority to the time-out function:

1. Parameter 318 *Function after time out*

2. Parameter 346 *Function after encoder loss*
3. Parameter 514 *Bus time interval function*

Description of choice:

The output frequency of the frequency converter can be:

- frozen at the present value
 - overruled to stop
 - overruled to jog frequency
 - overruled to max. frequency
 - overruled to stop with subsequent trip.
-

Outputs	terminal no.	42	45	01(re- lay)	04 (re- lay)
	parameter	319	321	323	326
Value:					
No function	(NO OPERATION)	[0]	[0]	[0]	[0]
Control ready	(CONTROL READY)	[1]	[1]	[1]	[1]
Ready signal	(UNIT READY)	[2]	[2]	[2]	[2]
Ready - remote control	(UNIT READY/REM CTRL)	[3]	[3]	[3]	[3] ★
Enable, no warning	(ENABLE/NO WARNING)	[4]	[4]	[4]	[4]
Running	(VLT RUNNING)	[5]	[5]	[5]	[5]
Running, no warning	(RUNNING/NO WARNING)	[6]	[6]	[6]	[6]
Running within range, no warning	(RUN IN RANGE/NO WARN)	[7]	[7]	[7]	[7]
Running at reference value, no warning	(RUN ON REF/NO WARN)	[8]	[8]	[8]	[8]
Fault	(ALARM)	[9]	[9]	[9]	[9]
Fault or warning	(ALARM OR WARNING)	[10]	[10]	[10]	[10]
Torque limit	(TORQUE LIMIT)	[11]	[11]	[11]	[11]
Out of current range	(OUT OF CURRENT RANGE)	[12]	[12]	[12]	[12]
Over I low	(ABOVE CURRENT,LOW)	[13]	[13]	[13]	[13]
Under I high	(BELOW CURRENT,HIGH)	[14]	[14]	[14]	[14]
Out of frequency range	(OUT OF FREQ RANGE)	[15]	[15]	[15]	[15]
Over f low	(ABOVE FREQUENCY LOW)	[16]	[16]	[16]	[16]
Under f high	(BELOW FREQUENCY HIGH)	[17]	[17]	[17]	[17]
Out of feedback range	(OUT OF FDBK RANGE)	[18]	[18]	[18]	[18]
Over feedback low	(ABOVE FDBK, LOW)	[19]	[19]	[19]	[19]
Under feedback high	(BELOW FDBK, HIGH)	[20]	[20]	[20]	[20]
Thermal warning	(THERMAL WARNING)	[21]	[21]	[21]	[21]
Ready - no thermal warning	(READY & NOTHERM WARN)	[22]	[22]	[22] ★	[22]
Ready - remote control - no therm. warn.	(REM RDY & NO THERMWAR)	[23]	[23]	[23]	[23]
Ready - mains voltage within range	(RDY NO OVER/UNDERVOL)	[24]	[24]	[24]	[24]
Reversing	(REVERSE)	[25]	[25]	[25]	[25]
Bus ok	(BUS OK)	[26]	[26]	[26]	[26]
Torque limit and stop	(TORQUE LIMIT AND STOP)	[27]	[27]	[27]	[27]
Brake, no brake warning	(BRAKE NO BRAKE WARNING)	[28]	[28]	[28]	[28]
Brake ready, no fault	(BRAKE RDY (NO FAULT))	[29]	[29]	[29]	[29]
Brake fault	(BRAKE FAULT (IGBT))	[30]	[30]	[30]	[30]
Relay 123	(RELAY 123)	[31]	[31]	[31]	[31]
Mechanical brake control	(MECH. BRAKE CONTROL)	[32]	[32]	[32]	[32]
Control word bit 11/12	(CTRL WORD BIT 11/12)			[33]	[33]
Extended mechanical brake control	(EXT. MECH. BRAKE)	[34]	[34]	[34]	[34]
Safety interlock	(SAFETY INTERLOCK)	[35]	[35]	[35]	[35]

★ = factory setting, () = display text, [] = value for use in communication via serial communication port

Outputs	terminal no.	42	45	01(relay)	04 (relay)
	parameter	319	321	323	326
Value:					
0-100 Hz ⇒0-20 mA	(0-100 Hz = 0-20 mA)	[36]	[36]		
0-100 Hz ⇒4-20 mA	(0-100 Hz = 4-20 mA)	[37]	[37]		
0-100 Hz ⇒0-32000 p	(0-100 Hz = 0-32000P)	[38]	[38]		
0 - f _{MAX} ⇒0-20 mA	(0-FMAX = 0-20 mA)	[39]	[39]	★	
0 - f _{MAX} ⇒4-20 mA	(0-FMAX = 4-20 mA)	[40]	[40]		
0 - f _{MAX} ⇒0-32000 p	(0-FMAX = 0-32000P)	[41]	[41]		
Ref _{MIN} - Ref _{MAX} ⇒0-20 mA	(REF MIN-MAX = 0-20 mA)	[42]	[42]		
Ref _{MIN} - Ref _{MAX} ⇒4-20 mA	(REF MIN-MAX = 4-20 mA)	[43]	[43]		
Ref _{MIN} - Ref _{MAX} ⇒0-32000 p	(REF MIN-MAX = 0-32000P)	[44]	[44]		
FB _{MIN} - FB _{MAX} ⇒0-20 mA	(FB MIN-MAX = 0-20 mA)	[45]	[45]		
FB _{MIN} - FB _{MAX} ⇒4-20 mA	(FB MIN-MAX = 4-20 mA)	[46]	[46]		
FB _{MIN} - FB _{MAX} ⇒0-32000 p	(FB MIN-MAX = 0-32000P)	[47]	[47]		
0 - I _{MAX} ⇒0-20 mA	(0-IMAX = 0-20 mA)	[48]	★	[48]	
0 - I _{MAX} ⇒4-20 mA	(0-IMAX = 4-20 mA)	[49]	[49]		
0 - I _{MAX} ⇒0-32000 p	(0-IMAX = 0-32000P)	[50]	[50]		
0 - T _{LIM} ⇒0-20 mA	(0-TLIM = 0-20 mA)	[51]	[51]		
0 - T _{LIM} ⇒4-20 mA	(0-TLIM = 4-20 mA)	[52]	[52]		
0 - T _{LIM} ⇒0-32000 p	(0-TLIM = 0-32000P)	[53]	[53]		
0 - T _{NOM} ⇒0-20 mA	(0-TNOM = 0-20 mA)	[54]	[54]		
0 - T _{NOM} ⇒4-20 mA	(0-TNOM = 4-20 mA)	[55]	[55]		
0 - T _{NOM} ⇒0-32000 p	(0-TNOM = 0-32000P)	[56]	[56]		
0 - P _{NOM} ⇒0-20 mA	(0-PNOM = 0-20 mA)	[57]	[57]		
0 - P _{NOM} ⇒4-20 mA	(0-PNOM = 4-20 mA)	[58]	[58]		
0 - P _{NOM} ⇒0-32000 p	(0-PNOM = 0-32000P)	[59]	[59]		
0 - SyncRPM ⇒0-20 mA	(0-SYNCRPM = 0-20 mA)	[60]	[60]		
0 - SyncRPM ⇒4-20 mA	(0-SYNCRPM = 4-20 mA)	[61]	[61]		
0 - SyncRPM ⇒0-32000 p	(0-0-SYNCRPM = 0-32000 p)	[62]	[62]		
0 - RPM at FMAX ⇒0-20 mA	(0-RPMFMAX = 0-20 mA)	[63]	[63]		
0 - RPM at FMAX ⇒4-20 mA	(0-RPMFMAX = 4-20 mA)	[64]	[64]		
0 - RPM at FMAX ⇒0-32000 p	(0-RPMFMAX = 0-32000 p)	[65]	[65]		

319 Terminal 42, output (AO 42 FUNCT.)

Function:

This output can act both as a digital and an analogue output. If used as a digital output (data value [0]-[65]), a 24 V DC signal is transmitted; if used as an analogue output either a 0-20 mA signal, a 4-20 mA signal or a pulse output is transmitted.

Description of choice:

Control ready, the frequency converter is ready for use; the control card receives supply voltage.

Ready signal, the frequency converter control card is receiving a supply signal and the frequency converter is ready for operation.

Ready, remote control, the frequency converter control card is receiving a supply signal and parameter 002 has been set to *remote control*.

Enable, no warning, the frequency converter is ready for use; no start or stop command has been given (start/disable). No warning.

Running is active when there is a start command or the output frequency is above 0.1 Hz. Is also active during ramp down.

Running, no warning, the output frequency is higher than the frequency set in parameter 123. A start command has been given. No warning.

Runs in range, no warning, runs within the programmed current/frequency ranges set in parameters 223-226.

Runs on reference, no warning, speed according to reference. No warning.

Fault, output is activated by alarm.

Fault or warning, the output is activated by alarm or warning.

Torque limit, the torque limit in parameter 221 has been exceeded.

★ = factory setting, () = display text, [] = value for use in communication via serial communication port

Out of current range, the motor current is outside the range programmed in parameters 223 and 224.

Over I low, the motor current is higher than set in parameter 223.

Under I high, the motor current is lower than set in parameter 224.

Out of frequency range, the output frequency is outside the frequency range programmed in parameters 225 and 226.

Over f low, the output frequency is higher than the value set in parameter 225.

Under f high, the output frequency is lower than the value set in parameter 226.

Out of feedback range, the feedback signal is outside the range programmed in parameters 227 and 228.

Over feedback low, the feedback signal is higher than the value set in parameter 227.

Under feedback high, the feedback signal is lower than the value set in parameter 228.

Thermal warning, above the temperature limit in either the motor, the frequency converter, the brake resistor or the thermistor.

Ready - no thermal warning, the frequency converter is ready for use, the control card receives supply voltage and there are no control signals on the inputs. No over-temperature.

Ready - remote control - no thermal warning, the frequency converter is ready for use and set at remote control, the control card receives supply voltage. No over-temperature.

Ready - mains voltage within range, the frequency converter is ready for use, the control card receives supply voltage and there are no control signals on the inputs. The mains voltage is within the permitted voltage range (see chapter 8).

Reversing. Logic '1' = relay activated, 24 V DC on the output when the direction of rotation of the motor is clockwise. Logic '0' = relay not activated, no signal on the output, when the direction of rotation of the motor is anti-clockwise.

Bus-ok, active communication (no time-out) via the serial communication port.

Torque limit and stop is used in connection with coasting stop (terminal 27), where it is possible to give a stop even if the frequency converter is at the torque limit. The signal is inverted, i.e. a logic '0' when the frequen-

cy converter has received a stop signal and is at the torque limit.

Brake, no brake warning, the brake is active and there are no warnings.

Brake ready, no fault, the brake is ready for operation and there are no faults.

Brake fault, the output is a logical "1" when the brake IGBT has short-circuited. This function is used to protect the frequency converter if there is a fault on the brake modules. To avoid a potential fire in the brake resistor, the output/relay can be used to cut out the supply voltage from the frequency converter.

Relay 123, if Fieldbus profile [0] has been selected in parameter 512, the relay is activated. If either OFF1, OFF2 or OFF3 (bit in the control word) is logic '1'.

Mechanical brake control, enables control of an external mechanical brake, see also section *Mechanical brake control*.

Control word bits 11/12, relay controlled via bits 11/12 in serial control word. Bit 11 relates to relay 01 and bit 12 to relay 04. If parameter 514 *Bus time interval function* is active, relays 01 and 04 will be voltage-free. See section on Serial communication in the Design Guide.

Extended mechanical brake control, enables control of an external mechanical brake, see also section *Mechanical brake control*.

Safety interlock The output is active when *Safety interlock* has been selected on an input and the input is a logic "1".

0-100 Hz ⇒ 0-20 mA and

0-100 Hz ⇒ 4-20 mA and

0-100 Hz ⇒ 0-32000 p, a pulse output signal proportional to the output frequency in the range 0-100 Hz.

0-f_{MAX} ⇒ 0-20 mA and

0-f_{MAX} ⇒ 4-20 mA and

0-f_{MAX} ⇒ 0-32000 p, an output signal proportional to the output frequency range in the range 0 - f_{MAX} (parameter 202).

Ref_{MIN} - Ref_{MAX} ⇒ 0-20 mA and

Ref_{MIN} - Ref_{MAX} ⇒ 4-20 mA and

Ref_{MIN} - Ref_{MAX} ⇒ 0-32000 p, an output signal proportional to the reference value in the interval Ref_{MIN} - Ref_{MAX} (parameters 204/205) is obtained.

B_{MIN} - FB_{MAX} ⇒ 0-20 mA and

FB_{MIN} - FB_{MAX} ⇒ 4-20 mA and

$FB_{MIN} - FB_{MAX} \Rightarrow 0-32000 p$, an output signal proportional to the feedback value in the interval $FB_{MIN} - FB_{MAX}$ (parameters 414/415) is obtained.

0 - $I_{VLT, MAX} \Rightarrow 0-20 mA$ or

0 - $I_{VLT, MAX} \Rightarrow 4-20 mA$ and

0 - $I_{VLT, MAX} \Rightarrow 0-32000 p$, an output signal proportional to the output current in the interval 0 - $I_{VLT, MAX}$ is obtained. $I_{VLT, MAX}$ depends on the settings in parameter 101 and 103 and can be seen from the *Technical data* ($I_{VLT, MAX}$ (60 s)).

0 - $M_{LIM} \Rightarrow 0-20 mA$ and

0 - $M_{LIM} \Rightarrow 4-20 mA$ and

0 - $M_{LIM} \Rightarrow 0-32000 p$, an output proportional to the output torque in the interval 0 - T_{LIM} (parameter 221) is obtained. 20 mA corresponds to the value set in parameter 221.

0 - $M_{NOM} \Rightarrow 0-20 mA$ and

0 - $M_{NOM} \Rightarrow 4-20 mA$ and

0 - $M_{NOM} \Rightarrow 0-32000 p$, an output signal proportional to the output torque of the motor. 20 mA corresponds to the rated torque for the motor.

0 - $P_{NOM} \Rightarrow 0-20 mA$ and

0 - $P_{NOM} \Rightarrow 4-20 mA$ and

0 - $P_{NOM} \Rightarrow 0-32000 p$, 0 - $P_{NOM} \Rightarrow 0-32000 p$, an output signal proportional to the rated motor output is obtained. 20 mA corresponds to the value set in parameter 102.

0 - $SyncRPM \Rightarrow 0-20 mA$ and

0 - $SyncRPM \Rightarrow 4-20 mA$ and

0 - $SyncRPM \Rightarrow 0-32000 p$, an output signal proportional to the synchronous motor RPM is obtained.

0 - RPM at $F_{MAX} \Rightarrow 0-20 mA$ and

0 - RPM at $F_{MAX} \Rightarrow 4-20 mA$ and

0 - RPM at $F_{MAX} \Rightarrow 0-32000 p$, an output signal proportional to the synchronous motor RPM at F_{MAX} (parameter 202) is obtained.

320 Terminal 42, output, pulse scaling (AO 42 PULS SCALE)

Value:

1 - 32000 Hz ☆ 5000 Hz

Function:

This parameter allows scaling of the pulse output signal.

Description of choice:

Set the desired value.

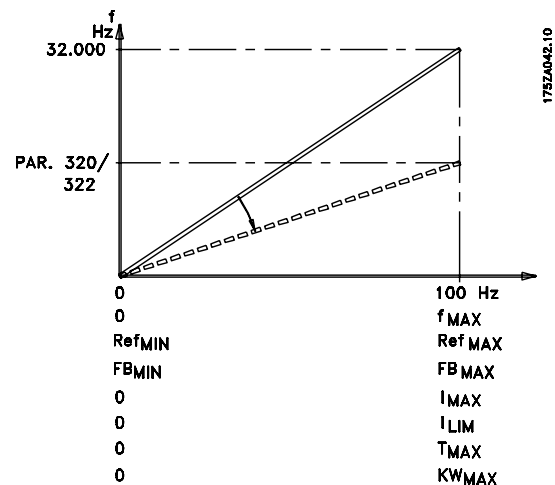

321 Terminal 45, output

(AO 45 FUNCT.)

Value:

See description for parameter 319.

Function:

This output can function both as a digital and an analogue output. Used as a digital output (data value [0]-[35]) it generates a 24 V (max. 40 mA) signal; on the analogue outputs (data value [36]-[59]) there is a choice of 0-20 mA, 4-20 mA or a scalable pulse output.

Description of choice:

See description for parameter 319.

322 Terminal 45, output, pulse scaling

(AO 45 PULS SCALE)

Value:

1 - 32000 Hz ☆ 5000 Hz

Function:

This parameter allows scaling of the pulse output signal.

Description of choice:

Set the desired value.

323 Relay 01, output

(RELAY 1-3 FUNCT.)

Value:

See description of parameter 319.

Function:

This output activates a relay switch.
Relay switch 01 can be used for bringing status and warnings. The relay is activated when the conditions for the relevant data values have been fulfilled.
Activation/deactivation can be delayed in parameter 324/325.

Description of choice:

See description of parameter 319.
Connections - see the below drawing.

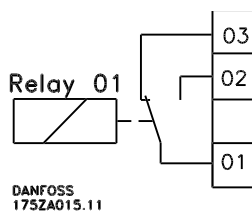

324 Relay 01, ON delay (RELAY 1-3 ON DL)

Value:

0.00 - 600.00. ☆ 0.00 sec.

Function:

This parameter allows a delay of the cut-in time of relay 01 (terminals 01-02).

Description of choice:

Enter the desired value (can be set at intervals of 0.02 sec.).

325 Relay 01, OFF delay (RELAY 1-3 OFF DL)

Value:

0.00 - 600.00 ☆ 0.00 sec.

Function:

This parameter makes it possible to delay the cut-out time of relay 01 (terminals 01-03).

Description of choice:

Enter the desired value (can be set at intervals of 0.02 sec.).

326 Relay 04, output (RELAY 4-5 FUNCT.)

Value:

See description of parameter 319.

Function:

This output activates a relay switch.
Relay switch 04 can be used for bringing status and warnings. The relay is activated when the conditions for the relevant data values have been fulfilled.

Description of choice:

See description of parameter 319.
Connections - see the below drawing.

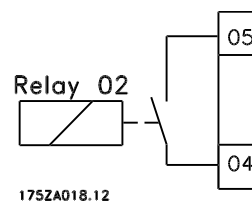

327 Pulse reference, max. frequency (PULSE REF MAX)

Value:

100 - 65000 Hz at terminal 29
100 - 5000 Hz at terminal 17 ☆ 5000 Hz

Function:

In this parameter, the signal value is set that corresponds to the maximum reference value set in parameter 205. Setting of this parameter affects an internal filter constant, i.e. at 100 Hz = 5 sec; 1 kHz = 0.5 sec. and at 10 kHz = 50 msec. To avoid a too long filter time constant at low pulse resolution, the reference (parameter 205) and this parameter can be multiplied by the same factor and in this way use the lower reference range.

Description of choice:

Set the desired pulse reference.

328 Pulse feedback, max. frequency (PULSE FEEDB MAX)

Value:

100 - 65000 Hz at terminal 33 ☆ 25000 Hz

Function:

This is where to set the feedback value that is to correspond to the maximum feed back value.

Description of choice:

Set the desired feedback value.

329 Encoder feedback pulse/rev. (ENCODER PULSES)

Value:

128 pulses /rev. (128)	[128]
256 pulses /rev. (256)	[256]
512 pulses /rev. (512)	[512]
★ 1024 pulses /rev. (1024)	[1024]
2048 pulses /rev. (2048)	[2048]
4096 pulses /rev. (4096)	[4096]

This value can also be set between 1-4096 pulses/rev.

Function:

This is where to set the encoder pulses per revolution that correspond to the motor rpm.

This parameter is only available in *Speed control, closed loop* and in *Torque control, speed feedback* (parameter 100).

Description of choice:

Read the correct value from the encoder. Pay attention to the speed limitation (rpm) for a given number of pulses/rpm, see the drawing below:

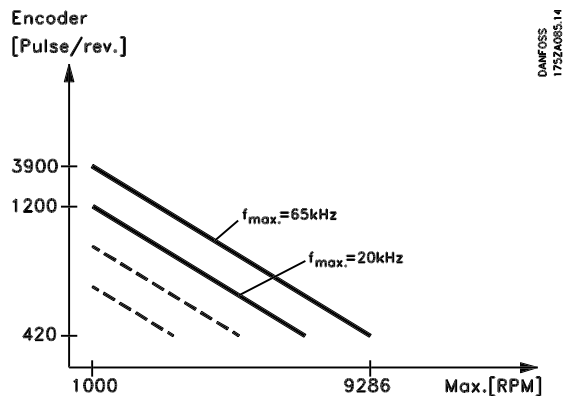

The encoder used is to be of the Open Collector PNP 0/24 V DC type (max. 20 kHz) or a Push-Pull circuit 0/24 V DC (max. 65 kHz).

330 Freeze reference/output function (FREEZE REF/OUTP.)

Value:

★ No operation (NO OPERATION)	[0]
Freeze reference (FREEZE REFERENCE)	[1]
Freeze output (FREEZE OUTPUT)	[2]

Function:

In this parameter it is possible to freeze either the reference or the output.

Description of choice:

Freeze reference [1] freezes the actual reference. The frozen reference is now the basis for *Speed up* and *Speed down*.

Freeze output [2] freezes the actual motor frequency (Hz). The frozen frequency is now the basis for *Speed up* and *Speed down*.



NB!

If *Freeze output* is active, the frequency converter cannot be stopped via terminals 18 and 19, but only via terminal 27 (to be programmed for *Coasting stop, inverse* [0] or *Reset and coasting stop, inverse* [1]).

After *Freeze output*, the PID integrators are reset.

345 Encoder loss timeout (ENC LOSS TIMEOUT)

Value:

0 - 60 sec.	★ 1 sec.
-------------	----------

Function:

If the encoder signal is interrupted from terminal 32 or 33 the function selected in parameter 346 will be activated.

If the encoder feedback signal is different from the output frequency +/- 3 x nominal motor slip the encoder loss function will be activated.

An encoder loss timeout can occur even if the encoder works all right. Check the motor parameter in group 100 if no error can be found on the encoder.

The Encoder loss function is only active in *Speed control, closed loop* [1] and *Torque control, speed feedback* [5], see parameter 100 *Configuration*.

Description of choice:

Set the required time.

346 Encoder loss function (ENC. LOSS FUNC)

Value:

★ Off (OFF)	[0]
Freeze output frequency (FREEZE OUTPUT FREQ.)	[1]

★ = factory setting, () = display text, [] = value for use in communication via serial communication port

Jog (JOGGING)	[3]
Max. speed (MAX SPEED)	[4]
Stop and trip (STOP AND TRIP)	[5]
Select Setup 4 (SELECT SETUP 4)	[7]

Function:

In this parameter the function can be activated if the encoder signal is disconnected from terminal 32 or 33.

If more time-outs occur at the same time the frequency converter will give the following priority to the time-out function:

1. Parameter 318 *Function after time out*
2. Parameter 346 *Function after encoder loss*
3. Parameter 514 *Bus time interval function.*

Description of choice:

The output frequency of the frequency converter can be:

- frozen at the present value
- overruled to jog frequency
- overruled to max. frequency
- overruled to stop with subsequent trip
- overruled to Setup 4.

357 Terminal 42, Output minimum scaling (out 42 scal min)

359 Terminal 45, Output minimum scaling (out 45 scal min)

Value:

000 - 100% ★ 0%

Function:

These parameters are to scale the minimum output of the selected analogue/pulse signal on terminals 42 and 45.

Description of choice:

The minimum value is to be scaled as a percentage of the maximum signal value, i.e. 0mA (or 0 Hz) is desired at 25% of the maximum output value, and then 25% is programmed.

The value can never be higher than the corresponding setting of *Output maximum scaling* if this value is below 100%.

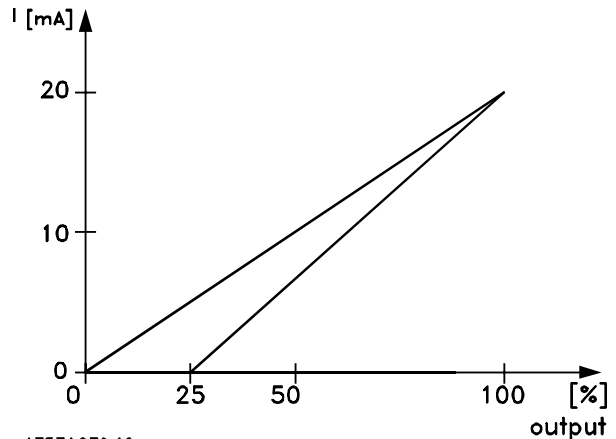

358 Terminal 42, Output maximum scaling (out 42 scal max)

360 Terminal 45, Output maximum scaling (out 45 scal max)

Value:

000 - 500% ★ 100%

Function:

These parameters are to scale the maximum output of the selected analogue/pulse signal on terminals 42 and 45.

Description of choice:

Set the value to the desired maximum value of the current signal output.

Maximum value:

The output can be scaled to give a lower current than 20 mA at full scale or 20 mA at an output below 100% of the maximum signal value.

If 20 mA is the desired output current at a value between 0 - 100% of the full-scale output, program the percentage value in the parameter, i.e. 50% = 20 mA. If a current between 4 and 20 mA is desired at maximum output (100%), the percentage value to program in the drive is calculated as:

$$\frac{20 \text{ mA}}{\text{desired maximum current}} \times 100 \%,$$

i.e. $10 \text{ mA} \approx \frac{20}{10} \times 100 \% \approx 200 \%$

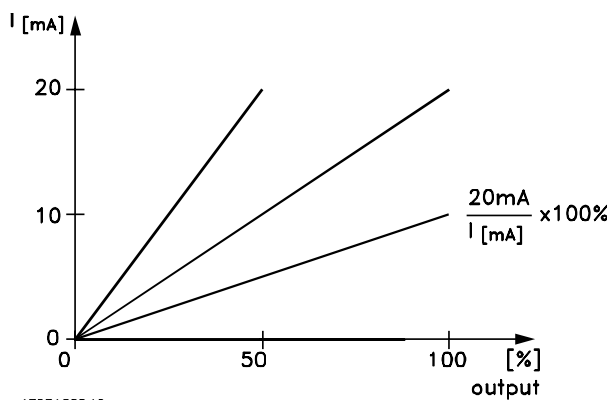

175ZA680.10

A similar scaling is possible on the pulse output. The value (pulse scale value) in parameter 320 (output 42) and 321 (output 45) is the basis of the scaling. If the pulse scale value is the desired output at a value between 0 - 100% of the full scale output, program the percentage, i.e. 50% for pulse scale value at 50% output.

If a pulse frequency between 0,2 x pulse scale value and pulse scale value, the percentage is calculated as follows:

$$\frac{\text{Pulse scale value (par. 320 or 321)}}{\text{Desired pulse frequency}} \times 100 \%$$

i.e.

$$2000 \text{ Hz} \approx \frac{5000 \text{ Hz}}{2000 \text{ Hz}} \times 100 \% \approx 250 \%$$

Function:

This parameter adjusts the threshold level for detection of encoder loss in speed closed loop mode. The value equals a percentage of the nominal slip of the motor.

Description of choice:

Set the desired threshold level.

361 Encoder loss threshold

(ENCODER MAX ERR.)

Value:

0 - 600%

★ 300%

Parameters - Special functions

400 Brake function/overvoltage control (BRAKE FUNCTION)	
Value:	
☆ Off (OFF)	[0]
Resistor brake (RESISTOR)	[1]
Overvoltage control (OVERVOLTAGE CONTROL)	[2]
Overvoltage control and stop (OVERVOLT CTRL. & STOP)	[3]

Function:

The factory setting is *Off* [0] for VLT 5001-5027 200-240 V, VLT 5001-5102 380-500 V and VLT 5001-5062 525-600 V. For VLT 5032-5052 200-240 V, 5122-5552 380-500 V, and VLT 5042-5602 525-690 V the factory setting is *Overvoltage control* [2].

Resistor brake [1] is used for programming the frequency converter for connection of a brake resistor. The connection of a brake resistor allows a higher intermediate circuit voltage during braking (generating operation).

The *Resistor brake* [1] function is only active in units with an integral dynamic brake (SB and EB units).

Overvoltage control (excl. brake resistor) can be selected as an alternative. This function is available in all variants.

The function ensures that a trip can be avoided if the intermediate circuit voltage increases. This is done by increasing the output frequency to limit the voltage from the intermediate circuit. This is a very useful function, e.g. if the ramp-down time is too short, since tripping of the frequency converter is avoided. In this situation, the ramp-down time is extended.



NB!

Please note that the ramp-down time is extended in the case of overvoltage control, which in some applications may not be appropriate.

Description of choice:

Select *Resistor brake* [1] if a brake resistor is part of the SYSTEM.

Select *Overvoltage control* [2] if the overvoltage control function is required in all cases - also if stop is pressed. The frequency converter will not stop in the case of a stop command when the overvoltage control is active.

Select *Overvoltage control and stop* [3] if the overvoltage control function is not required during ramp-down after stop has been pressed.



Warning: If *Overvoltage control* [2] is used at the same time as the supply voltage to the frequency converter is close to or above the maximum limit, there is a risk that the motor frequency will increase and that, consequently, the frequency converter will not stop the motor when stop is pressed. If the supply voltage is higher than 264 V for 200-240 V units, higher than:

- 264 V for 200-240 V units
- 550 V for 380-500 V units
- 660 V for 525-600 V units
- 759 V for 525-690 V units

Overvoltage control and stop [3] should be selected so that the motor can be stopped.

401 Brake resistor, ohm (BRAKE RES. (OHM))

Value:

Depends on the unit ☆ Depends on the unit

Function:

This parameter gives the ohmic value of the brake resistor. This value is used for monitoring the power to the brake resistor provided this function has been selected in parameter 403.

Description of choice:

Set the present resistor value.

402 Brake power limit, kW (BR.POWER. LIM.KW)

Value:

Depends on the unit ☆ Depends on the unit

Function:

This parameter gives the monitoring limit of the power transmitted to the brake resistor.

Description of choice:

The monitoring limit is determined as a product of the maximum duty cycle (120 sec.) that will occur and the maximum power of the brake resistor at that duty cycle according to the following formula.

☆ = factory setting, () = display text, [] = value for use in communication via serial communication port

For 200 - 240 V units: $P = \frac{397^2 \times t}{R \times 120}$

For 380 - 500 V units: $P = \frac{822^2 \times t}{R \times 120}$

For 525 - 600 V units: $P = \frac{958^2 \times t}{R \times 120}$

For 525 - 690 V units: $P = \frac{1084^2 \times t}{R \times 120}$

403 Power monitoring (POWER MONITORING)	
Value:	
Off (OFF)	[0]
★ Warning (Warning)	[1]
Trip (TRIP)	[2]

Function:
This parameter allows monitoring of the power transmitted to the brake resistor. The power is calculated on the basis of the resistor ohm value (parameter 401), the intermediate circuit voltage and the resistor running time. If the power transmitted over 120 sec. exceeds 100% of the monitoring limit (parameter 402) and *Warning* [1] has been selected, a warning will come up on the display. The warning will disappear if the power goes below 80%. If the calculated power exceeds 100% of the monitoring limit and *Trip* [2] has been selected in parameter 403 *Power monitoring*, the frequency converter will cut out while giving an alarm. If power monitoring has been selected as *Off* [0] or *Warning* [1], the brake function will remain active, even if the monitoring limit has been exceeded. This may lead to thermal overload of the resistor. It is also possible to have a warning via the relay/digital outputs. The typical measuring accuracy of the power monitoring depends on the accuracy of the resistor ohmic value (better than ± 20%).



NB!
The power dissipation during quick discharge does not form part of the power monitoring function.

Description of choice:
Select whether this function is to be active (*Warning/Alarm*) or inactive (*Off*).

404 Brake check (BRAKE TEST)	
Value:	
★ Off (OFF)	[0]
Warning (WARNING)	[1]
Trip (TRIP)	[2]

Function:
In this parameter a testing and monitoring function can be integrated which will give a warning or an alarm. On power-up it will be tested whether the brake resistor is disconnected. The test of whether the brake resistor is disconnected is carried out during braking, while the test of whether the IGBT is disconnected is carried out when there is no braking. A warning or trip disconnects the brake function.
The testing sequence is as follows:

1. If the intermediate circuit voltage is higher than the brake starting voltage, discontinue the brake check.
2. If the intermediate circuit voltage is unstable, discontinue the brake check.
3. Carry out a brake test.
4. If the intermediate circuit voltage is lower than the starting voltage, discontinue the brake check.
5. If the intermediate circuit voltage is unstable, discontinue the brake check.
6. If the braking power is higher than 100%, discontinue the brake check.
7. If the intermediate circuit voltage is higher than the intermediate circuit voltage -2% before the brake test, discontinue the brake check and give off a warning or alarm.
8. Brake check OK.

Description of choice:
If *Off* [0] is selected, this function will still monitor whether the brake resistor and the brake IGBT short-circuit during operation, in which case it will give off a warning. If *Warning* [1] is selected, the brake resistor and brake IGBT will be monitored with respect to short-circuiting. In addition, on power-up it will be checked whether the brake resistor has been disconnected.

★ = factory setting, () = display text, [] = value for use in communication via serial communication port



NB!

A warning in connection with *Off* [0] or *Warning* [1] can only be removed by disconnecting the mains supply and turning it back on, provided the fault has been corrected. Please note that in connection with *Off* [0] or *Warning* [1] the frequency converter will continue even if a fault has been found.

In the case of *Trip* [2], the frequency converter will cut out while giving an alarm (trip locked) if the brake resistor has short-circuited or been disconnected or if the brake IGBT has short-circuited.



Warning: The motor may start without warning.

405 Reset function (RESET MODE)

Value:

★ Manual reset (MANUAL RESET)	[0]
Automatic reset x 1 (AUTOMATIC X 1)	[1]
Automatic reset x 2 (AUTOMATIC X 2)	[2]
Automatic reset x 3 (AUTOMATIC X 3)	[3]
Automatic reset x 4 (AUTOMATIC X 4)	[4]
Automatic reset x 5 (AUTOMATIC X 5)	[5]
Automatic reset x 6 (AUTOMATIC X 6)	[6]
Automatic reset x 7 (AUTOMATIC X 7)	[7]
Automatic reset x 8 (AUTOMATIC X 8)	[8]
Automatic reset x 9 (AUTOMATIC X 9)	[9]
Automatic reset x 10 (AUTOMATIC X 10)	[10]

Function:

This parameter makes it possible to select the reset function desired after tripping. After reset, the frequency converter can be restarted.

Description of choice:

If *Manual reset* [0] is selected, reset must be effected via the [RESET] key or via the digital inputs. If the frequency converter is to carry out an automatic reset (1-10 times) after tripping, select data value [1]-[10].



NB!

The internal AUTOMATIC RESET counter is reset 10 minutes after the first AUTOMATIC RESET has occurred.

406 Automatic restart time

(AUT RESTART TIME)

Value:

0 - 10 sec.

★ 5 sec.

Function:

This parameter allows setting of the time from tripping until the automatic reset function begins.

It is assumed that automatic reset has been selected in parameter 405.

Description of choice:

Set the desired time.

407 Mains failure

(MAINS FAILURE)

Value:

★ No function (NO FUNCTION)	[0]
Controlled ramp-down (CONTROL RAMP DOWN)	[1]
Controlled ramp-down and trip (CTRL. RAMP DOWN-TRIP)	[2]
Coasting (COASTING)	[3]
Kinetic back-up (KINETIC BACKUP)	[4]
Controlled alarm suppression (ctrl alarm supp)	[5]

Function:

Using the mains failure function, it is possible to ramp down the load to 0 Hz if the mains supply to the frequency converter fails.

In parameter 450 *Mains voltage during mains fault*, the voltage limit must be set at which the *Mains fault* function is to be active.

This function can also be activated by selecting *Mains failure inverted* on a digital input.

When *Kinetic backup* [4] is selected, the ramp function in parameter 206-212 is deactivated.

Controlled ramp down and kinetic back up have limited performance above 70% load.

Description of choice:

Select *No function* [0] if this function is not required. If *Controlled ramp-down* [1] is selected, the motor will ramp via the quick-stop ramp set in parameter 212. If the supply voltage is re-established during ramp-down, the frequency converter will start up again. If *Controlled ramp-down and trip* [2] is selected, the motor will ramp via the quick-stop ramp set in parameter 212.

At 0 Hz the frequency converter will trip (ALARM 36, mains failure). If the supply voltage is re-established during ramp-down, the frequency converter will continue the quick-stop ramp and trip. If *Coasting* [3] is selected, the frequency converter will turn off the inverters and the motor will start coasting.

Parameter 445 *Flying motor* must be active, so that if the supply voltage is re-established, the frequency converter will be able to catch the motor and start up again.

If *Kinetic back-up* [4] is selected, the frequency converter will try to utilise the energy from the load to maintain a constant intermediate circuit voltage. If the supply voltage is re-established, the frequency converter will start up again.

If *Controlled alarm suppression* [5] is selected, the frequency converter will trip if there is a mains failure and the unit is not stopped by OFF1, OFF2 or OFF3 via the Profibus. Only active with Fieldbus profile (par. 512) selected and Profibus installed.

408 Quick discharge

(QUICK DISCHARGE)

Value:

- ★ Not possible (DISABLE) [0]
- Possible (ENABLE) [1]

Function:

The option is given of quickly discharging the intermediate circuit capacitors by means of an external resistor.

Description of choice:

This function is only active in extended units, since it requires the connection of external 24 V DC and a brake resistor or discharge resistor; otherwise, the data selection is limited to *Disable* [0].

This function can be activated by selecting a digital input signal for *Mains failure inverted*. Select *Disable* if this function is not required. Select *Enable* and connect 24 V DC external supply and a brake/discharge resistor.

See section *Quick discharge*.

409 Trip delay torque

(TRIP DELAY TORQ.)

Value:

- 0 - 60 sec. (OFF) ★ OFF

Function:

When the frequency converter registers that the output torque has increased up to the torque limits (parameters 221 and 222) in the set time, cutting out is effected when that time has passed.

Description of choice:

Select how long the frequency converter is to be able to run at the torque limit before cutting out. 60 sec. = OFF means that the time is infinite; however, the thermal monitoring will still be active.

410 Trip delay-inverter

(INV.FAULT DELAY)

Value:

- 0 - 35 sec. ★ Depends on type of unit

Function:

When the frequency converter registers an overvoltage in the set time, cutting out is effected after that time has passed.

Description of choice:

Select how long the frequency converter is to be able to run at overvoltage before cutting out.



NB!

If this value is reduced from the factory setting, the unit may report a fault when the mains voltage is turned on.

411 Switching frequency

(SWITCH FREQ.)

Value:

- ★ Depends on the unit output.

Function:

The set value determines the switching frequency of the frequency converter. If the switching frequency is

★ = factory setting, () = display text, [] = value for use in communication via serial communication port

changed, this may help to minimise possible acoustic noise from the motor.



NB!

The output frequency of the frequency converter can never assume a value higher than 1/10 of the switching frequency.

Description of choice:

When the motor is running, the switching frequency is adjusted in parameter 411 until the frequency has been obtained at which the motor is as low-noise as possible.

See also parameter 446 - switching pattern. See derating in the Design Guide.



NB!

Switching frequencies higher than 3.0 kHz (4.5 kHz for 60°C AVM) lead to automatic derating of the maximum output of the frequency converter.

412 Output frequency dependent switching frequency (VAR CARRIER FREQ)

Value:

- ★ Not possible (DISABLE) [0]
- Possible (ENABLE) [1]

Function:

This function makes it possible to increase the switching frequency at a falling output frequency. Used in applications with square torque characteristics (centrifugal pumps and fans) in which the load declines depending on the output frequency. However, the maximum switching frequency is determined by the value set in parameter 411.

Description of choice:

Select *Not possible* [0] if a permanent switching frequency is desired.

Set the switching frequency in parameter 411. If *Possible* [1] is selected the switching frequency will decline at an increasing output frequency.

413 Overmodulation function (OVERMODUL)

Value:

- Off (OFF) [0]

- ★ On (ON) [1]

Function:

This parameter allows connection of the overmodulation function for the output voltage.

Description of choice:

Off means that there is no overmodulation of the output voltage, which means that torque ripple on the motor shaft is avoided. This can be a good feature, e.g. on grinding machines.

On means that an output voltage can be obtained which is greater than the mains voltage (up to 15%).

414 Minimum feedback (MIN. FEEDBACK)

Value:

- 100,000.000 - Max. feedback ★ 0.000

Function:

Parameters 414 and 415 are used to scale the display text to make it show the feedback signal as the actual unit proportional to the signal on the input. This value will be displayed if *Feedback [unit]* [3] has been selected in one of parameters 009-012 and in the display mode. Choose the feedback signal unit in parameter 416.

Used together with *Speed control, closed loop; Process control, closed loop* and *Torque control speed feedback*, (parameter 100).

Description of choice:

Is only active when parameter 203 has been set to *Min-Max* [0].

Set the value to be shown on the display when *Minimum feedback* is obtained on the selected feedback input (parameter 308 or 314).

The minimum value can be limited by the choice of configuration (parameter 100) and reference/feedback range (parameter 203).

If *Speed control, closed loop* [1] has been selected in parameter 100, minimum feedback cannot be set under 0.

415 Maximum feedback (MAX. FEEDBACK)

Value:

- Min. feedback - 100,000.000 ★ 1,500.000

★ = factory setting, () = display text, [] = value for use in communication via serial communication port

Function:

This value should be 10% higher than par. 205 *Maximum reference*, to keep the frequency converter from integrating as a response to a possible offset fault. For further description, see parameter 414.

Description of choice:

Set the value to be shown on the display when *Maximum feedback is obtained on the selected feedback input (parameter 308 or 314)*. The maximum value can be limited by the choice of configuration (parameter 100).

ft ³ /s	[30]
gal/min	[31]
ft ³ /min	[32]
gal/h	[33]
ft ³ /h	[34]
lb/s	[35]
lb/min	[36]
lb/h	[37]
lb ft	[38]
ft/s	[39]
ft/min	[40]

416 Reference/feedback unit

(REF/FEEDB. UNIT)

Value:

NO UNIT	[0]
★ %	[1]
PPM	[2]
RPM	[3]
bar	[4]
CYCLE/min	[5]
PULSE/s	[6]
UNITSS/s	[7]
UNITS/min	[8]
UNITS/h	[9]
°C	[10]
Pa	[11]
l/s	[12]
m ³ /s	[13]
l/min	[14]
m ³ /min	[15]
l/h	[16]
m ³ /h	[17]
kg/s	[18]
kg/min	[19]
kg/h	[20]
t/min	[21]
t/h	[22]
m	[23]
N m	[24]
m/s	[25]
m/min	[26]
°F	[27]
in wg	[28]
gal/s	[29]

Function:

Choose among different units to be shown on the display.

This unit is also used directly in *Process control, closed loop* as a unit for *Minimum/Maximum reference (parameters 204/205)* and *i*.

The possibility of choosing a unit in parameter 416 will depend on the choices made in the following parameters:

Par. 002 *Local/remote control*.

Par. 013 *Local control/config. as par. 100*.

Par. 100 *Configuration*.

Select parameter 002 as Remote control

If parameter 100 is selected as *Speed control, open loop* or *Torque control, open loop*, the unit selected in parameter 416 can be used in displays (par. 009-12 *Feedback [unit]*) of process parameters.

The process parameter to be displayed can be connected in the form of an external analogue signal to terminal 53 (par. 308: *Feedback signal*) or terminal 60 (par. 314: *Feedback signal*), as well as in the form of a pulse signal on terminal 33 (par. 307: *Pulse feedback*).

Note: The reference can only be shown in Hz (*Speed control, open loop*) or Nm (*Torque control, open loop*). If par. 100 is selected as *Speed control, closed loop*, parameter 416 is not active, since both reference and feedback are always shown as RPM.

If parameter 100 is selected as *Process control, closed loop*, the unit selected in parameter 416 will be used when displaying both reference (par. 009-12: *Reference [unit]*) and feedback (par. 009-12: *Feedback [unit]*).

Scaling of the display indication as a function of the selected range (par. 309/310, 312/313, 315/316, 327 and 328) for a connected, external signal is effected

★ = factory setting, () = display text, [] = value for use in communication via serial communication port

for a reference in parameters 204 and 205 and for feedback in parameters 414 and 415.

Select parameter 002 as Local control

If parameter 013 is chosen as *LCP control and open loop* or *LCP digital control and open loop*, the reference will be given in Hz, regardless of the choice made in parameter 416. A feedback or process signal connected to terminal 53, 60 or 33 (pulse), will, however, be displayed in the form of the unit selected in parameter 416. If parameter 013 is chosen as *LCP control/as par. 100* or *LCP digital control/as par. 100*, the unit will be as described above under parameter 002, Remote-control.



NB!

The above applies to display of *Reference [unit]* and *Feedback [unit]*. If *Reference [%]* or *Feedback [%]* is selected, the value displayed will be in the form of a percentage of the selected range.

Description of choice:

Select the desired unit for the reference/feedback signal.

417 Speed PID proportional gain (SPEED PROP GAIN)

Value:

0.000 (OFF) - 0.150 ☆ 0.015

Function:

Proportional gain indicates how many times the fault (deviation between the feedback signal and the set-point) is to be amplified. Used together with *Speed control, closed loop* (parameter 100).

Description of choice:

Quick control is obtained at high amplification, but if the amplification is too high, the process may become unstable in the case of overshoot.

418 Speed PID integral time (SPEED INT. TIME)

Value:

2.00 - 999.99 ms (1000 = OFF) ☆ 8 ms

Function:

The integral time determines how long the PID regulator takes to correct the error. The greater the error, the quicker the gain increases. The integral time results in a delay of the signal and thus has a dampening effect. Used together with *Speed control, closed loop* (parameter 100).

Description of choice:

Quick control is obtained through a short integral time. However, if this time is too short, it can make the process unstable.

If the integral time is long, major deviations from the required reference may occur, since the process regulator will take long to regulate if an error has occurred.

419 Speed PID differential time (SPEED DIFF. TIME)

Value:

0.00 (OFF) - 200.00 ms ☆ 30 ms

Function:

The differentiator does not react to a constant error. It only provides a gain if the error changes. The quicker the error changes, the stronger the gain from the differentiator will be.

The gain is proportional to the speed at which errors change.

Used together with *Speed control, closed loop* (parameter 100).

Description of choice:

Select the desired gain limit.

420 Speed PID D-gain limit (SPEED D-GAIN LIMIT)

Value:

5.0 - 50.0 ☆ 5.0

Function:

It is possible to set a limit for the gain provided by the differentiator. Since the D-gain increases at higher frequencies, limiting the gain may be useful.

This enables obtaining a pure D-link at low frequencies and a constant D-link at higher frequencies.

Used together with *Speed control, closed loop* (parameter 100).

Description of choice:

Select the desired gain limit.

421 Speed PID lowpass filter time (SPEED FILT. TIME)

Value:

5 - 200 ms ★ 10 ms

Function:

Oscillations on the feedback signal are dampened by a lowpass filter so as to reduce their influence on control. This might be an advantage, e.g. if there is a great amount on noise on the system. See drawing. Used together with *Speed control, closed loop* and *Torque control, speed feedback* (parameter 100).

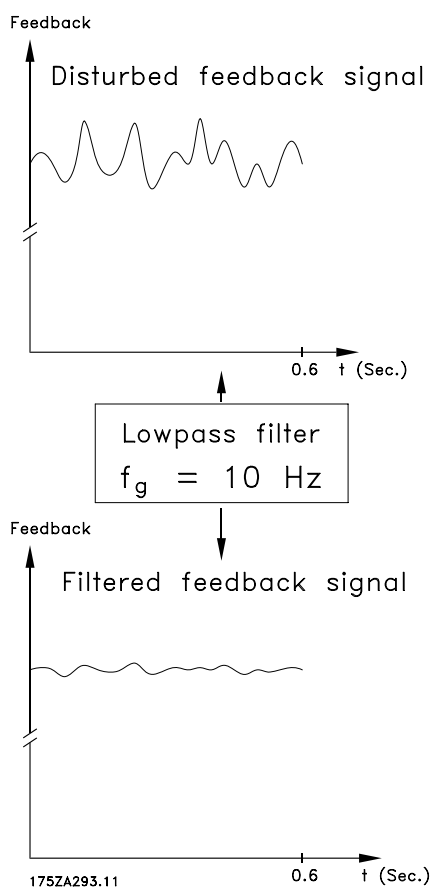

Description of choice:

If a time constant (τ) e.g. of 100 ms is programmed, the cut-off frequency for the lowpass filter will be $1/0.1 = 10 \text{ RAD/sec.}$, corresponding to $(10/2 \times \pi) = 1.6 \text{ Hz.}$ This means that the PID regulator will only regulate a feedback signal that varies by a frequency of less than 1.6 Hz. If the feedback signal varies by a higher frequency than 1.6 Hz, the PID regulator will not react.

422 U 0 voltage at 0 Hz (U0 VOLTAGE (0HZ))

Value:

0.0 - parameter 103 ★ 20.0 volt

Function:

Parameters 422-432 can be used together with Special motor characteristics (par. 101). It is possible to make a U/f characteristic on the basis of six definable voltages and frequencies. Change of motor nameplate data (parameter 102 - 106) affects parameter 422.

Description of choice:

Set the desired voltage at 0 Hz.

See the below drawing.

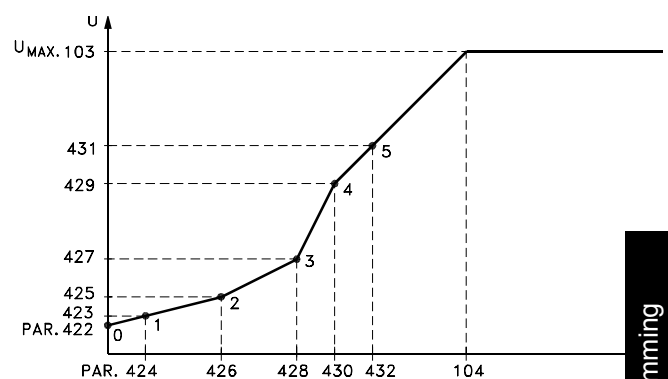

423 U 1 voltage (U1 VOLTAGE)

Value:

0.0 - $U_{VLT,MAX}$ Factory setting of par. 103

Function:

This parameter sets the Y-value of the 1st break point.

Description of choice:

Set the voltage desired at the F1 frequency set in parameter 424.

See drawing for parameter 422.

424 F 1 frequency (F1 FREQUENCY)

Value:

0.0 - par. 426 Factory setting of par. 104

Function:

This parameter sets the X-value of the 1st break point.

Description of choice:

Set the frequency desired at the U1 voltage set in parameter 423.

See drawing for parameter 422.

425 U 2 voltage
(U2 VOLTAGE)
Value:

0.0 - $U_{VLT, MAX}$ Factory setting of par. 103

Function:

This parameter sets the Y-value of the 2nd break point.

Description of choice:

Set the voltage desired at the F2 frequency set in parameter 426.

See drawing for parameter 422.

426 F 2 frequency
(F2 FREQUENCY)
Value:

par. 424 - par. 428 Factory setting of par. 104

Function:

This parameter sets the X-value of the 2nd break point.

Description of choice:

Set the frequency desired at the U2 voltage set in parameter 425.

See drawing for parameter 422.

427 U 3 voltage
(U3 VOLTAGE)
Value:

0.0 - $U_{VLT, MAX}$ Factory setting of par. 103

Function:

This parameter sets the Y-value of the 3rd break point.

Description of choice:

Set the voltage desired at the F3 frequency set in parameter 428.

See drawing for parameter 422.

428 F 3 frequency
(F3 FREQUENCY)
Value:

par. 426 - par. 430 Factory setting of par. 104

Function:

This parameter sets the X-value of the 3rd break point.

Description of choice:

Set the frequency desired at the U3 voltage set in parameter 427.

See drawing for parameter 422.

429 U 4 voltage
(U4 VOLTAGE)
Value:

0.0 - $U_{VLT, MAX}$ Factory setting of par. 103

Function:

This parameter sets the Y-value of the 4th break point.

Description of choice:

Set the voltage desired at the F4 frequency set in parameter 430.

See drawing for parameter 422.

430 F 4 frequency
(F4 FREQUENCY)
Value:

par. 428 - par. 432 Factory setting of par. 104

Function:

This parameter sets the X-value of the 4th break point

Description of choice:

Set the frequency desired at the U4 voltage set in parameter 429.

See drawing for parameter 422.

431 U 5 voltage
(U5 VOLTAGE)
Value:

0.0 - $U_{VLT, MAX}$ Factory setting of par. 103

Function:

This parameter sets the Y-value of the 5th break point.

Description of choice:

Set the voltage desired at the F5 frequency set in parameter 432.

432 F 5 frequency
(F5 FREQUENCY)
Value:

★ = factory setting, () = display text, [] = value for use in communication via serial communication port

par. 430 - 1000 Hz Factory setting of par. 104

Function:

This parameter sets the X-value of the 5th break point. This parameter is not limited by parameter 200.

Description of choice:

Set the frequency desired at the U5 voltage set in parameter 431.

See drawing for parameter 422.

433 Torque control, open loop proportional gain

(TOR-OL PROP. GAIN)

Value:

0 (Off) - 500% ★ 100%

Function:

The proportional gain indicates how many times the error (the deviation between feedback signal and set point) is to be applied.

Used together with *Torque control, open loop* (parameter 100).

Description of choice:

Fast control is obtained with a high gain, but if the gain is too high, the process may become unstable.

434 Torque control, open loop Integration time

(TOR-OL INT.TIME)

Value:

0.002 - 2.000 sec. ★ 0.02 sec.

Function:

The integrator provides an increasing gain if there is a constant error between reference and current measuring signal. The greater the error, the quicker the gain increases. The integral time is the time required by the integrator to reach the same gain as the proportional gain.

Used together with *Torque control, open loop* (parameter 100).

Description of choice:

Fast control is obtained if the integral time is short. However, this time may become too short, in which case the process may become unstable.

437 Process PID Normal/inverse control

(PROC NO/INV CTRL)

Value:

Normal (NORMAL) [0]

★ Inverse (INVERSE) [1]

Function:

It is possible to choose whether the process regulator is to increase/reduce the output frequency. This is done by having a difference between the reference signal and the feedback signal.

Used together with *Process control, closed loop* (parameter 100).

Description of choice:

If the frequency converter is to reduce the output frequency in case the feedback signal increases, select *Normal* [0].

If the frequency converter is to increase the output frequency in case the feedback signal increases, select *Inverse* [1].

438 Process PID anti windup

(PROC ANTI WINDUP)

Value:

Off (DISABLE) [0]

★ On (ENABLE) [1]

Function:

It is possible to select whether the process regulator is to continue regulating on an error even if it is not possible to increase/reduce the output frequency.

Used together with *Process control, closed loop* (parameter 100).

Description of choice:

The factory setting is *Enable* [1], which means that the integration link is adjusted in relation to the actual output frequency if either the current limit or the max./min. frequency has been reached. The process regulator will not engage again until either the error is zero or its sign has changed.

Select *Disable* [0] if the integrator is to continue integrating on an error, even if it is not possible to remove the fault by such control.



NB!

If *Disable* [0] is selected, it will mean that when the error changes its sign, the integrator will first have to integrate down from the level obtained as a result of the former error, before any change to the output frequency occurs.

439 Process PID start frequency (PROC START VALUE)

Value:

$f_{MIN} - f_{MAX}$
(parameter 201 and 202) ★ parameter 201

Function:

When the start signal comes, the frequency converter will react in the form of *Speed control, open loop* following the ramp. Only when the programmed start frequency has been obtained, will it change over to *Process control, closed loop*. In addition, it is possible to set a frequency that corresponds to the speed at which the process normally runs, which will enable the required process conditions to be reached sooner. Used together with *Process control, closed loop* (parameter 100).

Description of choice:

Set the required start frequency.



NB!

If the frequency converter is running at the current limit before the desired start frequency is obtained, the process regulator will not be activated. For the regulator to be activated anyway, the start frequency must be lowered to the required output frequency. This can be done during operation.

440 Process PID proportional gain (PROC. PROP. GAIN)

Value:

0.00 - 10.00 ★ 0.01

Function:

The proportional gain indicates the number of times the error between the set point and the feedback signal is to be applied.

Used together with *Process control, closed loop* (parameter 100).

Description of choice:

Quick control is obtained by a high gain, but if the gain is too high, the process may become unstable.

441 Process PID integral time (PROC. INTEGR. T.)

Value:

0.01 - 9999.99 sec. (OFF) ★ OFF

Function:

The integrator provides an increasing gain at a constant error between the set point and the feedback signal. The greater the error, the quicker the gain will increase. The integral time is the time needed by the integrator to reach the same gain as the proportional gain.

The gain is proportional to the speed at which the error changes.

Used together with *Process control, closed loop* (parameter 100).

Description of choice:

Quick control is obtained at a short integral time. However, this time may become too short, which can make the process unstable.

If the integral time is long, major deviations from the required set point may occur, since the process regulator will take a long time to regulate in relation to a given error.

442 Process PID differentiation time (PROC. DIFF. TIME)

Value:

0.00 (OFF) - 10.00 sec. ★ 0.00 sec.

Function:

The differentiator does not react to a constant error. It only provides a gain when the error changes. The quicker the error changes, the stronger the gain from the differentiator.

The gain is proportional to the speed at which the error changes.

Used together with *Process control, closed loop* (parameter 100).

Description of choice:

Quick control is obtained with a long differentiation time. However, this time may become too long, which can make the process unstable.

443 Process PID diff. gain limit (PROC. DIFF. GAIN)

Value:

5.0 - 50.0 ☆ 5.0

Function:

It is possible to set a limit for the differentiator gain. The differentiator gain will increase if there are fast changes, which is why it can be beneficial to limit this gain, thereby obtaining a pure differentiator gain at slow changes and a constant differentiator gain where quick changes to the error occur.

Used together with *Process control, closed loop* (parameter 100).

Description of choice:

Select a limit to differentiator gain as required.

444 Process PID lowpass filter time (PROC FILTER TIME)

Value:

0.01 - 10.00 ☆ 0.01

Function:

Oscillations on the feedback signal are dampened by the lowpass filter in order to reduce their impact on the process control. This can be an advantage e.g. if there is a lot of noise on the signal.

Used together with *Process control, closed loop* (parameter 100).

Description of choice:

Select the desired time constant (τ). If a time constant (τ) of 100 ms is programmed, the break frequency for the lowpass filter will be $1/0.1 = 10$ RAD/sec., corresponding to $(10/2 \times \pi) = 1.6$ Hz.

The process regulator will thus only regulate a feedback signal that varies by a frequency lower than 1.6 Hz. If the feedback signal varies by a higher frequency than 1.6 Hz, the Process regulator will not react.

445 Flying start (FLYING START)

Value:

☆ Off (DISABLE) [0]
On (ENABLE) [1]

Function:

This function makes it possible to catch spinning motor, which is spinning freely because of a mains drop-out.

Description of choice:

Select *Disable* if this function is not required. Select *Enable* if the frequency converter is to be able to 'catch' and control a spinning motor.

446 Switching pattern (SWITCH PATTERN)

Value:

60° AVM (60° AVM) [0]
☆ SFAVM (SFAVM) [1]

Function:

Choose between two different switching patterns: 60° AVM and SFAVM.

Description of choice:

Select 60° AVM if the option of using a switching frequency up to 14/10 kHz is required. Derating of the rated output current $I_{VLT.N}$ is effected from a switching frequency of 4.5 kHz.

Select SFAVM if the option of using a switching frequency up to 5/10 kHz is required. Derating of the rated output current $I_{VLT.N}$ is effected from a switching frequency of 3.0 kHz.

447 Torque, speed feedback Torque compensation (TOR-SF COMP.)

Value:

-100 - 100% ☆ 0%

Function:

This parameter is only used if *Torque control, speed feedback* [5] has been selected in parameter 100. Torque compensation is used in connection with calibration of the frequency converter. By adjusting parameter 447, *Torque compensation*, the output torque can be calibrated.

See section *Setting of parameters, torque regulation, speed feedback*.

Description of choice:

Set the required value.

448 Torque, speed feedback Gear ratio with encoder

(TOR-SF GEARRATIO)

Value:

0.001 - 100.000 ☆ 1.000

Function:

This parameter is only used if *Torque control, speed feedback* [5] has been selected in parameter 100. If an encoder has been fitted to the gearshaft, a gear ratio must be set - otherwise the frequency converter will not be able to calculate the output frequency correctly. For a gear ratio of 1:10 (gearing down of motor rpm), set the parameter value to 10.

If the encoder has been fitted directly on the motor shaft, set the gear ratio to 1.00.

Description of choice:

Set the required value.

449 Torque, speed feedback Friction loss

(TOR-SF FRIC. LOSS)

Value:

0.00 - 50.00% of rated motor torque ☆ 0.00%

Function:

This parameter is only used if *Torque control, speed feedback* [5] has been selected in parameter 100.

Set the friction loss as a fixed percentage loss of rated torque. In motor operation, the friction loss will be added to the torque, while in generating operation it will be deducted from the torque.

See section *Setting of parameters, torque regulation, speed feedback*.

Description of choice:

Set the required value.

450 Mains voltage at mains fault

(MAINS FAIL VOLT.)

Value:

180-240 V for 200-240 V units	☆ 180
342-500 V for 380-500 V units	☆ 342
473-600 V for 525-600 V units	☆ 495
473-690 V for 525-690 V units	☆ 495

Function:

Set the voltage level at which parameter 407 Mains fault is to be activated. The voltage level for activating the mains fault functions must be lower than the rated mains voltage supplied to the frequency converter. As a rule of thumb, parameter 450 can be set to 10% below the rated mains voltage.

Description of choice:

Set the level for activating mains fault functions.



NB!

If this value is set at too high a level, the mains fault function set in parameter 407 can be activated, even if the mains voltage is present.

453 Speed closed loop gear ratio

(SPEED GEARRATIO)

Value:

0.01 - 100.00 ☆ 1.00

Function:

This parameter is only used if *Speed control, closed loop* [1] has been selected in parameter 100 *Configuration*.

If the feedback has been fitted to the gearshaft, a gear ratio must be set - otherwise the frequency converter will not be able to detect an encoder loss.

For a gear ratio of 1:10 (gearing down of motor rpm), set the parameter value to 10.

If the encoder has been fitted directly on the motor shaft, set the gear ratio to 1.00.

Please note, that this parameter only has influence on the encoder loss function.

Description of choice:

Set the required value.

454 Dead time compensation

(DEADTIME COMP.)

Value:

Off (OFF)	[0]
☆ On (ON)	[1]

Function:

The active inverter dead time compensation which is part of the VLT 5000 control algorithm (VVC+) is caus-

ing instability at standstill when working in closed loop control. The purpose of this parameter is switching off the active dead time compensation to avoid instability.

Description of choice:

Select *Off* [0] to inactivate the dead time compensation.

Select *On* [1] to activate the dead time compensation.

455 Frequency range monitor (MON. FREQ. RANGE)

Value:

- Disable [0]
- ★ Enable [1]

Function:

his parameter is used if warning 35 *Out of frequency range* must be turned off in the display in process control closed loop. This parameter does not affect the extended status word.

Description of choice:

Select *Enable* [1] to enable the readout in the display if warning 35 *Out of frequency range* occurs. Select *Disable* [0] to disable the readout in the display if warning 35 *ut of frequency range* occurs.

457 Phase loss function (Phase loss funct)

Value:

- ★ Trip (Trip) [0]
- Warning (Warning) [1]

Function:

Select the function which is to be activated if the mains imbalance becomes too high or if a phase is missing.

Description of choice:

At *Trip* [0] the frequency converter will stop the motor within a few seconds (depending on drive size).

At *Warning* [1] only a warning will be exported when a mains failure occurs, but in severe cases, other extreme conditions might result in a trip.



NB!

If *Warning* has been selected, the life expectancy of the drive will be reduced when the mains failure persists.



NB!

At phase loss, the internal cooling fans of some drive types cannot be powered. In order to avoid overheating, an external power supply can be connected.

IP00/IP20/NEMA

- VLT 5032-5052, 200-240 V

- VLT 5122-5552, 380-500 V

- VLT 5042-5602, 525-690 V

- IP54

- VLT 5006-5052, 200-240 V

- VLT 5016-5552, 380-500 V

- VLT 5042-5602, 525-690 V

See also *Electrical Installation*.

483 Dynamic DC link compensation (DC link comp.)

Value:

- Off [0]
- ★ On [1]

Function:

The frequency converter includes a feature, which ensures that the output voltage is independent of any voltage fluctuation in the DC link, e.g. caused by fast fluctuation in the mains supply voltage. The benefit is a very steady torque on motor shaft (low torque ripple) under most mains conditions.

Description of choice:

In some cases this dynamic compensation can cause resonance's in the DC link and should then be disabled. Typical cases are where a line choke or a passive harmonic filter (e.g. filters AHF005/010) is mounted in the mains supply to the frequency converter to suppress harmonics. Can also occur on mains with low short circuit ratio.

Parameters - Serial communication

500	Address
(BUS ADDRESS)	

Value:

- Parameter 500 Protocol = FC protocol [0] ☆ 1
- 0 - 126
- Parameter 500 Protocol = MODBUS RTU [2] ☆ 1
- 1 - 247

Function:

This parameter allows the allocation of an address to each frequency converter in a serial communication network.

Description of choice:

The individual frequency converter must be allocated a unique address.

If the number of units connected (frequency converters + master) is higher than 31, a repeater must be used. Parameter 500 *Address* cannot be selected via the serial communication, but must be preset via the control unit.

501	Baudrate
(BAUDRATE)	

Value:

- 300 Baud (300 BAUD) [0]
- 600 Baud (600 BAUD) [1]
- 1200 Baud (1200 BAUD) [2]
- 2400 Baud (2400 BAUD) [3]
- 4800 Baud (4800 BAUD) [4]
- ☆ 9600 Baud (9600 BAUD) [5]

Function:

This parameter is for programming the speed at which data is to be transmitted via the serial connection. Baud rate is defined as the number of bits transferred per second.

Description of choice:

The transmission speed of the frequency converter is to be set at a value that corresponds to the transmission speed of the PLC/PC. Parameter 501 cannot be selected via the serial port, RS 485. The data transmission time proper, which is determined by the set baud rate, is only part of the total communication time.

502	Coasting
(COASTING SELECT)	

503	Quick-stop
(Q STOP SELECT)	

504	DC-brake
(DC BRAKE SELECT)	

505	Start
(START SELECT)	

507	Selection of Setup
(SETUP SELECT)	

508	Selection of speed
(PRES.REF. SELECT)	

Value:

- Digital input (DIGITAL INPUT) [0]
- Bus (SERIAL PORT) [1]
- Logic and (LOGIC AND) [2]
- ☆ Logic or (LOGIC OR) [3]

Function:

Parameters 502-508 allow a choice between controlling the frequency converter via the terminals (digital input) and/or via the bus.

If *Logic and* or *Bus* is selected, the command in question can only be activated if transmitted via the serial communication port. In the case of *Logic and*, the command must additionally be activated via one of the digital inputs.

Description of choice:

Digital input [0] is selected if the control command in question is only to be activated via a digital input. *Bus* [1] is selected if the control command in question is only to be activated via a bit in the control word (serial communication).

Logic and [2] is selected if the control command in question is only to be activated when a signal is transmitted (active signal = 1) via both a control word and a digital input.

Digital input 505-508	Bus	Control com- mand
0	0	0
0	1	0
1	0	0
1	1	1

Logic or [3] is selected if the control command in question is to be activated when a signal is given (active signal = 1) either via a control word or via a digital input.

☆ = factory setting, () = display text, [] = value for use in communication via serial communication port

Digital input 505-508	Bus	Control com- mand
0	0	0
0	1	1
1	0	1
1	1	1



NB!

Parameters 502-504 deal with stop functions - see examples regarding 502 (coasting) below. Active stop command "0".

Parameter 502 = *Logic and*

Digital input	Bus	Control command
0	0	1 Coasting
0	1	0 Motor running
1	0	0 Motor running
1	1	0 Motor running

Parameter 502 = *Logic or*

Digital input	Bus	Control command
0	0	1 Coasting
0	1	1 Motor running
1	0	1 Motor running
1	1	0 Motor running

506 Reversing

(REVERSING SELECT)

Value:

★ Digital input (DIGITAL INPUT)	[0]
Bus (SERIAL PORT)	[1]
Logic and (LOGIC AND)	[2]
Logic or (LOGIC OR)	[3]

Function:

See description under parameter 502.

Description of choice:

See description under parameter 502.

509 Bus jog 1

(BUS JOG 1 FREQ.)

Value:

0.0 - parameter 202 ★ 10.0 Hz

Function:

This is where to set a fixed speed (jog) that is activated via the serial communication port.

This function is the same as in parameter 213.

Description of choice:

The jog frequency f_{JOG} can be selected in the range between f_{MIN} (parameter 201) and f_{MAX} (parameter 202).

510 Bus jog 2

(BUS JOG 2 FREQ.)

Value:

0.0 - parameter 202 ★ 10.0 Hz

Function:

This is where to set a fixed speed (jog) that is activated via the serial communication port.

This function is the same as in parameter 213.

Description of choice:

The jog frequency f_{JOG} can be selected in the range between f_{MIN} (parameter 201) and f_{MAX} (parameter 202).

512 Telegram profile

(TELEGRAM PROFILE)

Value:

Fieldbus profile (FIELD BUS PROFILE)	[0]
★ FC Drive (FC DRIVE)	[1]

Function:

There is a choice of two different control word profiles.

Description of choice:

Select the desired control word profile.

See *Serial communication*, in the Design Guide for further information about the control word profiles. See also the dedicated fieldbus manuals for further details.

513 Bus time interval

(BUS TIMEOUT TIME)

Value:

1 - 99 sec. ★ 1 sec.

Function:

This parameter sets the maximum time expected to pass between the receipt of two consecutive telegrams. If this time is exceeded, the serial communication port is reset.

tion is assumed to have stopped and the desired reaction is set in parameter 514.

Description of choice:

Set the desired time.

**514 Bus time interval function
(BUS TIMEOUT FUNC)**

Value:

Off (OFF)	[0]
Freeze output (FREEZE OUTPUT)	[1]
Stop (STOP)	[2]
Jogging (JOGGING)	[3]
Max. speed (MAX SPEED)	[4]
Stop and trip (STOP AND TRIP)	[5]

Function:

This parameter selects the desired reaction of the frequency converter when the set time for bus timeout (parameter 513) has been exceeded.

If choices [1] to [5] are activated, relay 01 and relay 04 will be de-activated.

If more time-outs occur at the same time the frequency converter will give the following priority to the time-out function:

1. Parameter 318 *Function after time out*
2. Parameter 346 *Function after encoder loss*
3. Parameter 514 *Bus time interval function*.

Description of choice:

The output frequency of the frequency converter can: be frozen at the present value, be frozen at the reference, go to stop, go to jogging frequency (parameter 213), go to max. output frequency (parameter 202) or stop and activate a trip.

Parameter no.	Description	Display text	Unit	Updating interval
515	Reference %	(REFERENCE)	%	80 msec.
516	Reference Unit	(REFERENCE [UNIT])	Hz, Nm or rpm	80 msec.
517	Feedback	(FEEDBACK)	To be selected via par. 416	80 msec.
518	Frequency	(FREQUENCY)	Hz	80 msec.
519	Frequency x Scaling	(FREQUENCY X SCALE)	-	80 msec.
520	Current	(MOTOR CURRENT)	Amp x 100	80 msec.
521	Torque	(TORQUE)	%	80 msec.
522	Power, kW	(POWER (KW))	kW	80 msec.
523	Power, HP	(POWER (HP))	HP (US)	80 msec.
524	Motor voltage	(MOTOR VOLTAGE)	V	80 msec.
525	DC link voltage	(DC LNK VOLTAGE)	V	80 msec.
526	Motor temp.	(MOTOR THERMAL)	%	80 msec.
527	VLT temp.	(VLT THERMAL)	%	80 msec.
528	Digital input	(DIGITAL INPUT)	Binary code	2 msec.
529	Terminal 53, analogue input	(ANALOG INPUT 53)	V	20 msec.
530	Terminal 54, analogue input	(ANALOG INPUT 54)	V	20 msec.
531	Terminal 60, analogue input	(ANALOG INPUT 60)	mA	20 msec.
532	Pulse reference	(PULSE REFERENCE)	Hz	20 msec.
533	External reference %	(EXT. REFERENCE)		20 msec.
534	Status word	(STATUS WORD [HEX])	Hex code	20 msec.
535	Brake power/2 min.	(BR. ENERGY/2 MIN)	kW	
536	Brake power/sec.	(BRAKE ENERGY/S)	kW	
537	Heat sink temperature	(HEATSINK TEMP.)	°C	1.2 sec.
538	Alarm word	(ALARM WORD [HEX])	Hex code	20 msec.
539	VLT control word	(CONTROLWORD [HEX])	Hex code	2 msec.
540	Warning word, 1	(WARN. WORD 1)	Hex code	20 msec.
541	Extended status word Hex	(EXT. STATUS WORD)	Hex code	20 msec.
557	Motor RPM	(MOTOR RPM)	RPM	80 msec.
558	Motor RPM x scaling	(MOTOR RPM X SCALE)	-	80 msec.

Function:

These parameters can be read out via the serial communication port and via the display in Display mode, see also parameters 009 - 012.

Description of choice:
Reference %, parameter 515:

The value shown corresponds to the total reference (sum of digital/analogue/preset/bus/freeze ref./catch-up and slow-down).

Reference Unit, parameter 516:

Gives the present value of terminals 17/29/53/54/60 in the unit resulting from the choice of configuration in parameter 100 (Hz, Nm or rpm) or in parameter 416. See also parameters 205 and 416, if required.

Feedback, parameter 517:

Indicates the status value of terminals 33/53/60 at the unit/scale selected in parameters 414, 416 and 416.

Frequency, parameter 518:

The value shown corresponds to the actual motor frequency f_M (without resonance dampening).

Frequency x scale, parameter 519:

The value shown corresponds to the actual motor frequency f_M (without resonance dampening) multiplied by a factor (scaling) set in parameter 008.

Motor current, parameter 520:

The value shown corresponds to the given motor current measured as a mean value I_{RMS} .

The value is filtered, which means that approx. 1.3 seconds may pass from an input value changes until the data read-out changes values.

Torque, parameter 521:

★ = factory setting, () = display text, [] = value for use in communication via serial communication port

The value shown is the torque, with sign, supplied to the motor shaft. The value is given as a percentage of the rated torque.

There is not exact linearity between 160% motor current and torque in relation to the rated torque. Some motors supply more torque than that. Consequently, the min. value and the max. value will depend on the max. motor current as well as the motor used.

The value is filtered, which means that approx. 1.3 seconds may pass from an input changes value until the data read-out changes values.



NB!

If the setting of the motor parameters does not match the motor applied, the read-out values will be inaccurate and may become negative, even if the motor is not running or is producing a positive torque.

Power, (kW), parameter 522:

The value shown is calculated on the basis of the actual motor voltage and motor current.

The value is filtered, which means that it may take approx. 1.3 seconds from an input value changes until the data read-out changes values.

Power (HP), parameter 523:

The value shown is calculated on the basis of the actual motor voltage and motor current.

The value is indicated in the form of HP.

The value is filtered, which means that approx. 1.3 seconds may pass from an input value changes until the data read-out changes values.

Motor voltage, parameter 524:

The value shown is a calculated value used for controlling the motor.

DC link voltage, parameter 525:

The value shown is a measured value.

The value is filtered, which means that approx. 1.3 seconds may pass from an input value changes until the data read-out changes values.

Motor temp., parameter 526:

VLT temp., parameter 527:

Only whole numbers are displayed.

Digital input, parameter 528:

The value shown indicates the signal status from the 8 digital terminals (16, 17, 18, 19, 27, 29, 32 and 33).

The read-out is binary and the digit at the extreme left gives the status of terminal 16, while the digit at the extreme right gives the status of terminal 33.

Terminal 53, analogue input, parameter 529:

The value shown indicates the signal value on terminal 53.

The scaling (parameters 309 and 310) does not influence the read-out. Min. and max. are determined by the offset and gain adjustment of the AD-converter.

Terminal 54, analogue input, parameter 530:

The value shown indicates the signal value on terminal 54.

The scaling (parameters 312 and 313) does not influence the read-out. Min. and max. are determined by the offset and gain adjustment of the AD-converter.

Terminal 60, analogue input, parameter 531:

The value shown indicates the signal value on terminal 60.

The scaling (parameters 315 and 316) does not influence the read-out. Min. and max. are determined by the offset and gain adjustment of the AD-converter.

Pulse reference, parameter 532:

The value shown indicates any pulse reference in Hz connected to one of the digital inputs.

External reference %, parameter 533:

The value stated gives, as a percentage, the sum of external references (sum of analogue/bus/pulse).

Status word, parameter 534:

Indicates the status word transmitted via the serial communication port in Hex code from the frequency converter. See the Design Guide.

Brake power/2min., parameter 535:

Indicates the brake power transmitted to an external brake resistor. The mean power is calculated on an ongoing basis for the latest 120 sec.

Brake power/sec., parameter 536:

Indicates the given brake power transmitted to an external brake resistor. Stated as an instantaneous value.

Heat sink temperature, parameter 537:

States the given heat sink temperature of the frequency converter. The cut-out limit is $90 \pm 5^\circ\text{C}$, while the unit cuts back in at $60 \pm 5^\circ\text{C}$.

Alarm word, parameter 538:

States in Hex format whether there is an alarm on the frequency converter. See section *Warning word 1, Extended status word and Alarm word for further information*.

VLT control word, parameter 539:

Gives the control word sent via the serial communication port in Hex code to the frequency converter. See the *Design Guide* for further information.

Warning word, 1, parameter 540:

States in Hex format whether there is a warning on the frequency converter. See section *Warning word 1, Extended status word and Alarm word for further information.*

Extended status word Hex, parameter 541:

States in Hex format whether there is a warning on the frequency converter.

See section *Warning word 1, Extended status word and Alarm word for further information.*

Motor RPM, parameter 557:

The displayed value corresponds to the actual motor RPM. In open loop or closed loop process control, the motor RPM is estimated. In speed closed loop modes, it is measured.

Motor RPM x scaling, parameter 558:

The displayed value corresponds to the actual motor RPM multiplied by a factor (scaling) set in parameter 008.

561	Protocol	
	(PROTOCOL)	
Value:		
☆	FC protocol (FC PROTOKOL)	[0]
	Modbus RTU	[3]

Function:
There is a choice of two different protocols.

Description of choice:
Select the required control word protocol.

For further information about using the Modbus RTU see MG10SX.

570	Modbus parity and message framing	
	(M.BUS PAR./FRAME)	
Value:		
	(EVEN/1 STOPBIT)	[0]
	(ODD/1 STOPBIT)	[1]
☆	(NO PARITY/1 STOPBIT)	[2]
	(NO PARITY/2 STOPBIT)	[3]

Function:
This parameter sets up the drive's Modbus RTU interface to communicate properly with the master control-

ler. The parity (EVEN, ODD, or NO PARITY) must be set to match the setting of the master controller.

Description of choice:

Select the parity that matches the setting for the Modbus master controller. Even or odd parity is sometimes used to allow a transmitted word to be checked for errors. Because Modbus RTU uses the more efficient CRC (Cyclic Redundancy Check) method of checking for errors, parity checking is seldom used in Modbus RTU networks.

571 Modbus communications timeout (M.BUS COM.TIME.)

Value:
10 ms - 2000 ms ☆ 100 ms

Function:
This parameter determines the maximum amount of time that the drive's Modbus RTU will wait between characters that are sent by the master controller. When this amount of time expires, the drive's Modbus RTU interface will assume that it has received the entire message.

Description of choice:

Generally, the value of 100 ms is sufficient for Modbus RTU networks, although some Modbus RTU networks may operate on a timeout value as short as 35 ms. If this value is set too short, the drive's Modbus RTU interface may miss a part of the message. Since the CRC check will not be valid, the drive will ignore the message. The resulting retransmissions of messages will slow communications on the network. If this value is set too long, the drive will wait longer than necessary to determine that the message is completed. This will delay the drive's response to the message and possibly cause the master controller to time out. The resulting retransmissions of messages will slow communications on the network.

☆ = factory setting, () = display text, [] = value for use in communication via serial communication port

■ LCP procedure for entering text

After selecting *Display Text* in parameter 009 and 010, select display line parameter (553 or 554) and press the **CHANGE DATA** key. Enter text directly into the selected line by using **UP, DN & LEFT, RIGHT** arrow keys on the LCP. The UP and DN arrow keys scroll through the available characters. The Left and Right arrow keys move the cursor through the line of text.

To lock in the text, press the **OK** key when the line of text is completed. The **CANCEL** key will cancel the text.

The available characters are:

A B C D E F G H I J K L M N O P Q R S T U V W X Y
Z Æ Ø Å Ä Ö Ü È Ì Ù è . / - () 0 1 2 3 4 5 6 7 8 9 'space'

'space' is the default value of parameter 553 & 554. To erase a character that has been entered, it must be replaced with 'space'.

553 Display text 1 (DISPLAY TEXT ARRAY 1)

Value:

Max. 20 characters [XXXXXXXXXXXXXXXXXXXXX]

Function:

Here, a text of max. 20 characters can be written that will be shown in display line 1, provided *LCP display text* [27] has been selected in parameter 010 *Display line 1.1*. Example of display text:

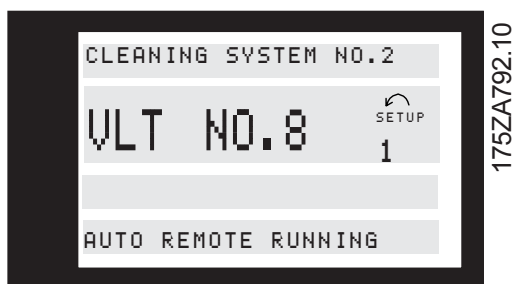

Description of choice:

The required text can be written via serial communication or by means of the arrow keypads on the LCP.

554 Display text 2 (DISPLAY TEXT ARRAY 2)

Value:

Max. 8 characters [XXXXXXXX]

Function:

Here, a text of max. 8 characters can be written that will be shown in display line 2, provided *LCP Display Text* [29] has been selected in parameter 009 *Display line 2*

Description of choice:

The required text can be written via serial communication or by means of the arrow keypads on the LCP.

580–582 Defined parameters

(DEFINED PARAM.)

Value:

Read only

Function:

The three parameters contain a list of all parameters defined in the VLT. Each parameter contains up to 116 elements (parameter numbers). The number of parameters that are in use (580, 581, 582) depends on the respective VLT configuration. When a 0 is used as a parameter number, the list ends.

Description of choice:

■ Parameters - Technical functions and diagnostics

Parameter no.	Description	Display text	Unit	Range
Operating data				
600	Operating hours	(OPERATING HOURS)	Hours	0 - 130,000.0
601	Hours run	(RUNNING HOURS)	Hours	0 - 130,000.0
602	kWh counter	(KWH COUNTER)	kWh	0 - 9999
603	No. of cut-ins	(POWER UP's)	Nos.	0 - 9999
604	No. of overtemps	(OVER TEMP's)	Nos.	0 - 9999
605	No. of overvoltages	(OVER VOLT'S)	Nos.	0 - 9999

Function:

These parameters can be read out via the serial communication port and via the display in the parameters.

Description of choice:

Operating hours, **parameter 600:**

Indicates the number of hours in which the frequency converter has been in operation.

The value is updated in the frequency converter every hour and saved when the unit is turned off.

Hours run, parameter 601:

Indicates the number of hours in which the frequency converter has been in operation since reset in parameter 619.

The value is updated in the frequency converter every hour and saved when the unit is turned off.

kWh counter, **parameter 602:**

States the power consumption from mains in kWh as a mean value over one hour. Reset counter: Parameter 618.

No. of cut-ins, parameter 603:

States the number of power-ups of the supply voltage to the frequency converter.

No. of overtemps, parameter 604:

States the number of temperature faults there has been on the frequency converter.

No. of overvoltages, parameter 605:

States the number of overvoltages there has been on the frequency converter.

Parameter no.	Description	Display text	Unit	Range
Data log				
606	Digital inputs	(LOG: DIGITAL INP)	Decimal	0 - 255
607	Control word	(LOG: CONTROL WORD)	Decimal	0 - 65535
608	Status word	(LOG: BUS STAT WD)	Decimal	0 - 65535
609	Reference	(LOG: REFERENCE)	%	0 - 100
610	Feedback	(LOG: FEEDBACK)	Par. 416	999,999.99 - 999,999.99
611	Output frequency	(LOG: MOTOR FREQ.)	Hz.	0.0 - 999.9
612	Output voltage	(LOG: MOTOR VOLT)	Volt	50 - 1000
613	Output current	(LOG: MOTOR CURR.)	Amp	0.0 - 999.9
614	DC link voltage	(LOG: DC LINK VOLT)	Volt	0.0 - 999.9

Function:

Via this parameter it is possible to see up to 20 data-logs, where [0] is the latest log and [19] the oldest.

Each data-log is made every 160 ms as long as a start signal has been given. If a stop signal is given, the latest 20 data-logs will be saved and the values will be available on the display. This is useful, e.g. when carrying out service after a trip.

This parameter can be read out via the serial communication port or via the display.

Description of choice:

The data-log number is stated in square brackets: [1]. Data-logs are frozen if there is a trip and released when the frequency converter is subsequently reset. Data-logging is active while the motor is running.

Free a data-log if there is a trip and release it when resetting the frequency converter. Data-logging is active when the motor is running.

Digital inputs, parameter 606:

The value for the digital inputs is given as a decimal figure within the range of 0-255.

The data-log number is stated in square brackets: [1]

★ = factory setting, () = display text, [] = value for use in communication via serial communication port

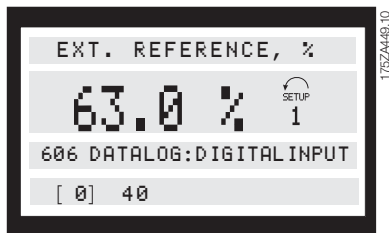

Control word, parameter 607:

The value for the control word is given as a decimal figure within the range of 0-65535.

Status word, parameter 608:

The value for the bus status word is given as a decimal figure within the range of 0-65535.

Reference, parameter 609:

The value of the reference is stated as a % in the interval 0 - 100%.

Feedback, parameter 610:

The value is stated as the parameterised feedback.

Output frequency, parameter 611:

The value of the motor frequency is stated as a frequency in the interval 0.0 - 999.9 Hz.

Output voltage, parameter 612:

The value of the motor voltage is stated as Volts in the interval 50 - 1000 V.

Output current, parameter 613:

The value for the motor current is stated as Amps in the interval 0.0 - 999.9 A.

DC link voltage, parameter 614:

The value of the DC link voltage is stated as Volts in the interval 0.0 - 999.9 V.

615 Fault log: Error code

(F.LOG: ERROR COD)

Value:

[Index 1 - 10] Error code 0 - 44

Function:

This parameter makes it possible to see the reason why a trip occurs.

10 (0-10) log values are stored.

The lowest log number (1) contains the latest/most recently saved data value; the highest log number (10) contains the oldest data value.

Description of choice:

Given as a number code in which the trip number refers to an alarm code that can be seen in the table in section *Warnings and Alarms*.

Reset the fault log after manual initialisation.

616 Fault log: Time

(F.LOG: TIME)

Value:

[Index 1 - 10]

Function:

This parameter makes it possible to see the total number of operating hours before the trip occurred. 10 (0-10) log values are stored.

The lowest log number [1] contains the latest/most recently saved data value, while the highest log number [10] contains the oldest data value.

Description of choice:

Read out as an option.

Indication range: 0.0 - 9999.9.

Reset the fault log after manual initialisation.

617 Fault log: Value

(F.LOG: VALUE)

Value:

[Index 1 - 10]

Function:

This parameter makes it possible to see at what current or voltage a given trip occurred.

Description of choice:

Read out as one value.

Indication range: 0.0 - 999.9.

Reset the fault log after manual initialisation.

618 Reset of kWh counter

(RESET KWH COUNT)

Value:

No reset (DO NOT RESET) [0]

Reset (RESET COUNTER) [1]

Function:

Reset to zero of kWh hour counter (parameter 602).

Description of choice:

If *Reset* [1] has been selected and when the [OK] key is pressed, the kWh counter of the frequency converter

is reset. This parameter cannot be selected via the serial port, RS 485.



NB!

When the [OK] key has been activated, the reset has been carried out.

619 Reset of hours-run counter (RESET RUN. HOUR)

Value:

- No reset (DO NOT RESET) [0]
- Reset (RESET COUNTER) [1]

Function:

Reset to zero of hours-run counter (parameter 601).

Description of choice:

If *Reset* [1] has been selected and when the [OK] key is pressed, the hours-run counter of the frequency converter is reset. This parameter cannot be selected via the serial port, RS 485.



NB!

When the [OK] key has been activated, the reset has been carried out.

620 Operating mode (OPERATION MODE)

Value:

- ★ Normal function (NORMAL OPERATION) [0]
- Function with de-activated inverter (OPER. W/INVERT.DISAB) [1]
- Control card test (CONTROL CARD TEST) [2]
- Initialisation (INITIALIZE) [3]

Function:

In addition to its normal function, this parameter can be used for two different tests. Also, all parameters (except parameters 603-605) can be initialised.



NB!

This function will not become active until the mains supply to the frequency converter has been turned off and then turned on again.

Description of choice:

Normal function [0] is selected for normal operation with the motor in the selected application.

Function with deactivated inverter [1] is selected if control is desired over the influence of the control signal over the control card and its functions - without the inverter driving the motor.

Control card test [2] is selected if control of the analogue and digital inputs, as well as the analogue, digital relay outputs and the +10 V control voltage is desired. A test connector with internal connections is required for this test.

Use the following procedure for the control card test:

1. Select *Control card test*.
2. Cut off the mains supply and wait for the light in the display to go out.
3. Insert the test plug (see below).
4. Connect to mains.
5. The frequency converter expects the [OK] key to be pressed (if no LCP, set to *Normal operation*, when the frequency converter will start up as usual).
6. Carry out various tests.
7. Press the [OK] key.
8. Parameter 620 is automatically set to *Normal operation*.

If a test fails, the frequency converter will move into an infinite loop. Replace control card.

Test plugs:

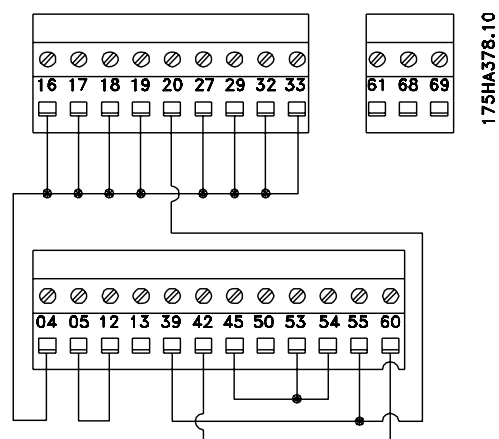

Initialisation [3] is selected if the factory setting of the unit is desired without resetting parameters 500, 501 + 600 - 605 + 615 - 617.

★ = factory setting, () = display text, [] = value for use in communication via serial communication port



NB!

The motor must be stopped before initialisation can be carried out.

Procedure for initializing:

1. Select Initialisation.
2. Press the [OK] key.
3. Cut off the mains supply and wait for the light in the display to go out.
4. Connect to mains.

Manual initialisation can be carried out by holding down three keys at the same time as the mains voltage is connected. Manual initialisation sets all parameters to the factory setting, except 600-605. The procedure for manual initialisation is as follows:

1. Disconnect the mains voltage and wait for the light in the display to disappear.
2. Hold down [DISPLAY/STATUS]+[MENU]+[OK] while at the same time connecting the mains supply. The display will now read MANUAL INITIALIZE.
3. When the display reads UNIT READY, the frequency converter has been initialized.

Parameter no.	Description Nameplate	Display text
621	VLT type	(VLT TYPE)
622	Power section	(POWER SECTION)
623	VLT ordering number	(VLT ORDERING NO)
624	Software version number	(SOFTWARE VERSION)
625	LCP identification number	(LCP ID NO)
626	Database identification number	(PARAM DB ID)
627	Power section identification number	(POWER UNIT DB ID)
628	Application option type	(APP. OPTION)
629	Application option ordering number	(APP. ORDER NO)
630	Communication option type	(COM. OPTION)
631	Communication option ordering number	(COM. ORDER NO)

Function:

The key data of the unit can be read out via the display or the serial communication port.

Description of choice:

VLT type, **parameter 621:**

VLT Type indicates the unit size and basic function concerned.

For example: VLT 5008 380-500 V.

Power section, parameter 622:

The power section states the given power section being used.

For example: Extended with brake.

VLT ordering number, **parameter 623:**

Ordering number gives the ordering number of the VLT type in question.

For example: 175Z0072.

Software version **number, parameter 624:**

Software version gives the version number.

For example: V 3,10.

LCP identification **number, parameter 625:**

The key data of the unit can be read out via the display or the serial communication port.

For example: ID 1,42 2 kB.

Database identification number, parameter 626:

The key data of the unit can be read out via the display or the serial communication port.

For example: ID 1,14.

Power section identification number, parameter 627:

The key data of the unit can be read out via the display or the serial communication port.

For example: ID 1,15.

Application option **type, parameter 628:**

This gives the type of application options fitted with the frequency converter.

Application option ordering number, parameter 629:

This gives the ordering number for the application option.

Communication option **type, parameter 630:**

This gives the type of communication options fitted with the frequency converter

Communication option ordering number, parameter 631:

This gives the ordering number for the communication option.



NB!

Parameters 700-711 for the relay card are only activated if a relay option card is installed in the VLT 5000.

700	Relay 6, function
	(RELAY6 FUNCTION)
703	Relay 7, function
	(RELAY7 FUNCTION)
706	Relay 8, function
	(RELAY8 FUNCTION)
709	Relay 9, function
	(RELAY9 FUNCTION)

Function:

This output activates a relay switch. Relay outputs 6/7/8/9 can be used for showing status and warnings. The relay is activated when the conditions for the relevant data values have been fulfilled. Activation/deactivation can be programmed in parameters 701/704/707/710 *Relay 6/7/8/9, ON delay* and parameters 702/705/708/711 *Relay 6/7/8/9, OFF delay*.

Description of choice:

For data choice and connections see parameter 319 - 326.

701	Relay 6, ON delay
	(RELAY6 ON DELAY)
704	Relay 7, ON delay
	(RELAY7 ON DELAY)
707	Relay 8, ON delay
	(RELAY8 ON DELAY)
710	Relay 9, ON delay
	(RELAY9 ON DELAY)

Value:

0 - 600 sec. ★ 0 sec.

Function:

This parameter allows a delay of the cut-in time of relays 6/7/8/9 (terminals 1-2).

Description of choice:

Enter the required value.

702	Relay 6, OFF delay
	(RELAY6 OFF DELAY)
705	Relay 7, OFF delay
	(RELAY7 OFF DELAY)
708	Relay 8, OFF delay
	(RELAY8 OFF DELAY)
711	Relay 9, OFF delay
	(RELAY9 OFF DELAY)

Value:

0 - 600 sec. ★ 0 sec.

Function:

This parameter is used to delay the cut-out time of relays 6/7/8/9 (terminals 1-2).

Description of choice:

Enter the required value.

■ **Electrical installation of the relay card**

The relays are connected as shown below.

Relay 6-9:

A-B make, A-C break

Max. 240 V AC, 2 Amp.

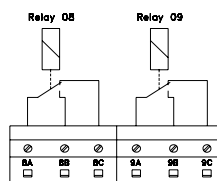
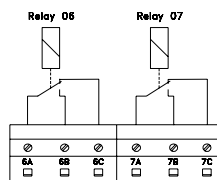

175HA475.10

To achieve double isolation, the plastic foil must be mounted as shown in the drawing below.

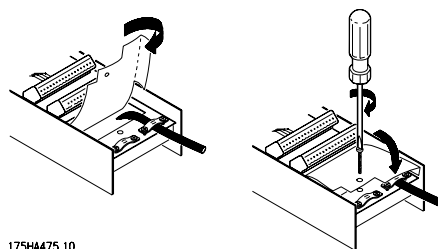

175HA475.10

★ = factory setting, () = display text, [] = value for use in communication via serial communication port

Outputs	terminal no. parameter	Relay 06 700	Relay 07 703	Relay 08 706	Relay 09 709
Value:					
No function	(NO OPERATION)	[0]	[0]	[0]	[0]
Control ready	(CONTROL READY)	[1]	[1]	[1]	[1]
Ready signal	(UNIT READY)	[2] ★	[2]	[2]	[2]
Ready - remote control	(UNIT READY/REM CTRL)	[3]	[3]	[3]	[3]
Enable, no warning	(ENABLE/NO WARNING)	[4]	[4]	[4]	[4]
Running	(VLT RUNNING)	[5]	[5]	[5]	[5]
Running, no warning	(RUNNING/NO WARNING)	[6]	[6]	[6]	[6]
Running within range, no warning	(RUN IN RANGE/NO WARN)	[7]	[7]	[7]	[7]
Running at reference value, no warning	(RUN ON REF/NO WARN)	[8]	[8]	[8]	[8]
Fault	(ALARM)	[9]	[9]	[9]	[9] ★
Fault or warning	(ALARM OR WARNING)	[10]	[10]	[10]	[10]
Torque limit	(TORQUE LIMIT)	[11]	[11]	[11]	[11]
Out of current range	(OUT OF CURRENT RANGE)	[12]	[12]	[12]	[12]
Over I low	(ABOVE CURRENT, LOW)	[13]	[13]	[13]	[13]
Under I high	(BELOW CURRENT, HIGH)	[14]	[14]	[14]	[14]
Out of frequency range	(OUT OF FREQ RANGE)	[15]	[15]	[15]	[15]
Over f low	(ABOVE FREQUENCY LOW)	[16]	[16]	[16]	[16]
Under f high	(BELOW FREQUENCY HIGH)	[17]	[17]	[17]	[17]
Out of feedback range	(OUT OF FDBK RANGE)	[18]	[18]	[18]	[18]
Over feedback low	(ABOVE FDBK, LOW)	[19]	[19]	[19]	[19]
Under feedback high	(BELOW FDBK, HIGH)	[20]	[20]	[20]	[20]
Thermal warning	(THERMAL WARNING)	[21]	[21]	[21]	[21]
Ready - no thermal warning	(READY &NOTHERM WARN)	[22]	[22]	[22]	[22]
Ready - remote control - no therm. warn.	(REM RDY&NO THERMWAR)	[23]	[23]	[23]	[23]
Ready - mains voltage within range	(RDY NO OVER/UNDERVOL)	[24]	[24]	[24]	[24]
Reversing	(REVERSE)	[25]	[25]	[25]	[25]
Bus ok	(BUS OK)	[26]	[26]	[26]	[26]
Torque limit and stop	(TORQUE LIMIT AND STOP)	[27]	[27]	[27]	[27]
Brake, no brake warning	(BRAKE NO WARNING)	[28]	[28]	[28]	[28]
Brake ready, no fault	(BRAKE RDY (NO FAULT))	[29]	[29]	[29]	[29]
Brake fault	(BRAKE FAULT (IGBT))	[30]	[30]	[30]	[30]
Relay 123	(RELAY 123)	[31]	[31]	[31]	[31]
Mechanical brake control	(MECH. BRAKE CONTROL)	[32]	[32]	[32]	[32]
Control word bit 11/12	(CTRL WORD BIT 11/12)	[33]	[33]	[33]	[33]
Extended mechanical brake control	(EXT. MECH. BRAKE)	[34]	[34]	[34]	[34]
Safety interlock	(SAFETY INTERLOCK)	[35]	[35]	[35]	[35]
Mains ON	(MAINS ON)	[50]	[50]	[50] ★	[50]
Motor running	(MOTOR RUNNING)	[51]	[51] ★	[51]	[51]

Function:
Description of choice:

For description of choice please see parameter 319.

Mains ON [50], has the same logical function as *Running* [5].

Motor running [51], has the same logical function as *Mechanical brake control* [32]

■ Trouble-shooting

Symptom	How to handle
1. Motor runs unevenly	<p>If the motor runs unevenly, but no fault is given, this may be because the frequency converter has been wrongly set. Adjust the motor data settings. Contact Danfoss if the new setting does not make the motor run evenly.</p>
2. Motor does not run	<p>Check if there is a backlight in the display. If there is a backlight, please check if a fault message is displayed. If yes, please consult the <i>Warnings-section</i>, if no, please refer to symptom 5. If there is no backlight, check if the frequency converter is connected to mains supply. If yes, please refer to symptom 4.</p>
3. Motor does not brake	<p>Please refer to <i>Control with brake function</i>.</p>
4. No message or backlight in display	<p>Check if the prefuses for the frequency converter have blown. If yes, call Danfoss for assistance. If no, check if the control card is overloaded. If so, disconnect all control signal plugs on the control card and check if the fault disappears. If yes, make sure that the 24 V supply is not short-circuited. If no, call Danfoss for assistance.</p>
5. Motor stopped, light in display, but no fault report	<p>Start the frequency converter by pressing [START] on the control panel. Check if the display is frozen, ie. the display cannot be changed or is undefineable. If yes, check if screened cables have been used and are connected correctly. If no, check that the motor is connected and that all motor phases are OK. The frequency converter must be set to run using local references: Parameter 002 = Local operation Parameter 003 = desired reference value Connect 24 V DC to terminal 27. The reference is changed by pressing '+' or '-'. Is the motor running? If yes, check whether control signals to the control card are OK. If no, call Danfoss for assistance.</p>

■ Display - Status messages

Status messages appear in the 4th line of the display, see the below example. The status message will be on the display for approx. 3 seconds.

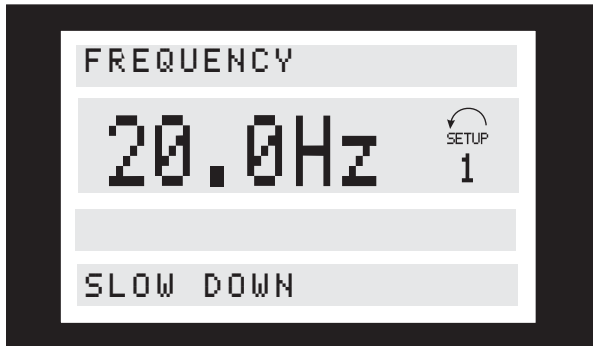
Start clockwise/anti-clockwise (START FORW./REV):

Input on digital inputs and parameter data are in conflict.

Slow-down (SLOW DOWN):

The output frequency of the frequency converter is reduced by the percentage value chosen in parameter 219.

Catch-up (CATCH UP):

The output frequency of the frequency converter is increased by the percentage value chosen in parameter 219.

Feedback high (FEEDBACK HIGH):

The FB value is higher than the value set in parameter 228. This message is only shown when the motor is running.

Feedback low (FEEDBACK LOW):

The FB value is lower than the value set in parameter 227. This message is only shown when the motor is running.

Output frequency high (FREQUENCY HIGH):

The output frequency is higher than the value set in parameter 226. This message is only shown when the motor is running.

Output frequency low (FREQUENCY LOW):

The output frequency is lower than the value set in parameter 225. This message is only shown when the motor is running.

Output current high (CURRENT HIGH):

The output current is higher than the value set in parameter 224. This message is only shown when the motor is running.

Output current low (CURRENT LOW):

The output current is lower than the value set in parameter 223. This message is only shown when the motor is running.

Braking max. (BRAKING MAX):

The brake is functioning. Optimum braking is effected when the value in parameter 402 *Braking power limit, KW* is exceeded.

Braking (BRAKING):

The brake is functioning.

Ramp operation (REM/ RAMPING):

Remote has been selected in parameter 002 and the output frequency is changed in accordance with the ramps set.

Ramp operation (LOCAL/ RAMPING):

Local has been selected in parameter 002 and the output frequency is changed in accordance with the ramps set.

Running, local control (LOCAL/RUN OK):

Local control has been selected in parameter 002 and a start command is given on either terminal 18 (START or LATCHED START in parameter 302) or terminal 19 (START REVERSE parameter 303).

Running, remote control (REM/RUN OK):

Remote control has been selected in parameter 002 and a start command is given on either terminal 18 (START or LATCHED START in parameter 302), terminal 19 (START REVERSE parameter 303) or via the serial bus.

VLT ready, remote control (REM/UNIT READY):

Remote control has been selected in parameter 002 and *Coasting stop inverse* in parameter 304, and there is 0 V on terminal 27.

VLT ready, local control (LOCAL/ UNIT READY):

Local has been selected in parameter 002 and *Coasting inverse* in parameter 304, and there is 0 V on terminal 27.

Quick-stop, remote control (REM/QSTOP):

Remote control has been selected in parameter 002 and the frequency converter has stopped via a quick-stop signal on terminal 27 (or possibly via the serial communication port).

Quick-stop, local (LOCAL/ QSTOP):

Local has been selected in parameter 002 and the frequency converter has stopped via a quick-stop signal on terminal 27 (or possibly via the serial communication port).

DC stop, remote control (REM/DC STOP):

Remote control has been selected in parameter 002 and the frequency converter has stopped via a DC stop signal on a digital input (or possibly via the serial communication port).

DC braking, local (LOCAL/ DC STOP):

Local has been selected in parameter 002 and the frequency converter has stopped via a DC braking signal on terminal 27 (or possibly via the serial communication port).

Stop, remote controlled (REM/STOP):

Remote control has been selected in parameter 002 and the frequency converter has stopped via the control panel or a digital input (or possibly via the serial communication port).

Stop, local (LOCAL/ STOP):

Local has been selected in parameter 002 and the frequency converter has stopped via the control panel or the digital input (or possibly via the serial communication port).

LCP stop, remote (REM/LCP STOP):

Remote has been selected in parameter 002 and the frequency converter has via the control panel. The coast signal on terminal 27 is high.

LCP stop, local (LOCAL/LCP STOP):

Local has been selected in parameter 002 and the frequency converter has stopped via the control panel. The coast signal on terminal 27 is high.

Stand by (STAND BY):

Remote control has been selected in parameter 002. The frequency converter will start when it receives a start signal via a digital input (or the serial communication port).

Freeze output (FREEZE OUTPUT):

Remote control has been selected in parameter 002 together with *Freeze reference* in parameter 300, 301, 305, 306 or 307, and the terminal in question (16, 17, 29, 32 or 33) has been activated (or possibly via the serial communication port).

Jog operation, remote controlled (REM/RUN JOG):

Remote control has been selected in parameter 002 and *Jog* in parameter 300, 301, 305, 306 or 307, and the terminal in question (16, 17, 29, 32 or 33) has been activated (or possibly via the serial communication port).

Jog operation, local (LOCAL/ RUN JOG):

Local has been selected in parameter 002 and *Jog* in parameter 300, 301, 305, 306 or 307, and the terminal in question (16, 17, 29, 32 or 33) has been activated (or possibly via the serial communication port).

Overvoltage control (OVER VOLTAGE CONTROL):

The intermediate circuit voltage of the frequency converter is too high. The frequency converter is trying to avoid a trip by increasing the output frequency. This function is activated in parameter 400.

Automatic Motor Adaptation (AUTO MOTOR ADAPT):

Automatic Motor adaptation is running.

Brake check finished (BRAKECHECK OK):

Brake check of brake resistor and brake transistor tested successfully.

Quick Discharge finished (QUICK DISCHARGE OK):

Quick discharge has been completed successfully.

Exceptions XXXX (EXCEPTIONS XXXX):

The microprocessor of the control card has stopped and the frequency converter is out of operation. The cause may be noise on the mains, motor or control cables, leading to a stop of the control card microprocessor. Check for EMC-correct connection of these cables.

Ramp stop in fieldbus mode (OFF1):

OFF1 means that the drive is stopped by ramp down. The command to stop has been given over a fieldbus or the RS485 serial port (select fieldbus in parameter 512).

Coast stop in fieldbus mode (OFF2):

OFF2 means that the drive is stopped by coast. The command to stop has been given over a fieldbus or the RS485 serial port (select fieldbus in parameter 512).

Quick stop in fieldbus mode (OFF3):

OFF3 means that the drive is stopped by quick stop. The command to stop has been given over a fieldbus or the RS485 serial port (select fieldbus in parameter 512).

Start not possible (START INHIBIT):

The drive is in fieldbus profile mode. OFF1, OFF2 or OFF3 have been activated. OFF1 must be toggled to be able to start (OFF1 set from 1 to 0 to 1).

Not ready for operation (UNIT NOT READY):

The drive is in Fieldbus profile mode (parameter 512). The drive is not ready for operation as bit 00, 01 or 02 in the control word is "0", the drive has tripped or there is no mains supply (only seen on units with 24 V DC supply).

Ready for operation (CONTROL READY):

The drive is ready for operation. For extended units supplied with a 24 V DC supply the message also comes up when there is not mains supply.

Bus jog, remote controlled (REM/RUN BUS JOG1):

Remote control has been selected in parameter 002 and the Fieldbus has been selected in parameter 512. Bus Jog has been selected by the fieldbus or serial bus.

Bus jog, remote controlled (REM/RUN BUS JOG2):

Remote control has been selected in parameter 002 and Fieldbus has been selected in parameter 512. Bus Jog has been selected by the fieldbus or serial bus.

■ Warnings and alarms

The table gives the different warnings and alarms and indicates whether the fault locks the frequency converter. After Trip locked, the mains supply must be cut and the fault must be corrected. Reconnect the mains supply and reset the frequency converter before being ready.

Wherever a cross is placed under both Warning and Alarm, this can mean that a warning precedes the alarm. It can also mean that it is possible to program whether a given fault is to result in a warning or an alarm. This is possible, e.g. in parameter 404 *Brake check*. After a trip, alarm and warning will flash, but if the fault is removed, only alarm will flash. After a reset, the frequency converter will be ready to start operation again.

No.	Description	Warning	Alarm	Trip locked
1	10 Volts low (10 VOLT LOW)	X		
2	Live zero fault (LIVE ZERO ERROR)	X	X	
3	No motor (NO MOTOR)	X		
4	Phase fault (MAINS PHASE LOSS)	X	X	X
5	Voltage warning high (DC LINK VOLTAGE HIGH)	X		
6	Voltage warning low (DC LINK VOLTAGE LOW)	X		
7	Overvoltage (DC LINK OVERVOLT)	X	X	
8	Undervoltage (DC LINK UNDERVOLT)	X	X	
9	Inverter overladed (INVERTER TIME)	X	X	
10	Motor overloaded (MOTOR TIME)	X	X	
11	Motor thermistor (MOTOR THERMISTOR)	X	X	
12	Torque limit (TORQUE LIMIT)	X	X	
13	Overcurrent (OVERCURRENT)	X	X	X
14	Earth fault (EARTH FAULT)		X	X
15	Switch mode fault (SWITCH MODE FAULT)		X	X
16	Short-circuit (CURR.SHORT CIRCUIT)		X	X
17	Standard bus timeout (STD BUS TIMEOUT)	X	X	
18	HPFB bus timeout (HPFB TIMEOUT)	X	X	
19	Fault in EEprom on power card (EE ERROR POWER CARD)	X		
20	Fault in EEprom on conrol card (EE ERROR CTRL. CARD)	X		
21	Auto-optimisation OK (AUTO MOTOR ADAPT OK)		X	
22	Auto-optimisation not OK (AUTO MOT ADAPT FAIL)		X	
23	Brake test failed (BRAKE TEST FAILED)	X	X	
25	Brake resistor short-circuited (BRAKE RESISTOR FAULT)	X		
26	Brake resistor power 100% (BRAKE POWER 100%)	X	X	
27	Brake transistor short-circuited (BRAKE IGBT FAULT)	X		
29	Heat-sink temperature too high (HEAT SINK OVER TEMP.)		X	X
30	Motor phase U missing (MISSING MOT.PHASE U)		X	
31	Motor phase V missing (MISSING MOT.PHASE V)		X	
32	Motor phase W missing (MISSING MOT.PHASE W)		X	
33	Quick discharge not OK (QUICK DISCHARGE FAIL)		X	X
34	Profibus communication fault (PROFIBUS COMM. FAULT)	X	X	
35	Out of frequency range (OUT FREQ RNG/ROT LIM)	X		
36	Mains failure (MAINS FAILURE)	X	X	
37	Inverter fault (INVERTER FAULT)		X	X
39	Check parameters 104 and 106 (CHECK P.104 & P.106)	X		
40	Check parameters 103 and 105 (CHECK P.103 & P.105)	X		
41	Motor too big (Motor too big)	X		
42	Motor too small (Motor too small)	X		
43	Brake fault (BRAKE FAULT)		X	X
44	Encoder loss (ENCODER FAULT)	X	X	
57	Overcurrent (OVERCURRENT)	X	X	X
60	Safety stop (EXTERNAL FAULT)		X	X

■ Warnings

The display flashes between normal state and warning. A warning comes up on the first and second line of the display. See examples below. If parameter 027 is set to line 3/4, the warning will be shown in these lines if the display is in read-out state 1-3.

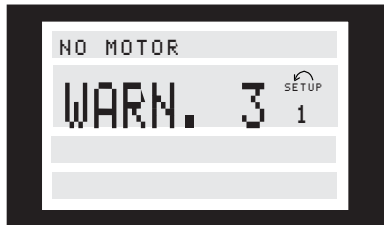

Alarm messages

The alarm comes up in the 2. and 3. line of the display, see example below:



WARNING 1

Under 10 Volts (10 VOLT LOW):

The 10 Volts voltage from terminal 50 on the control card is below 10 Volts.

Remove some of the load from terminal 50, as the 10 Volts supply is overloaded. Max. 17 mA/min. 590 Ω.

WARNING/ALARM 2

Live zero fault (LIVE ZERO ERROR):

The current signal on terminal 60 is less than 50% of the value set in parameter 315 *Terminal 60, min. scaling*.

WARNING/ALARM 3

No motor (NO MOTOR):

The motor check function (see parameter 122) indicates that no motor has been connected to the output of the frequency converter.

WARNING/ALARM 4

Phase fault (MAINS PHASE LOSS):

A phase is missing on the supply side or the mains voltage imbalance is too high.

This message can also appear if there is a fault in the input rectifier on the frequency converter.

Check the supply voltage and supply currents to the frequency converter.

WARNING 5

Voltage warning high

(DC LINK VOLTAGE HIGH):

The intermediate circuit voltage (DC) is higher than the overvoltage limit of the control SYSTEM. The frequency converter is still active.

WARNING 6

Voltage warning low (DC LINK VOLTAGE LOW):

The intermediate circuit voltage (DC) is below the undervoltage limit of the control SYSTEM. The frequency converter is still active.

WARNING/ALARM 7

Overvoltage (DC LINK OVERVOLT):

If the intermediate circuit voltage (DC) exceeds the inverter overvoltage limit (see table), the frequency converter will trip after the time set in parameter 410 has passed.

Furthermore, the voltage will be stated in the display. The fault can be eliminated by connecting a brake resistor (if the frequency converter has an integral brake chopper, EB or SB) or by extending the time chosen in parameter 410. In addition, *Brake function/overvoltage control* can be activated in parameter 400.

Alarm/warning limits:

VLT 5000 Series	3 x 200 - 240 V [VDC]	3 x 380 - 500 V [VDC]	3 x 525 - 600 V [VDC]	3 X 525 - 690 v [VDC]
Undervoltage	211	402	557	553
Voltage warning low	222	423	585	585
Voltage warning high (w/ o brake - w/brake)	384/405	801/840 ¹⁾	943/965	1084/1109
Overvoltage	425	855	975	1130

The voltages stated are the intermediate circuit voltage of the frequency converter with a tolerance of $\pm 5\%$. The corresponding mains voltage is the intermediate circuit voltage divided by 1.35

1) VLT 5122 - VLT 5552: 817/828 VDC.

WARNING/ALARM 8
Undervoltage (DC LINK UNDERVOLT):

If the intermediate circuit voltage (DC) drops below the inverter lower voltage limit (see table on previous page), it will be checked whether 24 V power supply is connected.

If no 24 V power supply is connected, the frequency converter will trip after a given time that depends on the unit.

Furthermore, the voltage will be stated in the display. Check whether the supply voltage matches the frequency converter, see technical data.

WARNING/ALARM 9
Inverter overload (INVERTER TIME):

The electronic, thermal inverter protection reports that the frequency converter is about to cut out because of an overload (too high current for too long). The counter for electronic, thermal inverter protection gives a warning at 98% and trips at 100%, while giving an alarm. The frequency converter cannot be reset until the counter is below 90%.

The fault is that the frequency converter is overloaded by more than 100% for too long.

WARNING/ALARM 10
Motor overtemperature (MOTOR TIME):

According to the electronic thermal protection (ETR), the motor is too hot. Parameter 128 allows a choice of whether the frequency converter is to give a warning or an alarm when the counter reaches 100%. The fault is that the motor is overloaded by more than 100% for too long. Check that motor parameters 102-106 have been set correctly.

WARNING/ALARM 11
Motor thermistor (MOTOR THERMISTOR):

The thermistor or the thermistor connection has been disconnected. Parameter 128 allows a choice of whether the frequency converter is to give a warning or an alarm. Check that the thermistor has been cor-

rectly connected between terminal 53 or 54 (analogue voltage input) and terminal 50 (+ 10 Volts supply).

WARNING/ALARM 12
Torque limit (TORQUE LIMIT):

The torque is higher than the value in parameter 221 (in motor operation) or the torque is higher than the value in parameter 222 (in regenerative operation).

WARNING/ALARM 13
Overcurrent (OVERCURRENT):

The inverter peak current limit (approx. 200% of the rated current) has been exceeded. The warning will last approx. 1-2 seconds, following which the frequency converter will trip, while giving an alarm. Turn off the frequency converter and check whether the motor shaft can be turned and whether the motor size matches the frequency converter.

If extended mechanical brake control is selected, trip can be reset externally.

ALARM: 14
Earth fault (Earth fault):

There is a discharge from the output phases to earth, either in the cable between the frequency converter and the motor or in the motor itself.

Turn off the frequency converter and remove the earth fault.

ALARM: 15
Switch mode fault (SWITCH MODE FAULT):

Fault in the switch mode power supply (internal ± 15 V supply).

Contact your Danfoss supplier.

ALARM: 16
Short-circuiting (CURR.SHORT CIRCUIT):

There is short-circuiting on the motor terminals or in the motor itself.

Turn off the frequency converter and remove the short-circuit.

WARNING/ALARM 17
Standard bus timeout (STD BUS TIMEOUT)

There is no communication to the frequency converter. The warning will only be active when parameter 514 has been set to another value than *OFF*.

If parameter 514 has been set to stop and *trip*, it will first give a warning and then ramp down until it trips, while giving an alarm.

Parameter 513 *Bus time interval* could possibly be increased.

WARNING/ALARM 18

HPFB bus timeout (HPFB BUS TIMEOUT)

There is no communication with the frequency converter.

The warning will only be active when parameter 804 has been set to another value than *OFF*.

If parameter 804 has been set to *Stop and trip*, it will first give a warning and then ramp down until it trips, while giving an alarm.

Parameter 803 *Bus time interval* could possibly be increased.

WARNING 19

Fault in the EEPROM on the power card (EE ERROR POWER CARD)

There is a fault on the power card EEPROM. The frequency converter will continue to function, but is likely to fail at the next power-up. Contact your Danfoss supplier.

WARNING 20

Fault in the EEPROM on the control card (EE ERROR CTRL CARD)

There is a fault in the EEPROM on the control card. The frequency converter will continue to function, but is likely to fail at the next power-up. Contact your Danfoss supplier.

ALARM 21

Auto-optimisation OK (AUTO MOTOR ADAPT OK)

The automatic motor tuning is OK and the frequency converter is now ready for operation.

ALARM: 22

Auto-optimisation not OK (AUTO MOT ADAPT FAIL)

A fault has been found during automatic motor adaptation. The text shown in the display indicates a fault message. The figure after the text is the error code, which can be seen in the fault log in parameter 615.

CHECK P.103,105 [0]

See section *Automatic motor adaptation, AMA*.

LOW P.105 [1]

See section *Automatic motor adaptation, AMA*.

ASYMMETRICAL IMPEDANCE [2]

See section *Automatic motor adaptation, AMA*.

MOTOR TOO BIG [3]

See section *Automatic motor adaptation, AMA*.

MOTOR TOO SMALL [4]

See section *Automatic motor adaptation, AMA*.

TIME OUT [5]

See section *Automatic motor adaptation, AMA*.

INTERRUPTED BY USER [6]

See section *Automatic motor adaptation, AMA*.

INTERNAL FAULT [7]

See section *Automatic motor adaptation, AMA*.

LIMIT VALUE FAULT [8]

See section *Automatic motor adaptation, AMA*.

MOTOR ROTATES [9]

See section *Automatic motor adaptation, AMA*.



NB!

AMA can only be carried out if there are no alarms during tuning.

WARNING/ALARM 23

Fault during brake test (BRAKE TEST FAILED):

The brake test is only run after power-up. If *Warning* has been selected in parameter 404, the warning will come when the brake test finds a fault.

If *Trip* has been selected in parameter 404, the frequency converter will trip when the brake test finds a fault.

The brake test may fail for the following reasons:

No brake resistor connected or fault in the connections; defective brake resistor or defective brake transistor. A warning or alarm will mean that the brake function is still active.

WARNING 25

Brake resistor fault (BRAKE RESISTOR FAULT):

The brake resistor is monitored during operation and if it short-circuits, the brake function is disconnected and the warning comes up. The frequency converter will still be able to work, although without the brake function. Turn off the frequency converter and replace the brake resistor.

ALARM/WARNING 26

Brake resistor power 100% (BRAKE PWR WARN 100%):

The power transmitted to the brake resistor is calculated as a percentage, as a mean value over the last 120 sec., on the basis of the resistance value of the brake resistor (parameter 401) and the intermediate circuit voltage. The warning is active when the dissipated braking power is higher than 100%. If *Trip* [2] has been selected in parameter 403, the frequency converter will cut out while giving this alarm.

WARNING 27
**Brake transistor fault
(BRAKE IGBT FAULT):**

The brake transistor is monitored during operation and if it short-circuits, the brake function is disconnected and the warning comes up. The frequency converter will still be able to run, but since the brake transistor has short-circuited, substantial power will be transmitted to the brake resistor, even if it is inactive. Turn off the frequency converter and remove the brake resistor.



Warning: There is a risk of substantial power being transmitted to the brake resistor if the brake transistor has short-circuited.

ALARM: 29
**Heat sink temperature too high
(HEAT SINK OVER TEMP.):**

If the enclosure is IP 00 or IP 20/NEMA 1, the cut-out temperature of the heat-sink is 90°C. If IP 54 is used, the cut-out temperature is 80°C. The tolerance is $\pm 5^\circ\text{C}$. The temperature fault cannot be reset, until the temperature of the heat-sink is below 60°C.

The fault could be the following:

- Ambient temperature too high
- Too long motor cable
- Too high switching frequency.

ALARM: 30
**Motor phase U missing
(MISSING MOT.PHASE U):**

Motor phase U between frequency converter and motor is missing.

Turn off the frequency converter and check motor phase U.

ALARM: 31
**Motor phase V missing
(MISSING MOT.PHASE V):**

Motor phase V between frequency converter and motor is missing.

Turn off the frequency converter and check motor phase V.

ALARM: 32
**Motor phase W missing
(MISSING MOT.PHASE W):**

Motor phase W between frequency converter and motor is missing.

Turn off the frequency converter and check motor phase W.

ALARM: 33
Quick discharge not OK
(QUICK DISCHARGE NOT OK):

Check whether a 24 Volt external DC supply has been connected and that an external brake/discharge resistor has been fitted.

WARNING/ALARM: 34
**Fieldbus communication fault
(FIELD BUS COMMUNICATION FAULT):**

The fieldbus on the communication option card is not working.

WARNING: 35
**Out of frequency range
(OUT OF FREQUENCY RANGE):**

This warning is active if the output frequency has reached its *Output frequency low limit* (parameter 201) or *Output frequency high limit* (parameter 202). If the frequency converter is in *Process control, closed loop* (parameter 100), the warning will be active in the display. If the frequency converter is in another mode than *Process control, closed loop*, bit 008000 *Out of frequency range* in extended status word will be active, while there will be no warning in the display.

WARNING/ALARM: 36
Mains failure (MAINS FAILURE):

This warning/alarm is only active if the supply voltage to the frequency converter is lost and if parameter 407 *Mains fault* has been set to another value than *OFF*.

If parameter 407 has been set to *Contr. ramp-down trip* [2], the frequency converter will first give a warning and then ramp down and trip, while giving an alarm. Check the fuses to the frequency converter.

ALARM: 37
Inverter fault (Inverter fault):

IGBT or the power card is defective. Contact your Danfoss supplier.

Auto-optimisation warnings

Automatic motor adaptation has stopped, since some parameters have probably been set wrongly, or the motor used is too big/small for AMA to be carried out. A choice must thus be made by pressing [CHANGE DATA] and choosing 'Continue' + [OK] or 'Stop' + [OK].

If parameters need to be changed, select 'Stop'; start up AMA all over.

WARNING: 39
CHECK P.104,106

The setting of parameter 102, 104 or 106 is probably wrong. Check the setting and choose 'Continue' or 'Stop'.

WARNING: 40
CHECK P.103,105

The setting of parameter 102, 103 or 105 is probably wrong. Check the setting and choose `Continue' or `Stop'.

WARNING: 41**MOTOR TOO BIG**

The motor used is probably too big for AMA to be carried out. The setting in parameter 102 may not match the motor. Check the motor and choose `Continue' or `Stop'.

WARNING: 42**MOTOR TOO SMALL**

The motor used is probably too small for AMA to be carried out. The setting in parameter 102 may not match the motor. Check the motor and choose `Continue' or `Stop'.

ALARM: 43**Brake fault (BRAKE FAULT)**

A fault has arisen on the brake. The text shown in the display indicates a fault message. The figure after the text is the fault code that can be seen in the fault log, parameter 615.

Brake check failed (BRAKE CHECK FAILED) [0]

The brake check carried out during power-up indicates that the brake has been disconnected. Check whether the brake has been connected correctly and that it has not been disconnected.

Brake resistor short-circuited**(BRAKE RESISTOR FAULT) [1]**

The brake output has short-circuited. Replace the brake resistor.

Brake IGBT short-circuited**(BRAKE IGBT FAULT) [2]**

The brake IGBT has short-circuited. This fault means that the unit is not able to stop the brake and that, consequently, the resistor is constant being energized.

WARNING/ALARM: 44**Encoder loss (ENCODER FAULT)**

The encoder signal is interrupted from terminal 32 or 33. Check the connections.

WARNING/ALARM: 57**Overcurrent (OVERCURRENT)**

As warning/alarm 13, but in this case the warning/alarm occurs together with a quick stop.

ALARM: 60**Safety stop (EXTERNAL FAULT)**

Terminal 27 (parameter 304 Digital Inputs) has been programmed for a safety interlock [3] and is a logic '0'.

VLT® 5000 Series

■ Warning word 1, Extended status word and Alarm word

The **warning word 1**, **extended status word** and the **alarm word** return the different status, warning and alarm messages of the frequency converter as hexadecimal value. If there are more than one warning or alarm, a sum of all warnings or alarms will be shown. Warning word 1, extended status word and alarm word can also be displayed using the serial bus in parameter 540, 541 and 538.

Bit (Hex)	Warning word 1 (parameter 540)
000001	Fault during brake test
000002	EE-prom power card fault
000004	EE-prom control card
000008	HPFP bus timeout
000010	Standard bus timeout
000020	Overcurrent
000040	Torque limit
000080	Motor thermistor
000100	Motor overload
000200	Inverter overload
000400	Undervoltage
000800	Overvoltage
001000	Voltage warning low
002000	Voltage warning high
004000	Phase fault
008000	No motor
010000	Live zero fault (4-20 mA current signal low)
020000	10 Volts low
040000	
080000	Brake resistor power 100%
100000	Brake resistor fault
200000	Brake transistor fault
400000	Out of frequency range
800000	Fieldbus communication fault
1000000	
2000000	Mains failure
4000000	Motor too small
8000000	Motor too big
10000000	Check P. 103 and P. 105
20000000	Check P. 104 and P. 106
40000000	Encoder loss

Bit (Hex)	Extended status word (parameter 541)
000001	Ramping
000002	Automatic motor tuning
000004	Start clockwise/anti-clockwise
000008	Slow down
000010	Catch-up
000020	Feedback high
000040	Feedback low
000080	Output current high
000100	Output current low
000200	Output frequency high
000400	Output frequency low
000800	Brake test ok
001000	Braking max.
002000	Braking
004000	Quick discharge OK
008000	Out of frequency range

Bit (Hex)	Alarm word 1 (parameter 538)
000001	Brake test failed
000002	Trip locked
000004	AMA tuning not OK
000008	AMA tuning OK
000010	Power-up fault
000020	ASIC fault
000040	HPFP bus timeout
000080	Standard bus timeout
000100	Short-circuiting
000200	Switchmode fault
000400	Earth fault
000800	Overcurrent
001000	Torque limit
002000	Motor thermistor
004000	Motor overload
008000	Inverter overload
010000	Undervoltage
020000	Overvoltage
040000	Phase fault
080000	Live zero fault (4 - 20 mA current signal low)
100000	Heat sink temperature too high
200000	Motor phase W missing
400000	Motor phase V missing
800000	Motor phase U missing
1000000	Quick discharge not ok
2000000	Fieldbus communication fault
4000000	Mains failure
8000000	Inverter fault
10000000	Brake power fault
20000000	Encoder loss
40000000	Safety interlock
80000000	Reserved

■ Definitions

VLT:

$I_{VLT,MAX}$

The maximum output current.

$I_{VLT,N}$

The rated output current supplied by the frequency converter.

$U_{VLT,MAX}$

The maximum output voltage.

Output:

I_M

The current transmitted to the motor.

U_M

The voltage transmitted to the motor.

f_M

The frequency transmitted to the motor.

f_{JOG}

The frequency transmitted to the motor when the jog function is activated (via digital terminals or the keypad).

f_{MIN}

The minimum frequency transmitted to the motor.

f_{MAX}

The maximum frequency transmitted to the motor.

Break-away torque:

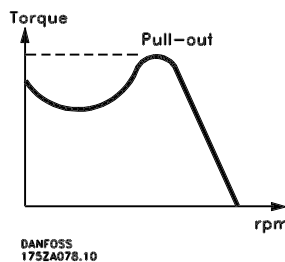

η_{VLT}

The efficiency of the frequency converter is defined as the ratio between the power output and the power input.

Input:

Control command:

By means of LCP and the digital inputs, it is possible to start and stop the connected motor.

Functions are divided into two groups, with the following priorities:

Group 1	Reset, Coasting stop, Reset and Coasting stop, Quick-stop, DC braking, Stop and the "Stop" key.
Group 2	Start, Pulse start, Reversing, Start reversing, Jog and Freeze output

Group 1 functions are called Start-disable commands. The difference between group 1 and group 2 is that in group 1 all stop signals must be cancelled for the motor to start. The motor can then be started by means of a single start signal in group 2.

A stop command given as a group 1 command results in the display indication STOP.

A missing stop command given as a group 2 command results in the display indication STAND BY.

Start-disable command:

A stop command that belongs to group 1 of the control commands - see this group.

Stop command:

See Control commands.

Motor:

$I_{M,N}$

The rated motor current (nameplate data).

$f_{M,N}$

The rated motor frequency (nameplate data).

$U_{M,N}$

The rated motor voltage (nameplate data).

$P_{M,N}$

The rated power delivered by the motor (nameplate data).

$n_{M,N}$

The rated motor speed (nameplate data).

$T_{M,N}$

The rated torque (motor).

References:

preset ref.

A firmly defined reference which can be set from -100% to +100% of the reference range. There are four preset references, which can be selected via the digital terminals.

analogue ref.

A signal transmitted to input 53, 54 or 60. Can be voltage or current.

pulse ref.

A signal transmitted to the digital inputs (terminal 17 or 29).

binary ref.

A signal transmitted to the serial communication port.

Ref_{MIN}

The smallest value which the reference signal may have. Set in parameter 204.

Ref_{MAX}

The maximum value which the reference signal may have. Set in parameter 205.

Miscellaneous:

ELCB:

Earth Leakage Circuit Breaker.

lsb:

Least significant bit.

Used in serial communication.

msb

Most significant bit.

Used in serial communication.

PID:

The PID regulator maintains the desired speed (pressure, temperature, etc.) by adjusting the output frequency to match the varying load.

Trip:

A state which occurs in different situations, e.g. if the frequency converter is subjected to an overtemperature. A trip can be cancelled by pressing reset or, in some cases, automatically.

Trip locked:

A state which occurs in different situations, e.g. if the frequency converter is subject to an overtemperature. A locked trip can be cancelled by cutting off mains and restarting the frequency converter.

Initialising:

If initialising is carried out, the frequency converter returns to the factory setting.

Setup:

There are four Setups, in which it is possible to save parameter settings. It is possible to change between the four parameter Setups and to edit one Setup, while another Setup is active.

LCP:

The control panel, which makes up a complete interface for control and programming of VLT 5000 Series. The control panel is detachable and may, as an alternative, be installed up to 3 metres away from the frequency converter, i.e. in a front panel, by means of the installation kit option.

VVC^{plus}

If compared with standard voltage/frequency ratio control, VVC^{plus} improves the dynamics and the stability, both when the speed reference is changed and in relation to the load torque.

Slip compensation:

Normally, the motor speed will be affected by the load, but this load dependence is unwanted. The frequency converter compensates for the slip by giving the frequency a supplement that follows the measured effective current.

Thermistor:

A temperature-dependent resistor placed where the temperature is to be monitored (frequency converter or motor).

Analogue inputs:

The analogue inputs can be used for controlling various functions of the frequency converter.

There are two types of analogue inputs:

Current input, 0-20 mA

Voltage input, 0-10 V DC.

Analogue outputs:

There are two analogue outputs, which are able to supply a signal of 0-20 mA, 4-20 mA or a digital signal.

Digital inputs:

The digital inputs can be used for controlling various functions of the frequency converter.

Digital outputs:

There are four digital outputs, two of which activate a relay switch. The outputs are able to supply a 24 V DC (max. 40 mA) signal.

Brake resistor:

The brake resistor is a module capable of absorbing the brake power that is generated in regenerative braking. This regenerative braking power increases the intermediate circuit voltage and a brake chopper ensures that the power is transmitted to the brake resistor.

Pulse encoder:

An external, digital pulse transmitter used for feeding back information on motor speed. The encoder is used in applications where great accuracy in speed control is required.

AWG:

Means American Wire Gauge, i.e. the American measuring unit for cable cross-section.

Manual initialisation:

Press the [CHANGE DATA] + [MENU] + [OK] keys at the same time to carry out manual initialisation.

60° AVM

Switching pattern called 60° A synchronous Vector Modulation.

SFAVM

Switching pattern called Stator Flux oriented A synchronous Vector Modulation.

Automatic motor adjustment, AMA:

Automatic motor adjustment algorithm, which determines the electrical parameters for the connected motor, at standstill.

On-line/off-line parameters:

On-line parameters are activated immediately after the data value is changed. Off-line parameters are not activated until OK has been entered on the control unit.

VT characteristics:

Variable torque characteristics, used for pumps and fans.

CT characteristics:

Constant torque characteristics, used for all applications, such as conveyor belts and cranes. CT characteristics are not used for pumps and fans.

MCM:

Stands for Mille Circular Mil, an American measuring unit for cable cross-section. 1 MCM • 0.5067 mm².

■ Factory Settings

PNU #	Parameter description	Factory setting	Range	Changes during operation	4-Setup	Conversion index	Data type
001	Language	English		Yes	No	0	5
002	Local/remote control	Remote control		Yes	Yes	0	5
003	Local reference	000.000		Yes	Yes	-3	4
004	Active setup	Setup 1		Yes	No	0	5
005	Programming setup	Active setup		Yes	No	0	5
006	Copying of setups	No copying		No	No	0	5
007	LCP copy	No copying		No	No	0	5
008	Display scaling of motor frequency	1	0.01 - 500.00	Yes	Yes	-2	6
009	Display line 2	Frequency [Hz]		Yes	Yes	0	5
010	Display line 1.1	Reference [%]		Yes	Yes	0	5
011	Display line 1.2	Motor current [A]		Yes	Yes	0	5
012	Display line 1.3	Power [kW]		Yes	Yes	0	5
013	Local control/configura	LCP digital control/as par. 100		Yes	Yes	0	5
014	Local stop	Possible		Yes	Yes	0	5
015	Local jog	Not possible		Yes	Yes	0	5
016	Local reversing	Not possible		Yes	Yes	0	5
017	Local reset of trip	Possible		Yes	Yes	0	5
018	Lock for data change	Not locked		Yes	Yes	0	5
019	Operating state at power-up, local control	Forced stop, use saved ref.		Yes	Yes	0	5
027	Warning readout	Warning in line 1/2		Yes	No	0	5

Changes during operation:

"Yes" means that the parameter can be changed, while the frequency converter is in operation. "No" means that the frequency converter must be stopped before a change can be made.

4-Setup:

"Yes" means that the parameter can be programmed individually in each of the four setups, i.e. the same parameter can have four different data values. "No" means that the data value will be the same in all four setups.

Conversion index:

This number refers to a conversion figure to be used when writing or reading by means of a frequency converter.

Conversion index	Conversion factor
74	0.1
2	100
1	10
0	1
-1	0.1
-2	0.01
-3	0.001
-4	0.0001

Data type:

Data type shows the type and length of the telegram.

Data type	Description
3	Integer 16
4	Integer 32
5	Unsigned 8
6	Unsigned 16
7	Unsigned 32
9	Text string

VLT® 5000 Series

PNU #	Parameter description	Factory setting	Range	Change			Data type
				s during operation	4-Setup	Conversion index	
100	Configuration	Speed control, open loop		No	Yes	0	5
101	Torque characteristics	High - constant torque		Yes	Yes	0	5
102	Motor power	Depends on the unit	0.18-600 kW	No	Yes	1	6
103	Motor voltage	Depends on the unit	200 - 600 V	No	Yes	0	6
104	Motor frequency	50 Hz / 60 Hz		No	Yes	0	6
105	Motor current	Depends on the unit	0.01- $I_{VLT,MAX}$	No	Yes	-2	7
106	Rated motor speed	Depends on the unit	100-60000 rpm	No	Yes	0	6
107	Automatic motor adaptation, AMA	Adaptation off		No	No	0	5
108	Stator resistor	Depends on the unit		No	Yes	-4	7
109	Stator reactance	Depends on the unit		No	Yes	-2	7
110	Motor magnetizing, 0 rpm	100 %	0 - 300 %	Yes	Yes	0	6
111	Min. frequency normal magnetizing	1.0 Hz	0.1 - 10.0 Hz	Yes	Yes	-1	6
112							
113	Load compensation at low speed	100 %	0 - 300 %	Yes	Yes	0	6
114	Load compensation at high speed	100 %	0 - 300 %	Yes	Yes	0	6
115	Slip compensation	100 %	-500 - 500 %	Yes	Yes	0	3
116	Slip compensation time constant	0.50 s	0.05 - 1.00 s	Yes	Yes	-2	6
117	Resonance dampening	100 %	0 - 500 %	Yes	Yes	0	6
118	Resonance dampening time constant	5 ms	5 - 50 ms	Yes	Yes	-3	6
119	High starting torque	0.0 sec.	0.0 - 0.5 s	Yes	Yes	-1	5
120	Start delay	0.0 sec.	0.0 - 10.0 s	Yes	Yes	-1	5
121	Start function	Coasting in start delay time		Yes	Yes	0	5
122	Function at stop	Coasting		Yes	Yes	0	5
123	Min. frequency for activating function at stop	0.0 Hz	0.0 - 10.0 Hz	Yes	Yes	-1	5
124	DC holding current	50 %	0 - 100 %	Yes	Yes	0	6
125	DC braking current	50 %	0 - 100 %	Yes	Yes	0	6
126	DC braking time	10.0 sec.	0.0 - 60.0 sec.	Yes	Yes	-1	6
127	DC brake cut-in frequency	Off	0.0-par. 202	Yes	Yes	-1	6
128	Motor thermal protection	No protection		Yes	Yes	0	5
129	External motor fan	No		Yes	Yes	0	5
130	Start frequency	0.0 Hz	0.0-10.0 Hz	Yes	Yes	-1	5
131	Initial voltage	0.0 V	0.0-par. 103	Yes	Yes	-1	6
145	Minimum DC brake time	0 sec.	0 - 10 sec.	Yes	Yes	-1	6

VLT® 5000 Series

PNU #	Parameter description	Factory setting	Range	Changes during operation	4-Setup	Conversion index	Data type
200	Output frequency range/direction	Only clockwise, 0-132 Hz		No	Yes	0	5
201	Output frequency low limit	0.0 Hz	0.0 - f_{MAX}	Yes	Yes	-1	6
202	Output frequency high limit	66 / 132 Hz	f_{MIN} - par. 200	Yes	Yes	-1	6
203	Reference/feedback area	Min - max		Yes	Yes	0	5
204	Minimum reference	0.000	-100,000.000-Ref _{MAX}	Yes	Yes	-3	4
205	Maximum reference	50.000	Ref _{MIN} -100,000.000	Yes	Yes	-3	4
206	Ramp type	Linear		Yes	Yes	0	5
207	Ramp-up time 1	Depends on unit	0.05 - 3600	Yes	Yes	-2	7
208	Ramp-down time 1	Depends on unit	0.05 - 3600	Yes	Yes	-2	7
209	Ramp-up time 2	Depends on unit	0.05 - 3600	Yes	Yes	-2	7
210	Ramp-down time 2	Depends on unit	0.05 - 3600	Yes	Yes	-2	7
211	Jog ramp time	Depends on unit	0.05 - 3600	Yes	Yes	-2	7
212	Quick stop ramp-down time	Depends on unit	0.05 - 3600	Yes	Yes	-2	7
213	Jog frequency	10.0 Hz	0.0 - par. 202	Yes	Yes	-1	6
214	Reference function	Sum		Yes	Yes	0	5
215	Preset reference 1	0.00 %	- 100.00 - 100.00 %	Yes	Yes	-2	3
216	Preset reference 2	0.00 %	- 100.00 - 100.00 %	Yes	Yes	-2	3
217	Preset reference 3	0.00 %	- 100.00 - 100.00 %	Yes	Yes	-2	3
218	Preset reference 4	0.00 %	- 100.00 - 100.00 %	Yes	Yes	-2	3
219	Catch up/slow down value	0.00 %	0.00 - 100 %	Yes	Yes	-2	6
220							
221	Torque limit for motor mode	160 %	0.0 % - xxx %	Yes	Yes	-1	6
222	Torque limit for regenerative operation	160 %	0.0 % - xxx %	Yes	Yes	-1	6
223	Warning: Low current	0.0 A	0.0 - par. 224	Yes	Yes	-1	6
224	Warning: High current	I _{VLT,MAX}	Par. 223 - I _{VLT,MAX}	Yes	Yes	-1	6
225	Warning: Low frequency	0.0 Hz	0.0 - par. 226	Yes	Yes	-1	6
226	Warning: High frequency	132.0 Hz	Par. 225 - par. 202	Yes	Yes	-1	6
227	Warning: Low feedback	-4000.000	-100,000.000 - par. 228	Yes		-3	4
228	Warning: High feedback	4000.000	Par. 227 - 100,000.000	Yes		-3	4
229	Frequency bypass, bandwidth	OFF	0 - 100 %	Yes	Yes	0	6
230	Frequency bypass 1	0.0 Hz	0.0 - par. 200	Yes	Yes	-1	6
231	Frequency bypass 2	0.0 Hz	0.0 - par. 200	Yes	Yes	-1	6
232	Frequency bypass 3	0.0 Hz	0.0 - par. 200	Yes	Yes	-1	6
233	Frequency bypass 4	0.0 Hz	0.0 - par. 200	Yes	Yes	-1	6
234	Motor phase monitor	Enable		Yes	Yes	0	5

VLT® 5000 Series

PN U #	Parameter description	Factory setting	Range	Chang es during operation	4-Setup	Conversion index	Data type
300	Terminal 16, input	Reset		Yes	Yes	0	5
301	Terminal 17, input	Freeze reference		Yes	Yes	0	5
302	Terminal 18 Start, input	Start		Yes	Yes	0	5
303	Terminal 19, input	Reversing		Yes	Yes	0	5
304	Terminal 27, input	Coasting stop, inverse		Yes	Yes	0	5
305	Terminal 29, input	Jog		Yes	Yes	0	5
306	Terminal 32, input	Choice of setup, msb/speed up		Yes	Yes	0	5
307	Terminal 33, input	Choice of setup, lsb/speed down		Yes	Yes	0	5
308	Terminal 53, analogue input voltage	Reference		Yes	Yes	0	5
309	Terminal 53, min. scaling	0.0 V	0.0 - 10.0 V	Yes	Yes	-1	5
310	Terminal 53, max. scaling	10.0 V	0.0 - 10.0 V	Yes	Yes	-1	5
311	Terminal 54, analogue input voltage	No operation		Yes	Yes	0	5
312	Terminal 54, min. scaling	0.0 V	0.0 - 10.0 V	Yes	Yes	-1	5
313	Terminal 54, max. scaling	10.0 V	0.0 - 10.0 V	Yes	Yes	-1	5
314	Terminal 60, analogue input current	Reference		Yes	Yes	0	5
315	Terminal 60, min. scaling	0.0 mA	0.0 - 20.0 mA	Yes	Yes	-4	5
316	Terminal 60, max. scaling	20.0 mA	0.0 - 20.0 mA	Yes	Yes	-4	5
317	Time out	10 sec.	1 - 99 sec.	Yes	Yes	0	5
318	Function after time out	Off		Yes	Yes	0	5
319	Terminal 42, output	0 - I _{MAX} P 0-20 mA		Yes	Yes	0	5
320	Terminal 42, output, pulse scaling	5000 Hz	1 - 32000 Hz	Yes	Yes	0	6
321	Terminal 45, output	0 - f _{MAX} P 0-20 mA		Yes	Yes	0	5
322	Terminal 45, output, pulse scaling	5000 Hz	1 - 32000 Hz	Yes	Yes	0	6
323	Relay 01, output	Ready - no thermal warning		Yes	Yes	0	5
324	Relay 01, ON delay	0.00 sec.	0.00 - 600 sec.	Yes	Yes	-2	6
325	Relay 01, OFF delay	0.00 sec.	0.00 - 600 sec.	Yes	Yes	-2	6
326	Relay 04, output	Ready - remote control		Yes	Yes	0	5
327	Pulse reference, max. frequency	5000 Hz		Yes	Yes	0	6
328	Pulse feedback, max. frequency	25000 Hz		Yes	Yes	0	6
329	Encoder feedback pulse/rev.	1024 pulses/rev.	1 - 4096 pulses/ rev.	Yes	Yes	0	6
330	Freeze reference/output function	No operation		Yes	No	0	5
345	Encoder loss timeout	1 sec.	0 - 60 sec	Yes	Yes	-1	6
346	Encoder loss function	OFF		Yes	Yes	0	5
357	Terminal 42, Output minimum scaling	0 %	000 - 100%	Yes	Yes	0	6
358	Terminal 42, Output maximum scaling	100%	000 - 500%	Yes	Yes	0	6
359	Terminal 45, Output minimum scaling	0 %	000 - 100%	Yes	Yes	0	6
360	Terminal 45, Output maximum scaling	100%	000 - 500%	Yes	Yes	0	6
361	Encoder loss threshold	300%	000 - 600 %	Yes	Yes	0	6

VLT® 5000 Series

PN U #	Parameter description	Factory setting	Range	Change s during operation	4-Setup	Conver- sion index	Data type
400	Brake function/overvoltage control	Off		Yes	No	0	5
401	Brake resistor, ohm	Depends on the unit		Yes	No	-1	6
402	Brake power limit, kW	Depends on the unit		Yes	No	2	6
403	Power monitoring	On		Yes	No	0	5
404	Brake check	Off		Yes	No	0	5
405	Reset function	Manual reset		Yes	Yes	0	5
406	Automatic restart time	5 sec.	0 - 10 sec.	Yes	Yes	0	5
407	Mains Failure	No function		Yes	Yes	0	5
408	Quick discharge	Not possible		Yes	Yes	0	5
409	Trip delay torque	Off	0 - 60 sec.	Yes	Yes	0	5
410	Trip delay-inverter	Depends on type of unit	0 - 35 sec.	Yes	Yes	0	5
411	Switching frequency	Depends on type of unit	1.5 - 14 kHz	Yes	Yes	2	6
412	Output frequency dependent switching frequency	Not possible		Yes	Yes	0	5
413	Overmodulation function	On		Yes	Yes	-1	5
414	Minimum feedback	0.000	-100,000.000 - FB _{HIGH}	Yes	Yes	-3	4
415	Maximum feedback	1500.000	FB _{LOW} - 100,000.000	Yes	Yes	-3	4
416	Process unit	%		Yes	Yes	0	5
417	Speed PID proportional gain	0.015	0.000 - 0.150	Yes	Yes	-3	6
418	Speed PID integration time	8 ms	2.00 - 999.99 ms	Yes	Yes	-4	7
419	Speed PID differentiation time	30 ms	0.00 - 200.00 ms	Yes	Yes	-4	6
420	Speed PID diff. gain ratio	5.0	5.0 - 50.0	Yes	Yes	-1	6
421	Speed PID low-pass filter	10 ms	5 - 200 ms	Yes	Yes	-4	6
422	U 0 voltage at 0 Hz	20.0 V	0.0 - parame- ter 103	Yes	Yes	-1	6
423	U 1 voltage	parameter 103	0.0 - U _{VLT, MAX}	Yes	Yes	-1	6
424	F 1 frequency	parameter 104	0.0 - parame- ter 426	Yes	Yes	-1	6
425	U 2 voltage	parameter 103	0.0 - U _{VLT, MAX}	Yes	Yes	-1	6
426	F 2 frequency	parameter 104	par.424-par. 428	Yes	Yes	-1	6
427	U 3 voltage	parameter 103	0.0 - U _{VLT, MAX}	Yes	Yes	-1	6
428	F 3 frequency	parameter 104	par.426 -par. 430	Yes	Yes	-1	6
429	U 4 voltage	parameter 103	0.0 - U _{VLT, MAX}	Yes	Yes	-1	6

VLT® 5000 Series

PN U #	Parameter description	Factory setting	Range	Change s during operation	4-Setup	Conver- sion index	Data type
430	F 4 frequency	parameter 104	par.426-par.432	Yes	Yes	-1	6
431	U 5 voltage	parameter 103	.0 - U _{VLT, MAX}	Yes	Yes	-1	6
432	F 5 frequency	parameter 104	par.426 - 1000 Hz	Yes	Yes	-1	6
433	Torque proportional gain	100%	0 (Off) - 500%	Yes	Yes	0	6
434	Torque integral time	0.02 sec.	0.002 - 2.000 sec.	Yes	Yes	-3	7
437	Process PID Normal/inverse control	Normal		Yes	Yes	0	5
438	Process PID anti windup	On		Yes	Yes	0	5
439	Process PID start frequency	parameter 201	f _{min} - f _{max}	Yes	Yes	-1	6
440	Process PID proportional gain	0.01	0.00 - 10.00	Yes	Yes	-2	6
441	Process PID integral time	9999.99 sec. (OFF)	0.01 - 9999.99 sec.	Yes	Yes	-2	7
442	Process PID differentiation time	0.00 sec. (OFF)	0.00 - 10.00 sec.	Yes	Yes	-2	6
443	Process PID diff. gain limit	5.0	5.0 - 50.0	Yes	Yes	-1	6
444	Process PID lowpass filter time	0.01	0.01 - 10.00	Yes	Yes	-2	6
445	Flying start	Disable		Yes	Yes	0	5
446	Switching pattern	SFAVM		Yes	Yes	0	5
447	Torque compensation	100%	-100 - +100%	Yes	Yes	0	3
448	Gear ratio	1	0.001 - 100.000	No	Yes	-2	4
449	Friction loss	0%	0 - 50%	No	Yes	-2	6
450	Mains voltage at mains fault	Depends on unit	Depends on unit	Yes	Yes	0	6
453	Speed closed loop gear ratio	1	0.01-100	No	Yes	0	4
454	Dead time compensation	On		No	No	0	5
455	Frequency range monitor	Enable				0	5
457	Phase loss function	Trip		Yes	Yes	0	5
483	Dynamic DC Link compensation	On		No	No	0	5

VLT® 5000 Series

PNU #	Parameter description	Factory setting	Range	Changes during operation	4-Setup	Conversion index	Data type
500	Address	1	0 - 126	Yes	No	0	6
501	Baudrate	9600 Baud		Yes	No	0	5
502	Coasting	Logic or		Yes	Yes	0	5
503	Quick-stop	Logic or		Yes	Yes	0	5
504	DC-brake	Logic or		Yes	Yes	0	5
505	Start	Logic or		Yes	Yes	0	5
506	Reversing	Logic or		Yes	Yes	0	5
507	Selection of setup	Logic or		Yes	Yes	0	5
508	Selection of speed	Logic or		Yes	Yes	0	5
509	Bus jog 1	10.0 Hz	0.0 - parameter 202	Yes	Yes	-1	6
510	Bus jog 2	10.0 Hz	0.0 - parameter 202	Yes	Yes	-1	6
511							
512	Telegram profile	FC Drive		No	Yes	0	5
513	Bus time interval	1 sec.	1 - 99 s	Yes	Yes	0	5
514	Bus time interval function	Off		Yes	Yes	0	5
515	Data read-out: Reference %			No	No	-1	3
516	Data read-out: Reference unit			No	No	-3	4
517	Data read-out: Feedback			No	No	-3	4
518	Data read-out: Frequency			No	No	-1	6
519	Data read-out: Frequency x Scaling			No	No	-2	7
520	Data read-out: Current			No	No	-2	7
521	Data read-out: Torque			No	No	-1	3
522	Data read-out: Power, kW			No	No	1	7
523	Data read-out: Power, HP			No	No	-2	7
524	Data read-out: Motor voltage			No	No	-1	6
525	Data read-out: DC link voltage			No	No	0	6
526	Data read-out: Motor temp.			No	No	0	5
527	Data read-out: VLT temp.			No	No	0	5
528	Data read-out: Digital input			No	No	0	5
529	Data read-out: Terminal 53, analogue input			No	No	-2	3
530	Data read-out: Terminal 54, analogue input			No	No	-2	3
531	Data read-out: Terminal 60, analogue input			No	No	-5	3
532	Data read-out: Pulse reference			No	No	-1	7
533	Data read-out: External reference %			No	No	-1	3
534	Data read-out: Status word, binary			No	No	0	6
535	Data read-out: Brake power/2 min.			No	No	2	6
536	Data read-out: Brake power/sec.			No	No	2	6
537	Data read-out: Heat sink temperature			No	No	0	5
538	Data read-out: Alarm word, binary			No	No	0	7
539	Data read-out: VLT Control word, binary			No	No	0	6
540	Data read-out: Warning word, 1			No	No	0	7
541	Data read-out: Extended Status word			No	No	0	7
553	Display text 1			No	No	0	9
554	Display text 2			No	No	0	9
557	Data read-out: Motor RPM			No	No	0	4
558	Data read-out: Motor RPM x scaling			No	No	-2	4
580	Defined parameter			No	No	0	6
581	Defined parameter			No	No	0	6
582	Defined parameter			No	No	0	6

VLT® 5000 Series

PNU #	Parameter description	Factory setting	Range	Change s during operation	4-Setup	Conver- sion index	Data type
600	Operating data: Operating hours			No	No	74	7
601	Operating data: Hours run			No	No	74	7
602	Operating data: kWh counter			No	No	1	7
603	Operating data: Number of power-up's			No	No	0	6
604	Operating data: Number of overtemperatures			No	No	0	6
605	Operating data: Number of overvoltages			No	No	0	6
606	Data log: Digital input			No	No	0	5
607	Data log: Bus commands			No	No	0	6
608	Data log: Bus Status word			No	No	0	6
609	Data log: Reference			No	No	-1	3
610	Data log: Feedback			No	No	-3	4
611	Data log: Motor frequency			No	No	-1	3
612	Data log: Motor voltage			No	No	-1	6
613	Data log: Motor current			No	No	-2	3
614	Data log: DC link voltage			No	No	0	6
615	Fault log: Error code			No	No	0	5
616	Fault log: Time			No	No	-1	7
617	Fault log: Value			No	No	0	3
618	Reset of kWh counter	No reset		Yes	No	0	5
619	Reset of hours-run counter	No reset		Yes	No	0	5
620	Operating mode Normal function	Normal function		No	No	0	5
621	Nameplate: VLT type			No	No	0	9
622	Nameplate: Power section			No	No	0	9
623	Nameplate: VLT ordering number			No	No	0	9
624	Nameplate: Software version no.			No	No	0	9
625	Nameplate: LCP identification no.			No	No	0	9
626	Nameplate: Database identification no.			No	No	-2	9
627	Nameplate: Power section identification no.			No	No	0	9
628	Nameplate: Application option type			No	No	0	9
629	Nameplate: Application option ordering no.			No	No	0	9
630	Nameplate: Communication option type			No	No	0	9
631	Nameplate: Communication option ordering no.			No	No	0	9

VLT® 5000 Series

PNU #	Parameter description	Factory setting	Range	Change s during operation	4-Setup	Conversion index	Data type
700	Relay 6, function	Ready signal		Yes	Yes	0	5
701	Relay 6, ON delay	0 sec.	0.00-600 sec.	Yes	Yes	-2	6
702	Relay 6, OFF delay	0 sec.	0.00-600 sec.	Yes	Yes	-2	6
703	Relay 7, function	Motor running		Yes	Yes	0	5
704	Relay 7, ON delay	0 sec.	0.00-600 sec.	Yes	Yes	-2	6
705	Relay 7, OFF delay	0 sec.	0.00-600 sec.	Yes	Yes	-2	6
706	Relay 8, function	Mains ON		Yes	Yes	0	5
707	Relay 8, ON delay	0 sec.	0.00-600 sec.	Yes	Yes	-2	6
708	Relay 8, OFF delay	0 sec.	0.00-600 sec.	Yes	Yes	-2	6
709	Relay 9, function	Fault		Yes	Yes	0	5
710	Relay 9, ON delay	0 sec.	0.00-600 sec.	Yes	Yes	-2	6
711	Relay 9, OFF delay	0 sec.	0.00-600 sec.	Yes	Yes	-2	6

■ Index
A

acceleration time	116
Accuracy of display readout (parameters 009-012)	13
Address	152
Alarm messages	171
Alarm word	176
Alarms	170
AMA	85
AMA	106
analog inputs	126
Analogue input current	128
Analogue input voltage	127
Application configuration	74
Application option	163
Automatic motor adaptation	106
Automatic Motor Adaptation, AMA	85
Automatic reset	140

B

Baudrate	152
Brake function	78
Brake resistor	13
Braking time	78
Bus time interval	153

C

Cable clamp	61
cable clamps	57
Cable lengths	13
Catch spinning motor,	149
Catch up	118
Catch up	118
Catch-up/Slow-down	124
Change of group of numeric data values	69
Changing a text value	69
Changing data	69
Coasting	152
Coasting stop	123
Communication option	163
Configuration	103
Connection of motor	42
control cables	57
Control card test	161
Control card, 24 V DC supply	12
Control card, analogue inputs	11
Control card, digital inputs	11
Control card, digital/pulse and analogue outputs	12
Control card, pulse/encoder input	12
Control card, RS 485 serial communication	12
Control characteristics	13
Control key functions	66
Control panel - control keys	66
Control panel - display	65
Control panel - display read-outs	66
Control panel - LEDs	65
Control panel (LCP)	65
Cooling	39
Cooling	40
Current reference with speed feedback	73

D

Data change	101
-------------	-----

Data change lock	125
Data value, step-by-step	70
data-logs	159
DC brake	111
DC braking	123
DC holding	111
DC-brake	152
deceleration time	116
Definitions	178
Digital speed up/down	72
DIP Switches 1-4	56
Direction	114
direction of motor rotation	42
Direction of motor rotation	42
Display	99
Display - Status messages	167
Display mode	67
Display mode - selection of read-outstate	67

E

earthing	61
Electrical installation	41
Electrical installation	55
Electrical installation - 24 Volt external DC supply	45
Electrical installation - brake cable	43
Electrical installation - brake resistor temperature switch	43
Electrical installation - bus connection	56
Electrical installation - control cables	53
Electrical installation - earthing of control cables	61
Electrical installation - EMC precautions	57
Electrical installation - external fan supply	45
Electrical installation - mains supply	41
Electrical installation - motor cables	42
Electrical installation - relay outputs	45
Electrical installation, power cables	46
Encoder connection	73
Encoder feedback	125
Encoder feedback	135
Encoder loss	135
Equalising cable,	61
ETR	112
Extended mechanical brake control	87
External 24 V DC supply	13
External 24 V DC supply	45
External motor fan	112
Externals	14

F

Factory settings	181
Fault log	160
Fault log: Time	160
Fault log: Value	160
Feedback	142
Feedback	142
Feedback signal	115
Feedback-signal.	126
Flying start	149
Flying start	93
Freeze output	124
Freeze reference	124
Freeze reference/output	135
Frequency bypass	121
Fuses	33

G

Galvanically isolated	56
General technical data	10
General warning	4

H

Harmonic filter	151
High current	120
High feedback	120
High frequency	120
High voltage test	41

I

Indexed parameters	70
Infinitely variable change of numeric data value	69
Initialisation to factory setting	70
Installation of mechanical brake	5
Internal current regulator	94
Introduction	3
IT mains	62

J

Jog	123
-----	-----

K

KWh counter	160
kWh counter,	159

L

Language	96
Language 001	96
Latched start	123
LCP copy	97
LCP identification	163
Literature	9
Loadsharing	43
Local and remote control	77
Local jog	101
Local reversing	101
Local stop	100
Low current	119
Low feedback	120
Low frequency	120

M

Mains failure	124
Mains failure	140
Mains failure/quick discharge with mains failure inverse	92
Mains fault	150
Mains supply	16
Mains supply (L1, L2, L3):	10
Manual reset	140
Mechanical brake control	87
Mechanical dimensions	35
Mechanical installation	38
Menu mode	68
Menu structure	71
Motor cables	57
motor phases.	121
Motor protection	43
Motor thermal protection	43

Motor thermal protection	112
--------------------------	-----

N

Normal/high overload torque control, open loop	94
--	----

O

Operating hours,	159
Output data	10
Output frequency	114
Outputs	130
Overvoltage control	138

P

Parallel coupling of motors	42
Parameter selection	68
Parameter selection	69
Parameter Setup	68
Parameters - Relay option	164
PID for process control	89
PID for speed control	90
PLC	61
Potentiometer reference	72
Power up	101
Pre-heat	111
Preset reference,	123
Preset references	118
Process control, closed loop	103
Process PID	147
Programming of Torque limit and stop	94
Programming Setup	97
proportional gain	144
Protocol	157
Pulse feedback	125
Pulse reference	134
Pulse reference	125
Pulse start/stop	72

Q

Quick discharge	91
Quick Setup	68
Quick-stop	123
Quick-stop	152

R

Ramp type	116
Ramp-down time	116
Ramp-up time	116
Read out via the serial communication	155
Reference	96
Reference function	117
Reference signal	115
Reference.	126
Reference/feedback unit	143
References - multi-references	81
References - single references	79
Relative reference	127
Relay	133
Relay	134
Relay outputs:	12
Relay outputs:	12
Reset	140
Reset	123
Resistor brake	138
Reversing	123

Reversing	153
RFI switch	62
RS 485	56

VLT type,	163
Voltage level	150

S

Safety earthing	41
Safety interlock	125
Safety regulations	4
Selection of Setup	152
Selection of Setup,	124
Selection of speed	152
serial communication	61
Setting of parameters	74
Setup	97
Setup change	72
SFAVM	149
single references.	127
single references.	128
Slow down	118
Software version	163
Speed control, closed loop	103
Speed control, open loop	103
Speed down	124
Speed PID	144
Speed up	124
Start	123
Start	152
Start anti-clockwise only	123
Start clockwise only	123
stator resistance	107
status word	176
Stop	123
Switching frequency	141
Switching pattern	149

W

Warning against unintended start	5
Warning word	176
Warnings	170
Warnings	171
Warnings and alarms	170

T

Telegram profile	153
Thermistor	112
Thermistor.	126
Tightening-up torques and screw sizes	44
Time out	128
Torque characteristics	10
Torque characteristics	103
Torque control, open loop	103
Torque control, speed feedback	103
Torque limit	118
Torque limit	119
Torque limit.	126
Trip locked	170
Trouble-shooting	166
Two wire start/stop	72
Two-wire transmitter	73

U

U/f characteristic	145
Unintended start	5
Unit data	163
Use of emc-correct cables	60

V

VLT 5000 Series protection:	15
VLT 5000 Series protection:	15
VLT ordering number,	163
Vlt output data (u, v, w):	10