

contents:

- 1pcs filter cover (RAL 7001)
- 1pcs terminal cover (RAL 7001)
- 1pcs screen connection plate (zink plated steel)
- 2pcs cable clamp 130N3206
- 4pcs screws M4x20
- 2pcs earth screws M6x16
(with lockwasher and washer)

filter cover

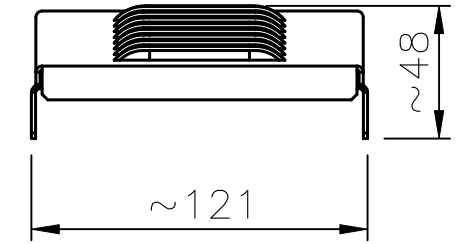
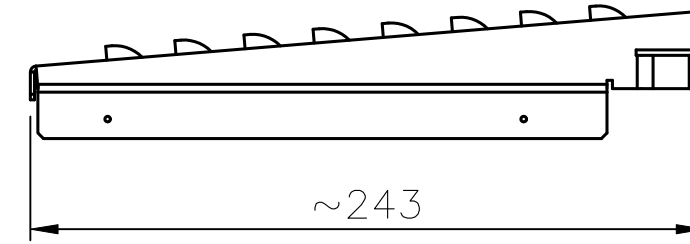

terminal cover

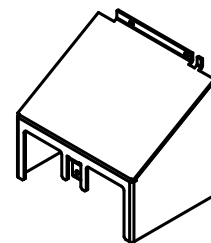
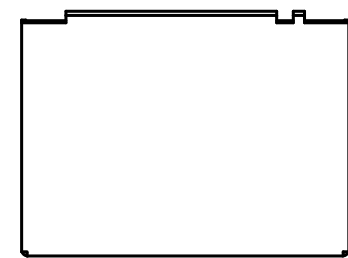
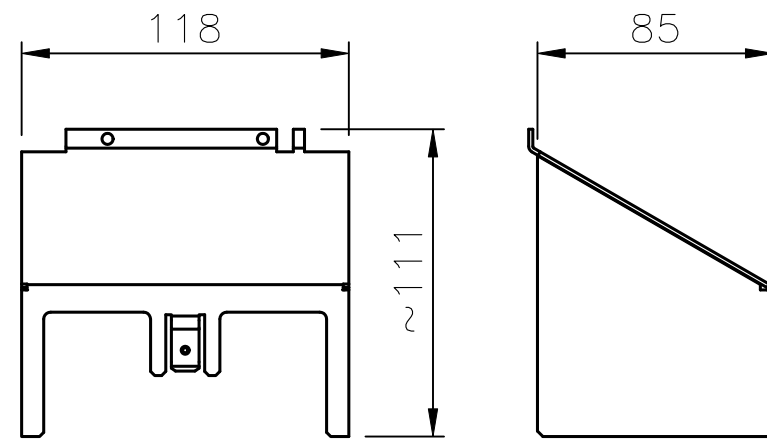

screen connection plate

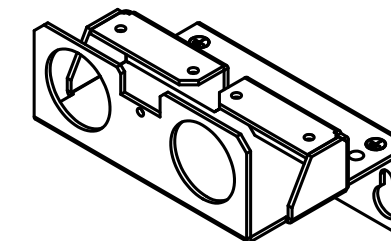
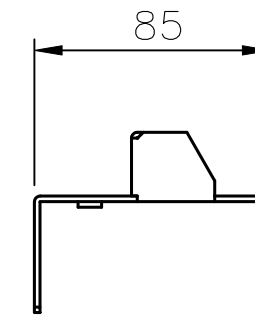
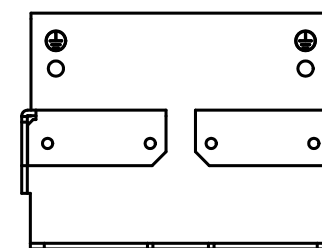
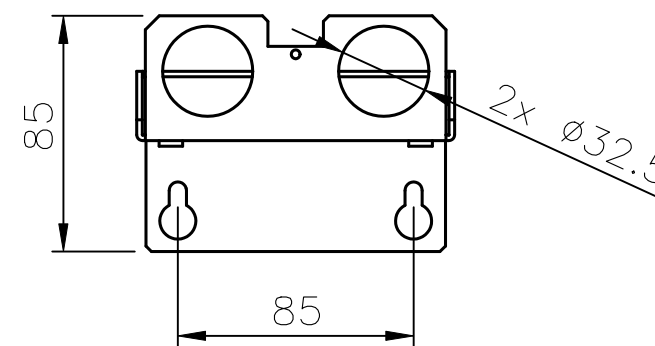

Dimensions toleranced according to ISO 2768-m						
Tolerance class	0.5 to 3	from 3 to 6	from 6 to 30	from 30 to 120	from 120 to 400	from 400 to 1000
m (middle)	±0.1	±0.1	±0.2	±0.3	±0.5	±0.8

drawn	12.05.10	Kornau	Kornau	scale	1:2
checked	12.05.10	Bremer	Bremer	formate	
	date	name	signature	DIN ISO 5456	
				all dimensions mm	

NEMA kit					
40A du/dt filter					
order number	130B4179	drawing number	Z791005006	modi.	0
				sheet	1/1
Please observe protection clause to DIN 34					