

WIRE COLOR SCHEME
 BLACK - LINE VOLTAGE
 RED - AC CONTROL
 WHITE - AC GROUND
 BLUE - DC CONTROL
 WHT/BLU - DC CONTROL COMMON
 GREEN - CHASSIS GROUND

* ALL CONTROL WIRES ARE BLUE EXCEPT WHERE NOTED. TO ELECTROMECHANICAL RELAY BOARD

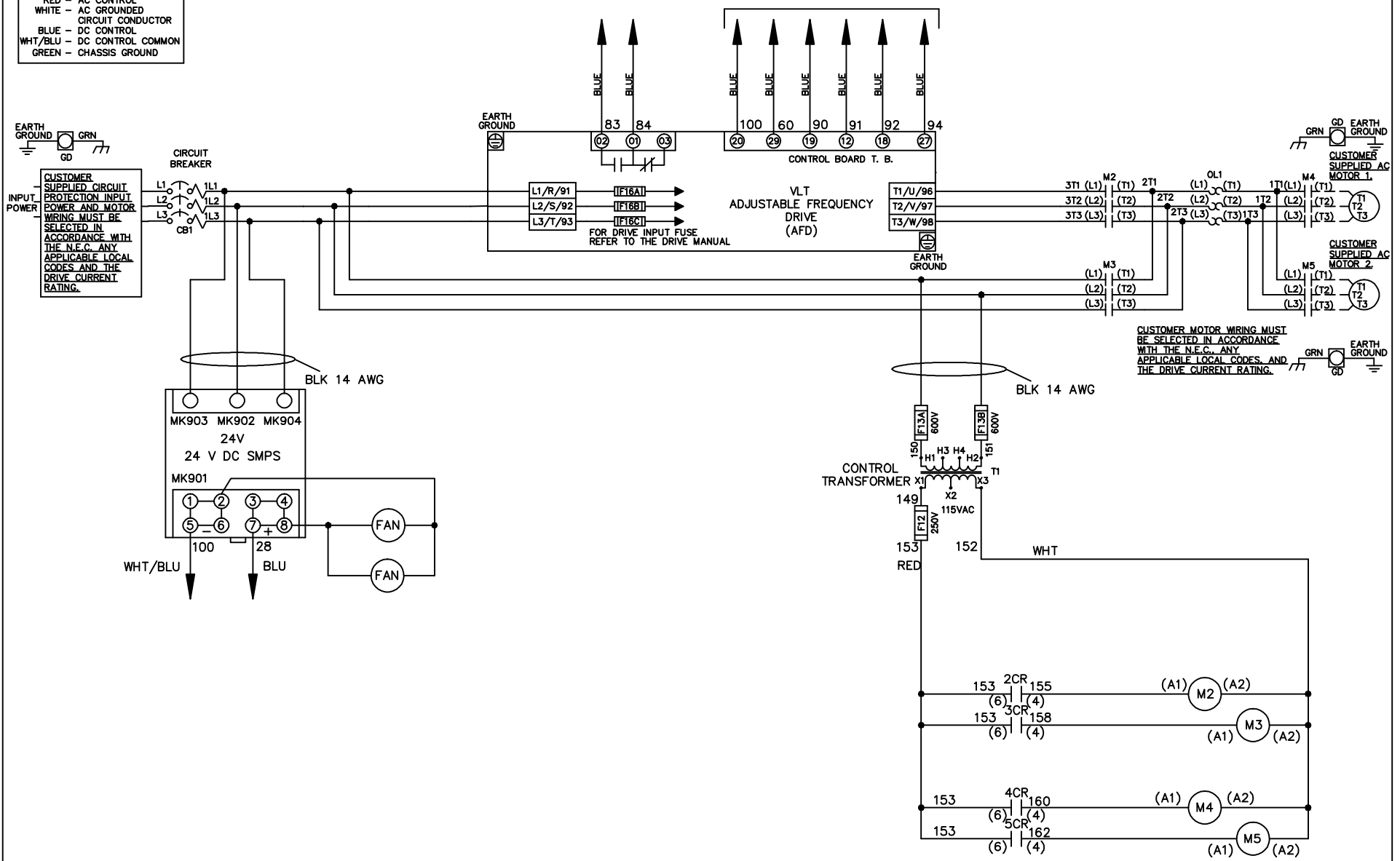

			- NOTICE -		DRN JNW 2/8/07		NAME208 VOLT,2C,CB ,DRIVE FUSE,EMB2,FRAME C2N12 ,NO REACTOR & DVDT,CMS		<i>Danfoss</i>	
A	SP08061	10/08	THIS DOCUMENT CONTAINS PROPRIETARY INFORMATION OF DANFOSS DRIVES. IT IS LOANED BY DANFOSS DRIVES SUBJECT TO THE CONDITIONS THAT IT AND THE INFORMATION EMBODIED THEREIN SHALL BE USED ONLY FOR RECORD AND REFERENCE PURPOSES. SHALL NOT BE USED OR CAUSED TO BE USED IN ANY WAY PREJUDICIAL TO THE INTERESTS OF DANFOSS DRIVES. SHALL NOT BE REPRODUCED OR COPIED IN WHOLE OR IN PART, OR DISCLOSED TO ANYONE WITHOUT THE DIRECT WRITTEN PERMISSION OF DANFOSS DRIVES AND SHALL BE RETURNED UPON REQUEST.			APR	MODEL	PAGE 1 OF 2	SIZE A	DWG NO. 174U1949
REV	ECN	DATE								

