

			-NOTICE-		DRN JNW 2/14/07		NAME 230 VOLT,2C,CB ,DRIVE FUSE,ECB,FRAME C2N1_ ,DVDT,SINGLE MTR		THE TRANE COMPANY A DIVISION OF AMERICAN STANDARD INC.	
A	SP08061	10/08	THIS DRAWING IS PROPRIETARY AND SHALL NOT BE COPIED OR ITS CONTENTS DISCLOSED TO OUTSIDE PARTIES WITHOUT THE WRITTEN CONSENT OF THE TRANE COMPANY			APR	MODEL	PAGE 1 OF 2	SIZE A	DWG NO. 174U5684
REV	ECN	DATE								

REV	ECN	DATE
A	SP08066	10/08

-NOTICE-
THIS DRAWING IS PROPRIETARY AND SHALL NOT BE COPIED OR ITS CONTENTS DISCLOSED TO OUTSIDE PARTIES WITHOUT THE WRITTEN CONSENT OF THE TRANE COMPANY

DRN JUNW
2/14/07
APR

MODEL NAME 230 VOLT, 2C, CB
, DRIVE FUSE, ECB, FRAME C2N1
, DVD1, SINGLE MTR

PAGE 2 OF 2

SIZE A

DWG NO. 174U5684

CUSTOMER CONNECTIONS X56, X57, X59
CLASS 2 POWER SOURCE
REQUIRED FOR FIELD CONNECTION
USE CLASS 1 CONDUCTORS
CONDUCTOR SIZE 28-14 AWG

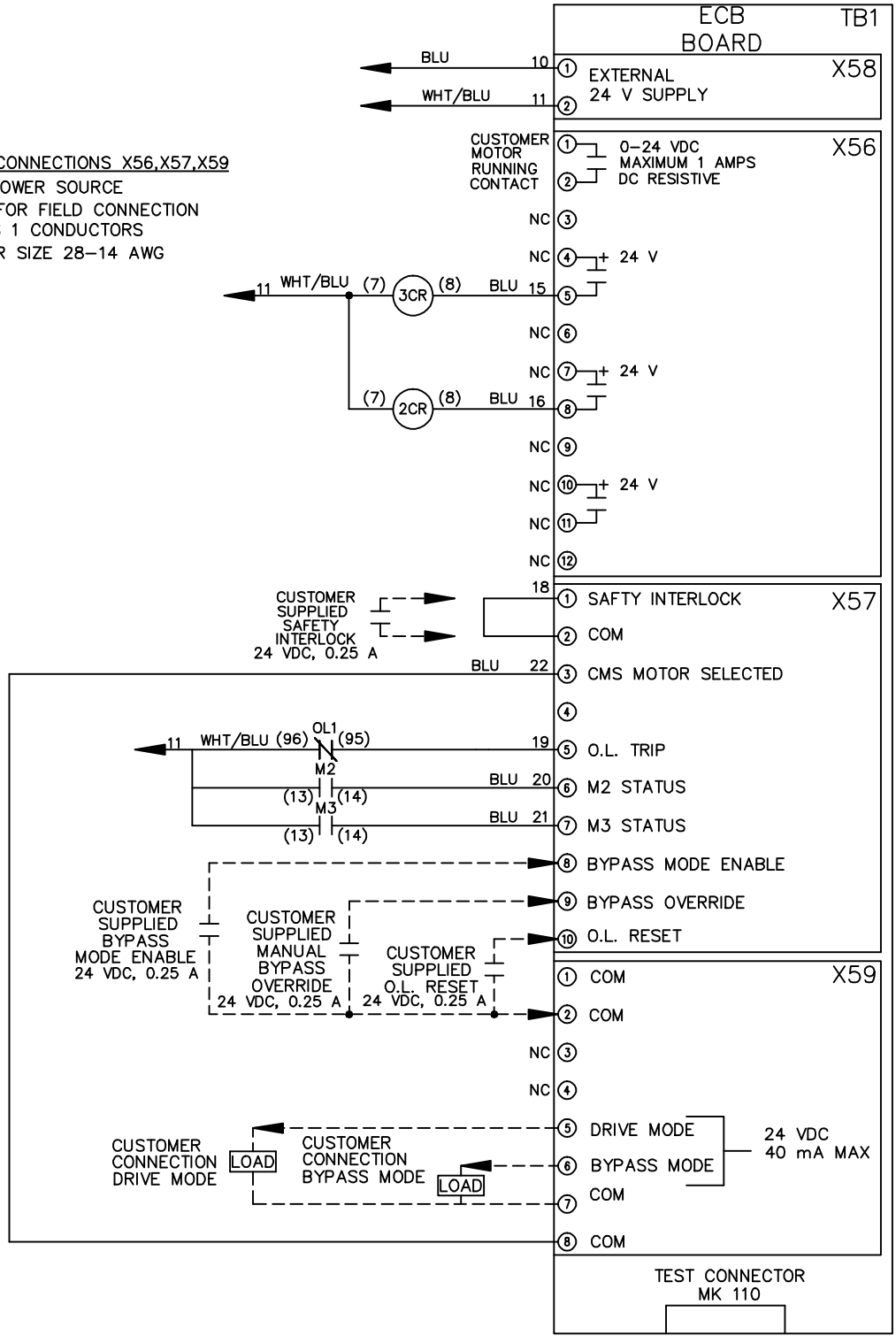

THE TRANE COMPANY
A DIVISION OF
AMERICAN STANDARD INC.