

WIRE COLOR SCHEME
 BLACK - LINE VOLTAGE
 RED - AC CONTROL
 WHITE - AC GROUNDED
 CIRCUIT CONDUCTOR
 BLUE - DC CONTROL
 WHT/BLU - DC CONTROL COMMON
 GREEN - CHASSIS GROUND

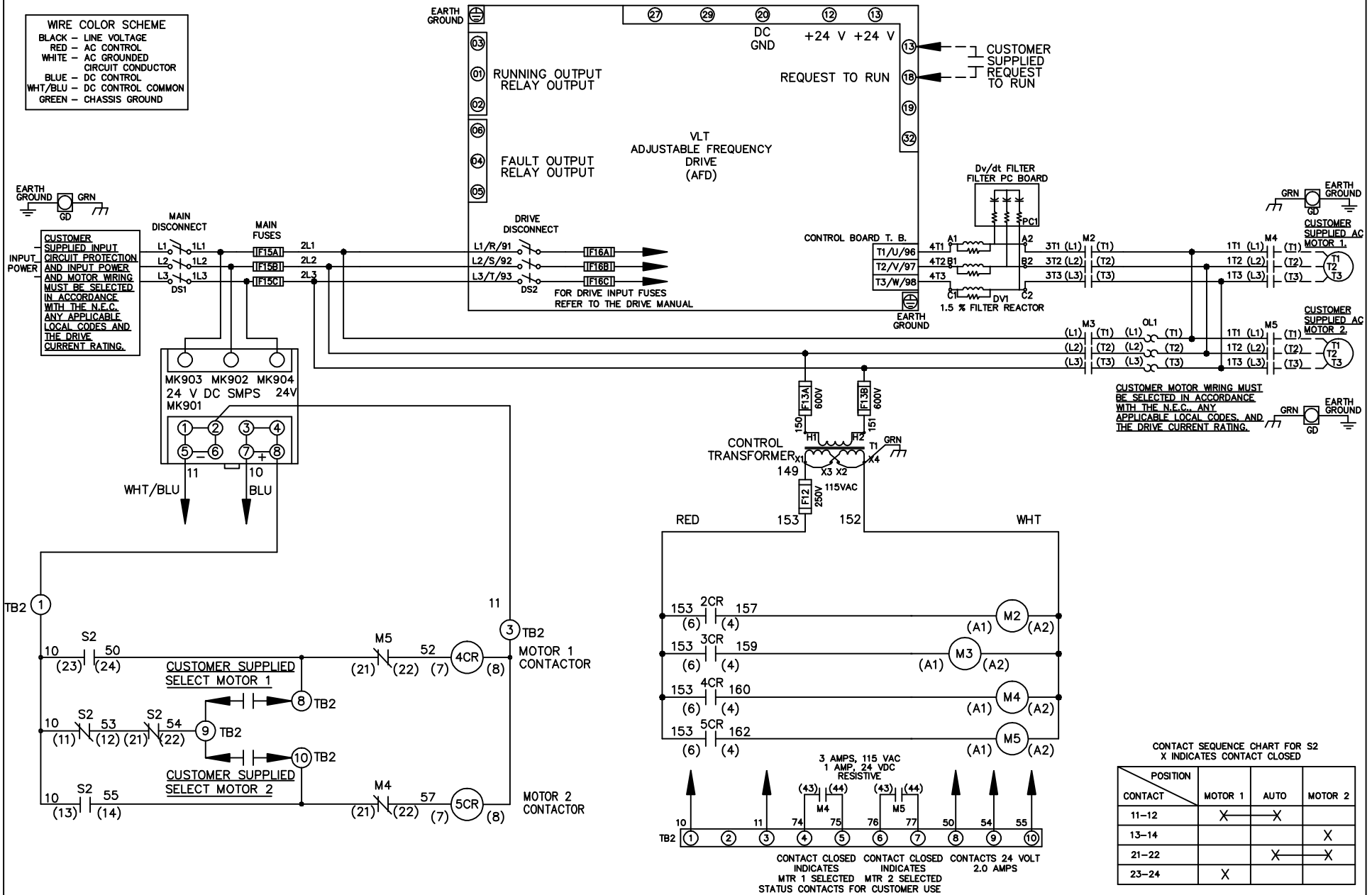

REV	ECN	DATE
A	SP08061	10/08

-NOTICE-
 THIS DRAWING IS PROPRIETARY AND SHALL NOT BE COPIED OR ITS CONTENTS DISCLOSED TO OUTSIDE PARTIES WITHOUT THE WRITTEN CONSENT OF THE TRANE COMPANY

DRN JNW
 2/14/07
 APR

NAME 600 VOLT, 2C, MAIN & DRIVE DISC
 , MAIN FUSE, ECB, FRAME C2N1_
 , DVDT, CMS
 MODEL

THE TRANE COMPANY
 A DIVISION OF
 AMERICAN STANDARD INC.
 PAGE 1 OF 2
 SIZE A
 DWG NO. 174U6134

REV	ECN	DATE
A	SP08066	10/08

-NOTICE-
THIS DRAWING IS PROPRIETARY AND SHALL NOT BE COPIED OR ITS CONTENTS DISCLOSED TO OUTSIDE PARTIES WITHOUT THE WRITTEN CONSENT OF THE TRANE COMPANY

DRN JUNW
2/14/07
APR

NAME 600 VOLT, 2C, MAIN&DRIVE DISC
, MAIN FUSE, ECB, FRAME C2N1
, DVDT, CMS

MODEL

PAGE 2 OF 2

SIZE A

DWG NO. 174U6134

THE TRANE COMPANY
A DIVISION OF
AMERICAN STANDARD INC.

CUSTOMER CONNECTIONS X56, X57, X59
CLASS 2 POWER SOURCE
REQUIRED FOR FIELD CONNECTION
USE CLASS 1 CONDUCTORS
CONDUCTOR SIZE 28-14 AWG

