

WIRE COLOR SCHEME
 BLACK - LINE VOLTAGE
 RED - AC CONTROL
 WHITE - AC GROUNDED
 BLUE - CIRCUIT CONDUCTOR
 BLUE - DC CONTROL
 WHT/BLU - DC CONTROL COMMON
 GREEN - CHASSIS GROUND

* ALL CONTROL WIRES ARE BLUE EXCEPT WHERE NOTED. TO ELECTROMECHANICAL RELAY BOARD

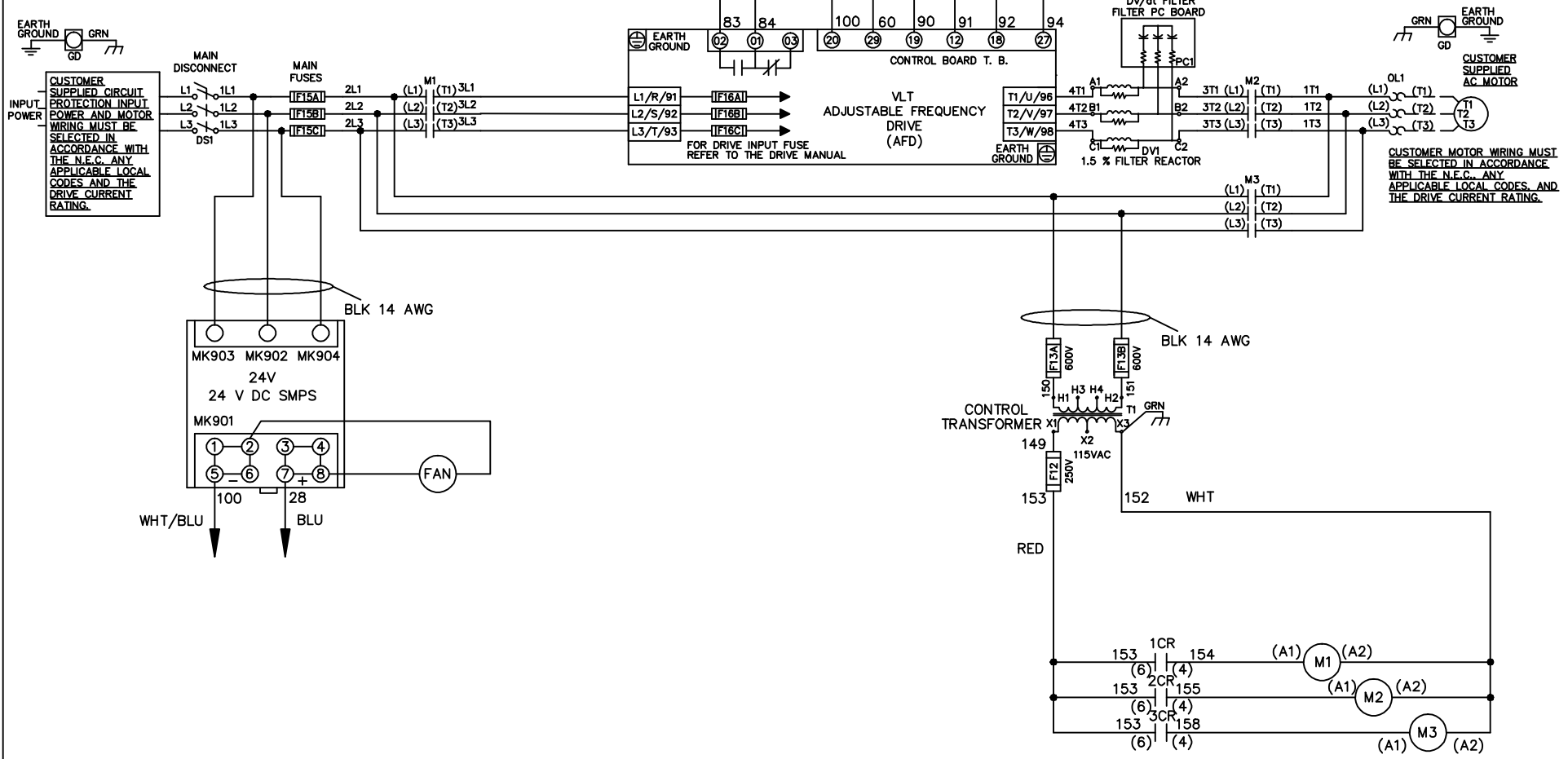

			-NOTICE-		DRN JNW 2/14/07		NAME 208 VOLT, 3C, MAIN DISC , MAIN FUSE, EMB2, FRAME C2N12 , DVDT, SINGLE MTR		THE TRANE COMPANY A DIVISION OF AMERICAN STANDARD INC.	
A	SP08061	10/08	THIS DRAWING IS PROPRIETARY AND SHALL NOT BE COPIED OR ITS CONTENTS DISCLOSED TO OUTSIDE PARTIES WITHOUT THE WRITTEN CONSENT OF THE TRANE COMPANY			APR	MODEL	PAGE 1 OF 2	SIZE A	DWG NO. 174U8446
REV	ECN	DATE								

REV	ECN	DATE
A	SP08066	10/08

CONTACT	POSITION	DRIVE	OFF	BYPASS	TEST
1-2		X			X
3-4				X	X
5-6		X			
7-8					X

CONTACT SEQUENCE CHART FOR S1
X INDICATES CONTACT CLOSED

-NOTICE-
 THIS DRAWING IS PROPRIETARY AND SHALL NOT BE COPIED OR ITS CONTENTS DISCLOSED TO OUTSIDE PARTIES WITHOUT THE WRITTEN CONSENT OF THE TRANE COMPANY

DRN JNW
2/14/07
APR

NAME 208 VOLT, 3C, MAIN DISC
MAIN FUSE, EM B2, FRAME C2N12
D, VDT, SINGLE MTR

MODEL
PAGE 2 OF 2
SIZE A
DWG NO. 174U8446



CUSTOMER CONNECTIONS X55, X56, X58
CLASS 2 POWER SOURCE
REQUIRED FOR FIELD CONNECTION
USE CLASS 1 CONDUCTORS
CONDUCTOR SIZE 28-14 AWG

ELECTROMECHANICAL BOARD



CUSTOMER SETTING
AUTOMATIC BYPASS TIME SELECT

- ONLY # 1 ON 30 SECONDS
- ONLY # 2 ON 60 SEC.
- ONLY # 3 ON 300 SEC
- ALL ON 15 SEC.
- ALL OFF NO AUTO BYPASS (FACTORY DEFAULT)

THE TRANE COMPANY
A DIVISION OF
AMERICAN STANDARD INC.