

**WIRE COLOR SCHEME**  
 BLACK - LINE VOLTAGE  
 RED - AC CONTROL  
 WHITE - AC GROUNDED  
 CIRCUIT CONDUCTOR  
 BLUE - DC CONTROL  
 WHI/BLU - DC CONTROL COMMON  
 GREEN - CHASSIS GROUND

\* ALL CONTROL WIRES ARE BLUE EXCEPT WHERE NOTED.

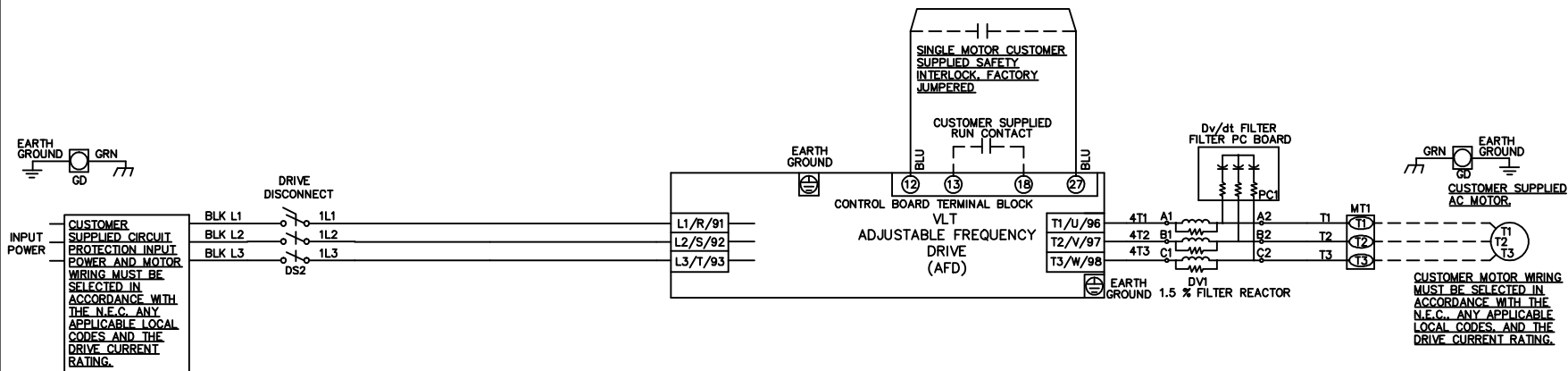

-NOTICE-

THIS DRAWING IS PROPRIETARY AND SHALL NOT BE COPIED OR ITS CONTENTS DISCLOSED TO OUTSIDE PARTIES WITHOUT THE WRITTEN CONSENT OF THE TRANE COMPANY

DRN JNW  
2/14/07

APR

NAME 600 VOLT,NB,DRIVE DISC  
 ,NO FUSE,NO CNTRL,FRAME C2N1\_  
 ,DVDT,SINGLE MTR

MODEL

PAGE 1 OF 1

SIZE A

DWG NO.

THE TRANE COMPANY  
 A DIVISION OF  
 AMERICAN STANDARD INC.

174U8924

A	SP08061	10/08
REV	ECN	DATE