

WIRE COLOR SCHEME
 BLACK - LINE VOLTAGE
 RED - AC CONTROL
 WHITE - AC GROUNDED
 CIRCUIT CONDUCTOR
 BLUE - DC CONTROL
 WHT/BLU - DC CONTROL COMMON
 GREEN - CHASSIS GROUND

* ALL CONTROL WIRES ARE BLUE EXCEPT WHERE NOTED. TO ELECTROMECHANICAL RELAY BOARD

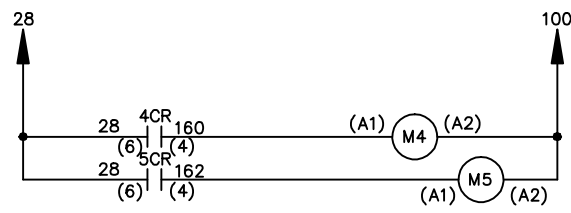
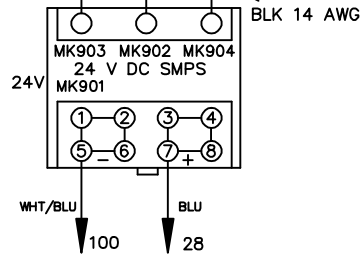
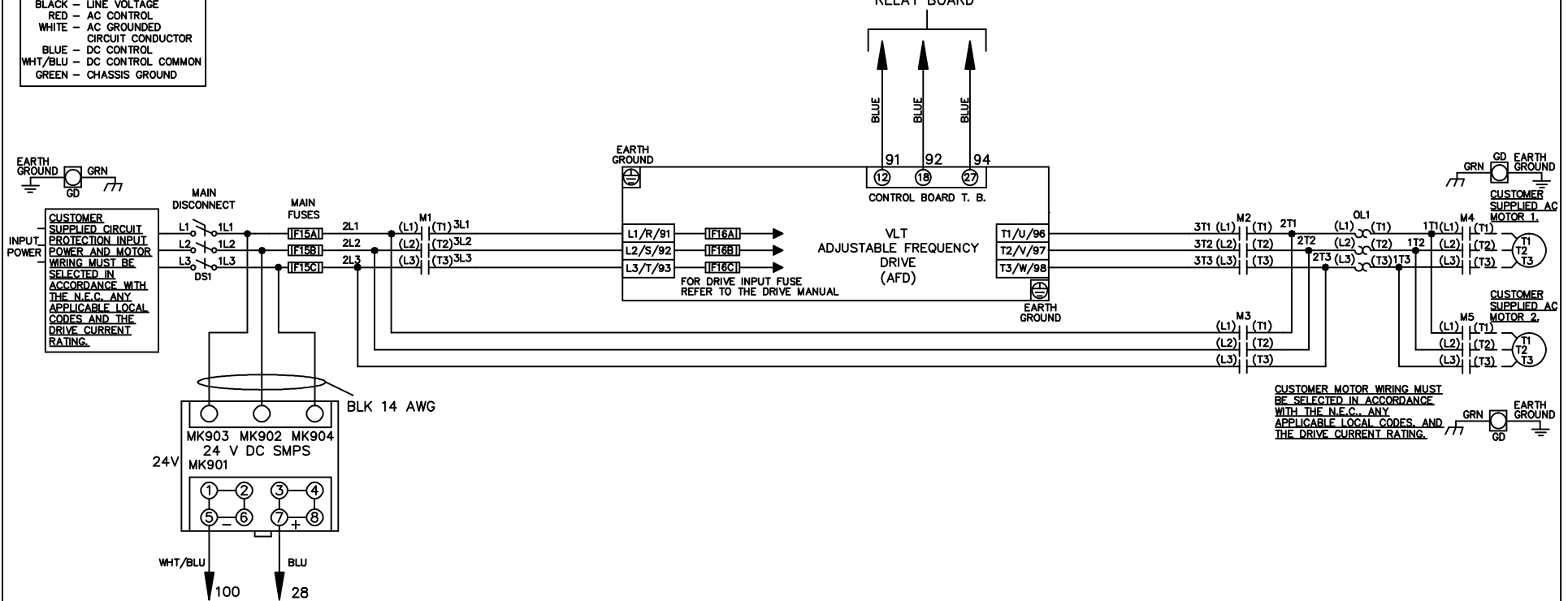

CUSTOMER MOTOR WIRING MUST BE SELECTED IN ACCORDANCE WITH THE N.E.C. ANY APPLICABLE LOCAL CODES, AND THE DRIVE CURRENT RATING.

			- NOTICE -		DRN JNW 2/14/07		NAME 208-600VOLT,3C,MAIN DISC ,MAIN FUSE,EMB1,FRAME B2-C1 ,NO REACTOR & DVDT,CMS		<i>Danfoss</i>	
A	SP08061	10/08	THIS DOCUMENT CONTAINS PROPRIETARY INFORMATION OF DANFOSS DRIVES. IT IS LOANED BY DANFOSS DRIVES SUBJECT TO THE CONDITIONS THAT IT AND THE INFORMATION EMBODIED THEREIN SHALL BE USED ONLY FOR RECORD AND REFERENCE PURPOSES, SHALL NOT BE USED OR CAUSED TO BE USED IN ANY WAY PREJUDICIAL TO THE INTERESTS OF DANFOSS DRIVES, SHALL NOT BE REPRODUCED OR COPIED IN WHOLE OR IN PART, OR DISCLOSED TO ANYONE WITHOUT THE DIRECT WRITTEN PERMISSION OF DANFOSS DRIVES AND SHALL BE RETURNED UPON REQUEST.			APR	MODEL	PAGE 1 OF 2	SIZE A	DWG NO. 174U9706
REV	ECN	DATE								

REV	ECON	DATE
A	SP08066	10/08

THIS DOCUMENT CONTAINS PROPRIETARY INFORMATION OF DANFOSS DRIVES. IT IS LOANED BY DANFOSS DRIVES SUBJECT TO THE CONDITIONS THAT IT AND THE INFORMATION EMBODIED THEREIN SHALL BE USED ONLY FOR RECORD AND REFERENCE PURPOSES, SHALL NOT BE USED OR CAUSED TO BE USED IN ANY WAY PREJUDICIAL TO THE INTERESTS OF DANFOSS DRIVES, SHALL NOT BE REPRODUCED OR COPIED IN WHOLE OR IN PART, OR DISCLOSED TO ANYONE WITHOUT THE DIRECT WRITTEN PERMISSION OF DANFOSS DRIVES AND SHALL BE RETURNED UPON REQUEST.

DRN	JNW
APR	2/14/07

NAME 208-600VOLT,3C,MAIN DISC
 ,MAIN FUSE,EMB1,FRAME B2-C1
 ,NO REACTOR & DVDI,CMS

MODEL
 PAGE 2 OF 2
 SIZE A
 DWG NO. 174U9706

CONTACT POSITION	DRIVE	OFF	BYPASS	TEST
1-2	X			
3-4			X	
5-6				X
7-8				X

CONTACT SEQUENCE CHART FOR S1
 X INDICATES CONTACT CLOSED

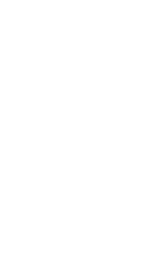
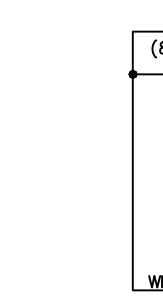
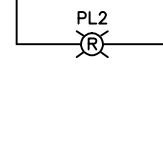
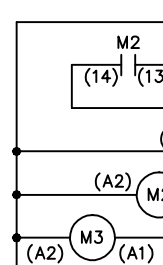

CONTACT POSITION	MOTOR 1	AUTO	MOTOR 2
11-12	X	X	
13-14			X
21-22			X
23-24	X		

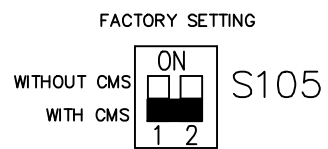
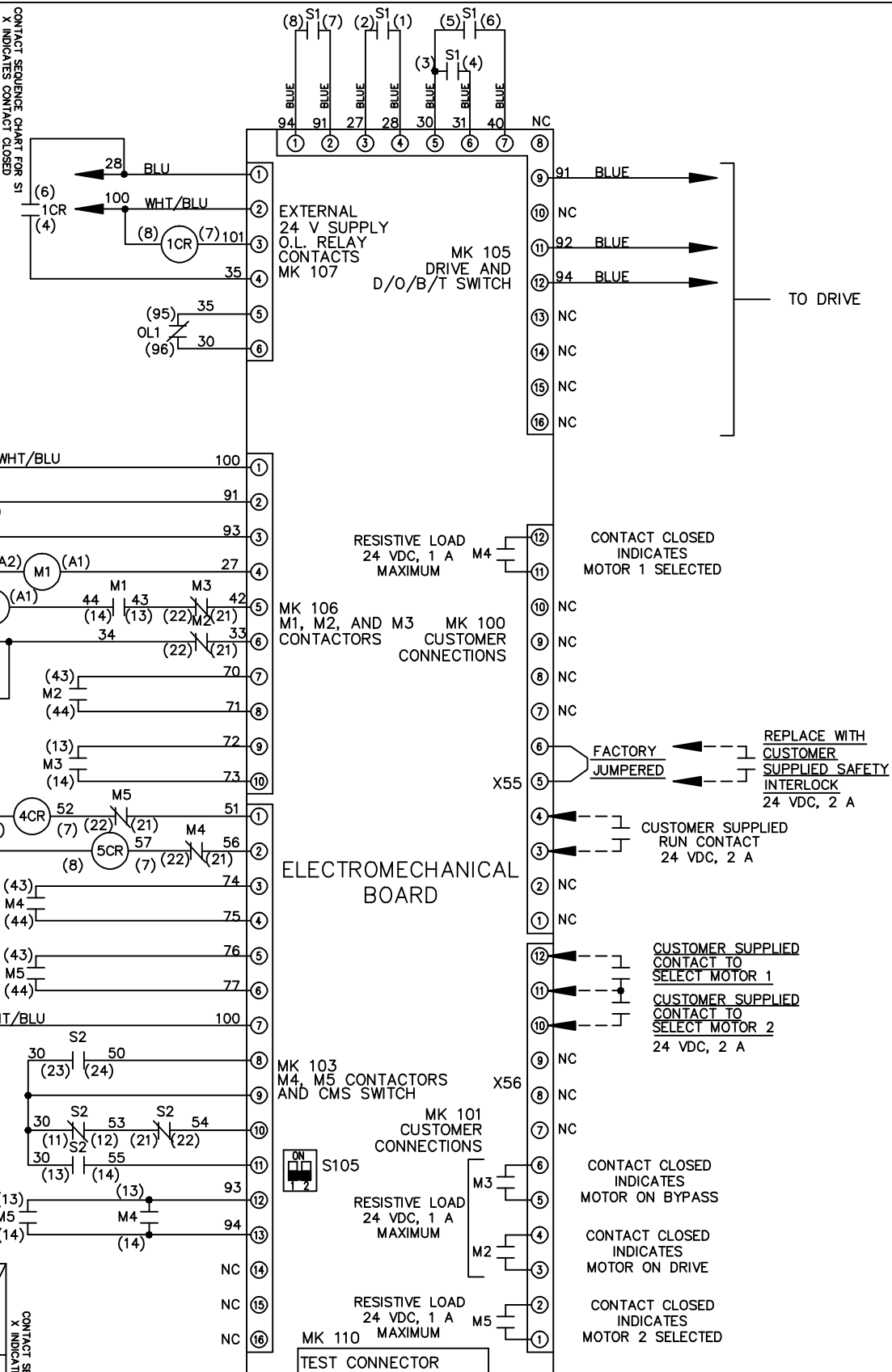

CUSTOMER CONNECTIONS X55,X56
 CLASS 2 POWER SOURCE
 REQUIRED FOR FIELD CONNECTION
 USE CLASS 1 CONDUCTORS
 CONDUCTOR SIZE 28-14 AWG

