

additional informations:

Inductance : 1,95mH
 Rated current : 3,8A
 Rated voltage : 3x 500V
 Ambient temperature : max. 45°C

earth terminal
 6.3x0.8 faston

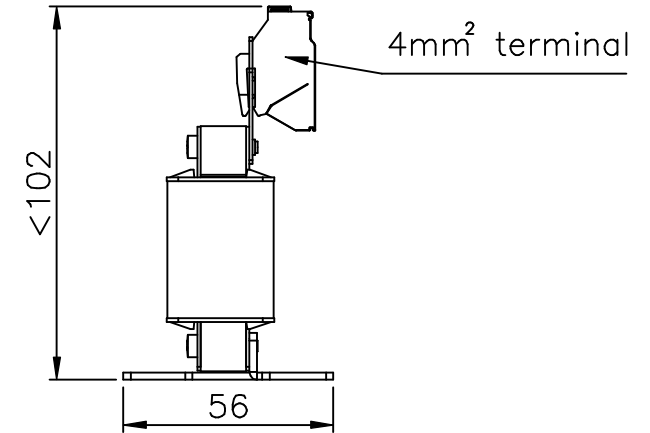
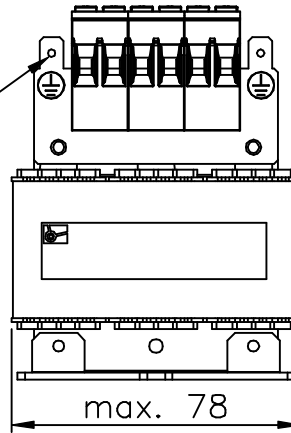

label:

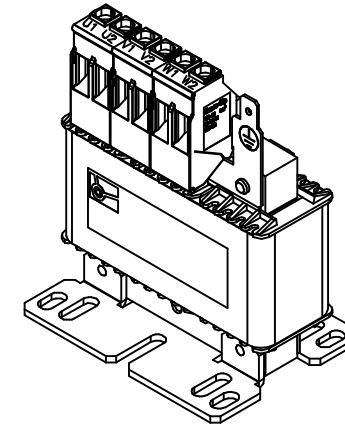
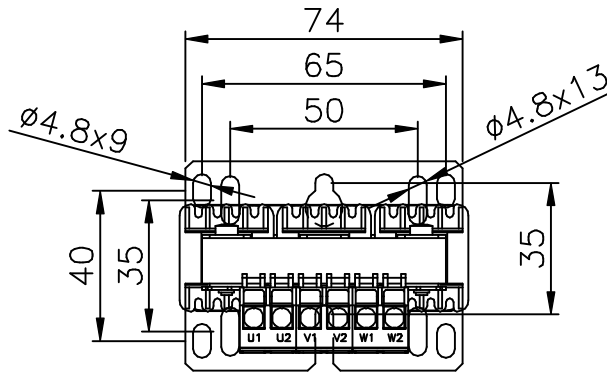

b	10.02.14	Schr./ Fle.	order number and MMC number changed
a	14.02.13	Schr./ Kor.	label updated, Terminalmarking included
	date	name	amendment

Dimensions toleranced according to ISO 2768-m						
Tolerance class	0,5 to 3	from 3 to 6	from 6 to 30	from 30 to 120	from 120 to 400	from 400 to 1000
m (middle)	±0.1	±0.1	±0.2	±0.3	±0.5	±0.8

drawn	17.10.12	Kornau	Kornau	scale 1:2
checked	18.10.12	Lauer	Lauer	format A4
	date	name	signature	
				DIN ISO 5456
				all dimensions mm

Dimensions B 1101133
 Line Reactor LR3/x 3,8A – IP00

order number	drawing number	modi.	sheet
175U0298	Z791210004	b	1/1

Please observe protection clause to ISO 16016