

- NOTICE -
 THIS DOCUMENT CONTAINS PROPRIETARY INFORMATION OF DANFOSS DRIVES. IT IS LOANED BY DANFOSS DRIVES SUBJECT TO THE CONDITIONS THAT IT AND THE INFORMATION EMBODIED THEREIN SHALL BE USED ONLY FOR RECORD AND REFERENCE PURPOSES. SHALL NOT BE USED OR CAUSED TO BE USED IN ANY WAY PREJUDICIAL TO THE INTERESTS OF DANFOSS DRIVES. SHALL NOT BE REPRODUCED OR COPIED IN WHOLE OR IN PART OR DISCLOSED TO ANYONE WITHOUT THE DIRECT WRITTEN PERMISSION OF DANFOSS DRIVES, AND SHALL BE RETURNED UPON REQUEST.

REVISION HISTORY			
REV	ECN NUMBER	ENTRY BY	DATE
002	LP11027	DK	5/11/2011

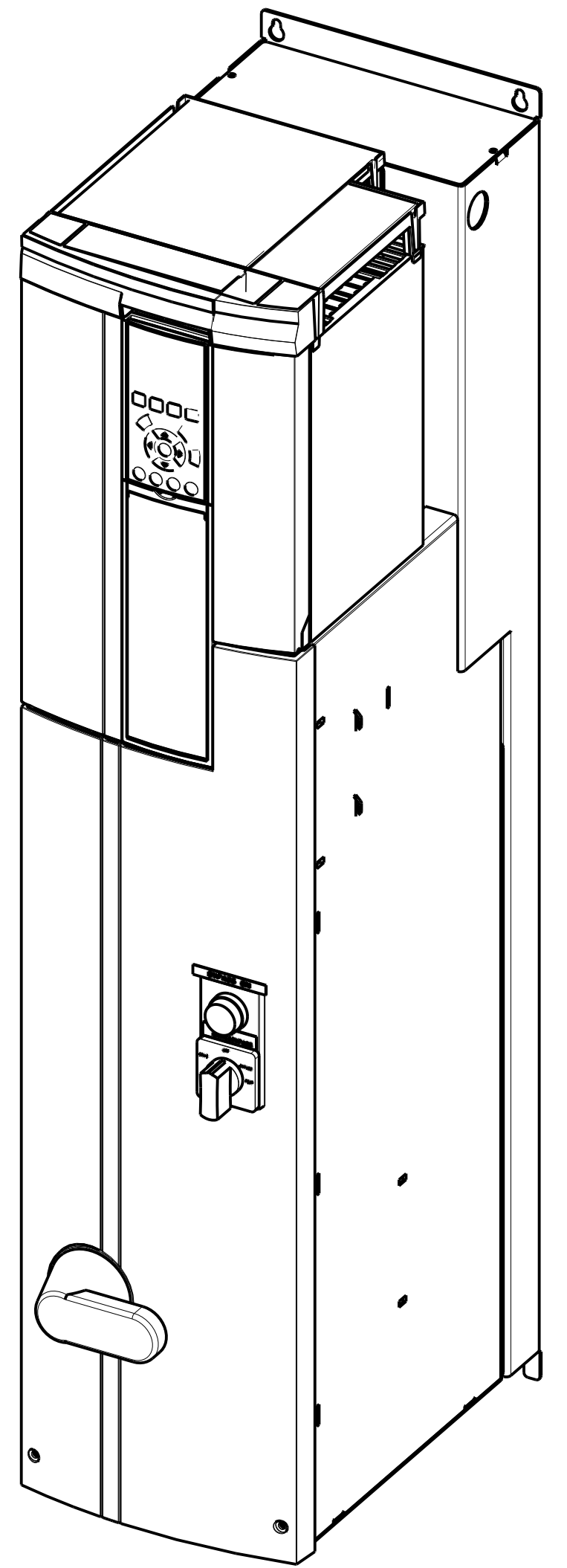
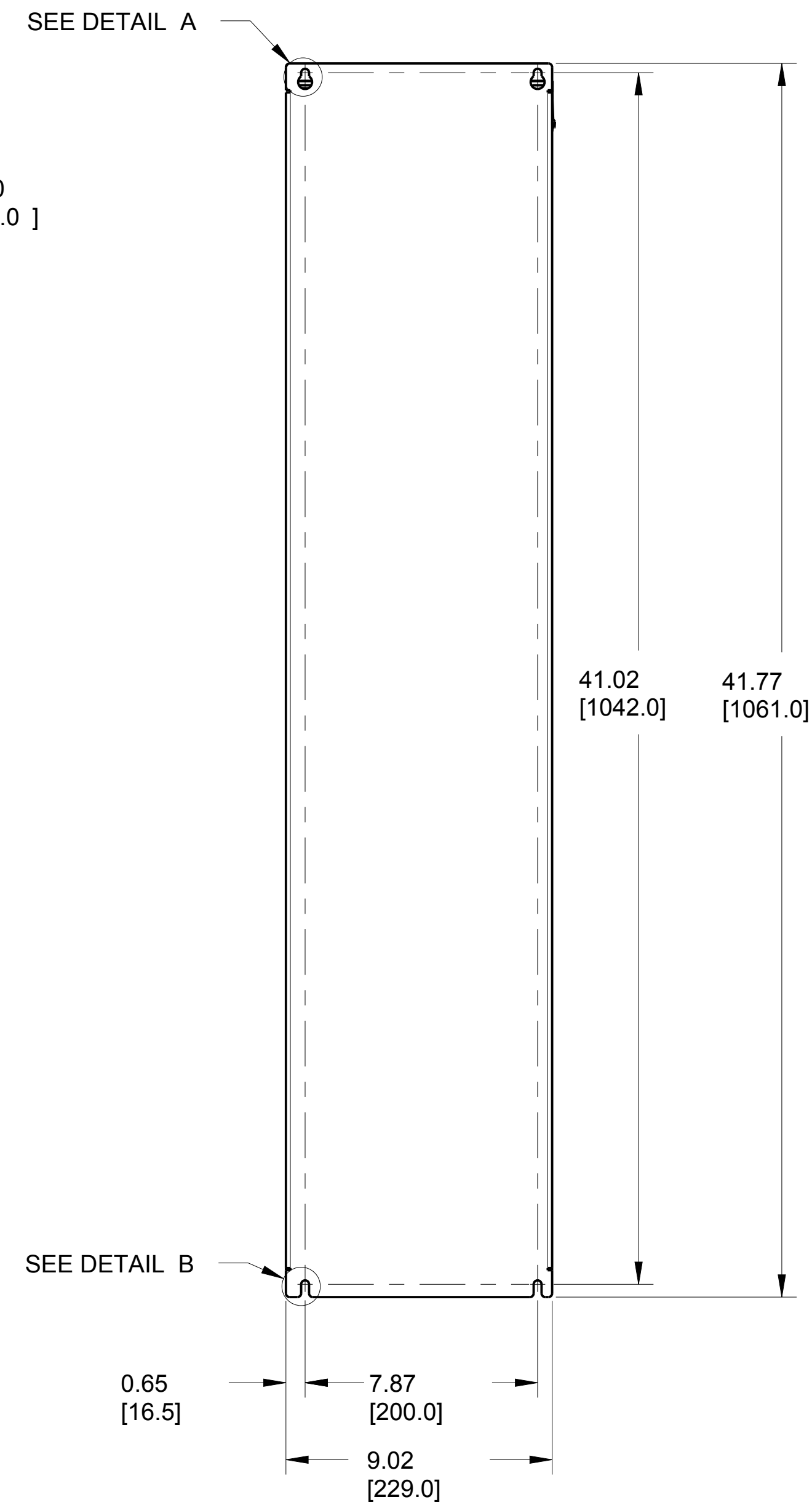
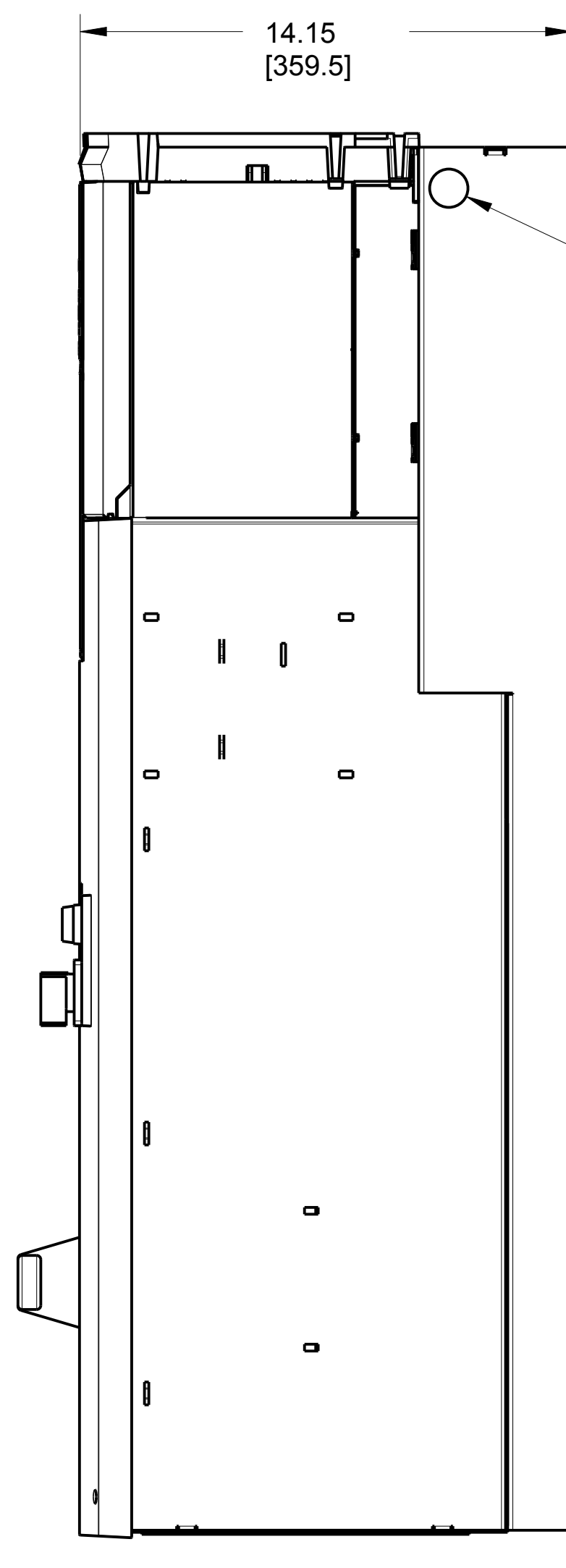
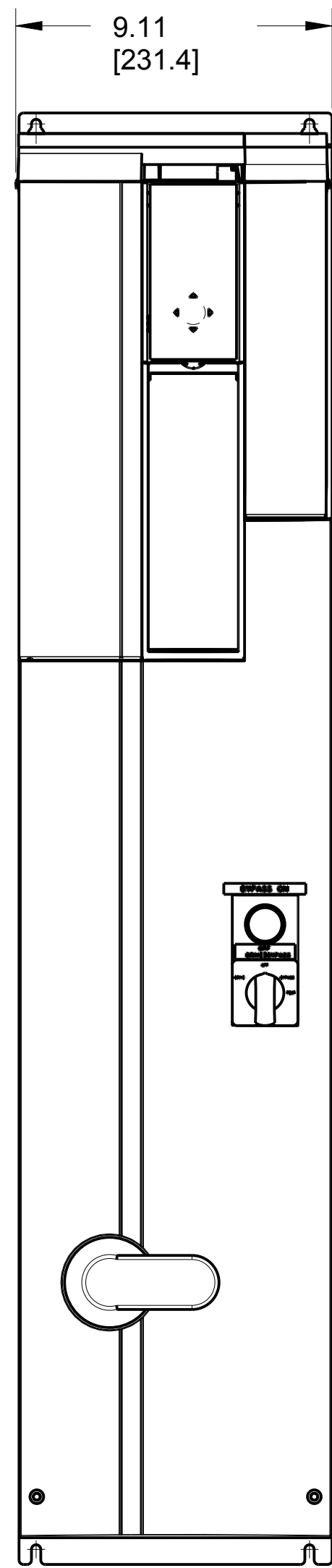
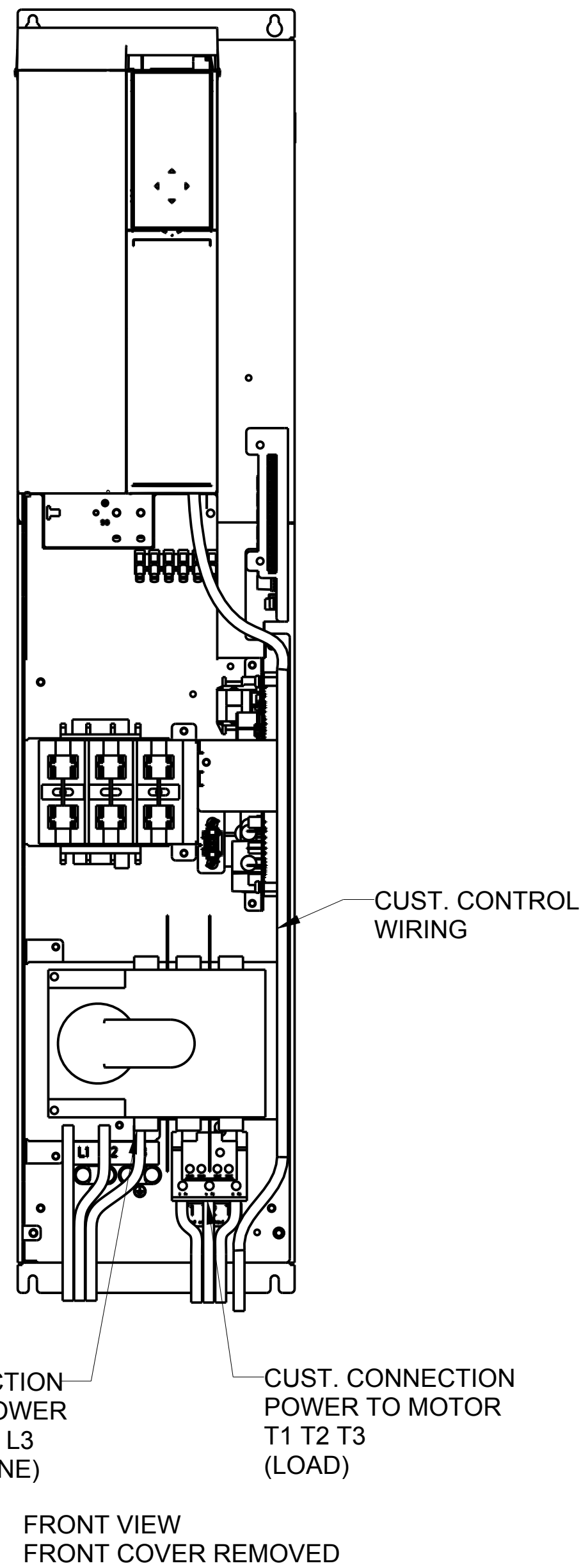

CUST. CONNECTION INPUT POWER L1 L2 L3 (LINE)
 CUST. CONNECTION POWER TO MOTOR T1 T2 T3 (LOAD)

FRONT VIEW
 FRONT COVER REMOVED

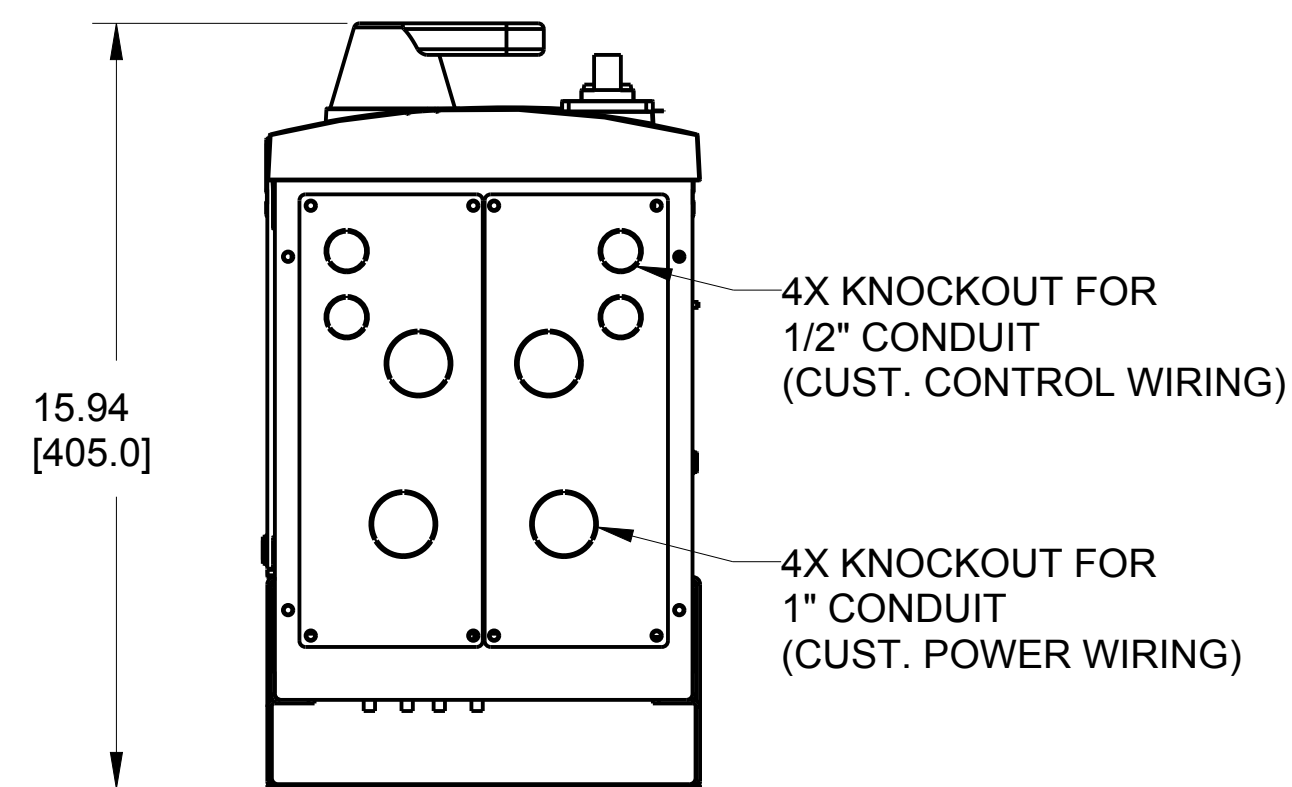
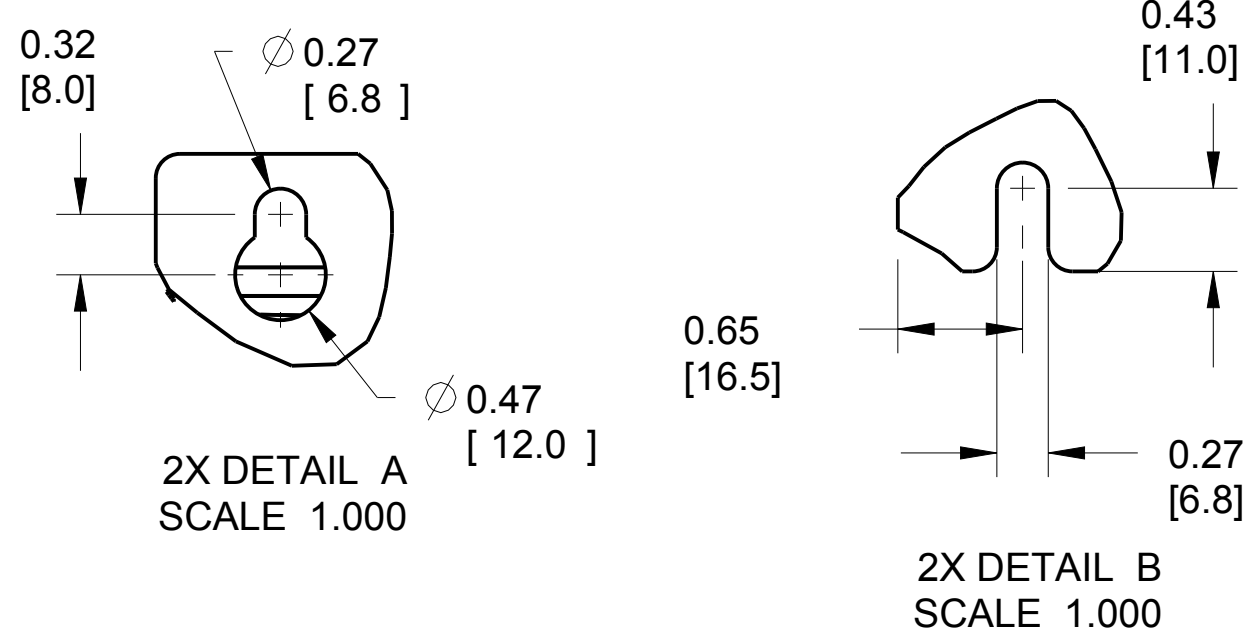

FRAME SIZE P2		
VOLTAGE	HP	KW
208	7.5	5.5
	10	7.5
	15	11
230	7.5	5.5
	10	7.5
	15	11
460	15	11
	20	15
	25	18
575	15	11
	20	15
	25	18

CLEARANCE REQUIREMENT FOR AIR FLOW COOLING:
 THE UNIT MUST BE INSTALLED VERTICALLY WITH THE MINIMUM CLEARANCE OF 7.87" [200mm] ON THE BOTTOM, 2.00" [50.8mm] ON THE TOP AND 1.50" [38.1mm] ON EITHER SIDE FOR UNIT COOLING.

UNLESS OTHERWISE SPECIFIED INTERPRET DIM. AND TOL. PER ASME Y14.5M-1994		PROPERTIES		TITLE	
.X± 0.4 .XX± 0.20 ∠ ± 0.5		MATERIAL		 4401 N. BELL SCHOOL RD. LOVES PARK, ILLINOIS 61111 USA (615) 635-6600 FAX (615) 635-9000	
DIM. ARE IN MILLIMETERS WEIGHTS ARE IN KILOGRAMS		FINISH			
THIRD ANGLE PROJECTION		THICKNESS		EST. WEIGHT	84.0 Lbs [38.1 Kg]
		APPROVALS	INITIALS	DATE	
		DRAWN	DK	12/20/10	
		CHECKED			
		ENGR			
		SCALE	D	MODEL	177R0231
		SCALE	0.250	DRAWING NO.	177R0201
				REV	002
				SHEET	1 OF 1