

WARNING!
 THE FOLLOWING TABLE LISTS THE PARAMETERS THAT ARE SET DIFFERENT FROM THE DRIVE DEFAULT SETTINGS. ADDITIONAL PARAMETER SETTINGS MAY BE REQUIRED FOR YOUR APPLICATION.

DRIVE PARAMETER SETTINGS

PARAMETER #	NAME	SETTING	VALUE
0-02	MOTOR SPEED UNIT	1	HZ
0-03	REGIONAL SETTINGS	1	NORTH AMERICA
1-03	TORQUE CHAR.	1	VARIABLE TORQUE
5-02	TERMINAL 29 TYPE	1	OUTPUT
5-11	TERMINAL 19	52	RUN PERMISSIVE
5-31	TERMINAL 29	5	RUNNING
5-40[0]	RELAY 1	160	NO ALARM
5-40[1]	RELAY 2	167	START COMMAND
14-20	RESET MODE	13	INFINITE AUTO REST

NOTES:

- * INDICATES COMPONENTS NOT SUPPLIED BY MANUFACTURER.
- REFER TO THE INSTALLATION AND OPERATION MANUAL FOR DRIVE FUNCTIONS AND PARAMETER SETTINGS.
- FEEDER CIRCUIT PROTECTION, INPUT POWER AND MOTOR WIRING MUST BE SELECTED IN ACCORDANCE WITH THE N.E.C., ANY APPLICATION LOCAL CODES AND THE LOAD CURRENT RATING.
- REPLACE JUMPER 'J1' WITH NORMALLY CLOSED SAFETY INTERLOCK CONTACT AS NECESSARY. CONTACT MUST BE RATED 1/4 HP @ 120VAC MINIMUM.
- PANEL MAY REQUIRE DERATING, CONSULT DRIVE MANUAL OR FACTORY FOR FOLLOWING CONDITIONS:
 - HIGHER SWITCHING FREQUENCY THAN DRIVE DEFAULT
 - HIGHER THAN PANEL LISTED AMBIENT TEMPERATURES
 - ELEVATION ABOVE 3300 FEET (1000 METERS)
 - LONG MOTOR LEAD LENGTHS
- WHEN MOTOR OVERLOADS SIZES ARE DIFFERENT, MOTOR 1 WILL BE THE LARGER OF THE TWO MOTORS

B			- NOTICE - THIS DOCUMENT CONTAINS PROPRIETARY INFORMATION OF DANFOSS DRIVES. IT IS LOANED BY DANFOSS DRIVES SUBJECT TO THE CONDITIONS THAT IT AND THE INFORMATION EMBODIED THEREIN SHALL BE USED ONLY FOR RECORD AND REFERENCE PURPOSES, SHALL NOT BE USED OR CAUSED TO BE USED IN ANY WAY PREJUDICIAL TO THE INTERESTS OF DANFOSS DRIVES, SHALL NOT BE REPRODUCED OR COPIED IN WHOLE OR IN PART, OR DISCLOSED TO ANYONE WITHOUT THE DIRECT WRITTEN PERMISSION OF DANFOSS DRIVES AND SHALL BE RETURNED UPON REQUEST.	DRN	NAME NEMA 3R,208V,2C ,MAIN & DRIVE DISC, MAIN & DRIVE FUSE ,3MB2,DUAL MOTOR,2 FAN			
A	SP10119	11/10		APR	MODEL	VLT	PAGE 1 OF 2	
DR	SP10076	09/10						
REV	ECN	DATE						

WIRE COLOR SCHEME	
BLACK	- LINE VOLTAGE
RED	- AC CONTROL
WHITE	- AC GROUNDED CIRCUIT CONDUCTOR
BLUE	- DC CONTROL
GREEN	- CHASSIS GROUND

TERMINAL IDENTIFICATION	
X	- DRIVE TERMINAL
⊗	- CUSTOMER TERMINAL

CUSTOMER DRY CONTACT RATINGS

RELAY	CONTACT RATING
CR1, CR2, CR6, CR8, CR9	5A @ 120VAC 1/10 HP @ 120VAC
M2, M3	10A @ 120/240VAC
UV	8A @ 120VAC 1/3 HP @ 120VAC
TD1	4A @ 250VAC
DRIVE RELAY 1 & 2	2A @ 240VAC

CONTACT SEQUENCE CHART FOR S1 X INDICATES CONTACT CLOSED				
CONTACT	POSITION	DRIVE	OFF	BYPASS
13-14				X
23-24		X		

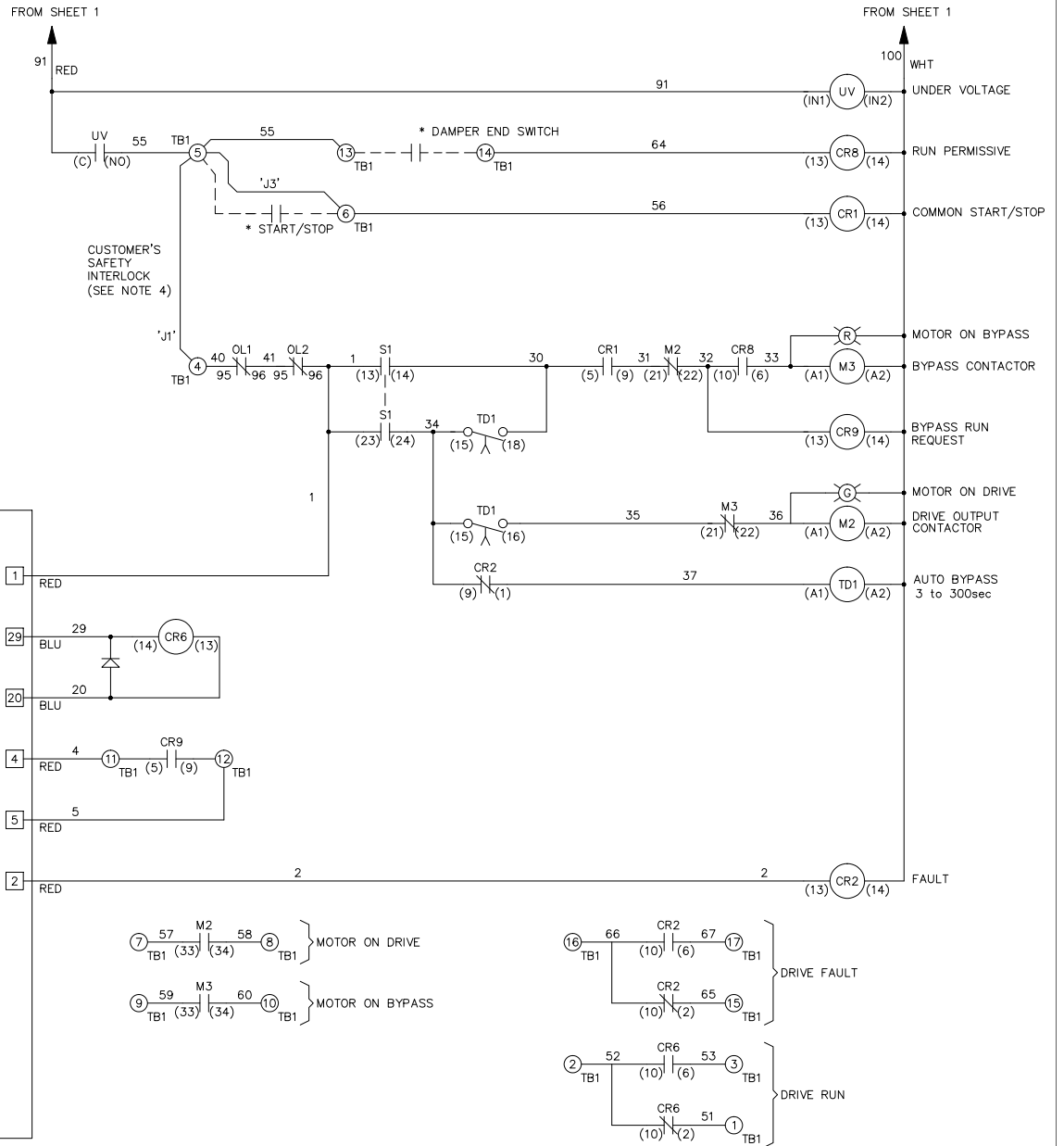
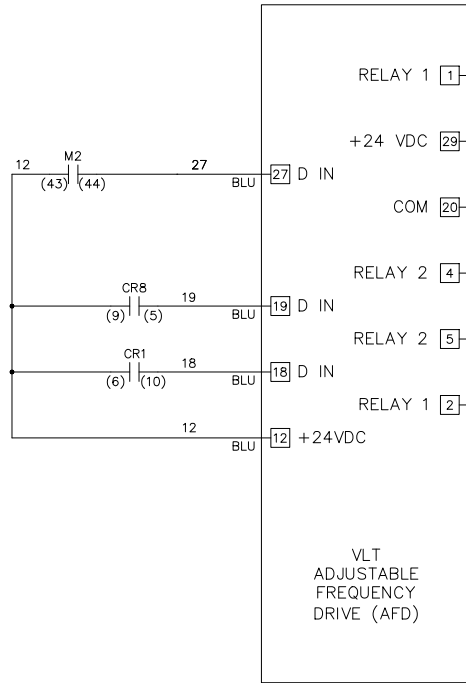

B		
A	SP10119	11/10
DR	SP10076	09/10
REV	ECN	DATE

- NOTICE -

THIS DOCUMENT CONTAINS PROPRIETARY INFORMATION OF DANFOSS DRIVES. IT IS LOANED BY DANFOSS DRIVES SUBJECT TO THE CONDITIONS THAT IT AND THE INFORMATION EMBODIED THEREIN SHALL BE USED ONLY FOR RECORD AND REFERENCE PURPOSES, SHALL NOT BE USED OR CAUSED TO BE USED IN ANY WAY PREJUDICIAL TO THE INTERESTS OF DANFOSS DRIVES, SHALL NOT BE REPRODUCED OR COPIED IN WHOLE OR IN PART, OR DISCLOSED TO ANYONE WITHOUT THE DIRECT WRITTEN PERMISSION OF DANFOSS DRIVES AND SHALL BE RETURNED UPON REQUEST.

DRN
DTM

APR
DTM

NAME
NEMA 3R,208V,2C
,MAIN & DRIVE DISC, MAIN & DRIVE FUSE
,3MB2,DUAL MOTOR,2 FAN

MODEL
VLT

PAGE 2 OF 2

SIZE
A

DWG NO. 185B0997

