

WIRE COLOR SCHEME
 BLACK - LINE VOLTAGE
 RED - AC CONTROL
 WHITE - AC GROUNDED
 CIRCUIT CONDUCTOR
 BLUE - DC CONTROL
 GREEN - CHASSIS GROUND

TERMINAL IDENTIFICATION

□ - DRIVE TERMINAL
 ⊗ - CUSTOMER TERMINAL

CUSTOMER DRY CONTACT RATINGS

RELAY	CONTACT RATING
CR1, CR6	5A @ 120VAC 1/10 HP @ 120VAC
M2, M3	10A @ 120/240VAC

CONTACT SEQUENCE CHART FOR S1
 X INDICATES CONTACT CLOSED

POSITION	DRIVE	OFF	BYPASS
13-14			X
23-24	X		

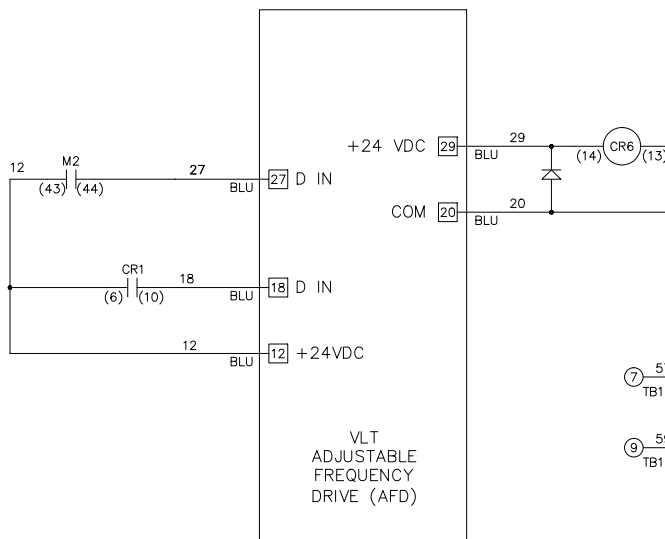

B			<p align="center">-NOTICE-</p> <p>THIS DRAWING IS PROPRIETARY AND SHALL NOT BE COPIED OR ITS CONTENTS DISCLOSED TO OUTSIDE PARTIES WITHOUT THE WRITTEN CONSENT OF THE TRANE COMPANY</p>	DRN	NAME			THE TRANE COMPANY	
A	SP10119	11/10		DTM	NEMA 3R,480V,2C ,MAIN & DRIVE DISC, MAIN & DRIVE FUSE ,3MB1,IR,DUAL MOTOR,2 FAN			A DIVISION OF AMERICAN STANDARD INC.	
DR	SP10076	09/10		APR	MODEL	PAGE	SIZE	DWG NO.	
REV	ECN	DATE		DTM	TR200	2 OF 2	A	185B3670	