

WIRE COLOR SCHEME
 BLACK - LINE VOLTAGE
 RED - AC CONTROL
 WHITE - AC GROUNDED
 CIRCUIT CONDUCTOR
 BLUE - DC CONTROL
 GREEN - CHASSIS GROUND

TERMINAL IDENTIFICATION
 (X) - DRIVE TERMINAL
 (X) - CUSTOMER TERMINAL

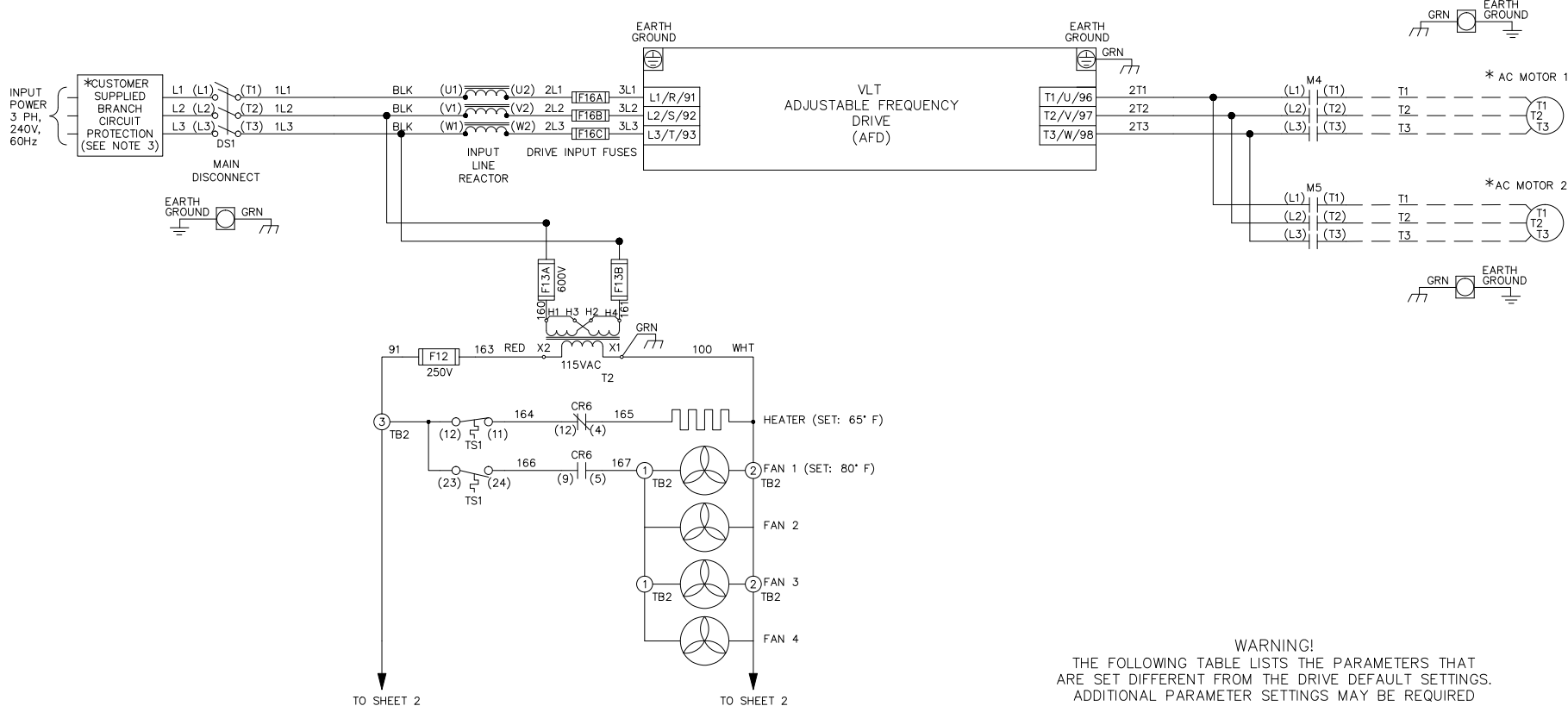

WARNING!
 THE FOLLOWING TABLE LISTS THE PARAMETERS THAT ARE SET DIFFERENT FROM THE DRIVE DEFAULT SETTINGS. ADDITIONAL PARAMETER SETTINGS MAY BE REQUIRED FOR YOUR APPLICATION.

DRIVE PARAMETER SETTINGS

PARAMETER #	NAME	SETTING	VALUE
0-02	MOTOR SPEED UNIT	1	HZ
0-03	REGIONAL SETTINGS	1	NORTH AMERICA
1-03	TORQUE CHAR.	3	AUTO ENERGY OPTIM VT
5-02	TERMINAL 29 TYPE	1	OUTPUT
5-31	TERMINAL 29	5	RUNNING
14-20	RESET MODE	13	INFINITE AUTO REST

NOTES:

- * INDICATES COMPONENTS NOT SUPPLIED BY MANUFACTURER.
- REFER TO THE INSTALLATION AND OPERATION MANUAL FOR DRIVE FUNCTIONS AND PARAMETER SETTINGS.
- BRANCHCIRCUIT PROTECTION, INPUT POWER AND MOTOR WIRING MUST BE SELECTED IN ACCORDANCE WITH THE N.E.C., ANY APPLICATION LOCAL CODES AND THE LOAD CURRENT RATING.
- REPLACE JUMPER 'J1' WITH NORMALLY CLOSED SAFETY INTERLOCK CONTACT AS NECESSARY. CONTACT MUST BE RATED 1/6 HP @ 120VAC MINIMUM.
- PANEL MAY REQUIRE DERATING, CONSULT DRIVE MANUAL OR FACTORY FOR FOLLOWING CONDITIONS:
 - HIGHER SWITCHING FREQUENCY THAN DRIVE DEFAULT
 - HIGHER THAN PANEL LISTED AMBIENT TEMPERATURES
 - ELEVATION ABOVE 3300 FEET (1000 METERS)
 - LONG MOTOR LEAD LENGTHS

B			-NOTICE- THIS DRAWING IS PROPRIETARY AND SHALL NOT BE COPIED OR ITS CONTENTS DISCLOSED TO OUTSIDE PARTIES WITHOUT THE WRITTEN CONSENT OF THE TRANE COMPANY	DRN	NAME				THE TRANE COMPANY A DIVISION OF AMERICAN STANDARD INC.	
A	SP10119	11/10		APR	NEMA 3R,240V,NB ,MAIN DISC, DRIVE FUSE ,IR,CONTACT MOTOR SELECT,4 FAN					
DR	SP10076	09/10			MODEL	TR200	PAGE	1 OF 2	SIZE	A
REV	ECN	DATE							DWG NO.	185B4277

WIRE COLOR SCHEME
 BLACK - LINE VOLTAGE
 RED - AC CONTROL
 WHITE - AC GROUNDED
 CIRCUIT CONDUCTOR
 BLUE - DC CONTROL
 GREEN - CHASSIS GROUND

TERMINAL IDENTIFICATION

(X) - DRIVE TERMINAL
 (X) - CUSTOMER TERMINAL

CUSTOMER DRY CONTACT RATINGS

RELAY	CONTACT RATING
CR6	5A @ 120VAC 1/10 HP @ 120VAC
M4, M5	10A @ 120/240VAC



CONTACT SEQUENCE CHART FOR S2
 X INDICATES CONTACT CLOSED

POSITION CONTACT	MOTOR 1	AUTO	MOTOR 2
11-12	X	X	
13-14			X
21-22		X	X
23-24	X		

B		
A	SP10119	11/10
DR	SP10076	09/10
REV	ECN	DATE

-NOTICE-
 THIS DRAWING IS PROPRIETARY AND SHALL NOT BE COPIED OR ITS CONTENTS DISCLOSED TO OUTSIDE PARTIES WITHOUT THE WRITTEN CONSENT OF THE TRANE COMPANY

DRN DTM
 APR DTM

NAME NEMA 3R,240V,NB
 ,MAIN DISC, DRIVE FUSE
 ,IR,CONTACT MOTOR SELECT,4 FAN

THE TRANE COMPANY
 A DIVISION OF
 AMERICAN STANDARD INC.

MODEL TR200 PAGE 2 OF 2 SIZE A DWG NO. 185B4277