

ENGINEERING
TOMORROW

Danfoss

Engineering Guide | VLT® AQUA Drive FC 200

Facility **service**, design and
project engineering for **water**
and **wastewater plants**

4 steps

to a safe installation.
Danfoss supports
your planning with
our longstanding
experience.

www.danfoss.com/drives

VLT®
THE REAL DRIVE

The removable design checklist at the back of this manual leads you to optimal design results in four steps.



Contents

Design aids	6
Part 1: Basics.....	8
Reducing costs and increasing convenience	8
Speed control saves energy	9
Boosting cost effectiveness.....	10
Achieving potential savings in practice	11
Part 2: Four steps to an optimal system	12
Step 1: Practical aspects of AC mains systems	12
Recognising the actual mains configuration	
Practical aspects of electromagnetic compatibility (EMC)	13
<i>Electromagnetic effects work in both directions</i>	
<i>The responsibility rests with the operator</i>	
<i>Two possible means of reduction</i>	
Distinguishing between conducted and radiated interference.....	14
Coupling mechanisms between electrical circuits	
Conductive coupling	
Capacitive coupling	
Radiation coupling	
Practical aspects of mains power quality	15
Low-frequency mains interference	
Supply networks at risk	
Quality assured by statutory provisions	
How mains interference occurs	
Practical aspects of low- frequency mains interference	16
Effects of mains interference	
Undervoltage warnings	
Higher losses	
Are interference- free frequency converters available ?	
Analysing mains interference	
Practical aspects of mains interference reduction	17
Options for reducing mains interference	
Chokes at the input or in the DC link	
Rectifier with 12, 18 or 24 pulses per cycle	
Passive filters	
Advantages of passive filters	
Drawbacks of passive filters	
Active filters	18
Advantages of active filters	
Drawbacks of active filters	
Current and Distortion Spectrum at Full load	
Slim DC link	19
Active front end	
Advantages of AFE	20
Drawbacks of AFE	
Practical aspects of high-frequency interference (RFI)	21
Radio frequency interference	
Standards and directives define limits	
Practical aspects of 1st and 2nd environment	22
The operating site is the decisive factor	
Environment 1 (Class B): residential environment	
Environment 2 (Class A): industrial environment	
Special environments	
No compromises	
Practical aspects of mains protection measures.....	23
Power factor correction	
Mains transients	
Practical aspects of operation with a transformer or standby generator	24
Maximum transformer utilisation	
Transformer load	
Power quality	
Operation with a standby generator	

Contents

Step 2: Practical aspects of ambient and environmental conditions	25
The right installation location: <i>Cabinet mount versus wall mount</i>	
Practical aspects of IP ratings	26
IP rating scheme according to IEC 60529	
Practical aspects of cooling design	27
<i>Compliance with ambient temperature specifications</i>	
<i>Cooling</i>	
<i>Relative humidity</i>	
Practical aspects of special requirements	28
Aggressive atmosphere or gases	
Dust exposure	29
<i>Reduced cooling</i>	
<i>Cooling fans</i>	
<i>Filter mats</i>	
Practical aspects of potentially explosive atmospheres	30
Potentially explosive atmospheres	
Step 3: Practical aspects of motors and cabling	31
Minimum efficiency classes for motors	
<i>Mandatory minimum efficiencies</i>	
<i>IE and Eff classes: major differences in details</i>	
<i>Affected three-phase motors</i>	
Practical aspects of IE classification of motors	32
<i>Schedule for MEPS implementation</i>	
<i>Compliance with EN 50347 mounting dimension specifications</i>	
<i>Cost-effectiveness</i>	
Practical aspects of EC and PM motors	33
<i>Many names for the same technology</i>	
<i>The technology</i>	
<i>High efficiency</i>	
<i>The Danfoss EC+ concept</i>	
<i>Oversynchronous operation</i>	34
<i>Standard IEC enclosure</i>	
Practical aspects of motor suitability for frequency converter operation	35
<i>Selection criteria</i>	
<i>Insulation stress</i>	
<i>Bearing stress</i>	
<i>Thermal stress</i>	
Practical aspects of output filters	36
Sine-wave and du/dt filters	
<i>Functions and tasks of sine-wave filters</i>	
<i>When are sine-wave filters used?</i>	
<i>Retrofitting</i>	
Practical aspects of motor cables	37
<i>Rated voltage</i>	
<i>Cable dimensioning</i>	
<i>Motor cable length</i>	
<i>Energy savings</i>	
<i>Cables with suitable shielding</i>	
Practical aspects of earthing	38
The importance of earthing	
<i>Electrically conductive materials</i>	
<i>Star-configured earthing system</i>	
<i>Contact points</i>	
<i>Conductor surface area</i>	

Practical aspects of shielding	39
The importance of shielding	
<i>Shielded cables and wiring</i>	
<i>Shield connection</i>	
<i>Shield gaps</i>	
<i>Ground connection</i>	40
<i>Motor supply cable</i>	
<i>Signal cable</i>	
<i>Types of shields</i>	
Step 4: Practical aspects of frequency converter selection	41
<i>Basic design</i>	
<i>Constant or variable torque</i>	
Practical aspects of load curves for various applications	42
Characteristic curves and applications	
Practical aspects of multi-motor operation (special case)	43
<i>Design</i>	
<i>Cable routing</i>	
Practical aspects of EMC measures	44
Putting theory into practice	
Radio frequency interference	
<i>Practical recommendations</i>	
<i>Two approaches to RFI filters</i>	
Mains interference	45
<i>The DC link affects mains interference</i>	
<i>Reduction measures</i>	
<i>Mains chokes</i>	
<i>Rectifiers with 12, 18 or 24 pulses per cycle</i>	46
<i>Passive filters</i>	
<i>Active filters, active front ends and low harmonic drives</i>	
Practical aspects of residual current devices	47
AC/DC residual current protective devices	
<i>Leakage current level</i>	
Practical aspects of earthing and motor protection	48
Earthing measures in practice	
Motor protection and motor PTC thermistor	
Practical aspects of operator control and data display	49
Simple operating concept	
<i>Operation under local control</i>	50
<i>Clear display</i>	
<i>Uniform concept</i>	
<i>Integrated in the cabinet door</i>	
Practical aspects of control and parameter configuration with a PC	51
<i>Extended options</i>	
Practical aspects of data exchange	52
<i>Bus systems</i>	
<i>Better alarm management</i>	
<i>Better facility management</i>	
<i>Lower installation costs</i>	
<i>Simplified commissioning</i>	
Practical aspects of additional selection factors	53
Process controller	
Maintenance	
Storage	
VLT® AQUA Drive	54
Directives related to frequency converters	55
Index	56
Abbreviations	59
Design checklist	60
Notes	62

Design aids for high-level and detailed design

Engineering Guide for Water and Wastewater

The Danfoss Engineering Guide for Water and Wastewater is aimed at engineering firms, public authorities, associations, plant engineers and electrical engineers actively involved in water and wastewater technology. It is conceived as a comprehensive aid for facility services designers (ICA and electrical) and project engineers whose scope of responsibility includes the project engineering of variable-speed systems using frequency converters.

For this purpose, our specialists have coordinated the contents of this design manual with facility services designers in the industry in order to provide answers to important questions and achieve the greatest possible benefits for property

owners/developers and/or contracting authorities. The descriptions in the individual sections are intentionally concise. They are not intended to serve as extensive explanations of technical matters, but instead to point out the relevant issues and specific requirements for project engineering. In this way, the Engineering Guide for Water and Wastewater provides assistance in the project engineering of frequency-controlled drives and in the assessment of the products of various manufacturers of frequency converters.

Project engineering of variable-speed drives often gives rise to questions that are not directly related to the actual tasks of a frequency converter. Instead, they relate to the integration

of these devices into the drive system and the overall facility. For this reason, it is essential to consider not only the frequency converter, but also the entire drive system. This system consists of a motor, a frequency converter, cabling, and the general conditions of the ambient situation, which includes the AC mains supply and the environmental conditions.

Project engineering and layout of variable-speed drive systems are of decisive importance. The decisions made by the facility services designer or project engineer at this stage are crucial with regard to the quality of the drive system, operating and maintenance costs, and reliable, trouble-free operation. Well-conceived project engineering before-

Anyone involved in the project engineering of frequency converters should give careful consideration to the general technical conditions of these devices.



hand helps avoiding undesirable side effects during subsequent operation of the drive system.

This engineering guide and included design checklist are ideal tools for achieving the best possible design reliability and thereby contributing to the operational reliability of the overall system.

The Engineering Guide for Water and Wastewater is divided into two parts. The first part provides background information on the use of frequency converters in general. This includes the topics of energy efficiency, reduced life cycle costs and longer service life. The second part of this design manual guides you through the four essential steps in the design and project

engineering of a system and provides tips on retrofitting speed control capability in existing systems. It addresses the factors you must pay attention to in order to achieve reliable system operation – the selection and dimensioning of the mains power supply, the ambient and environmental conditions, the motor and its cabling and the selection and dimensioning of the frequency converter – and gives you all the information you need regarding these aspects.

There is also a checklist at the back of the manual, which you can use to tick off the individual steps. If you take all of these factors into account, you can achieve an optimal system design that provides reliable operation at all times.



Part 1: Basics

Reducing costs and increasing convenience

Compared with mechanical speed control systems, electronic speed control can save a lot of energy and substantially reduce wear. Both of these factors significantly reduce operating costs. The more often drive systems are operated (or must operate) under partial load, the higher the potential savings in terms of energy and maintenance costs. Due to the high potential for energy savings, the extra cost of an electronic speed control system can be recovered within a few months. In addition, modern systems have an extremely positive effect on many aspects of system processes and overall system availability.

High energy saving potential

With an electronic speed control system, the flow, pressure or differential pressure can be matched to the actual demand. In practice, systems operate predominantly under partial load rather than full load. In case of fans, pumps or compressors with variable torque characteristics, the extent of the energy savings depends on the difference between partial-load and full-load operation. The larger this is, the less time is required to recover the investment. It is typically around 12 months.

Start-up current limiting

Switching on equipment connected directly to the AC mains generates peak currents that can be up to six to eight times greater than the rated current. Frequency converters limit the start-up current to the rated motor current. In this way they eliminate switch-on current peaks and avoid voltage sags due to transient heavy loading of the supply network. Eliminating these current peaks reduces the connected load of the pump system as seen by the electricity supplier, which reduces provision costs and eliminates the need for supplementary E_{max} controllers.

Reduced system wear

Frequency converters start and stop motors gently and smoothly. Unlike motors operated directly from the AC mains, motors driven by frequency converters do not cause torque or load shocks. This reduces the stress on the entire drive train (motor, gearbox, clutch, pump/fan/compressor) and piping system, including the seals. In this way, speed control significantly reduces wear and prolongs the lifetime of the system. Maintenance and repair costs are lower thanks to longer operating periods and lower material wear.

Optimal operating point adjustment

The efficiency of water and wastewater handling systems depends on the optimal operating point. This point varies depending on system capacity utilisation. The system works more efficiently when it runs closer to the optimal operating point. Thanks to their continuously variable speed, frequency converters can drive the system at exactly the optimal operating point.

Extended control range

Frequency converters allow motors to be operated in the „oversynchronous“ range (output frequency above 50 Hz). This allows the output power to be boosted briefly. The extent to which oversynchronous operation is possible depends on the maximum output current and overload capacity of the frequency converter. In practice, pumps are often operated at a frequency of 87 Hz. The motor manufacturer must always be consulted regarding motor suitability for oversynchronous operation.

Lower noise generation

Systems running under partial load are quieter. Speed-controlled operation significantly reduces acoustic noise generation.

Increased lifetime

Drive systems operating under partial load suffer less wear, which translates into longer service life. The reduced, optimised pressure also has a beneficial effect on the piping.

Retrofitting

Frequency converters can usually be retrofitted in existing drive systems with little effort.



Speed control saves energy

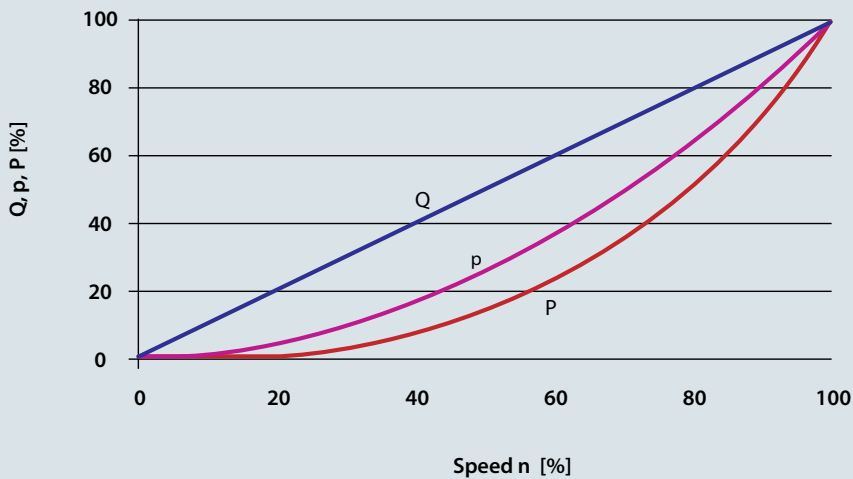

Proportionality rules of fluid flow machines. Due to the physical relationships, the throughput Q , pressure p and power P are directly dependent on the machine speed with fluid flow machines.

The energy saving potential when a frequency converter is used depends on the type of load being driven and the optimisation of the efficiency of the pump or the drive by the frequency converter, as well as how much time the system operates under partial load. Domestic water and wastewater systems are designed for rarely-occurring peak loads, so they are usually operated under partial load.

Centrifugal pumps and fans offer the largest potential for energy savings. They fall in the class of fluid flow machines with variable torque curves, which are subject to the following proportionality rules.

The flow increases linearly with increasing speed (rpm), while the pressure increases quadratically and the power consumption increases cubically.

The decisive factor for energy savings is the cubic relationship between rpm and power consumption. A pump running at half its rated speed, for

example, needs only one-eighth of the power necessary for operation at its rated speed. Even small reductions in speed thus lead to significant energy savings. For example, a 20% speed reduction yields 50% energy savings. The main benefit of using a frequency converter is that speed control does not waste power (unlike regulation with a throttle valve or damper, for example), but instead adjusts the motor power to match exactly the actual demand.

Additional energy savings can be achieved by optimising the efficiency of the pump or drive with frequency converter operation. The voltage control characteristic (V/f curve) supplies the right voltage to the motor for every frequency (and thus motor speed). In this way, the controller avoids motor losses resulting from excessive reactive current.

Remark: Danfoss VLT® AQUA Drive frequency converters optimise energy demand even further. The Automatic Energy Optimisation (AEO) function constantly adjusts the current motor voltage so the motor runs with the highest possible efficiency. In this way, the VLT® AQUA Drive always adapts the voltage to the actual load conditions it measures. The additional energy saving potential amounts to an extra 3 to 5%.



Boosting cost effectiveness

Life cycle cost (LCC) analysis

Until a few years ago, plant engineers and operators only considered procurement and installation costs when selecting a pump system. Today a full analysis of all costs is becoming increasingly common. Under the name "life cycle cost" (LCC), this form of analysis includes all costs incurred by pump systems during their operational life.

A life cycle cost analysis includes not only the procurement and installation costs, but also the costs of energy, operation, maintenance, downtime, the environment, and disposal. Two factors – energy cost and maintenance cost – have a decisive effect on the life cycle cost. Operators look for innovative controlled pump drives in order to reduce these costs.

Reducing energy costs

One of the largest cost factors in the life cycle cost formula is the energy cost. This is especially true when pump systems run more than 2000 hours per year.

$$LCC = C_{ic} + C_{in} + C_e + C_o + C_m + C_s + C_{env} + C_d$$

C_{ic} = initial capital cost (procurement cost)

C_{in} = installation and commissioning costs

C_e = energy cost

C_s = downtime and lost production costs

C_o = operating cost

C_{env} = environmental cost

C_m = maintenance cost

C_d = decommissioning and disposal costs

Life cycle cost calculation

Most existing pump systems have substantial dormant energy saving potential. This arises from the fact that most pump drives are overdimensioned because they are designed for worst-case conditions. The volumetric flow is often regulated by a throttle valve. With this form of regulation, the pump always runs at full capacity and thus consumes energy unnecessarily.

This is comparable to driving a car with the engine always running at full throttle and using the brakes to adjust the speed.

Modern, intelligent frequency converters offer ideal means to reduce energy consumption as well as maintenance costs.

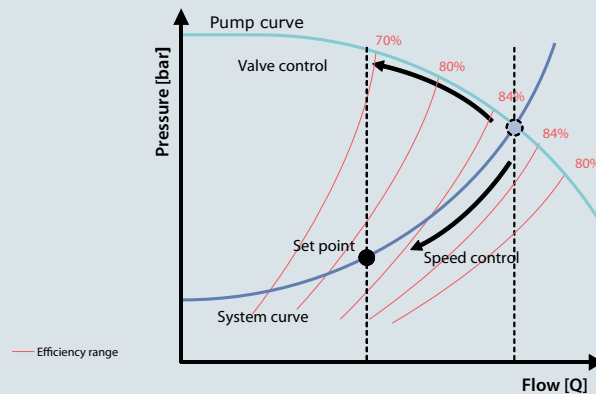
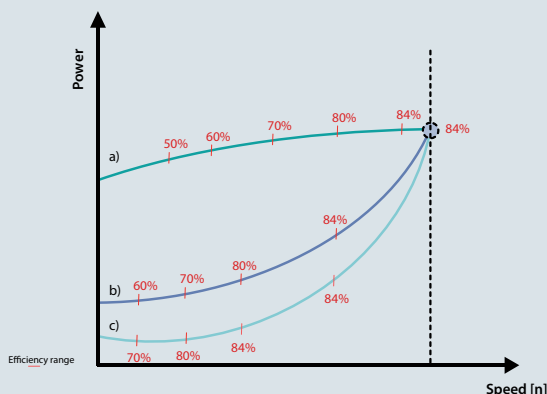

- a) Valve control: η decreases
- b) Actual speed control: η curve not aligned to system curve
- c) Optimal speed control: η curve nearly matches system curve

In addition to the pump and system characteristic curves, this plot shows several efficiency levels. Both valve control and speed control cause the operating point to move out of the optimum efficiency range.

Achieving potential savings in practice

The descriptions in the first part of this design manual focus primarily on the fundamentals and potential savings in water and wastewater technology.

Among other things, they deal with life cycle costs, reducing energy consumption and reducing energy costs and reducing service and maintenance costs. Your task now is to carry out considered, intelligent design in order to achieve these potential benefits in reality.

To this end, the second part of this manual guides you through the design process in four steps.

The following sections:

- Mains systems
- Ambient and environmental conditions
- Motors and cables
- Frequency converters give you all the information about characteristics and data that you need for component selection and dimensioning in order to ensure reliable system operation.

In places where more detailed knowledge is advantageous, we provide references to additional documents in addition to the basic information in this manual.

The checklist included at the end of this manual, which you can fold out or tear out, is also a handy aid where you can tick off the individual steps. This gives you a quick and easy overview of all relevant design factors.

By taking all these factors into account, you put yourself in an ideal position to design a reliable and energy-efficient system.



Part 2: Four steps to an optimal system

Step 1: Practical aspects of AC mains systems

Recognising the actual mains configuration

Various types of AC mains systems are used to supply power to electrical drives. They all affect the EMC characteristics of the system to various degrees. The five-wire TN-S system is the best in this regard, while the isolated IT system is the least desirable.

TN mains systems

There are two versions of this form of mains distribution system: TN-S and TN-C.

TN-S

This is a five-wire system with separate neutral (N) and protective earth (PE) conductors. It thus provides the best EMC properties and avoids the transmission of interference.

TN-C

This is a four-wire system with a common neutral and protective earth conductor throughout the entire system. Due to the combined neutral and protective earth conductor, a TN-C system does not have good EMC characteristics.

TT mains systems

This is a four-wire system with an earthed neutral conductor and individual earthing of the drive units. This system has good EMC characteristics if the earthing is implemented properly.

IT mains system

This is an isolated four-wire system with the neutral conductor either not earthed or earthed via an impedance.

Note: All EMC features of the frequency converter (filters, etc.) must be disabled when it is used in an IT mains system.

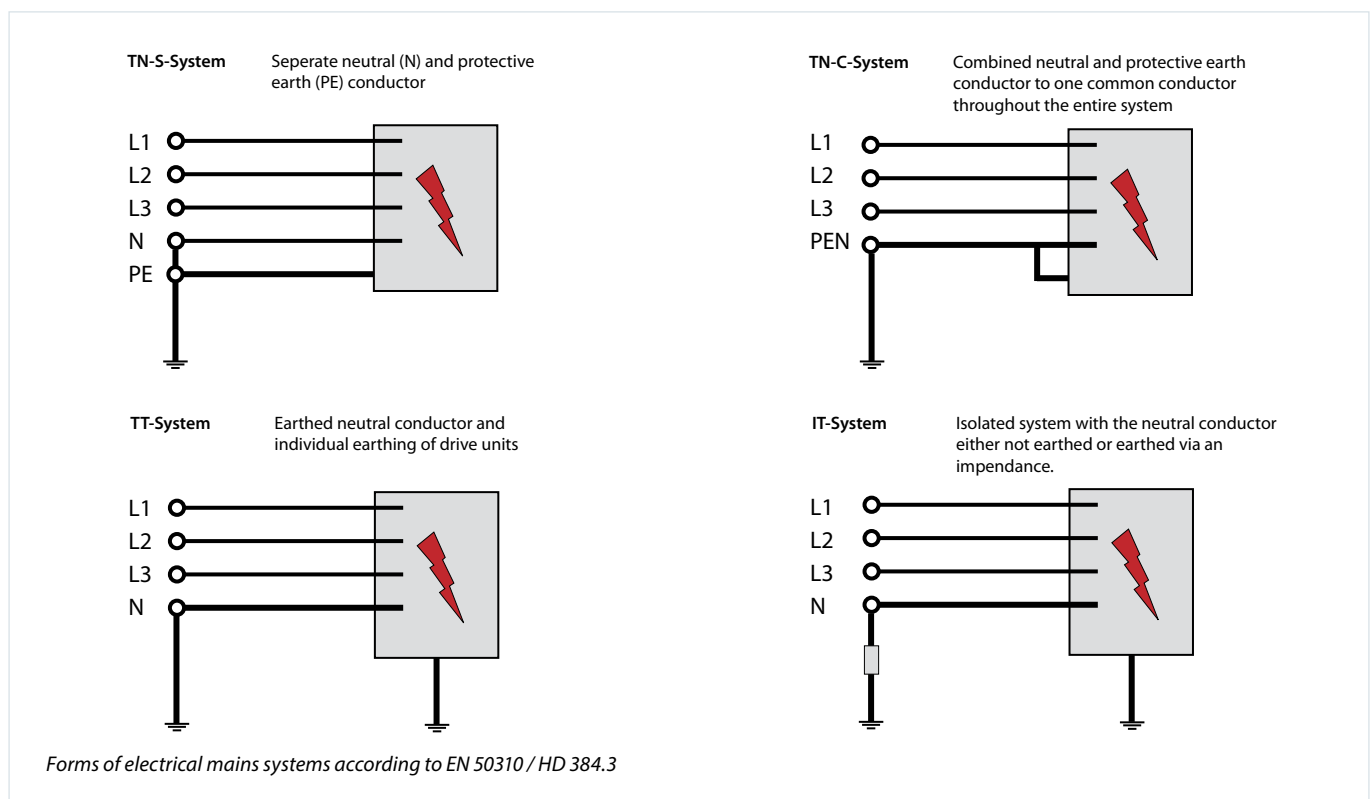

Practical aspects of electromagnetic compatibility (EMC)

Every electrical device generates electrical and magnetic fields that affect its direct environment to a certain extent.

The magnitude and consequences of these effects depend on the power and the design of the device. In electrical machinery and systems, interactions between electrical or electronic assemblies may impair or prevent reliable, trouble-free operation. It is therefore important for operators, designers and plant engineers to understand the mechanisms of these interactions. Only then will they be able to take appropriate, cost-effective countermeasures at the design stage.

This is because the cost of suitable measures increases with each stage of the process.

Electromagnetic effects work in both directions

System components affect each other: every device generates interference and is affected by interference. In addition to the type and amount of interference an assembly generates, it is characterised by its immunity to interference from nearby assemblies.

The responsibility rests with the operator

Previously, the manufacturer of a component or assembly for electrical drives had to take countermeasures to comply with statutory standards. With the introduction of the EN 61800-3 standard for variable-speed drive systems, this responsibility has been transferred to the end user or operator of the system. Now manufacturers only have to offer solutions for operation

conforming to the standard. Remedying any interference that may occur (in other words, using these solutions), along with the resulting costs, is the responsibility of the operator.

Two possible means of reduction

Users and plant engineers have two options for ensuring electromagnetic compatibility. One option is to stop interference at the source by minimising or eliminating the emitted interference. The other option is to increase the interference immunity of the device or system affected by interference by preventing or substantially reducing the reception of interference.

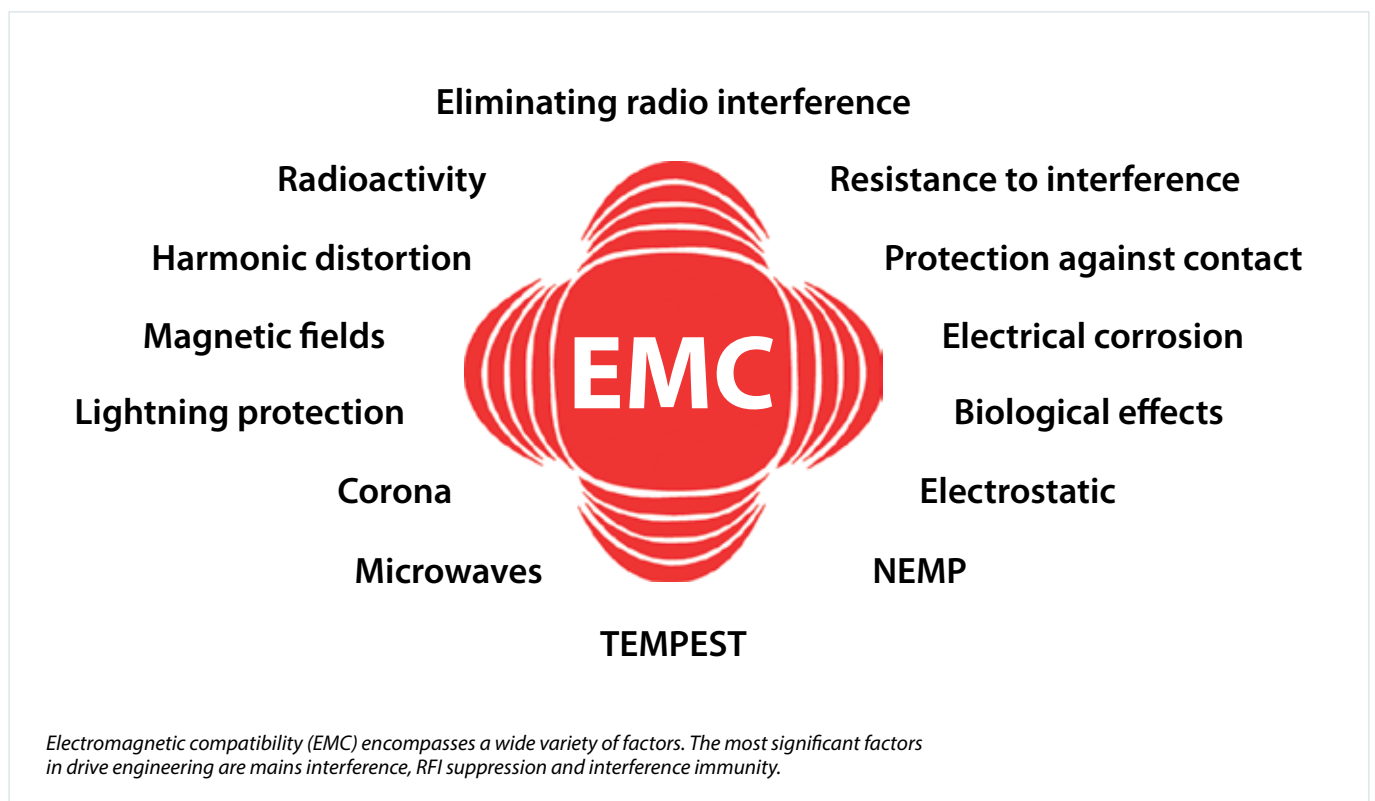

Practical aspects of electromagnetic compatibility (EMC)

Distinguishing between conducted and radiated interference

There are always interactions when several systems are present. Experts distinguish between the interference source and the interference sink, which in practice usually means the device causing the interference and the device affected by it. All types of electrical and magnetic quantities can potentially cause interference. For example, interference may take the form of mains harmonics, electrostatic discharges, rapid voltage fluctuations, high-frequency interference or interference fields. In practice, mains harmonics are often referred to as mains interference, harmonic over-tones or simply harmonics.

Coupling mechanisms between electrical circuits

Now you're probably wondering how interference is transmitted. As a form of electromagnetic emission, it can essentially be transmitted by conductors, electric fields, or electromagnetic waves. In technical terms, these are called conductive, capacitive and/or inductive coupling, and radiation coupling, which means an interaction between different circuits in which electromagnetic energy flows from one circuit to another one.

Conductive coupling

Conductive coupling occurs when two or more electrical circuits are connected to one another by a common conductor, such as a potential equalisation cable.

Capacitive coupling

Capacitive coupling results from voltage differences between the circuits. Inductive coupling occurs between two current-carrying conductors.

Radiation coupling

Radiation coupling occurs when an interference sink is located in the far-field region of an electromagnetic field generated by an interference source. For the purpose of electromagnetic analysis, the standard specifies 30 MHz as the boundary between conductive coupling and radiation

coupling. This corresponds to a wavelength of 10 metres. Below this frequency, electromagnetic interference is mainly propagated through conductors or coupled by electrical or magnetic fields. Above 30 MHz, wires and cables act as aerials and emit electromagnetic waves.

Interference diffusion paths

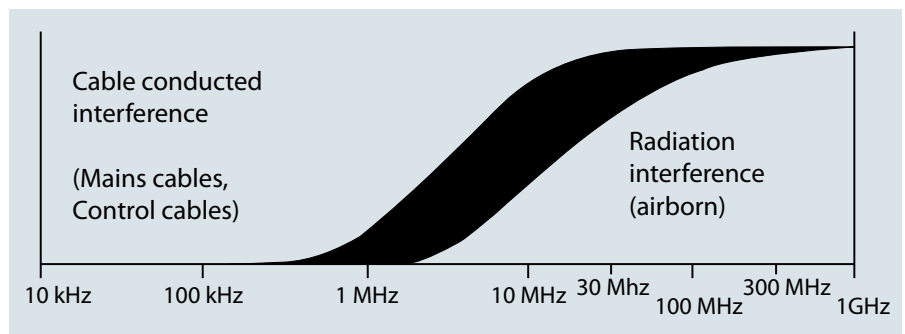

Electromagnetic interference occurs over the entire frequency range, but the propagation paths and form of diffusion vary.

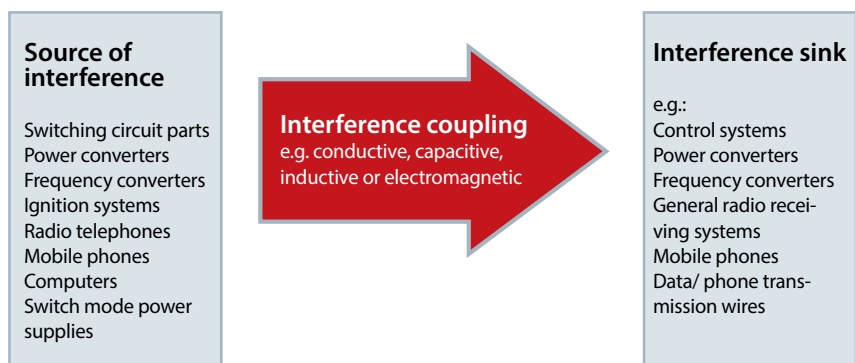

Overview of coupling paths for electromagnetic interference and typical examples

Frequency converters and EMC

Low-frequency effects (conductive) → Mains interference/harmonics
 High-frequency effects (radiation) → Radio frequency interference (emission of electromagnetic fields)

Practical aspects of mains power quality

Low-frequency mains interference

Supply networks at risk

The mains voltage supplied by electricity companies to homes, businesses and industry should be a uniform sinusoidal voltage with constant amplitude and frequency. This ideal situation is no longer found in public power grids. This is due in part to loads that draw non-sinusoidal currents from the mains or have non-linear characteristics, such as PCs, television sets, switching power supplies, energy-efficient lamps, and frequency converters. Mains power quality will decline even more in the future due to the European energy network, higher grid utilisation and reduced investments. Deviations from the ideal sinusoidal waveform are therefore unavoidable and permissible within certain limits.

Facility services designers and operators have an obligation to keep mains interference to a minimum. But what are the limits and who specifies them?

How mains interference occurs

Specialists refer to the distortion of the sinusoidal waveform in mains systems caused by the pulsating input currents of the connected loads as "mains interference" or "harmonics". They also call this the harmonic content on the mains, which is derived from Fourier analysis, and they assess it up to 2.5 kHz, corresponding to the 50th harmonic of the mains frequency.

Quality assured by statutory provisions

Standards, directives and regulations are helpful in any discussion regarding clean, high-quality mains power. In most of Europe the basis for the objective assessment of the quality of mains power is the Electromagnetic Compatibility of Devices Act. European standards EN 61000-2-2, EN 61000-2-4 and EN 50160 define the mains voltage limits that must be observed in public and industrial power grids.

The EN 61000-3-2 and 61000-3-12 standards are the regulations concerning mains interference generated by connected devices. Facility operators must also take the EN 50178 standard and the connection conditions of the electricity company into account in the overall analysis. The basic assumption is that compliance with these levels ensures that all devices and systems connected to electrical distribution systems will fulfil their intended purpose without problems.

The input rectifiers of frequency converters generate this typical form of harmonic interference on the mains. Where frequency converters are connected to 50-Hz mains systems, the third harmonic (150 Hz), fifth harmonic (250 Hz) or seventh harmonic (350 Hz) are considered. This is where the effects are the strongest. The total harmonic content is also called the total harmonic distortion (THD).

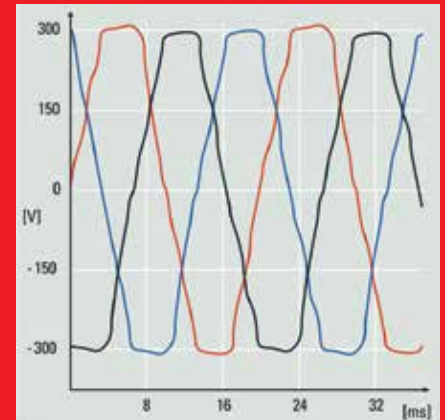

Measurements show distinct distortion of the mains voltage waveform due to interference from nonlinear loads.

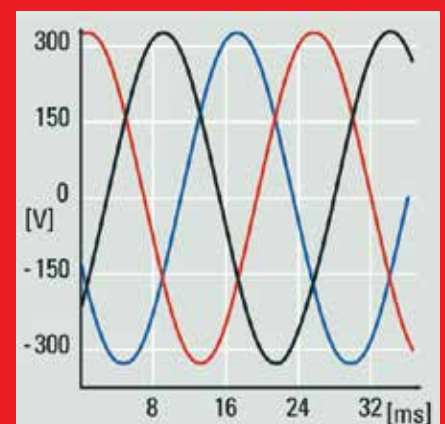

The ideal situation of a sinusoidal mains voltage is rarely found nowadays in our mains grids.

Practical aspects of low-frequency mains interference

Analysing mains interference

To avoid excessive impairment of mains power quality, a variety of reduction, avoidance and compensation methods can be used with systems or devices that generate harmonic currents. Mains analysis programs, such as VLT® MCT 31 Harmonic Calculation software, can be used for system analysis as early as the design stage. In this way, operators can consider and test specific countermeasures beforehand and ensure subsequent system availability.

Remark: Danfoss has a very high level of EMC expertise and many years of experience in this area. We convey this experience to our customers by means of training courses, seminars, workshops and in everyday practice in the form of EMC analyses with detailed evaluation or mains calculations.

Note: Excessive harmonic content puts a load on power factor correction equipment and may even cause its destruction. For this reason, they should be fitted with chokes.



VLT® MCT 31 estimates the harmonic current and voltage distortion of your application and determines if harmonic filtering is needed. In addition the software can calculate the effect of adding mitigation equipment and if your system complies with various standards.

Effects of mains interference

Harmonics and voltage fluctuations are two forms of low-frequency conducted mains interference. They have a different appearance at their origin than at any other point in the mains system where a load is connected.

Consequently, the mains feed, mains structure and loads must all be taken into account collectively when assessing mains interference. The effects of an elevated harmonic level are described below.

Undervoltage warnings

- Incorrect voltage measurements due to distortion of the sinusoidal mains voltage.
- Reduced mains power capacity

Higher losses

- Harmonics take an additional share of the active power, apparent power and reactive power
- Shorter lifetime of devices and components, for example as a result of additional heating effects due to resonances.

- Malfunction or damage to electrical or electronic loads (such as a humming sound in other devices). In the worst case, even destruction.
- Incorrect measurements because only true-RMS instruments and measuring systems take harmonic content into account.

Are interference-free frequency converters available?

Every frequency converter generates mains interference. However, the present standard only considers the frequency range up to 2 kHz. For this reason, some manufacturers shift the mains interference into the region above 2 kHz, which is not addressed by the standard, and advertise them as „interference-free“ devices. Limits for this region are currently being studied.

Practical aspects of mains interference reduction

Options for reducing mains interference

Generally speaking, mains interference from electronic power controllers can be reduced by limiting the amplitude of pulsed currents. This improves the power factor λ (lambda). To avoid excessive impairment of mains power quality, a variety of reduction, avoidance or compensation methods can be used with systems and devices that generate harmonics.

- Chokes at the input or in the DC link of frequency converters
- Slim DC links
- Rectifiers with 12, 18 or 24 pulses per cycle
- Passive filters
- Active filters
- Active front end and VLT® Low Harmonic Drives

Chokes at the input or in the DC link

Even simple chokes can effectively reduce the level of harmonics fed back into the mains system by rectifier circuits as mains interference. Frequency converter manufacturers usually offer them as supplementary options or retrofits.

The chokes can be connected ahead of the frequency converter (on the feed side) or in the DC link after the rectifier. As the inductance has the same effect in either location, the attenuation of the mains interference is independent of where the choke is installed.

Each option has advantages and drawbacks. Input chokes are more expensive, larger, and generate higher losses than DC chokes. Their advantage is that they also protect the rectifier against mains transients. DC chokes are located in the DC link. They are more effective, but they usually cannot be retrofitted. With these chokes, the total harmonic distortion from a B6 rectifier can be reduced from a THD of 80% without chokes to

approximately 40%. Chokes with a U_k of 4% have proven to be effective for use in frequency converters. Further reduction can only be achieved with specially adapted filters.

Rectifier with 12, 18 or 24 pulses per cycle

Rectifier circuits with a high number of pulses per cycle (12, 18 or 24) generate lower harmonic levels. They have often been used in high-power applications in the past.

However, they must be fed from special transformers with multiple phase-offset secondary windings that provide all the necessary power to the rectifier stage. In addition to the complexity and size of the special transformer, the disadvantages of this technology include higher investment costs for the transformer and the frequency converter.

Passive filters

Where there are especially stringent harmonic distortion limit requirements, passive mains interference filters are available as options. They consist of passive components, such as coils and capacitors.

Series LC circuits specifically tuned to the individual harmonic frequencies and connected in parallel with the load reduce the total harmonic distortion (THD) at the mains input to 10% or 5%. Filter modules can be

used with individual frequency converters or groups of frequency converters. To obtain the best possible results with a harmonic filter, it must be matched to the input current actually drawn by the frequency converter.

In terms of circuit design, passive harmonic filters are installed ahead of a frequency converter or a group of frequency converters.

Advantages of passive filters

This type of filter offers a good price/performance ratio. At relatively low cost, the operator can obtain a reduction in harmonic levels comparable to what is possible with 12- or 18-pulse/cycle rectifiers. The total harmonic distortion (THD) can be reduced to 5%.

Passive filters do not generate interference in the frequency range above 2 kHz. As they consist entirely of passive components, there is no wear and they are immune to electrical interference and mechanical stress.

Drawbacks of passive filters

Due to their design, passive filters are relatively large and heavy. Filters of this type are very effective in the load range of 80–100%. However, the capacitive reactive power increases with decreasing load and it is recommended that you disconnect the filter capacitors in no-load operation.

Remark: Danfoss VLT frequency converters are equipped with DC link chokes as standard. They reduce the mains interference to a THDi of 40%.



Practical aspects of mains interference reduction

Active filters

When requirements with regard to mains interference are even more stringent, active electronic filters are used. Active filters are electronic absorption circuits that the user connects in parallel with the harmonic generators. They analyse the harmonic current generated by the nonlinear load and supply an offsetting compensation current. This current fully neutralises the corresponding harmonic current at the connection point.

The degree of compensation is adjustable. In this way harmonics can be almost completely compensated if so desired, or (perhaps for economic reasons) only to the extent necessary to enable the system to comply with statutory limits. Here again it must be borne in mind that these filters operate with clock frequencies and produce mains interference in the 4–18 kHz range.

Advantages of active filters

Operators can incorporate active filters at any desired location in the mains system as central measures, depending on whether they wish to compensate individual drives, entire groups, or even an entire distribution system. It is not necessary to provide a separate filter for each frequency converter. The total harmonic distortion drops to a THD level $\leq 4\%$.

Drawbacks of active filters

One drawback is the relatively high investment cost. In addition, these filters are not effective above the 25th harmonic level. The effects above 2 kHz generated by the filters themselves must also be taken into account with active filter technology. They may require further measures to keep the mains system clean.

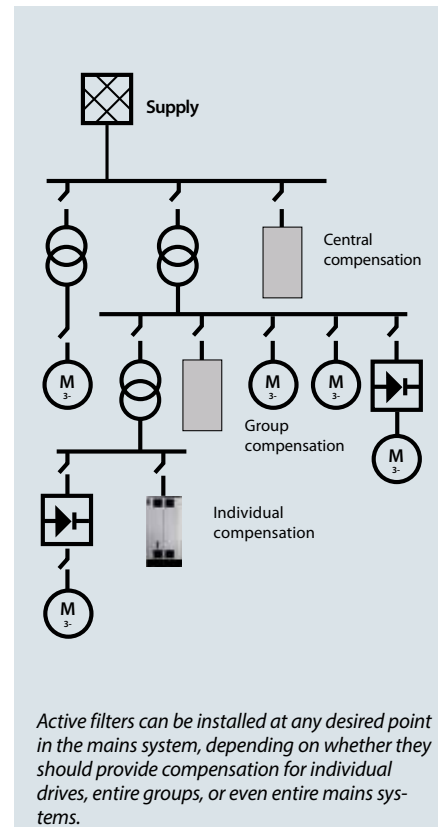

Active filters can be installed at any desired point in the mains system, depending on whether they should provide compensation for individual drives, entire groups, or even entire mains systems.

Current and Distortion Spectrum at Full Load

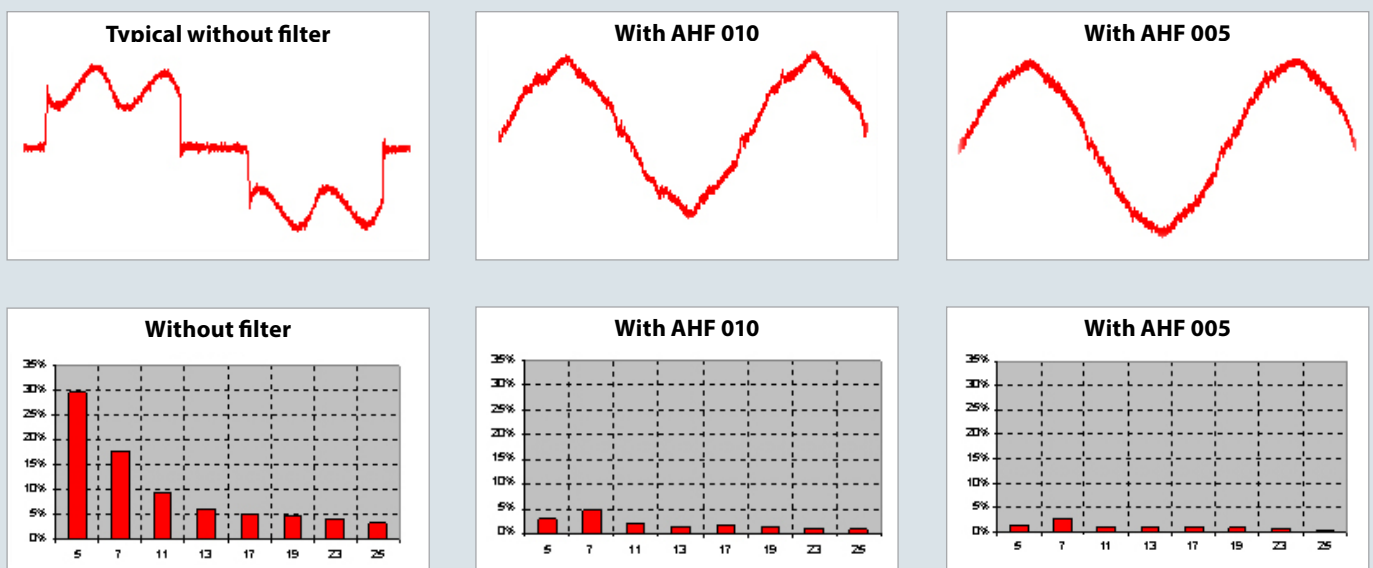

Advanced Harmonic Filters (AHF) reduce the total harmonic current distortion to 5% or 10% at 100% load.

Slim DC link

Recent years have seen the increasing availability of frequency converters with a “slim” DC link. In this approach, manufacturers greatly reduce the capacitance of the DC link capacitors. Even without a choke, this reduces the fifth harmonic of the current to a THD level below 40%.

However, it causes mains interference in the high frequency range that would otherwise not occur.

Due to the broad frequency spectrum of devices with slim DC links, there is a greater risk of resonances with other components connected to the mains, such as fluorescent lamps or transformers. Devising suitable measures is correspondingly time-consuming and very difficult.

In addition, converters with slim DC links have weaknesses on the load side. With converters of this sort, load variations result in significantly larger voltage variations. As a result, they have a greater tendency to oscillate in response to load variations on the motor shaft. Load shedding is also difficult. During load shedding the motor acts as a generator with high peak voltages. In response to this, devices with lean DC links shut down faster than conventional devices in order to protect against destruction due to overload or overvoltage.

Due to the small or zero capacitance, converters with slim DC links are not good at riding through mains drop-outs. As a rule of thumb, a slim DC link has around 10% of the capacitance of a conventional DC link.

In addition to mains interference due to the input current, converters with slim DC links pollute the mains with the switching frequency of the motor-side inverter. This is clearly visible on the mains side due to the low or zero capacitance of the DC link.

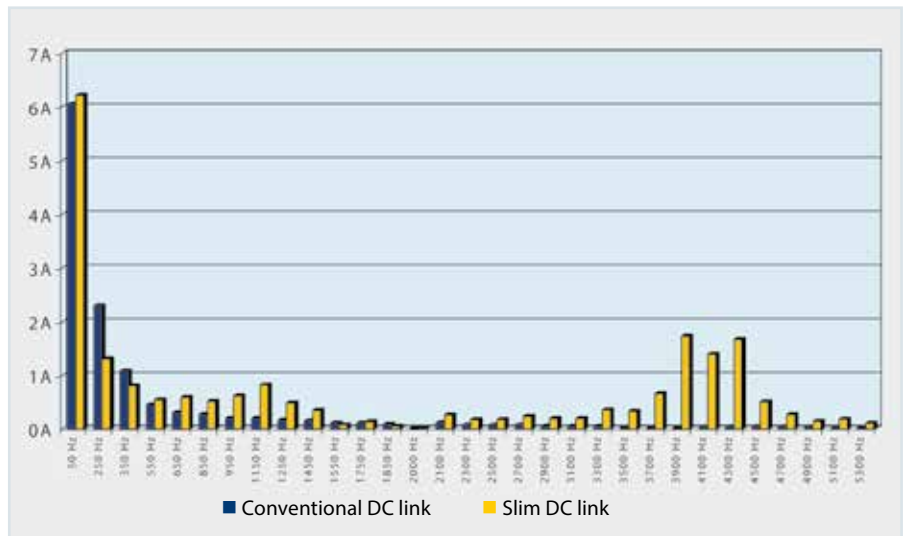

Converters with slim DC links generate higher harmonic levels, especially in the higher frequency ranges.

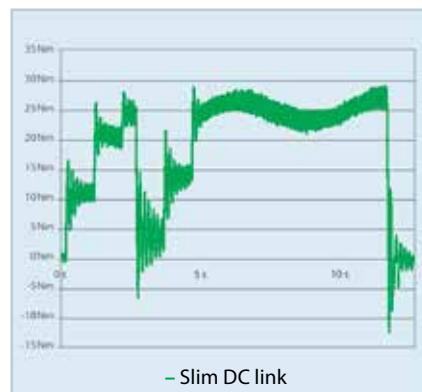

effective in attenuating low-frequency mains interference. Like frequency converters with slim DC links, they generate mains interference in the high frequency range.

An active front end is the most expensive approach to reducing mains interference, since it amounts to a supplementary, full-fledged frequency converter that is able to feed power back into the mains system. The low harmonic drive option does not offer this capability and is accordingly somewhat less costly.

Active Front End

‘Low Harmonic Drives’ (LHD) is often used when describing Active Front End (AFE) drives. However, this is a bit misleading as Low Harmonic Drives might cover many different technologies and include both passive and active mitigation. Active Front End drives have IGBT switches on the drive input circuits that replaces conventional rectifiers. These circuits use semiconductor devices with fast switching characteristics to force the input current to be approximately sinusoidal and they are very

Practical aspects of mains interference reduction

Advantages of AFE

The total harmonic distortion drops to a THD level of <4% in the range of the 3rd to the 50th harmonics. Four-quadrant operation is possible with AFE devices, which means that the braking power of the motor can be fed back into the mains system.

Drawbacks of AFE

The technical complexity of the devices is very high, which leads to very high investment costs. In principle, AFE devices consist of two frequency converters, with one supplying power to the motor and the other to the mains system. Due to the increased circuit complexity, the efficiency of the frequency converter is lower in motor operation. The power loss may be 40 to 50% higher than that of frequency converters with uncontrolled rectifiers.

An AFE always needs a higher DC link voltage for proper operation. In many cases this higher voltage is passed on to the motor, resulting in higher stress on the motor insulation. If the DC links of the AFE devices are not separated, filter failure results in failure of the entire device.

Another drawback is the clock frequency used by the devices for input current correction. It lies in the range of 3 to 6 kHz.

Good (and relatively complex) devices filter out this clock frequency before feeding power into the mains system. The currently applicable standards and statutes do not cover this frequency range. Currently available mains analysers usually do not acquire data in this frequency range and thus do not allow the effects to be measured.

However, they can be seen in all devices operating on the affected mains system, such as in the form of increased input current with power supplies. The effects will only become noticeable in later years.

Consequently, operators should specifically ask manufacturers about emission levels and countermeasures in the interest of the operational reliability of their own systems.

Note: There is nothing that specifies that series production devices must conform to the limits defined in EN 61000-3-12. It is entirely possible for a converter to conform to these limits only in combination with a supplementary filter.

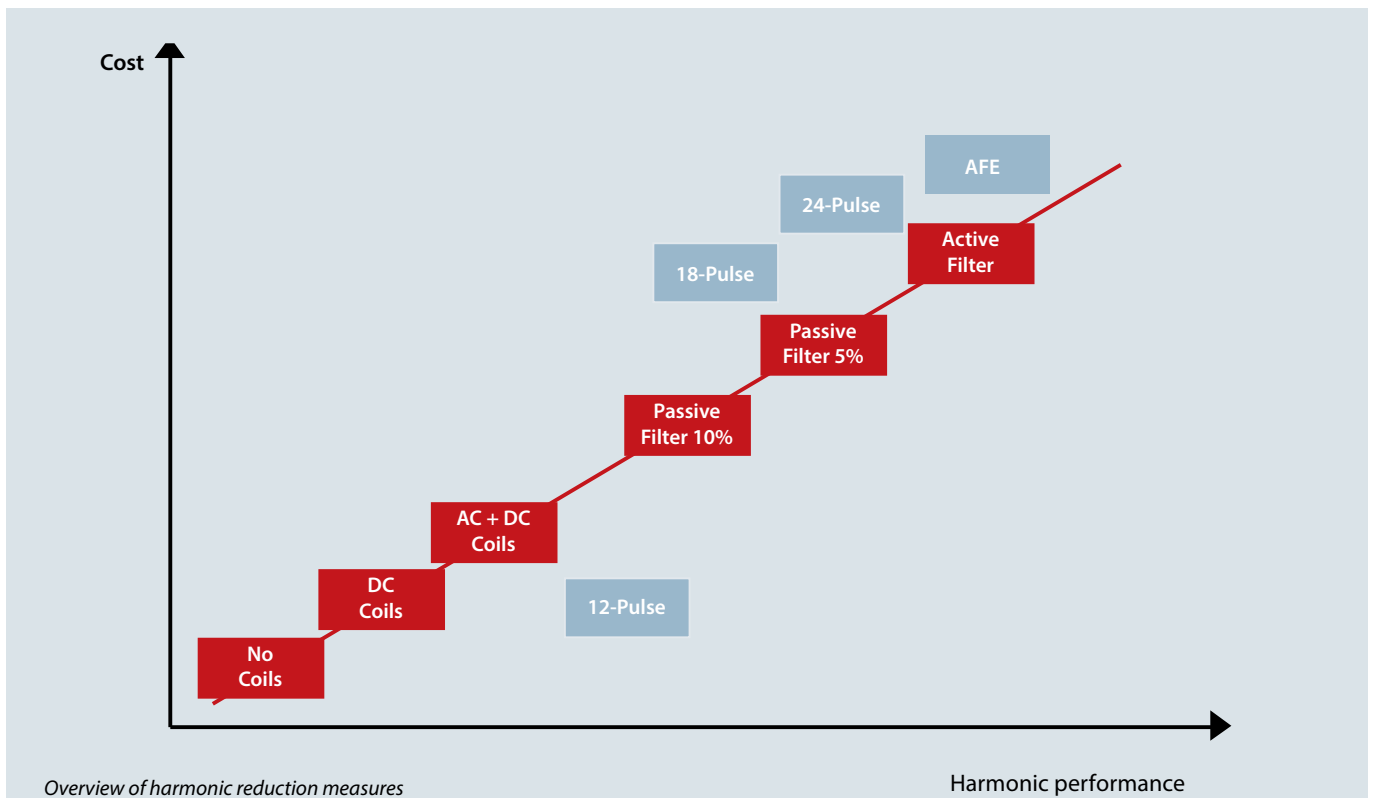

Practical aspects of high-frequency interference (RFI)

Radio frequency interference

Frequency converters generate variable rotating field frequencies at corresponding motor voltages due to variable-width rectangular current pulses. The steep pulse edges contain high-frequency components. Motor cables and frequency converters radiate these components and conduct them into the mains system via the cable.

Manufacturers use radio frequency interference (RFI) filters (also called mains filters or EMC filters) to reduce the level of this type of interference on the mains feed.

They serve to protect devices against high-frequency conducted interference (noise immunity) and to reduce the amount of high-frequency interference emitted by a device over

the mains cable or by radiation from the mains cable.

The filters are intended to limit these interference emissions to a specified statutory level, which means that as much as possible they should be fitted in the equipment as standard. As with mains chokes, with RFI filters the quality of the filter to be used must be clearly defined.

Specific limits for interference levels are defined in the EN 61800-3 product standard and the EN 55011 generic standard.

Standards and directives define limits

Two standards must be observed for the comprehensive assessment of radio frequency interference. The first is the EN 55011 environment standard, which defines the limits according to the basic environment: either industrial (classes A1 and A2) or residential (class B). In addition, the EN-61800-3 product standard for electrical drive systems, which came into effect in June 2007, defines new categories (C1 to C4) for device application areas.

Although they are comparable to the previous classes in terms of limits, they allow a wider range of application within the scope of the product standard.

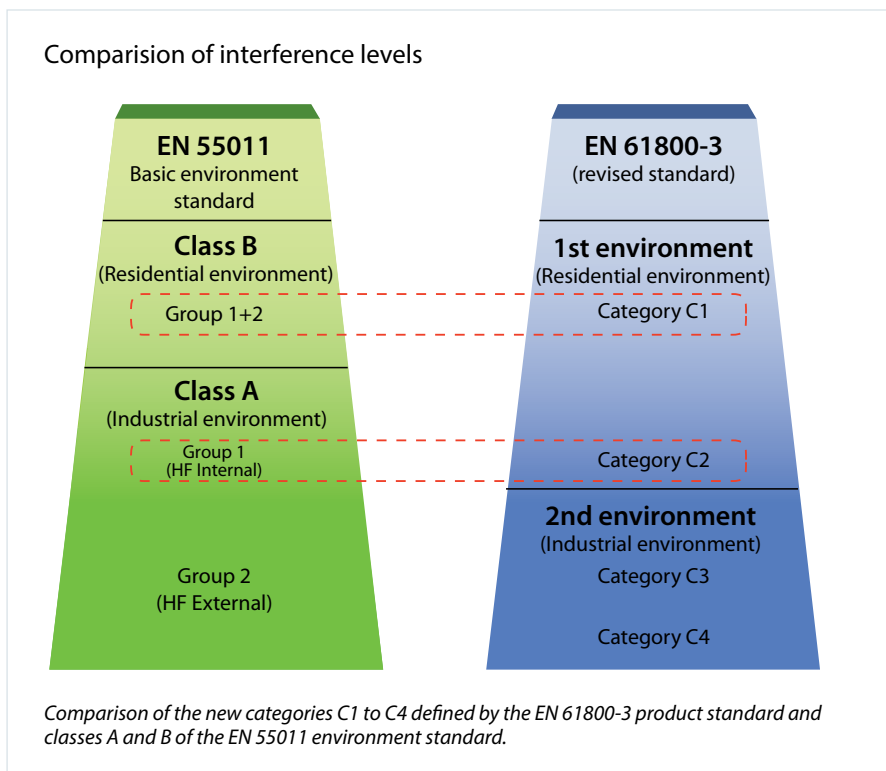

EN 61800-3 product standard (2005-07) for electrical drive systems				
Classification by category	C1	C2	C3	C4
Environment	1st Environment	1st or 2nd Environment (operator decision)	2nd Environment	2nd Environment
Voltage/current	< 1000 V			> 1000 V In > 400 A Connection to IT network
EMC expertise	No requirement	Installation and commissioning by an EMC expert		EMC plan required
Limits according to EN 55011	Class B	Class A1 (plus warning notice)	Class A2 (plus warning notice)	Values exceed Class A2

Classification of the new categories C1 to C4 of the EN 61800-3 product standard

Note:

Facility operators must comply with EN 55011 in case of problems. Converter manufacturers must conform to EN 61800-3.

Practical aspects of 1st and 2nd environment

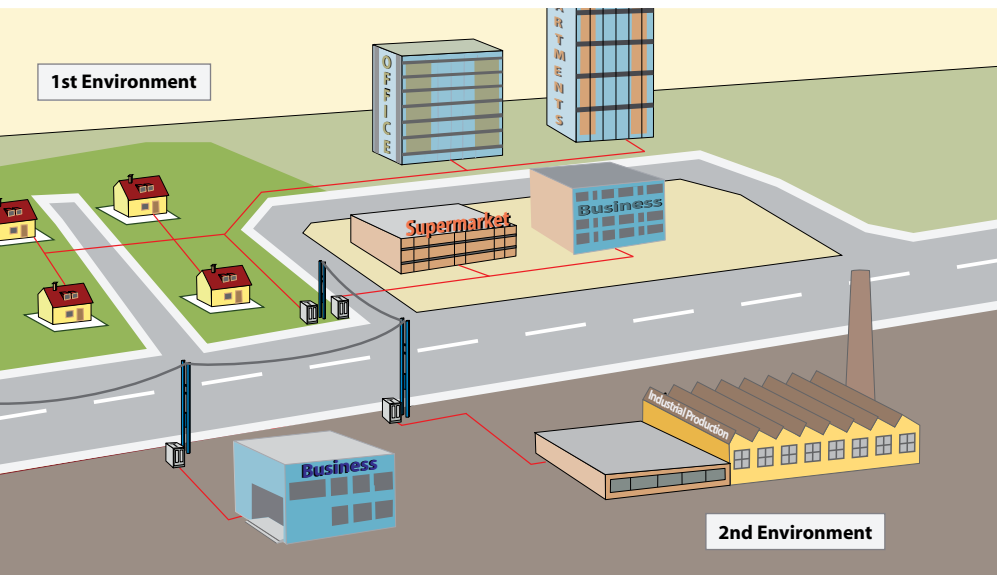

Classification of operating environments in 1st and 2nd and special environments in which the operator is allowed a choice.

instead have their own high-voltage or medium-voltage distribution transformers. They are also defined as such in the land register and are characterised by specific electromagnetic conditions:

- the presence of scientific, medical or industrial devices;
- switching of large inductive and capacitive loads;
- occurrence of strong magnetic fields (for example, due to high currents).

The environment classifications apply both inside and outside the buildings.

Special environments

Here the users may decide which type of environment to classify their facility in. This presumes that the area has its own medium-voltage transformer and is clearly demarcated from other areas. Within this area, the user is personally responsible for ensuring the electromagnetic compatibility necessary to enable the trouble-free operation of all devices under certain conditions. Some examples of special environments are shopping centres, supermarkets, filling stations, office buildings and warehouses.

No compromises

If a frequency converter that does not conform to Category C1 is used, the device must be provided with a warning notice. This is the responsibility of the user or the operator. In case of interference, experts always base interference elimination on the limits defined for classes A1/A2 and B in the EN 55011 generic standard according to the operating environment. The cost of remedying EMC problems is borne by the operator. The user is ultimately responsible for the appropriate classification of devices with respect to these two standards.

The operating site is the decisive factor

The limits for each environment are specified by the corresponding standards, but how are devices assigned to the different environment types? Here again the EN 55011 and EN 61800-3 standards provide information regarding electrical drive systems and components.

commercial environments. They do not have their own high-voltage or medium-voltage distribution transformers for a separate mains system. The environment classifications apply both inside and outside buildings. Some examples are business areas, residential buildings and residential areas, restaurant and leisure businesses, car parks, entertainment facilities and sports facilities.

1st Environment/ Class B: Residential environment

All operating sites directly connected to the public low voltage power grid, including light industrial areas, are classified as residential or business and

2nd Environment/ Class A: Industrial environment

Industrial environments are operating sites that are not connected directly to the public low-voltage power grid, but

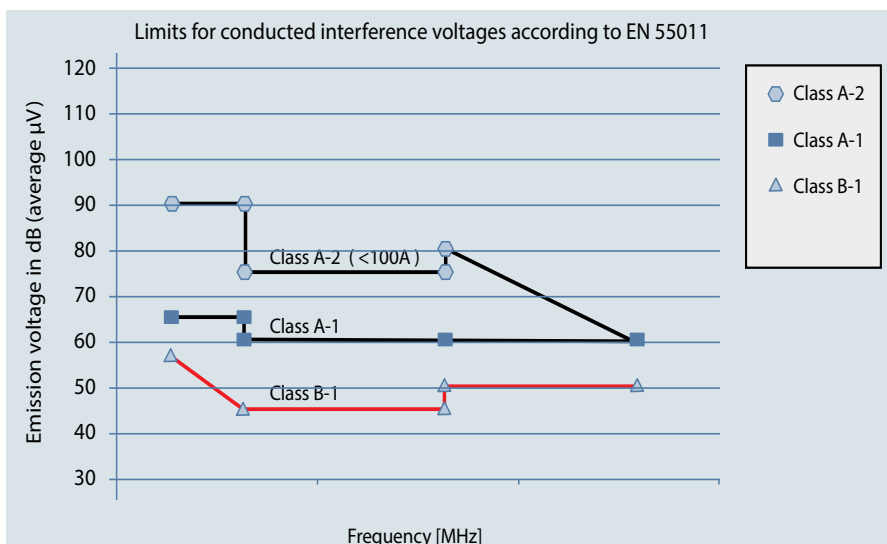

Practical aspects of mains protection measures

Power factor correction

Power factor correction equipment serves to reduce the phase shift (φ) between the voltage and the current and moves power factor closer to unity ($\cos \varphi$). This is necessary when a large number of inductive loads, such as motors or lamp ballasts, are used in an electrical distribution system. Depending on the design of the DC link, frequency converters do not draw any reactive power from the mains system or generate any phase shift. They have a $\cos \varphi$ of approximately 1. For this reason, users of speed-controlled motors do not have to take them into account when dimensioning any power factor correction equipment that may be necessary. However, the current drawn by the phase correction equipment rises because frequency converters generate harmonics. The load on the capacitors increases as the number of harmonic generators increases, and they heat up more. For these reasons, the operator must fit chokes in power factor correction equipment. These chokes also prevent resonances between load inductances and the capacitance of the power factor correction equipment.

Converters with $\cos j < 1$ also require chokes in the power factor correction

equipment. The user must take the higher reactive power level into account when dimensioning the cables.

Mains transients

Transients are brief voltage peaks in the range of a few thousand volts. They can occur in all types of power distribution systems, in both industrial and residential environments.

Lightning strikes are a common cause of transients. However, they are also caused by switching large loads on line or off line or switching other equipment, such as power factor correction equipment. Short circuits, tripping of circuit breakers in power distribution systems, and inductive coupling between parallel cables can also cause transients.

The EN 61000-4-1 standard describes the forms of these transients and how much energy they contain. Their harmful effects can be limited by various methods. Gas-filled surge arresters and spark gaps are used to provide first-level protection against high-energy transients. For second-level protection, most electronic devices use voltage-dependent resistors (varistors) to attenuate transients. Frequency converters also utilise this method.

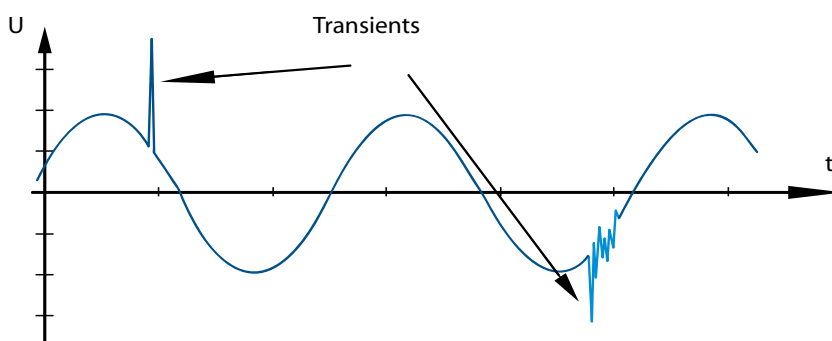

Lightning strikes are the most frequent cause of mains transients in water and wastewater treatment plants.



Practical aspects of operation with a transformer or standby generator

Maximum transformer utilisation

In low-voltage systems (400 V, 500 V and 690 V), operators may use speed-controlled drives with ratings up to around 1 MW. A transformer converts the voltage of the medium-voltage grid to the required voltage. In the public power grid (environment 1: residential environment) this is the responsibility of the electricity company.

In industrial mains systems (environment 2: industrial environment; usually 500 V or 690 V), the transformer is located on the premises of the end user, who is also responsible for feeding power to the user's facility.

Transformer load

In case of transformers that supply power to frequency converters, it must be borne in mind that the use of frequency converters and other rectifier loads causes the generation of harmonics that put an extra reactive power load on the transformer.

This causes higher losses and additional heating. In the worst case, this can lead to the destruction of the transformer. Intelligent vector groups (several transformers connected together) may also generate harmonics under certain conditions.

Power quality

To ensure the quality of the mains power in accordance with the applicable standards, you need to know how much frequency converter load the transformer can handle.

Mains analysis programs such as the VLT® MCT 31 Harmonic Calculation software provide an exact indication of how much frequency converter load a transformer can supply in a specific system.

Remark: All frequency converters in the VLT® AQUA Drive series are equipped with integrated mains interference chokes as standard.

Operation with a standby generator

Operators use backup power systems when the continued operation of mains-powered devices is necessary even in the event of mains failure. They are also used when the available mains connection cannot provide sufficient power. Operation in parallel with the public power grid is also possible in order to achieve higher mains power. This is common practice when heat is also needed, such as with combined heat and power units. They take advantage of the high efficiency that can be achieved with this form of energy conversion. When backup power is provided by a generator, the mains impedance is usually higher than when power is taken from public grid. This causes the total harmonic distortion to increase. With proper design, generators can operate in a system containing harmonic generators.

In practice, this means that when the system is switched from mains operation to generator feed, the harmonic load can usually be expected to increase.

Facility services designers and operators should calculate or measure the increase in the harmonic load in order to ensure that the power quality conforms to regulations and thereby to prevent problems and equipment failure.

Asymmetric loading of the generator must be avoided, since it causes increased losses and may cause the total harmonic distortion to increase. A 5/6 stagger of the generator winding attenuates the fifth and seventh harmonics, but it allows the third harmonic to increase. A 2/3 stagger reduces the third harmonic. If possible, the operator should disconnect power factor correction equipment because resonances may occur in the system.

Chokes or active absorption filters can attenuate harmonics. Resistive loads operated in parallel also have an attenuating effect, while capacitive loads operated in parallel create an additional load due to unpredictable resonance effects.

If these phenomena are taken into account, a mains system fed by a generator can power a certain proportion of frequency converters while still maintaining the specified power quality. A more precise analysis is possible using mains analysis software, such as the VLT® MCT 31 Harmonic Calculation software.

In case of operation with harmonic generators, the limits are set as follows:

B2 and B6 rectifiers	→	max. 20% of rated generator load
B6 rectifier with choke	→	max. 20–35% of rated generator load depending on the composition
Controlled B6 rectifier	→	max. 10% of rated generator load

The above maximum load figures are recommended guideline values, which based on experience allow trouble-free facility operation.

Step 2: Practical aspects of ambient and environmental conditions

The right installation location

Maximum up-time and long service life of frequency converters in operational use are only possible with proper cooling and clean air.

Consequently, selection of the installation location and the installation conditions have a decisive effect on the lifetime of the frequency converter.

Cabinet mount versus wall mount

There is no cut-and-dried answer to the question of whether a frequency converter should be mounted in a cabinet or on the wall. Both options have their pros and cons.

Cabinet mounting has the advantage that all electrical and electronic components are located close together and protected by an enclosure (the cabinet).

The cabinet also comes fully assembled as a complete unit for installation in the facility.

A drawback is that the components may affect each other due to the close spacing inside the cabinet, which means that particular attention must be given to EMC-compliant cabinet layout. In addition, the investment

costs for shielded motor cables are higher because the frequency converter and motor are usually significantly further away from each other than with local installation.

Wall mounting is easier to handle in terms of EMC due to the close proximity of the frequency converter and the motor.

Shielded motor cables are reduced in length and accordingly represent significantly lower cost. The slightly higher cost of a frequency converter with an IP54 enclosure can easily be offset by the reduced cabling and installation cost. However, in practice around 70% of the devices are mounted in cabinets.

Remark:

Danfoss frequency converters are available with three different protection ratings:

- IP00 or IP20 for cabinet installation
- IP54 or IP55 for local mounting;
- IP66 for critical ambient conditions, such as extremely high (air) humidity or high concentrations of dust or aggressive gases.



Frequency converters can be installed centrally (in a cabinet) or locally (close to the motor). Both options have advantages and drawbacks.

Practical aspects of IP ratings



Scoop-proof converters with protection rating IP20 or IP21 (right) are intended for cabinet mounting. Splash-proof converters with IP54 or IP55 protection rating (left) are designed for wall or frame mounting.

IP rating structure according to IEC 60529

	Against penetration by solid foreign objects	Against access to hazardous parts by
First digit	0 (not protected)	(not protected)
	1 ≥ 50 mm diameter	Back of hand
	2 12.5 mm diameter	Finger
	3 2.5 mm diameter	Tool
	4 ≥ 1.0 mm diameter	Wire
	5 Dust protected	Wire
	6 Dust-tight	Wire
	Against water penetration with harmful effect	
Second digit	0 (not protected)	
	1 Drops falling vertically	
	2 Drops at 15° angle	
	3 Spraying water	
	4 Splashing water	
	5 Water jets	
	6 Powerful water jets	
	7 Temporary immersion	
	8 Long-term immersion	
	Additional information specifically for	
First digit	A	Back of hand
	B	Finger
	C	Tool
	D	Wire
	Additional information specifically for	
Additional letter	H	High-voltage device
	M	Device moving during water test
	S	Device stationary during water test
	W	Weather conditions

Missing digits are replaced by "x".

Practical aspects of cooling design

Compliance with ambient temperature specifications

External climatic conditions and ambient conditions have a distinct effect on the cooling of all electrical and electronic components in a control room or cabinet.

Minimum and maximum ambient temperature limits are specified for all frequency converters. These limits are usually determined by the electronic components that are used. For example, the ambient temperature of the electrolytic capacitors installed in the DC link must remain within certain limits due to the temperature dependence of their capacitance. Although frequency converters can operate at temperatures down to -10 °C, manufacturers only guarantee proper operation at rated load with temperatures of 0 °C or higher. This means that you should avoid using them in areas subject to frost, such as uninsulated rooms.

You should also not exceed the maximum temperature limit. Electronic components are sensitive to heat.

According to the Arrhenius equation, the lifetime of an electronic component decreases by 50% for every 10 °C that it is operated above its design temperature. This is not limited to devices that are installed in cabinets. Even devices with IP54, IP55 or IP66 protection ratings can only be used within the ambient temperature ranges specified in the manuals. This sometimes requires air conditioning of installation rooms or cabinets. Avoiding extreme ambient temperatures prolongs the life of frequency converters and thereby the reliability of the overall system.

The intelligent cooling design of VLT® frequency converters remove up to 85% of the dissipated heat from the device enclosure via cooling ducts.

Cooling

Frequency converters dissipate power in the form of heat. The amount of power dissipation in watts is stated in the technical data of the frequency converter. Operators should take suitable measures to remove the heat dissipated by the frequency converter from the cabinet, for example by means of cabinet fans. The required air flow is stated in the manufacturer documentation. Frequency converters must be mounted such that the cooling air can flow unhindered through the device's cooling fins.

Particularly with IP20 devices in cabinets, there is a risk of inadequate air circulation due to the closely spaced mounting of cabinet components, which causes the formation of heat pockets. See the manuals for the correct mounting distances, which must always be observed.

Relative humidity

Although some frequency converters can operate properly at relatively high humidity (Danfoss units up to 95% relative humidity), condensation must always be avoided. There is a

specific risk of condensation when the frequency converter or some of its components are colder than moist ambient air. In this situation, the moisture in the air can condense on the electronic components.

When the device is switched on again, the water droplets can cause short circuits in the device. This usually occurs only with frequency converters that are disconnected from the mains. For this reason, it is advisable to install a cabinet heater in situations where there is a real possibility of condensation due to ambient conditions. Alternatively, operating the frequency converter in standby mode (with the device constantly connected to the mains) can help reduce the risk of condensation. However, you should check whether the power dissipation is sufficient to keep the circuitry in the frequency converter dry.

Note: Some manufacturers specify minimum side clearances as well as minimum top and bottom clearances. Observe these specifications.

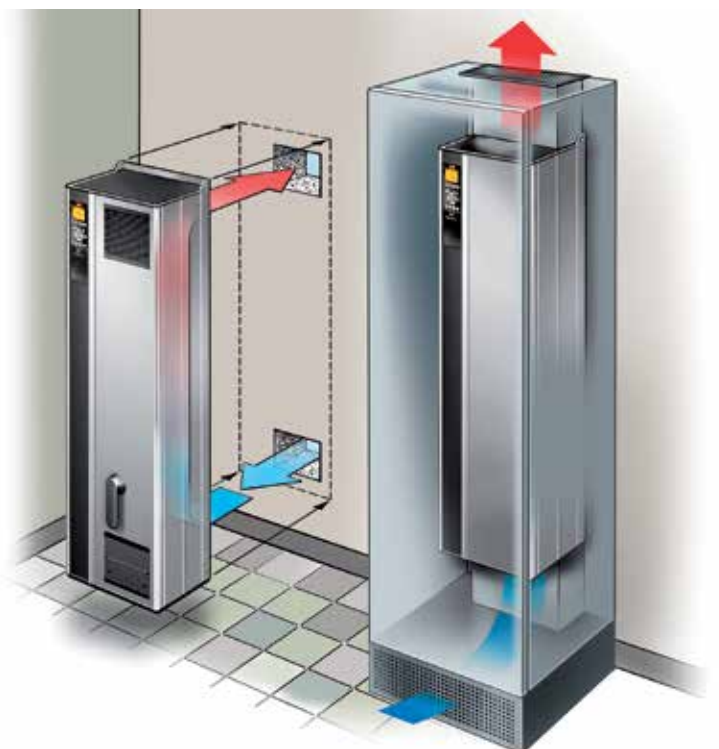

Practical aspects of special requirements

Ambient parameters	Unit	Class				
		3C1	3C2		3C3	
			Average value	Max. value	Average value	Max. value
Sea salt	mg/m ³	No	Salt mist		Salt mist	
Sulphur oxides	mg/ m ³	0.1	0.3	1.0	5.0	10
Hydrogen sulphide	mg/ m ³	0.01	0.1	0.5	3.0	10
Chlorine	mg/ m ³	0.01	0.1	0.03	0.3	1.0
Hydrogen chloride	mg/ m ³	0.01	0.1	0.5	1.0	5.0
Hydrogen fluoride	mg/ m ³	0.003	0.01	0.03	0.1	3.0
Ammonia	mg/ m ³	0.3	1.0	3.0	10	35
Ozone	mg/ m ³	0.01	0.05	0.1	0.1	0.3
Nitrogen	mg/ m ³	0.1	0.5	1.0	3.0	9.0

Classification according to IEC 60721-3-3; average values are anticipated long-term values. Maximum values are transient peak values that do not occur longer than 30 minutes per day.

Aggressive atmosphere or gases

Aggressive gases, such as hydrogen sulphide, chlorine or ammonia, are often present in sewage treatment plants or swimming pools. Contamination of the cooling air can cause the gradual decomposition of electronic components and PCB tracks in frequency converters. Electronic devices in electrical systems or cabinets are especially susceptible. If the ambient air is contaminated in this manner, the operator or plant engineer should either install the frequency converter in a location where the possibility of contamination can reliably be excluded (a different building, a

sealed cabinet with a heat exchanger, etc.) or order devices whose circuit boards are coated with a special protective varnish that is resistant to the aggressive gases.

A clear sign of an aggressive atmosphere is the corrosion of copper. If it quickly turns dark, forms blisters or even decomposes, circuit boards or devices with a supplementary coating should be used. The specific media and media concentrations that a coating can resist are described in international standard IEC 60721-3-3.

Note: You should consider in the design and project engineering phase where the cooling air for the electronic equipment will come from. For example, in a sewage treatment plant you should avoid drawing air from the inflow area, and with a swimming pool you should avoid drawing air from the water treatment area.

Remark: VLT® AQUA Drive units come standard with class 3C2 coating. On request, class 3C3 coating is also available.

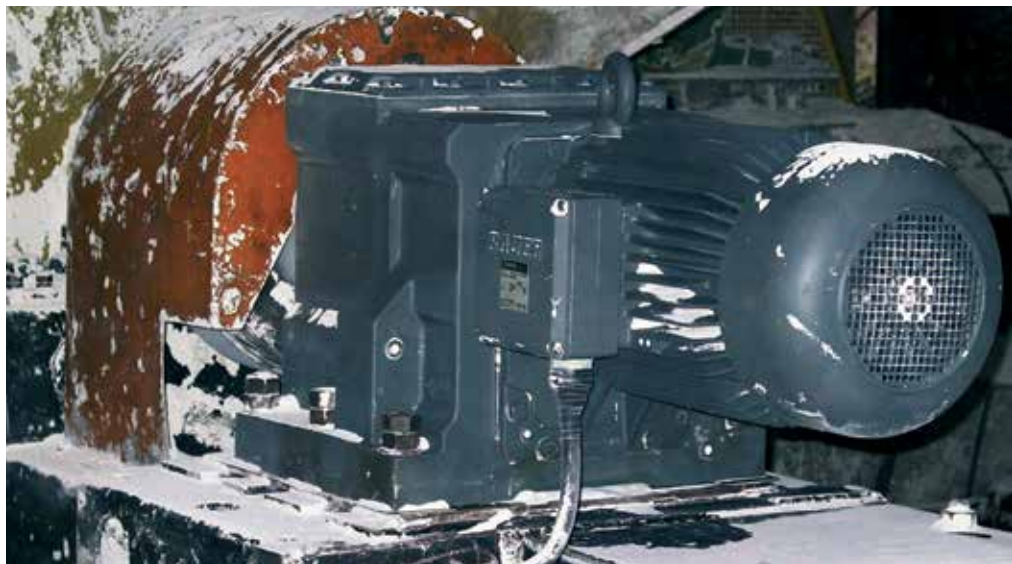

Dust exposure

Installation of frequency converters in environments with high dust exposure is often unavoidable in practice. This dust forms deposits everywhere and penetrates into even the smallest cracks. This affects not only locally mounted frequency converters (wall or frame mount) with IP55 or IP66 protection rating, but also cabinet-mounted devices with IP21 or IP20 protection rating.

The three aspects described below must be taken into account when frequency converters are installed in such environments.

Reduced cooling

The dust forms deposits on the surface of the device and inside the device on the circuit boards and the electronic components. These deposits act as insulation layers and hamper heat transfer from the components to the ambient air. This reduces the

cooling capacity. The components become warmer. This causes accelerated aging of the electronic components, and the service life of the affected frequency converter decreases. The same thing happens when dust deposits form on the heat sink on the back of the frequency converter.

Cooling fans

The air flow for cooling frequency converters is produced by cooling fans, which are usually located on the back of the device. The fan rotors have small bearings into which dust penetrates and acts as an abrasive. This leads to fan failure due to bearing damage.

Filter mats

High-power frequency converters in particular are equipped with cooling fans that expel hot air from the interior of the device. Above a certain size, these fans are fitted with filter mats

that prevent the entry of dust into the device. These filter mats quickly become clogged when they are used in very dusty environments, and the fans are no longer able to cool adequately the components inside the frequency converter.

Note: Under the conditions described above, it is advisable to clean the frequency converter during periodic maintenance. Blow the dust off the heat sink and fans and clean the filter mats.

Practical aspects of potentially explosive atmospheres

Potentially explosive atmospheres

Ex d: Flameproof protection

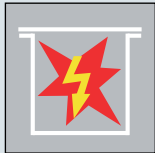

With ignition protection class “d”, the device is designed to ensure that if a spark occurs in a protected area (such as inside an enclosure), it cannot leave the protected area.

Ex e: Increased safety

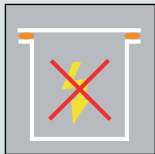

With ignition protection class “e”, the protection consists of preventing the occurrence of sufficient energy to cause sparking.

Note: Never install a frequency converter directly in an area with a potentially explosive atmosphere. It must be installed in a cabinet outside this area. Using a sine-wave filter at the output of the frequency converter is also recommended because it attenuates the voltage rate of rise du/dt and the peak voltage U_{peak} . The connected motor cable should be kept as short as possible due to the voltage drop in the cable.

Remark: Danfoss VLT® AQUA Drive frequency converters with the MCB 112 option have PTB-certified motor thermistor sensor monitoring capability for potentially explosive atmospheres. Shielded motor cables are not necessary when VLT® frequency converters are operated with sine-wave output filters.

Drive systems often operate in potentially explosive atmospheres. One example is the inflow area of a sewage treatment plant. If frequency converters are used for speed control of drives in such areas, the facility must fulfil special conditions. The basis for this is provided by EU Directive 94/9/EC, which is called the ATEX directive. It describes the use and operation of equipment and protective devices in potentially explosive atmospheres. This directive harmonises regulations and requirements throughout the EU for the operation of electrical and electronic devices in potentially explosive atmospheres, such as may be caused by dust or gases.

If frequency converters are used to control motors in potentially explosive atmospheres, these motors must be equipped with temperature monitoring using a PTC temperature sensor. Motors with ignition protection class “d” or “e” may be used. These ignition protection classes differ in terms of how the ignition of an explosive medium is prevented. In practice, frequency converters are rarely used with “e” class motors. This combination must be approved as an unit, which involves elaborate and expensive type testing. However, the PTB in Braunschweig (Germany) has developed a new approval procedure that will make the use of speed

controllers with class “e” motors considerably more attractive in the future. The new concept calls for the acceptance of only the motor itself, while additionally defining specific requirements for thermal monitoring in the EC type test certification process. For instance, speed-dependent current limiting is required in addition to the usual certified PTC thermistor monitoring, in order to deal with the reduced cooling of self-ventilated motors with variable speed control.

Although this does not require separate approval of class “d” motors, feeding cables into the “d” area is very complicated. Motors with protection class “de” are the most widely used. In this case the motor itself has a “d” ignition protection class, while the connection space is implemented in compliance with the “e” ignition protection class. The restriction on the “e” connection space consists of the maximum voltage that may be fed into this space. Due to pulse-width modulation of the output voltage, most frequency converter outputs have peak voltages that exceed the allowable limits of class “e” ignition protection. In practice, using a sine-wave filter at the frequency converter output has proven to be an effective way to attenuate the high peak voltages.

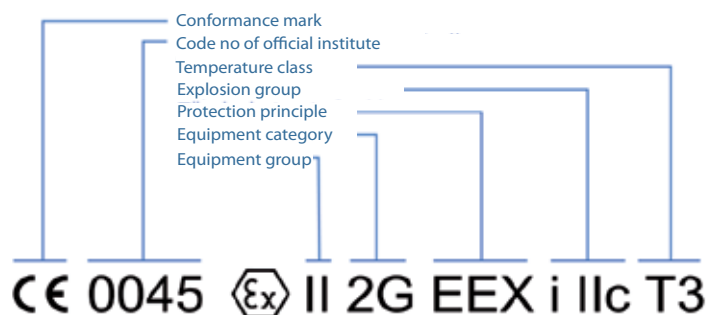

Labelling of devices for operation in potentially explosive atmospheres in accordance with the ATEX product directive (94/9/EC)

Step 3: Practical aspects of motors and cabling

Minimum efficiency performance classes for motors

Mandatory minimum efficiencies

Efficiency classification arose in 1998 as a result of a voluntary commitment by the European Committee of Manufacturers of Electrical Machines and Power Electronics (CEMEP) Starting in the summer of 2011, three-phase asynchronous motors are subject to mandatory minimum efficiency performance standards (MEPS) in the EU. EU regulations provide for increasingly strict motor efficiency requirements in a staged process extending to 2017.

The basis for these minimum efficiency classes, which are also called minimum energy performance standards (MEPS), is formed by the International Efficiency (IE) classes defined in IEC 60034-30, which are internationally

recognised. The limits of these classes are in part comparable to those of the Eff classes widely used in Europe.

IE and Eff classes: major differences in details

Although the limits of the two standards are comparable, they differ in the underlying methods for determining efficiency. The efficiency of the Eff classes is based on the determination of individual losses (IEC 60034-2:1996), a method that dates back 100 years. By contrast, the efficiency of the IE classes is determined using a more precise method.

The measured results obtained using the accepted method for the IE classes are usually 2 to 3% worse than

with the old method at power levels up to 10 kW and around 1% worse at power levels of 100 kW and above. The standard takes these differences into account for the harmonisation of the IE and Eff classes.

In addition to the IE1 to IE3 classes defined by the IEC 60034-30 standard, the draft version of IEC 60034-31 defines a new class: IE4. Classes IE1 to IE3 are primarily oriented towards mains-operated motors, while IE4 also takes aspects relevant to variable-speed motors into account.

IE4 is presently not mandatory; it is used at present only for comparison with other efficiency classes.

IEC 60034-30	Eff classes
IE1 (Standard Efficiency)	Comparable to Eff2
IE2 (High Efficiency)	Comparable to Eff1
IE3 (Premium Efficiency)	Approximately 15–20% better than IE2

Efficiency classes IE1–IE3 are defined in international standard IEC 60034-30. The Eff classes are based on a voluntary agreement between the EU and the CEMEP in 1998.

Affected three-phase motors

Compliance with the MEPS is mandatory for the following types of three-phase motors:

- Duty cycle S1 (continuous duty) or S3 (intermittent periodic duty) with a duty cycle greater than 80%
- Pole count 2 to 6 Rated power 0.75 to 375 kW
- Rated voltage up to 1000 V.

Introduction of the MEPS is intended to help reduce energy consumption. However, in rare cases this approach can result in increased energy consumption. For this reason, EU Ordinance 640/2009 describes technically reasonable exceptions for various application areas.

They include:

- Motors in potentially explosive atmospheres (as mentioned in Directive 94/9/EC) and brake motors
- Special motors for use under any of the following operating conditions:
 - ambient temperatures above 40 °C;
 - ambient temperatures below 15 °C (0 °C for air-cooled motors); operating temperatures above 400 °C; cooling water temperatures below 5 °C or above 25 °C;
 - operation at elevations above 1000 m;

- motors fully integrated in a product, such as geared motors, pumps or fans, or which (e.g. submersible pumps) are fully surrounded by a fluid medium in operation.

Within Europe, the motor of a geared motor is not regarded as an integral constituent and is measured separately. A similar method is used with special motors. The base motor is measured, and the efficiency class is transferred to the motor variants.

Practical aspects of IE classification of motors

Schedule for MEPS implementation

The schedule in the EU ordinance provides for a staged increase in motor efficiency requirements. After the scheduled dates, all three-phase motors subject to the ordinance must fulfil the requirements of the specified efficiency class if they are to be marketed in Europe.

IE2 motors powered by converters are also accepted as an MEPS alternative to the planned IE3 class. Compliance

with class IE3 or the alternative of IE2 with a converter must be ensured at the operating site.

	Power	MEPS	MEPS alternative
Starting 16 June 2011	0.75 – 375 kW	IE2	-
Starting 1 January 2015	0.75 – 7.5 kW	IE2	-
	7.5 – 375 kW	IE3	IE2 with converter
Starting 1 January 2017	0.75 – 375 kW	IE3	IE2 with converter

Schedule for MEPS implementation

Compliance with EN 50347 mounting dimension specifications

Synchronous three-phase motors conforming to classes IE2 and IE3 are often larger than motors with lower efficiency. This can lead to problems in the replacement of older motors.

Most IE2 motors conform to the shaft heights and fixing dimensions

standardised by EN 50347, but the construction form is often longer. In many cases, small 50-Hz IE3 Premium Class motors will not conform to the

EN 50347 mounting dimensions. Facility operators should take heed of this in their motor replacement schemes. Alternative to IE3: IE2 plus converter.

	Motor		
	IE1	IE2	IE3
Shaft height (EN 50347)	Yes	Yes	Larger
Fixing dimensions (EN 50347)	Yes	Yes	Larger
Motor length	Yes	Longer	Larger

It is currently expected that class IE2 and IE3 synchronous three-phase motors will not be able to conform to the mounting dimensions defined in EN 50347.

Cost-effectiveness

A justified question with regard to the introduction of IE motors is: how cost-effective are they? The higher efficiency is in part achieved by employing a higher proportion of active materials in the motors. Depending on the motor size, you can assume that a motor with a better efficiency class costs approximately 10 to 20% more.

In practice, this additional cost can often be recovered quickly. The chart shows the energy cost advantage of an IE motor compared to an IE motor in the next class. This simplified analysis is based on continuous operation at the rated load, 60,000 operating hours, and an electricity price of 8 Euro cents per kilowatt-hour.

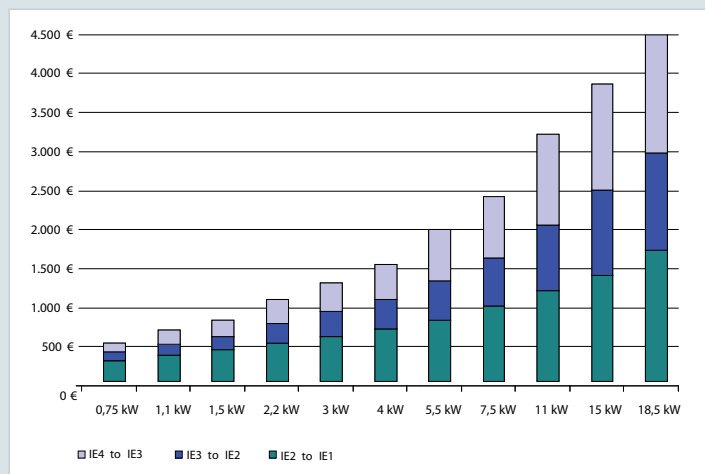

Energy cost advantage of an IE motor relative to the next IE class

Note: The full text of EU Ordinance 640/2009 can be downloaded free of charge from the www.eur-lex.europa.eu website.

Practical aspects of EC and PM motors

Many names for the same technology

It takes a lot of effort to increase the efficiency of a three-phase induction motor (TPIM). This makes permanent-magnet synchronous motors a good alternative. Compared with induction motors offering similar efficiency (e.g. IE 3), they are significantly more compact.

In practice, as a user you will encounter various subcategories of these motors with different names. The abbreviations "PM" (permanent magnet) and "PMSM" (permanent magnet synchronous motor) are often used in the industry, while the designations "EC" (electronically commutated) and "BLDC" (brushless direct current) are more commonly used in building automation.

The variety and diversity of names given to permanent magnet motors can be illustrated by taking EC motors as an example. EC motors are usually used as servo motors or stepper motors in industrial applications. With a small, compact frame size, they cover a power range extending to approximately 300 watts. The most common supply voltage is 24 V.

The situation is different in fan systems for building automation. There, single-phase and three-phase EC motors operate in compact fan units for applications with power requirements in the single-figure kilowatt range.

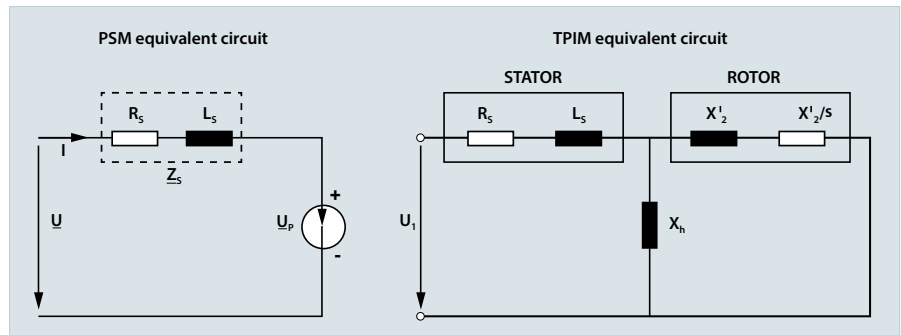

Comparison of the simplified equivalent circuits shows that PM/EC motors do not have any rotor losses. This yields a higher level of efficiency compared to three-phase motors.

The technology

Due to the built-in permanent magnets, permanently excited motors do not need a separate excitation winding. However, they need an electronic controller that generates a rotating field. Operation directly from the mains is generally not possible, or in many cases only with reduced efficiency. To drive the motor, the controller (e.g. a frequency converter) must be able to constantly determine the current position of the rotor. Two methods are used for this, either with or without feedback on the current rotor position provided by a sensor or an encoder.

High efficiency

Using permanent magnets in the rotor virtually eliminates rotor losses in the motor. This results in increased efficiency.

The Danfoss EC+ concept

allows PM motors with IEC standard dimensions to be used with Danfoss VLT® frequency converters. Danfoss has integrated the necessary control algorithm in the existing VLT® converter series. This means that there are no changes for the operator. After entering the relevant motor data, the user benefits from the high motor efficiency of EC technology.

Advantages of the EC+ concept

- Free choice of motor technology: PM or asynchronous with the same frequency converter
- Device installation and operation remain unchanged
- Manufacturer independence in the choice of all components
- Superior system efficiency thanks to a combination of individual components with optimum efficiency
- Retrofitting of existing systems possible
- Wide range of rated powers for standard and PM motors

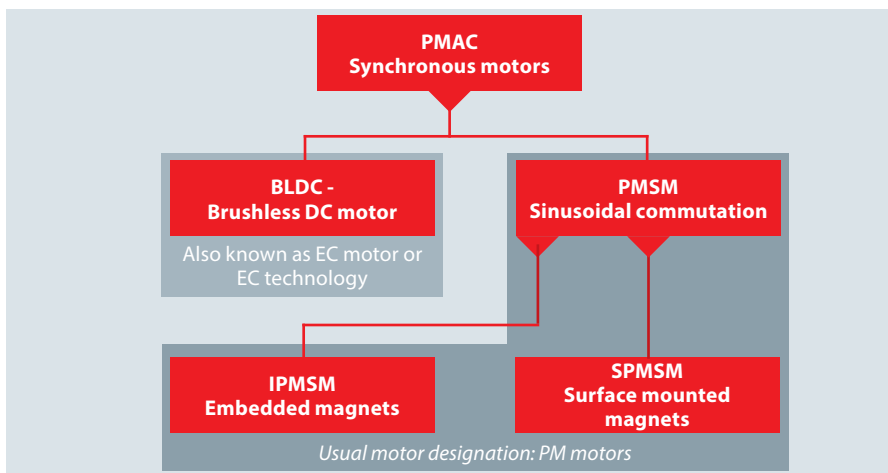

PMAC = Permanent Magnet AC; BLDC = Brushless DC; PMSM = Permanent Magnet Synchronous Motor; IPMSM = Interior PMSM (embedded magnets); SPMSM = Surface PMSM (magnets mounted on rotor)

Practical aspects of EC and PM motors

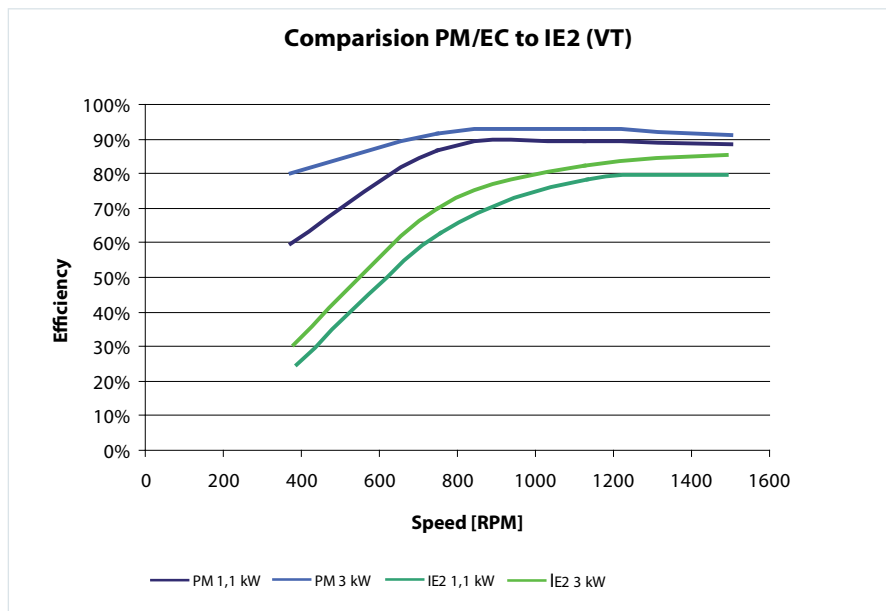

The diagram shows values measured by an independent university. Losses for the required control electronics are included in the figures.

Oversynchronous operation

In theory, it is possible to operate an EC or PM motor above its rated frequency or rated speed, as long as this is allowed by the manufacturer. With a TPIM, this is called oversynchronous operation or operation with field weakening. Field weakening allows the motor to be operated at a higher speed, but with lower output shaft torque. In contrast to TPIMs, with EC or PM motors field weakening can only be achieved by using suitable drive signals. As with TPIMs, this reduces the output shaft torque. The motor manufacturer must be consulted to determine whether a particular motor is suitable for supersynchronous operation.

With regard to the frequency converter, this type of operation does not present a problem unless the back EMF (ElectroMotiveForce) generated by the EC or PM motor due to the permanent magnets exceeds the allowable DC link voltage of the converter.

For example, a motor with a back EMF of 200 V at 1,000 rpm can be operated at speeds up to 3,192 rpm with a frequency converter having a maximum allowable DC link voltage of 900 V. Although the motor can be operated at even higher speeds, this poses a risk of electrical failure of the converter in the event of a fault because the voltage is higher than 900 V. For example, this could happen if there is a mains drop-out.

Standard IEC enclosure

Many applications employ three-phase induction motors whose installation dimensions and frame sizes comply with the specifications of IEC EN 50487 or IEC 72.

However, other types of construction have been used for most PM motors up to now. Servo motors are typical examples. With their compact construction and long rotors, they are optimised for highly dynamic processes.

To allow the high efficiency of permanent magnet motors to be utilised in existing industrial applications, PM motors are now available with standard IEC motor enclosures. This allows older-model standard three-phase induction motors (TPIMs) to be replaced by motors with higher efficiency in existing systems. This also enables mechanical engineering and plant engineering firms to use motors with higher efficiency without requiring any design changes to existing machines.

For compatibility reasons, both forms of PM motors are commercially available.

Option 1: Same frame size

The PM/EC motor and the TPIM have the same frame size.

Example: A 3 kW TPIM can be replaced by an EC/PM motor of the same size.

Option 2: Same power rating

The PM/EC motor and the TPIM have the same power rating. In theory, a PMSM can be made smaller than a TPIM with a comparable power rating. Depending on the frame size, the power density of a PM/EC motor is approximately 1.5 to 2 times that of a TPIM.

Example 1: A 3 kW TPIM can be replaced by an EC/PM motor with the same frame size as a 1.5 kW motor.

Example 2: A 3 kW TPIM can be replaced by an EC/PM Motor with the same frame size and a 6 kW power rating.

However, a controller is always necessary to drive a PM/EC motor.

Practical aspects of motor suitability for frequency converter operation

Selection criteria

The following aspects must be taken into consideration in connection with motors controlled by frequency converters:

- Insulation stress
- Vearing stress
- Thermal stress

Insulation stress

Operating a motor with frequency control imposes higher stress on the motor winding than direct mains operation. This is primarily due to the steep pulse edges (du/dt) and the motor cable, depending on cable length, type, routing, etc.

The steep pulse edges result from the rapidly switching semiconductor devices in the inverter stage of the frequency converter. They operate at a high switching frequency in the range of 2 to 20 kHz with very short switching times in order to reproduce a sinusoidal waveform.

In combination with the motor cable, these steep pulse edges are responsible for the following effects at the motor:

- High pulse voltages U_{LL} on the motor terminals put additional stress on the interwinding insulation

- Higher pulse voltages between the windings and the laminations \hat{U}_{LE} put additional stress on the slot insulation
- Higher voltages between the windings \hat{U}_{wdg} put significantly higher stress on the insulation of the wire in the windings.

Bearing stress

Under unfavourable conditions, frequency-controlled motors may fail due to bearing damage caused by bearing currents. Current flows in a bearing when the voltage across the bearing lubrication gap is high enough to penetrate the insulation layer formed by the lubricant. If this happens, imminent failure of the bearing is signalled by increasingly louder bearing noise. Bearing currents of this sort include high-frequency eddy currents, earth currents and EMD currents (spark erosion).

Which of these currents may lead to bearing damage depends on the following factors:

- The mains voltage at input of the frequency converter
- The steepness of the pulse edges (du/dt)
- The type of motor cable

- Electrical shielding
- System earthing
- Motor size
- The earthing system of the motor housing and the motor shaft.

Bearing currents can be reduced by the following measures:

- Fitting output filters (output chokes, du/dt filters, or sine-wave filters)
- Fitting electrically insulated bearings
- Good earthing of all metallic system components with low-impedance connections
- Shielded motor cables
- Fitting a DC suppression filter.

Thermal stress

Operation with a frequency converter increases the power dissipation in the motor. The additional harmonic content causes iron losses and current heat losses in the stator and rotor. The magnitude of the losses depends on the amplitude and frequency of the harmonics of the drive frequency. The additional current heat losses in the rotor depend on the slot geometry. Iron losses and current heat losses in motors are not load-dependent. The additional losses in the motor cause higher thermal stress on the winding insulation. However, with modern frequency converters the additional heating of standard motors (up to frame size 315) is comparable to the additional warming due to mains voltage tolerances and is therefore negligible. Manufacturers sometime specify a derating factor for trans-standard motors (frame size 355 and above).

If the converter is not able to generate the full mains voltage at the rated mains frequency, it is advisable to select a motor with Class F insulation. Operating a motor at a voltage lower than with direct mains operation increases the motor temperature by up to 10 K.

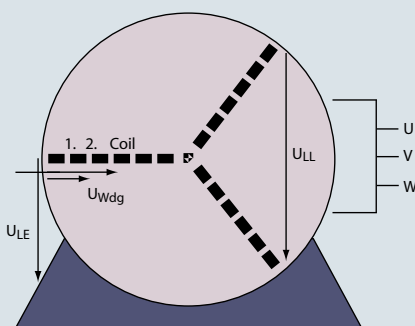

Pulse voltages appear in the motor at the motor terminals (U_{LL}) and between the windings and the lamination stack (U_{LE}). There is also a voltage stress between the windings (U_{wdg}).

Note: Request confirmation from the motor manufacturer that the motor is designed for operation with a frequency converter and confirmation of the allowable operating speed range (minimum and maximum rpm).

Note: Bearing currents result from the action of the entire system, consisting of the frequency converter, motor, cable and earthing. IEC 60034-17 recommends taking preventive measures at shaft heights of 315 mm (approx. 132 kW) and above.

Practical aspects of output filters



Sine-wave and du/dt filters

The output filter options include sine-wave and du/dt filters. Unlike sine-wave filters, the only task of du/dt filters is to reduce the steepness of the pulse edges. They are simpler in design than sine-wave filters (smaller inductances and capacitances) and are therefore less expensive.

Sine-wave filters, which are also called motor filters or LC filters, may optionally be fitted to the outputs of frequency converters. They smooth the rectangular voltage pulses at the output to convert them into a nearly sinusoidal output voltage.

Functions and tasks of sine-wave filters

- Reducing the voltage rate of rise (du/dt) at the motor terminals
- Reducing peak voltage \hat{U}_{LL}

- Reducing motor noise
- Allowing longer motor cables to be used.
- Improving EMC characteristics
- When used with Danfoss frequency converters, sine-wave filters enable operation with unshielded motor cables in compliance with EN 61800-3 RFI category C2.

When are sine-wave filters used?

- With wet-running pumps
- With very long motor cables (including situations where this is necessary due to parallel operation)
- With well pumps
- With motors lacking good interwinding insulation
- Whenever standard motors are not used (consult motor manufacturer)

Retrofitting

If a facility operator converts older-model motors previously powered directly from the mains to speed control operation and retrofits them with a frequency converter, it is always advisable to use a sine-wave filter unless the motor datasheet indicates that the windings are designed for operation with a frequency converter. When renovations are being carried out, it is often worthwhile to replace old low-efficiency motors with new energy-efficient motors. A supplementary sine-wave filter is not necessary in such cases. The new motors usually pay for themselves very quickly due to reduced energy costs.

	du/dt filter	Sine-wave filter	Common mode filter
Motor insulation stress	Reduced – longer motor cables can be used	Reduced – longer motor cables can be used	No reduction
Motor bearing stress	Slightly reduced	Reduced circulating currents but not synchronous currents	Reduced synchronous currents
Electromagnetic compatibility	Eliminates harmonics in motor cable. No change in EMC class	Eliminates harmonics in motor cable. No change in EMC class	Reduced high-frequency emissions (above 1 MHz). No change in EMC class
Maximum motor cable length, EMC compliant	Depends on manufacturer FC 202: max. 150 m shielded	Depends on manufacturer FC 202: max. 150 m shielded or max. 300 m unshielded	Depends on manufacturer FC 202: max. 150 m shielded
Max. motor cable length, not EMC compliant	Depends on manufacturer FC 202: max. 150 m unshielded	Depends on manufacturer FC 202: max. 500 m unshielded	Depends on manufacturer FC 202: max. 300 m unshielded
Motor noise at switching frequency	No effect	Reduced	No effect
Relative size (compared to converter)	15–50% (depends on power)	100%	5–15%
Voltage drop	0.5%	4–10%	None

Practical aspects of motor cables

Rated voltage

Peak voltages up to three times the DC link voltage in the frequency converter occur in the motor cable. They severely stress the motor cable and the motor insulation. The stress is higher if the frequency converter output does not have a du/dt filter or sine-wave filter.

For this reason, the rated voltage specification of the motor cables should be at least $U_0/U = 0,6/1$ kV. High-voltage insulation testing of cables with this specification is usually performed with a test voltage of at least 3,500 V AC and usually 4,000 V AC, and in practice they have proven to have good resistance to insulation breakdown.

Cable dimensioning

The required cross-section of the motor cable depends on the output current of the frequency converter, the ambient temperature, and the type of cable installation. Overdimensioning the wire cross-section to allow for harmonics is not necessary.

For the selection and dimensioning of cables and conductors, EN 60204-1 and VDE 0113-1 provide current capacity data for wire cross-sections up to 120 mm². If larger wire cross-sections are necessary, useful information can be found in VDE 0298-4.

Motor cable length

Long motor cables are often found in water and wastewater treatment plants. Frequency converters and pumps are often installed more than 100 m apart. In such cases the voltage drop over the cable must be taken into account in cable dimensioning.

Design the system so the full output voltage reaches the motor, even with a long motor cable. The length of the motor cable that can be connected to a standard frequency converter is typically 50 to 100 metres. Even with these cable lengths, products from some manufacturers cannot provide the full output voltage at the motor.

If users need cables longer than 100 m, there are only a few manufacturers that can meet this requirement with standard products. Otherwise it is necessary to provide supplementary motor chokes or output filters.

Energy savings

The voltage drop over a motor cable, as well as the resulting heat dissipation, is nearly proportional to its length and dependent on the frequency.

Accordingly, you should keep cable runs as short as possible and dimension the wire cross-sections no larger than is electrically necessary.

Cables with suitable shielding

Shielded cables should have a shield coverage of at least 80%. Some examples of suitable cable types are:

- Lapp Ölflex 100-CY
- Helu Y-CY-JB
- Helu Topflex-EMV-UV-2YSLCYK-J

Note: Consult the manufacturer regarding the lengths of cables that may be connected to the frequency converter and the expected voltage drop.

With a standard VLT® AQUA Drive frequency converter, you can connect a shielded cable up to 150 m long or an unshielded cable up to 300 m long and still have the full voltage at the motor.

Current rating [A] of PVC cable at 40°C ambient temperature

mm ²	B1	B2	C	E
1	10,3	10,1	11,7	12,4
1,5	13,5	13,1	15,2	16,1
2	18,3	17,4	21,0	22,0
4	24,0	23,0	28,0	30,0
6	31	30,0	36,0	37,0
10	44,0	40,0	50,0	52,0
16	59,0	54,0	66,0	70,0
25	77,0	70,0	84,0	88,0

Abstract of EN 60204-1 current rating of wire cross sections

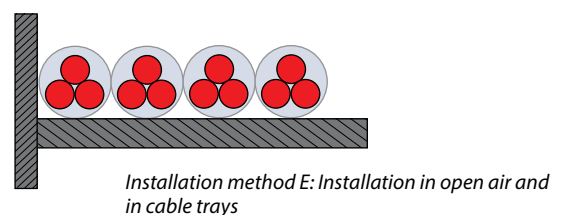
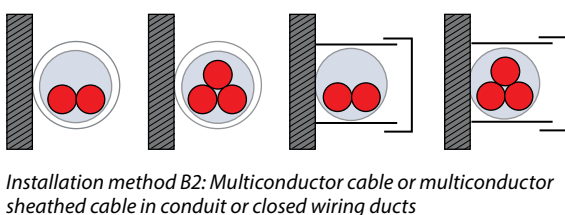
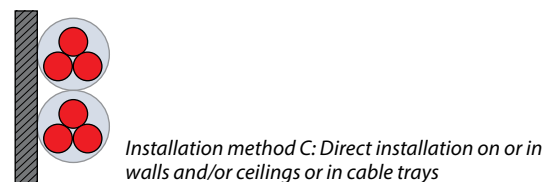
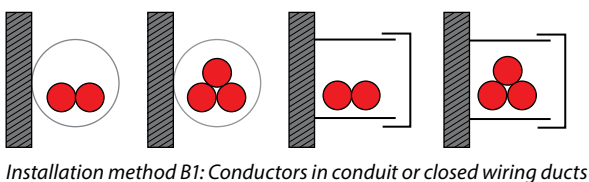

Practical aspects of earthing

The importance of earthing

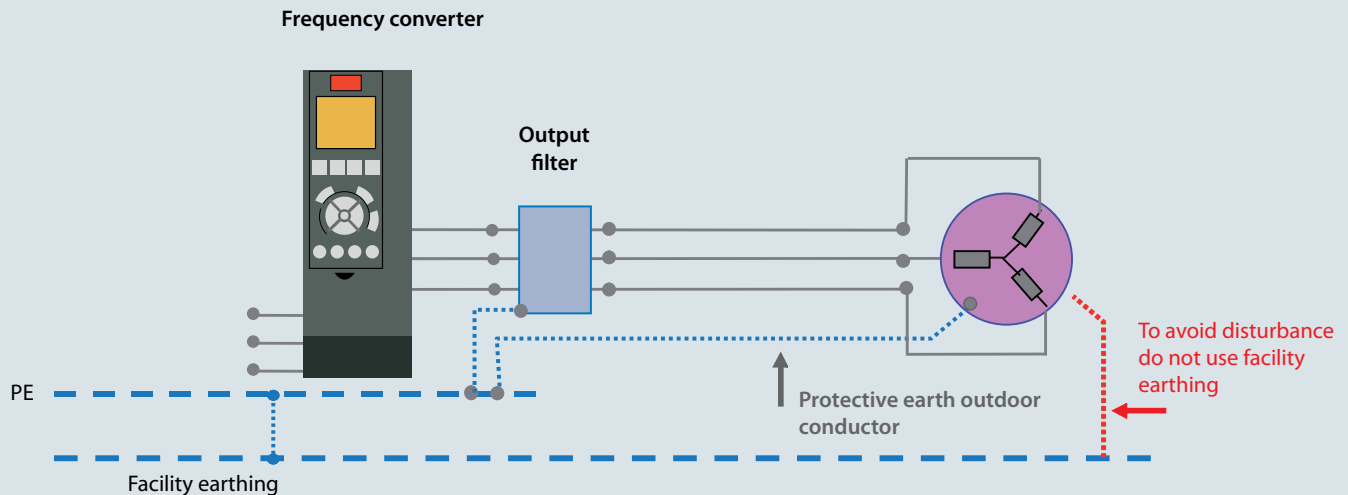

An earthing plan should always be generated for every system or facility.

Earthing measures are generally imperative in order to fulfil the statutory requirements of the EMC and Low Voltage directives. They are a prerequisite for the effective use of other measures, such as shielding and filters. Other measures are of no benefit without good earthing. For this reason, the earthing arrangements must be checked and verified for proper EMC implementation before retrofitting shielding or filters and as the first step in troubleshooting.

Electrically conductive materials

Operators must ensure that metallic surfaces are earthed with low-impedance connections. In terms of EMC, the decisive factor is not the cross-section of the conductor but instead its surface area, since high-frequency currents flow on the surface due to the skin effect. The portion with the smallest conductor surface area is what limits the ability to drain leakage currents. Earthed surfaces have a shielding effect and reduce the amplitude of ambient electromagnetic fields.

Star-configured earthing system

All earthed points and components must be connected to the central earthing point as directly as possible, such as by means of a potential equalisation rail. This results in an earthing system in which all connection points are connected radially to the earthing point. This earthing point must be defined unambiguously.

Contact points

After paint and corrosion have been removed, connections must be made to contact points using a large surface area. Serrated washers are better for this purpose than plain washers. Tin-plated, zinc-plated or cadmium-plated components should be used in preference to painted components. Multiple contacts for the shield connection must be provided in connectors.

Conductor surface area

A large conductor surface area for draining high-frequency currents can be obtained by using fine stranded

wire, such as high-flexibility instrument wire, or by using special earthing straps or cables. Braided earthing straps are often used nowadays in practice; they replace the rigid conductors used in the past. These straps have a significantly higher surface area with the same cross-section.

Note: System earthing has a substantial effect on smooth, trouble-free facility operation. Ground loops must be avoided. Good potential equalisation is essential. Generate a suitable earthing plan as early as the design and projecting engineering stage.

Practical aspects of shielding

The importance of shielding

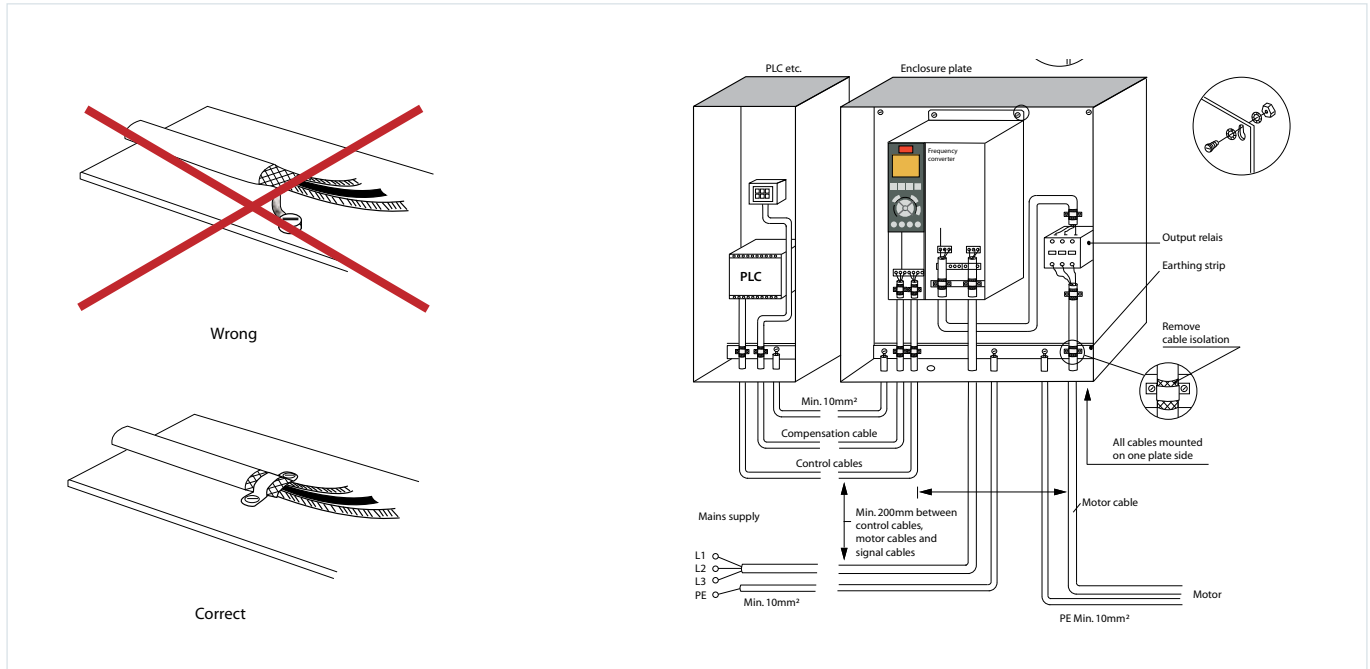

The purpose of shielding is to reduce the magnitude of radiated interference (which may affect adjacent systems or components) and to improve the interference immunity of individual devices (immunity to interference from external sources).

Implementation of shielding measures in existing systems (e.g. cable replacement or additional enclosures) is possible only at considerable expense. Manufacturers of frequency converters usually provide suitable information regarding compliance with statutory limits, which also includes information on additional measures that may be necessary, such as shielded cables.

Frequency converters generate steep-edged pulses on their outputs. These pulses contain high-frequency components (extending into the gigahertz range), which cause undesirable radiation from the motor cable. This is why shielded motor cables must be used. The task of the shield is to “capture” the high-frequency

components and conduct them back to the interference source, in this case the frequency converter.

Shielded cables and wiring

Even good shielding that complies with the limits does not fully eliminate the radiation. In the near-field region, you can expect to find electromagnetic fields that components and system modules located in this environment must be able to withstand without any degradation of their operation. Here the standard requires conformance to the limits at a specified distance (e.g. 30 dB at a distance of 10 m for Class B). With regard to the level of the allowable limit, the standard distinguishes between use in 1st environment (residential environment) and 2nd environment (industrial environment). For detailed information, see “The operating site is the decisive factor” section of this manual on page 22.

Shield connection

The cable shield must be connected all the way around to achieve effective

cable shielding. EMC (earthing) cable glands or earthing cable clamps can be used for this purpose. They fully surround the shield and connect it to ground over a large area. The shield must be routed directly to the earthing point and clamped firmly over a large area and the connection should be kept as short as possible at each end of the cable.

All other connection methods degrade the effectiveness of the shield. Users often twist the shield braid into a pigtail and use a clamping terminal to connect it to ground. This form of connection creates a high transfer impedance for high-frequency signal components, which causes interference to be radiated from the shield instead of being fed back to the source. As a result, the shielding effect may be reduced by as much as 90%.

Shield gaps

Shield gaps such as terminals, switches or contactors must be bridged by connections with the lowest possible impedance and the largest possible surface area.

Practical aspects of shielding

Ground connection

The ground connection of a shield is crucial for its effectiveness. For this reason, serrated washers or split washers must be fitted under enclosure assembly screws and painted surfaces must be scraped clean in order to obtain a low-impedance contact. Anodised aluminium enclosures, for example, provide inadequate ground bonding if plain washers are used under the fastening screws. Earth and ground leads should be made from wire with a large cross-section, or better yet from multi-cored grounding wire. If wire cross-sections less than 10 mm² are used with low-power motors, a separate PE line with a cross-section of at least 10 mm² must be run from the converter to the motor.

Motor supply cable

In order to comply with radio frequency interference limits, cables between frequency converters and motors must be shielded cables with the shield connected to the equipment **at both ends**.

Signal cable

The distance between the motor cable and the signal cable should be more than 20 cm, and the mains cable and motor cable should be routed separately as much as possible. Interference effects decrease significantly with increasing distance. Additional measures (such as divider strips) are essential with smaller separations. Otherwise interference may be coupled in or transferred. Control cable shields must be connected at both ends in the same way as motor cable shields. In practice, single-ended grounding may be considered in exceptional cases. However, it is not recommended.

Types of shields

Frequency converter manufacturers recommend using shielded cable to shield the wiring between the frequency converter and the motor. Two factors are important for selection: the shield coverage and the type of shielding.

The shield coverage, which means the amount of cable surface covered by the shield, should be at least 80%.

With regard to the shield type, a single-layer braided copper shield has proven to be extremely effective in practice. Here it is important that the shield is braided. By contrast, a wound copper wire shield (such as type NYCWY) leaves long slit-shaped areas uncovered, and HF components can easily escape through these gaps. The surface area for leakage currents is also significantly smaller.

Shielding is available in bulk for retrofitting. It can be pulled over the cable to provide the desired shielding effect. For short connections, metal hoses or pipes can be used as an alternative. Cable ducts can replace shielding only under certain conditions (a radiation-proof duct with good cover contact and a good connection between the duct components and ground).

Cables with double shielding further improve the attenuation of emitted and radiated interference. The inner shield is connected at one end, while the outer shield is connected at both ends. Twisted conductors reduce magnetic fields.

Shielded cables with twisted conductors can be used for signal lines. The attenuation of the magnetic field increases from around 30 dB with a single shield to 60 dB with a double shield and to approximately 75 dB if the conductors are also twisted.

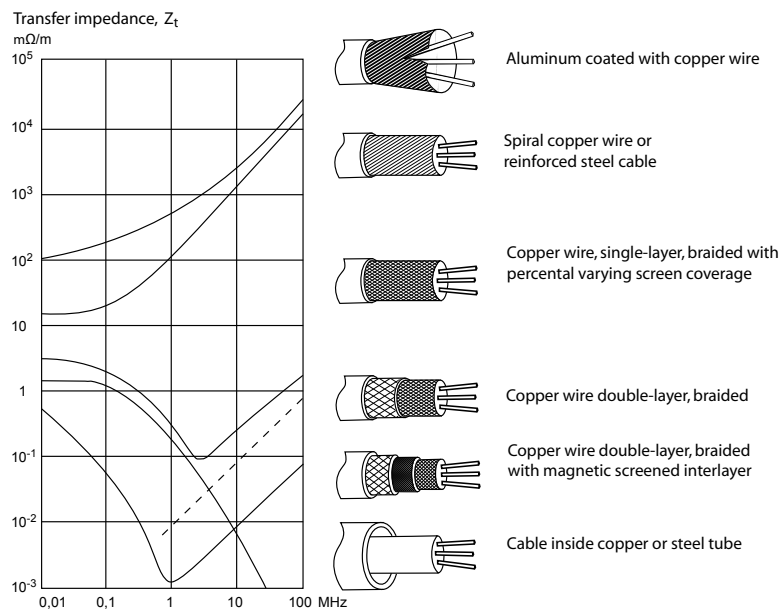

There are many types of shielded cable. Only some of them are suitable for use with frequency converters.

Step 4: Practical aspects of frequency converter selection

Basic design

In practice, designers and operators often select frequency converters solely on the basis of their rated power in kilowatts. However, frequency converters must always be selected on the basis of the actual rated motor current I_{nom} under the highest system load. This selection criterion is more reliable because motor output power depends on the mechanical shaft load instead of the electrical input power.

The motor efficiency is also not taken into account. By contrast, the rated capacity of frequency converters (in kilowatts) is based on the rated power P_{nom} of four-pole motors.

In addition, motors in the same power class may have different rated currents, depending on the motor manufacturer and the efficiency class. For example,

Remark: An 11 kW VLT® AQUA Drive frequency converter has a rated current of 24 A. This provides enough reserve power to drive a motor rated at 11 kW.

the rated current of an 11-kW motor can range from 19.8 A to 22.5 A. However, the rated current alone is not sufficient to determine the corresponding electrical input power. The frequency converter must also supply a sufficiently high motor voltage. With a 400 V mains system, this means a full 400 V at 50 Hz on the motor terminals. There are still frequency converters on the market that are not able to achieve this. The output voltage is reduced due

to voltage drops in the filters, chokes and motor cable. If the output voltage is reduced to 390 V, for example, the motor needs more current to produce the required power. As the losses increase quadratically with the current, the motor heats up more, which reduces its service life. Of course, the user must also take the increased current demand into account in the design.

Remark: A special modulation method is used in VLT® AQUA Drive units to provide the full motor voltage. Even with 10% undervoltage on the mains, the rated motor voltage and rated motor torque are maintained.

Constant or variable torque

The load driven by the motor is the key factor for selecting the right frequency converter. A distinction must be made between loads whose torque characteristic increases quadratically with increasing speed (such as centrifugal pumps and fans) and loads that can require high torque from the motor over their entire working range, even at low speeds (such as Roots blowers).

Most drive systems in water and wastewater treatment plants have a load curve that increases quadratically with speed until the rated torque is reached. In order to achieve efficiency-optimised operation under these load conditions, the frequency converter provides a motor voltage that increases quadratically with the motor rotating field frequency.

For applications with a constant high torque, in most cases it is also necessary to consider the requirement for acceleration or start-up under heavy load. In this case, the frequency converter must be able to supply extra drive power to the motor for a short time, in addition to the rated motor torque, for example to enable a pump in which sludge has collected and deposited to overcome the resulting static friction. This briefly available maximum torque is called overload torque.

In applications that do not need start-up torque significantly higher than the rated motor torque, a relatively low overload capacity is generally adequate (for example, Roots blowers with unloaded start-up require only 110% of the rated motor torque).

Note: Displacement pumps, Roots blowers and compressors are not classified as fluid flow machines. Due to their operating principle, frequency converters for use with such equipment should be designed for constant torque.

Practical aspects of load curves for various applications

Characteristic curves and applications

Constant-torque applications

Normal starting torque (110% overload)

Dosing pumps
Roots blowers
Surface ventilators
Circulation pumps
Lateral channel compressors

High starting torque [150% overload]

Axial piston compressors
Rotary piston compressors
Eccentric screw pumps (observe starting torque)
Piston pumps
Stirrers and mixers
Sludge dewatering presses
Compressors (except turbocompressors)
Displacement pumps
Gear pumps
Gearwheel rotary valves

Variable-torque applications

Centrifugal pumps
Well pumps¹
Pressure booster pumps
Filter feed pumps
Groundwater pumps¹
Hot water pumps
Heating pumps (primary and secondary circuit)
Ducted impeller pumps (solids)
Cooling water pumps (primary and secondary circuit)
Cistern pumps
Sludge recirculation pumps
Sump pumps¹
Turbocompressors
Submersed pumps¹
Surplus sludge pumps
Fans

¹Sine-wave filter recommended.

Note: Ask the pump or motor manufacturer for the torque characteristic curve.

Constant torque

Speed independent
load characteristics

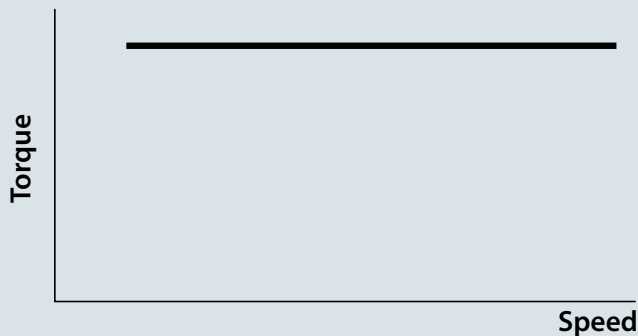

Variable torque

Speed dependent
load characteristics

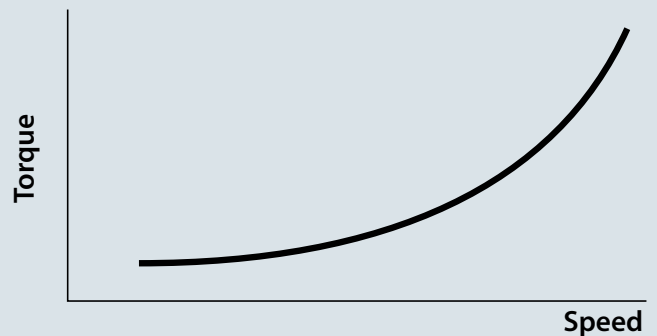

Practical aspects of multi-motor operation (special case)

Design

If the operator's objective is to run several motors in parallel from the same frequency converter, the following factors must be taken into account in the design:

The rated currents and powers of the motors must be added together.

Selection of a suitable frequency converter is based on the two sums power and current.
For motor protection, the operator must connect the PTC thermistors of the motors in series, and the frequency converter will then monitor this series-connected signal.

The connected motors operate the same in terms of their rated speed. This means that the frequency converter drives all of them at the same frequency and with the same voltage.

Note: Due to the fact that the resistances of the series-connected PTC thermistors add together, there is no point in using the thermistor monitoring capability of the frequency converter for motor protection if more than two motors are operated in parallel.



Cable routing

To be avoided with multi-motor operation: Parallel conductors cause additional capacitance. For this reason, users should always avoid this type of connection.

To be avoided

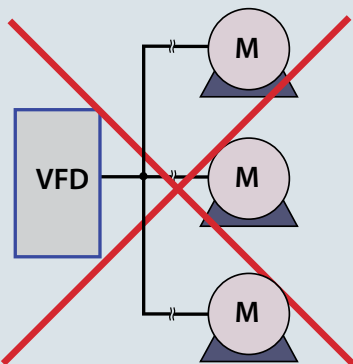

The working currents drop because the LC filter blocks the clock frequency. This allows the motors to be connected in parallel. The motor cables may also be routed together over longer distances if necessary.

Recommended

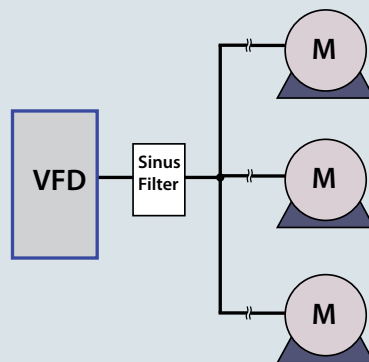

Recommended for multi-motor operation: daisy-chain the motor cable from one motor to the next.

Recommended

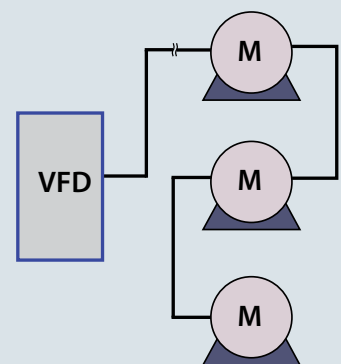

Practical aspects of EMC measures

Putting theory into practice

All frequency converters are wide-band interference sources, which means they emit interference over a wide frequency range. Facility operators can reduce the amount of interference emitted by frequency converters by taking suitable measures. For example, they can ensure trouble-free facility operation by using RFI filters and mains chokes.

With some makes, these components are already installed in the frequency converter. With other makes, the plant engineer must allow additional space (which is always at a premium) for this in the cabinet.

For general information regarding EMC, low-frequency mains interference and radio-frequency interference, see pages 13 ff of this manual.

Note: Good-quality frequency converters are equipped with good RFI protection and mains interference reduction components as standard. These components account for approximately 15 to 20% of the price of a frequency converter.

Radio frequency interference

Practical recommendations

See pages 21 ff of this manual for extensive information on radio frequency interference. The main objective in practice is to obtain systems that operate stably without interference between their components. Nevertheless, it often happens that after remodelling and/or the introduction of new components, it is no longer possible to make sensitive measurements without interference and/or the instrument signals are corrupted. These pitfalls are exactly what must be avoided. In order to achieve a high level of interference immunity, it is therefore advisable to use frequency converters with high-quality RFI filters. They should fulfil the category C1 requirements specified in the EN 61800-3 product standard and thereby conform to the Class B limits of the EN 55011 generic standard.

Additional warning notices must be placed on the frequency converter if RFI filters that do not correspond to category C1, but instead only category C2 or lower, are used. The responsibility ultimately rests with the operator. As mentioned on page 22, in case of problems the inspection authority will always base its recommendations for eliminating interference on the A1/A2 and B limits for interference defined in the EN 55011 generic standard

according to the operating environment. The operator bears the costs of remedying EMC problems. The operator is ultimately responsible for the appropriate classification of devices with respect to these two standards.

Due to the use of cables to transmit signals and power, conductive interference can easily spread to other parts of the system or facility if adequate measures are not taken. By contrast, interference radiated directly from the device or the cable is spatially confined. Its intensity decreases with every centimetre of distance away from the interference source. For this reason, installation of the converter in a suitable cabinet in compliance with EMC rules is usually sufficient to limit radiated interference. However, the system operator should always provide a suitable filter to limit conducted interference.

Two approaches to RFI filters

In practice, there are two approaches to RFI filters. Some manufacturers install RFI filters in their equipment as standard, while other manufacturers offer them as options. Built-in filters not only save a lot of space in the cabinet, but also eliminate additional costs for fitting, wiring and material. However, the most important advantage is the perfect EMC

conformance and cabling of integrated filters. Optional external RFI filters installed ahead of the frequency converter also cause an additional voltage drop. In practice, this means that the full mains voltage is not present at the frequency converter input and overdimensioning may be necessary. Costs are incurred for assembly, cabling and the material, and EMC conformance is not tested.

Another significant factor is the maximum length of the connected motor cable for which the frequency converter still complies with the EMC limits. In practice, this can range from 1 metre to 50 metres. Better RFI filters are necessary with longer cable lengths.

Note: To ensure interference-free operation of the drive system, you should always use a category C1 RFI filter.

VLT® AQUA Drive units are supplied as standard with built-in RFI filters conforming to category C1 (EN 61800-3) for use with 400 V mains systems and power ratings up to 90 kW or category C2 for power ratings of 110 to 630 kW. VLT® AQUA Drive units conform to C1 with shielded motor cables up to 50 m or C2 with shielded motor cables up to 150 m.



Mains interference

The DC link affects mains interference

See pages 15 ff for a description of the fundamental aspects of low frequency mains interference and measures to reduce it.

The increasing use of rectifier loads aggravates the occurrence of mains interference. Rectifiers draw non-sinusoidal currents from the mains. Mains interference due to frequency converters comes primarily from the capacitors in the DC link due to their charging currents. Here the current always flows in brief pulses near the peaks of the mains voltage. Due to the high current, the mains voltage sags somewhat during brief intervals and the mains voltage is no longer sinusoidal. To keep the mains power clean, it is present necessary to limit the fifth harmonic of the current to a level of approximately 40% THD. The requirements are described in the EN 61000-3-12 standard.

In application scenarios in which the operator must reduce mains interference to a THD level less than 10% or 5 %, optional filters and active measures may be used in order almost fully to attenuate mains interference from the equipment.

Reduction measures

Various options are available to facility operators in order to restrict mains interference. They can be classified into passive and active measures, and they differ in particular in terms of project engineering.

Mains chokes

The usual and least expensive way to reduce mains interference is to install chokes either in the DC link or at the input of the frequency converter. Fitting a mains choke in the frequency converter extends the duration of current flow for charging the DC link capacitors, reduces the current amplitude, and significantly reduces the distortion of the mains voltage

(lower mains interference). The degree of distortion of the mains voltage depends on the quality of the mains system (transformer impedance and line impedances). The figures in the following table can be regarded as a guideline for the connected frequency converter load (or other three-phase rectifier load) as a percentage of the rated power of the supply transformer. If the maximum value is exceeded, you should consult the frequency converter manufacturer.

In addition to reducing mains interference, mains chokes increase the life of the DC link capacitors because they are charged more gently due to the limitation of the current peaks. Mains chokes also improve the ability of the frequency converter to withstand the stress of mains transients. Wire cross sections and mains fuse or circuit breaker ratings can be smaller due to the lower input currents. However, chokes add to the cost and take up space.

Remark: A mains choke in the form of a DC link choke is integrated in all VLT® AQUA Drive frequency converters as standard. This reduces the THD from 80% to 40%, thereby fulfilling the requirement of EN 61000-3-12. The effect is therefore comparable to that of a three-phase mains choke (U_k 4%). There is no voltage drop that must be compensated by the frequency converter; the full voltage (400 V) is available to the motor.

Maximum 20% frequency converter load on transformer
in case of FCs without mains interference reduction measures, which
→ means unchoked or only lightly choked (e.g. with U_k 2%)

Maximum 40% frequency converter load on transformer
in case of FCs with mains interference reduction measures, which
→ means choked with U_k at least 4%

The above maximum load figures are recommended guideline values, which based on experience allow trouble-free facility operation.

Practical aspects of EMC measures



A low harmonic drive frequency converter is a frequency converter with a built-in active filter that acts on the mains.

Rectifiers with 12, 18, or 24 pulses per cycle

In practice, frequency converters with rectifiers having a large number of pulses per cycle are primarily found in the higher power range. They require special transformers for proper operation.

Passive filters

Passive harmonic filters, which consist of LC circuits, can be used in all situations. They have high efficiency, typically around 98.5% or better. The devices are very robust and, with the exception of cooling fans if present, usually maintenance-free. The following must be borne in mind with passive filters. If they are operated with no load, they act as capacitive reactive power sources due to the circulating current flowing in the filter. Depending on the specific application, it may be worthwhile to use a group of filters, possibly with selective connection and disconnection.

Active filters, active front ends and low harmonic drives

An innovative approach, based on improved semiconductor devices and modern microprocessor technology, is to use active electronic filter systems. They constantly measure the mains power quality and use an active current source to feed specific waveforms into the mains system. The net result is a sinusoidal current. Compared with the previously described filter options, the architecture of this new generation of filters is complex because they require fast, high-resolution data acquisition and high computing power.

It is not possible to make a basic recommendation regarding any of the mains interference reduction measures mentioned here. What is important is to make the right decisions during the design and project engineering stage in order to obtain a drive system with high

availability, low mains interference, and low radio frequency interference. In any case, the following factors must be carefully analysed before taking any decisions regarding the reduction measures to be used:

- Mains analysis
- Exact overview of the mains topology
- Space constraints in the available electrical equipment rooms
- Options for main distribution or subdistribution systems

Note: With the complex active measures there is a risk of totally missing the mark, since these measures have the serious drawback that they cause interference in the frequency range above 2 kHz (see pages 18 ff).

Practical aspects of residual current devices

AC/DC residual current protective devices

In German-speaking countries, different terms were previously used for residual current protective devices sensitive to AC only or devices sensitive to AC and DC. These devices are known internationally as residual current circuit breakers (RCCBs). The higher-level term is “residual current operated device” (RCD) as defined in EN 61008-1.

If you use equipment in a protected area that can generate a DC current in case of a fault, you must use RCDs that are sensitive to DC as well as AC current. This applies to all electrical equipment with a B6 rectifier stage (such as frequency converters) connected to a three-phase mains. This type of RCD is called a Type B RCD in accordance with IEC 60755. Due to their operating principle, frequency converters generate earth leakage currents that the plant engineer and/or operator must take

into account when selecting the fault current rating. Ask your frequency converter manufacturer what type of RCD is recommended for your application.

The RCD must be installed directly between the mains and the rectifier. Integration into a hierarchical structure with other RCDs is not permissible.

Leakage current level

The leakage current level depends on several factors. Generally speaking, leakage currents are higher in frequency converters and motors having higher power levels. A frequency converter in the 1.5 kW power range with no radio interference suppression measures and a short motor cable (around 2 m) will have a leakage current of around 4 mA. If Class B radio interference suppression is required, the leakage current with the same configuration rises to around 22 mA. A 20 kW frequency converter with Class B

radio interference suppression and a short, shielded motor cable will have a leakage current of around 70 mA. With regard to the motor cable, users can assume a current of 0.5 to 2 mA per metre of motor cable. Cabling with paired leads yields lower values than single-lead cabling.

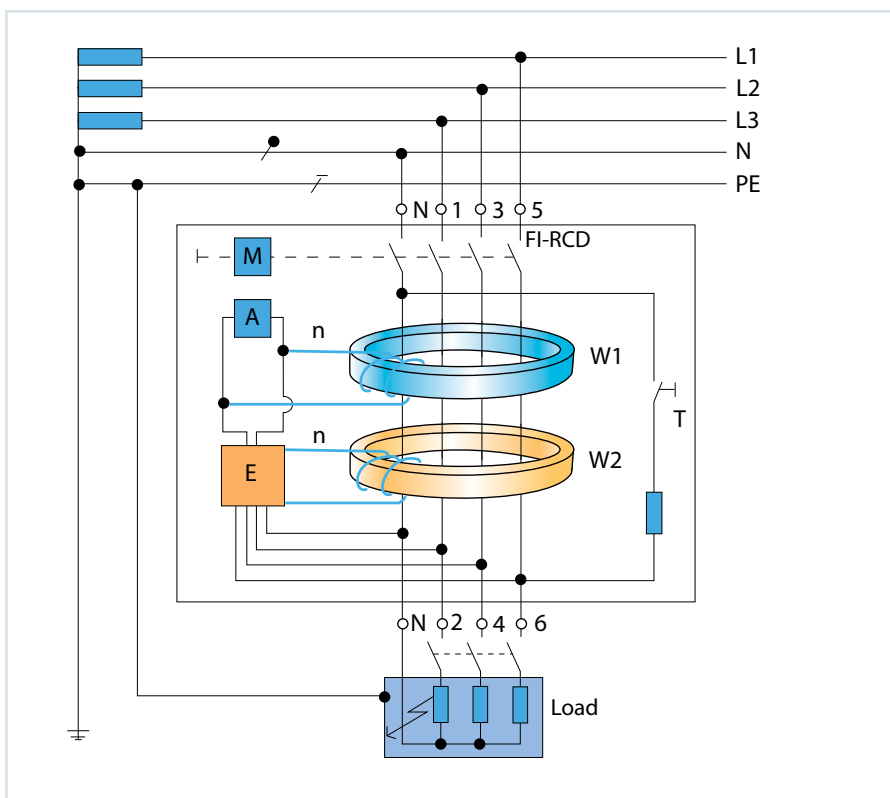

Type B RCDs have two separate monitoring circuits: one for pure DC and one for fault currents with an AC component.

Practical aspects of earthing and motor protection

Earthing measures in practice

Earthing measures are described in detail in the "Motors and cabling" section of Step 3 (pages 31 ff).

If the application requires external filters, they must be fitted as close to the frequency converter as possible. The cable between the filter and the equipment should be a shielded cable, and the filter should be connected to the earth conductor on the mains side and the equipment side. It is also recommended to mount the filter flush with the surface and provide a low-impedance connection between the filter housing and ground.

Filters generate leakage currents that can be considerably higher than the rated value in case of a fault (phase drop-out or asymmetric load). To

avoid hazardous voltages, filters must therefore be earthed before power is switched on. With leakage currents of 3.5 mA and above, in accordance with EN 50178 or EN 60335 either:

- the cross-section of the protective earth conductor must be 10 mm^2 or more;
- or the protective earth conductor must be monitored for an open circuit;
- or a second protective earth conductor must be installed in addition.

The leakage currents here are high-frequency interference signals. This requires earthing with low-impedance links bonded to a large surface area and connected to earth potential by the shortest possible route.

Note: Even the best measures to counter mains interference and radio frequency interference are of no use if their implementation in the installation does not conform to good EMC practice. Interference problems are inevitable in such cases.

Motor protection and motor PTC thermistor

Frequency converters assume the task of protecting the motor against excessive current. Thermistor sensors or thermal cutouts in the motor winding are used to provide the best possible motor protection. The signal is monitored via suitable input terminals on the frequency converter. Thermistors compliant with DIN 44081 or DIN 44082 are designed to have a resistance within a certain range at the rated response temperature (RRT) ($RRT - 5^\circ\text{C} < 550 \Omega$; $RRT + 5^\circ\text{C} > 1330 \Omega$). Many converters have functions suitable for monitoring such thermistors. In the case of motors operated in explosion hazard areas, thermistor monitoring is allowed only with certified trip devices (see page 30).

The protective function of motor protection switches is limited to direct

mains operation. In electrical systems with frequency converters, they can only provide motor protection in an emergency situation when the frequency converter is bypassed by a suitable circuit. The motor protection function of the switch is ineffective with frequency converter operation. Nevertheless, with proper dimensioning it can be put to good use with converter-driven motors as a sort of three-phase circuit breaker that only protects the wiring.

Remark: Many frequency converters have a supplementary function called „thermal motor image“. The motor temperature is calculated from the motor data and the amount of power transferred to the motor. This function is usually implemented very conservatively and tends to trigger earlier than absolutely necessary. The actual ambient temperature at the start of the calculation process is usually not taken into account. However, this function can be used to provide a simple form of basic protection if no other form of motor protection is available.

Note: With VLT® AQUA Drive, terminals 50 and 54 are normally designated for connecting thermistors. This port is suitable for motor temperature monitoring using three to six PTC bead thermistors (standard configuration: three beads per motor).

Practical aspects of operator control and data display

Simple operating concept

The basic technology of all frequency converters is the same, so ease of use is a decisive factor. Many functions, as well as integration in machines or systems, require a simple operating concept. It must fulfil all requirements for easy and reliable configuration and installation.

The options range from simple and inexpensive numerical displays to convenient control panels that display data in text form. Simple control panels are adequate for the basic task of observing operating parameters such as current or voltage.

By contrast, control panels with convenience features allow the display to show additional parameters or present them all at the same time. Clear grouping of functions and easy manual operation are also possible, as well as options for access via software,

a field bus, or even remote maintenance using a modem or the Internet. A modern frequency converter should be able to combine all of the operating concepts mentioned below in a single device or to make them possible and it should at least allow switching between manual and remote control at all times.



design award winner

This control panel won the international iF Design Award for user friendliness in 2004. The LCP 102 was selected for this distinction from among 1000 entries from 34 countries in the category "man-machine and communication interfaces".



Graphic control panels offer ease of use and can display information in plain text.



Easy commissioning
Features such as Danfoss Smart Start considerably simplify the commissioning of converters. It guides the user through the basic converter settings.



Practical aspects of operator control and data display

Operation under local control

The basic requirement is support for local operation using a local control panel. Even in the era of networked communication, there are many tasks that require the ability to control the equipment directly – such as commissioning, testing, process optimisation and on-site maintenance activities in facilities.

In each of these cases, the operator or technician may need to be able to alter local values in order to incorporate the changes in the system directly and perform related tasks, such as fault diagnosis. For this purpose, the control panel should provide a simple and intuitive man-machine interface.

Clear display

The ideal solution is a graphic display, since it allows the user to select the preferred language for the user interface and the basic display mode can show the essential parameters of the actual application.

To maintain clarity, this status information must be limited to the essential parameters and it must be possible to adapt or change the parameters at all times. It is also helpful to be able to block or hide certain functions according to the knowledge level of the operator and to limit parameter display and the ability to modify parameters to what is actually necessary for process adjustment and control.

With the large number of functions provided by modern frequency converters, which often have several hundred parameters for optimal adaptation, this reduces operator errors and thereby reduces expensive downtime and facility outages. Likewise, the display should have an integrated help function for the individual functions so that support is available to the commissioning technician or service technician at all

times, especially for rarely used parameters, in order to eliminate operator errors as much as possible here as well.

For the optimal use of integrated diagnostic functions, it is very helpful to be able to display graphic plots (“scope function”) in addition to alphanumeric data. In many cases this form of data display, such as ramp shapes and/or torque curves, makes troubleshooting easier.

Uniform concept

In water and wastewater treatment plants, a large number of frequency converters are used in a wide variety of applications. The converters, which usually are mostly from the same manufacturer, differ primarily in their power ratings and therefore in their size and appearance. A uniform operator interface for the frequency converters, with the same control panel over the entire power range, offers advantages for plant engineers and facility operators.

The basic principle is that simplifying the operator interface makes commissioning and troubleshooting (if necessary) faster and more effective. Consequently, concepts based on plug-and-play control panels have proven their value in practice.

Integrated in the cabinet door

In many facilities in which frequency converters are installed in cabinets, facility engineers should integrate the control panels in the cabinet doors to provide process visualisation. This is only possible with frequency converters that have detachable control panels. With the control panel integrated in the cabinet door using a mounting frame, the frequency converter can be controlled without opening the cabinet door and its operating state and process data can be read out.

***Note:** Ensure that the frequency converter you plan to engineer into the system has the right operating concept. A design that provides the greatest possible ease of use for parameter configuration and programming is an advantage, since nowadays the functionality of the drive is not the only significant factor. Fast, easy user operation, preferably intuitive, is also important. This is the only way to reduce the effort, and thus the cost of familiarisation and the subsequent interaction times of employees responsible for working with frequency converters.*

Frequency converter parameters can also be configured and read out with the cabinet door closed.



Practical aspects of control and parameter configuration with a PC

Extended options

In addition to operation using a control panel, modern frequency converters usually support parameter configuration and data readout by a PC program. This software usually runs under Windows and supports several communication interfaces. It enables data exchange over a traditional RS 485 interface, a field bus (Profibus DPV1, Ethernet, etc.) or a USB interface.

A clearly structured user interface provides a quick overview of all the drives in a system. A good program also allows users to manage large systems with many drives. Parameter configuration is possible online and offline. Ideally, the program also allows documents to be integrated into the system. Among other things, this makes it possible to access system electrical diagrams or operating manuals from the program.

Remark: The MCT 10 program is a Windows-based engineering tool for easy system engineering, parameter configuration and programming of VLT® AQUA Drive units.

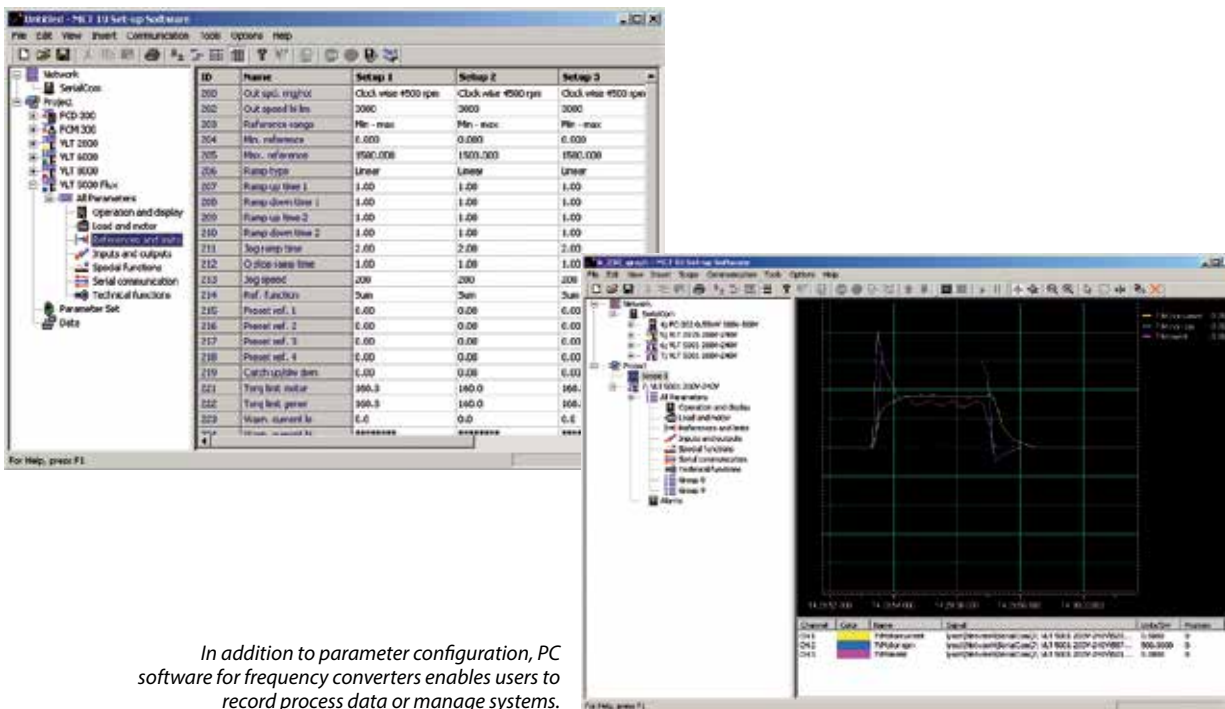

In addition to parameter configuration, PC software for frequency converters enables users to record process data or manage systems.



Practical aspects of data exchange

Bus systems

Modern frequency converters are intelligent, which enables them to handle many tasks in drive systems. Nevertheless, even now many devices operate with only four data points in a control system or under control of a PLC and act only as speed controllers. This means that operators do not make full use of the many useful functions and do not have access to stored system data. However, it is easy for users to exploit the full potential of frequency converters by using a field bus link, such as Profibus, to integrate them in the control system. With just one hardware data point, this gives users full access to all parameters of the installed frequency converters. Cabling and commissioning are simpler, which leads to cost savings from the installation phase onward. A large volume of data for effective facility management is available. Decoding of collective fault messages allows faults to be diagnosed, even remotely and the right fault correction actions to be initiated.

Better alarm management

Detailed alarm messages simplify the pin-pointing of possible fault causes and thereby provide effective support

for remote facility monitoring. Remote maintenance using modems or the Internet allows state and/or fault messages to be displayed quickly, even with remote systems or system components.

Better facility management

The control room operator is able to monitor and adjust all frequency converter settings remotely. Status data, such as the output frequency or power consumption, can be read out and processed at any time. Additional data for effective energy and peak load management is available without additional components.

Lower installation costs

It is not necessary to equip every frequency converter with a display. The user or operator can access all relevant frequency converter data via the control system. Simplified wiring with two-wire connections. Unused frequency converter inputs and outputs can be used as I/O ports to integrate other components, such as sensors, filters and limit switches, into the control system. No need for input and output components, since a single hardware data

point is sufficient for controlling the frequency converter. Monitoring functions such as motor thermistor monitoring, dry pump protection, etc., as well as output and operating hours counters, are available without additional components.

Simplified commissioning

Parameter configuration is performed from the control room. All settings can be copied quickly and easily from one frequency converter to another. A persistent backup copy of the settings can be stored in the display memory. Designers and commissioning staff can document the settings at the press of a button.

Remark: The RGO 100 Remote Guardian Option sets new standards for monitoring, maintenance and alarm processing for frequency converters in one or more facilities. It supports typical tasks such as remote action, remote maintenance, alarm processing and data logging for system configuration and system monitoring.



Practical aspects of additional selection factors

Process controller

Modern frequency converters are intelligent drive controllers. They can perform tasks and functions traditionally handled by PLCs. The implemented process controllers can also be used to build independent high-pre-

cision control loops. This facility is especially useful when retrofitting systems with insufficient PLC capacity or no PLC at all. Active process parameter transducers (actual value transmitters for flow,

pressure or level) can be powered from the frequency converter's 24 V DC control voltage if it has sufficient power capacity.

Maintenance

Most frequency converters are virtually maintenance-free. High-power frequency converters have built-in filter mats which must be cleaned from time to time by the operator, depending on the dust exposure.

However, it must be noted that frequency converter manufacturers specify maintenance intervals for the cooling fans (approximately 3 years) and capacitors (approximately 5 years) in their equipment.

Remark: Danfoss VLT® frequency converter models up to 90 kW are maintenance-free. Models rated at 110 kW or more have filter mats integrated in the cooling fans. They must be checked periodically and cleaned as necessary.

Storage

Like all electronic equipment, frequency converters must be stored in a dry place. The manufacturer's specifications in this regard must be observed. Some manufacturers specify that the device must be formed periodically. For this purpose, the user must connect the device to a

defined voltage for a certain period. This forming is necessary due to the aging of the capacitors in the device's DC link. The aging rate depends on the quality of the capacitors used in the device. Forming counters the aging process.

Remark: Due to the quality of the capacitors used and the flexible, order-specific manufacturing concept, this procedure is not necessary with VLT® AQUA Drive frequency converters.

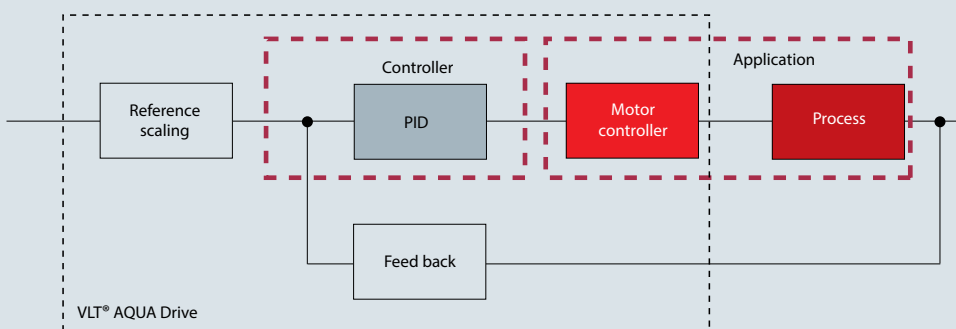

PID process controller block diagram



VLT® AQUA Drive



VLT® AQUA Drive units are available with power ratings from 0.37 kW to 1.4 MW and a rated voltage of 400 V or 690 V. VLT® Low Harmonic Drive versions are also available for reduced mains interference.

Danfoss® AQUA Drives are specifically designed for use in water and wastewater treatment applications. Unlike many other makes, all important components and functions are integrated as standard.

- Full mains voltage at the output
- Long motor cables may be connected (150 m shielded or 300 m unshielded)
- Dimensioned for long service life
- Built-in RFI filter compliant with EN 61800-3 category C1 (Class B limits as defined by EN 55011)
- Built-in mains interference chokes (UK 4%)
- PTC thermistor monitoring
- AEO function for especially high energy savings
- Thermal motor image integrated in the frequency converter as software

motor protection, which also takes into account low internal motor ventilation at low speeds (not possible with motor protection switches)

- RS 485 serial interface
- USB interface
- Real time clock
- Dry pump protection
- Outlet flow monitoring
- Running-time controlled pump alternation
- Wear-reducing pump start-up
- Pipe-filling function to avoid water hammer effects
- Optional integrated Profibus port (also with an external 24 V DC power supply)
- Integrated cascade controller for three pumps
- Optional basic or advanced cascade controller
- Optional sensorless pump control

- Optional active and passive mains filters for additional harmonic reduction
- Optional sine-wave filter and du/dt filter for all power ratings
- VLT® AQUA Drive in low harmonic version

Extensive information is available from your Danfoss contact person or the Web. A considerable amount of information is available for downloading on the website.

www.danfoss.com/vlt

Directives related to frequency converters

CE mark

The CE (Communauté européenne) mark is intended to eliminate technical barriers to free trade between the EC and EFTA states (inside the ECU). The CE mark indicates that the product manufacturer conforms to all applica-

ble EC directives which have been transposed into national law. The CE mark says nothing about the quality of the product. Technical specifications cannot be deduced from the CE mark. The directives that must be observed

within the scope of use of frequency converters include the Machinery Directive, the EMC Directive, and the Low-Voltage Directive.

Machinery Directive

Application of the Machinery Directive 2006/42/EC became mandatory on 29 December 2009. Machinery Directive 98/37/EC was thereby abrogated. The key message of the directive is that a machine, consisting of an aggregate of interconnected components or devices of which at

least one is able to move, must be fashioned such that the safety and health of people and as appropriate, domestic animals or goods are not endangered as long as the machine is correctly installed, suitably maintained and used as intended. Frequency converters are classified as electronic components and are

therefore not subject to the Machinery Directive. When plant engineering firms use frequency converters in machines, they generate a manufacturer's declaration stating that the machine conforms to all relevant statutes and security measures.

EMC Directive

The EMC Directive 2004/108/EC has been in force since 20 July 2007. Its key message is that devices that are liable to generate electromagnetic interference or whose operation can be adversely affected by such interference must be fashioned such that the generation of electromagnetic interference is limited, insofar as radio

and telecommunication devices as well as other devices exhibit a suitable degree of immunity to electromagnetic interference when operated according to their intended use, such that operation according to the intended use is possible. As frequency converters are not devices that can be operated independently and are not

generally available, it is not necessary to document conformity to the EMC Directive by means of a CE mark or an EC declaration of conformity. Nevertheless, Danfoss frequency converters have the CE mark as an indication of conformity to the EMC Directive, and a declaration of conformity is available.

Low-Voltage Directive

The Low-Voltage Directive 73/23/EEC took force on 11 June 1979; the transition period ended on 31 December 1996. The key message is that electrical equipment for use with a nominal voltage of 50 to 1000 V AC or 75 to 1600 V DC must be fashioned such that the safety and health of people and livestock and the preservation of material worth are not

endangered as long as the equipment is properly installed and maintained and used as intended. As frequency converters are electrical equipment operating in the specified voltage range, they are subject to the Low-Voltage Directive and all devices produced from 1 January 1997 onward must bear a CE mark.

Note: Manufacturers of machines or systems should ensure that the frequency converters they use bear the CE mark. An EC declaration of conformity must be provided on request.

Index

A			
Active filters	17, 18, 20, 46	Cost factor	10
Active front end	17, 19, 20, 46	Coupling mechanism	14
Aggressive atmosphere/ gases	28	Current consumption	15
Air conditioning	27	Current spectrum	
Air flow	27, 29	D	
Ambient temperature	27	Data display	49, 50
Ammonia	28	Data exchange	51
Amplitude	15	DC link	17, 19, 23, 27, 45
Apparent power	16	DC link voltage	34, 37
Asymmetric load	24	DC voltage	17, 20
ATEX	30	Decommissioning costs	10
Automatic energy optimisation (AEO)	9, 54	Design checklist	6, 62
Availability	8, 16	Directives	15, 55
B		Disposal costs	10
Backup power systems	24	Distortion	15
Bearing current	35	Distortion spectrum	18
Bearing stress	35	Downtime costs	10
Bus system	52	Drive system	8
C		Dust exposure	29
Cabinet heating	27	dU/dt filter	20, 35, 36, 37
Cabinet mounting (central mounting)	25	E	
Cable glands (regular and EMC)	39	Earthing	38, 48
Capacitive coupling	14	Earthed neutral conductor	12
Capacitor	17	EC motors	33, 34
Capacity increase	8	Efficiency classes	31, 41
CE mark	55	Electromagnetic waves	14
Central compensation	18	Emax control	8
Characteristic curves	15	EMC cable glands	37
Chlorine	28	EMC characteristics	12
Chokes	17, 23, 24, 37, 45	EMC Directive	55
Climatic conditions	27	EMC	12, 13, 14, 21, 25, 38, 44
Common mode filter	36	Energy costs	10
Coated PCBs	28	Energy efficiency	7
Commissioning costs	10	Energy network	15
Compensation current	18	Energy savings	8
Condensation	27	Environment (1 or 2)	21, 22, 23, 24, 39
Conductive coupling	14	Environmental conditions	7, 25
Conductor	37, 38, 43	Environmental costs	10
Configuration	51	Explosion protection (ATEX)	30
Connected load	8	F	
Connection conditions	15	Facility earthing	38
Constant characteristic curve	41, 42	Facility operator	15
Contact points	38	Facility services designer	7
Contamination	28	Filter mats	29
Control loop	53	Flow	8
Control panel	49, 50	Fluid flow machines	9, 41
Control range	8	Fourier analysis	15
Control room	27	Full load	8
Cooling	27, 29		
Corrosion	28		
Cos φ	23		

G		M	
Generator	24	Machinery Directive	55
Generic standard	21	Magnetic field	14
Ground connection	38	Mains analysis	16, 24
Ground loop	38	Mains calculation	16, 46
Group compensation	18	Mains chokes	44, 45
H		Mains filter	21
Harmonic calculation	16, 24	Mains fuse/ circuit breaker	44
Harmonic current	16, 18	Mains impedance	24
Harmonic distortion	15, 17, 18	Mains interference	15, 16-20, 44
Harmonic filter	16, 17, 42, 43	Mains power quality	15, 16, 17
Harmonic load	24	Mains system	8, 12, 15, 23
Harmonics	14	Mains transients	17, 23, 24
Heat loss/dissipation	27, 35	Mains type	12
Heat sink	29	Maintenance costs	7, 10
Hydrogen fluoride	28	Maintenance	53
Hydrogen sulphide	28	Material wear	8
I		Minimum efficiency performance standards (MEPS)	31, 32
IE classes	31	Motor bearing	33, 36
IEC enclosures	32	Motor cable	35, 36, 37, 39, 40
Ignition protection class	30	Motor efficiency	31
Individual compensation	18	Motor insulation	36, 37
Individual earthing	12	Mounting clearance	27
Inductive coupling	14	Multi-motor operation	41
Industrial environment	22, 24	N	
Industrial mains	15	Neutral conductor, separate/ combined	12
Initial capital costs	10	Nitrogen	28
Input rectifier	15	Nonlinear characteristic	42
Installation conditions	25	Non-sinusoidal currents	15
Installation costs	10	O	
Insulation stress	33	Operating costs	8, 10
Interference emission	13	Operating point	8
Interference fields	14	Operating site (EMC)	21, 22, 25
Interference immunity	13, 2	Output Filter	36, 37, 38
Interference level	21	Overall system	8
Interference sink	14	Overload capacity	41
Interference source	14	Oversynchronous range	8
Interference transmission	12	Ozone	28
IP ratings	26	P	
IT mains system	12	Panel mounting kit	50
L		Parallel operation	41
LC filter, circuits	34, 46	Partial-load operation	8, 9
Leakage current	47, 48	Passive filters	17, 20, 46
Life cycle costs (LCC)	7, 10	Payback time	8
Lightning strikes	3	Peak currents	8
Linear characteristic	41, 42	Permanent magnet motors (PM/ PMSM)	33, 34
Load asymmetry	24	Phase shift	23
Load characteristic	42	Piping system	8
Load shock	8	PLC	53
Low Harmonic Drive (LHD)	17, 19, 46	Potential energy savings	8, 9
Low-Voltage Directive	55	Power consumption	9
Low-voltage grid	24		

Index

Power factor	17, 19, 23		
Pressure	8		
Process controller	53		
Product standard	21		
Project engineering	7		
Proportionality rules	9		
Protection ratings	25, 26		
Protective earth conductor	12		
Provision costs	8		
PTB approval	30		
PTC thermistor	30, 43, 48, 54		
Public power grid	15		
Pump systems	10		
Q			
Quality	7		
R			
Radiation coupling	14		
Radiation	39		
Radio frequency interference	21, 22, 44		
Rated motor current	8, 41		
RCD	47		
Reactive current	9, 35		
Reactive power	24		
Rectifier	15, 17, 24, 46		
Reduction/Derating	13, 42		
Relative humidity	27		
Repair costs	8		
Residential environment	22, 24		
Residual current device	47		
Resonances	24		
Retrofit	8, 36		
RFI filter	21, 42		
RFI	21, 36, 44		
RMS value	16		
Run time, pump	10		
S			
Screening measures	39		
Second-level protection	21		
Service life	8, 27, 29, 42		
Shielding	39		
Short circuit	21		
Sine-wave distortion	15		
Sine-wave filter	30, 36		
Sinusoidal voltage	15		
Special environment	22		
Staggered windings	24		
Starting current limiting	8		
T			
THD (total harmonic distortion)	15, 17, 18, 20, 45		
Thermal stress	35		
Three- phase induction motors (TPIM)	33		
Throttle valve	9, 10		
TN mains systems	12		
Torque characteristic	8, 41, 42		
Transformer (load, utilisation)	24, 45		
Transients	18, 23, 24, 41		
TT mains system	12		
U			
Undervoltage losses	16		
V			
V/f characteristic	9		
Valve control	10		
Varistor	23		
Voltage drop	36, 37, 41		
Voltage sags	8		
Volumetric flow	10		
W			
Wall mounting (local)	25		
Wavelength	14		
Winding	35		

Abbreviations

AFE	Active Front End
AHF	Advanced Harmonic Filters
ATEX	Atmosphère explosible
CE	Communauté Européenne
CEMEP	European Committee of Manufacturers of Electrical Machines and Power Electronics
DC	Duty Cycle
Eff	Efficiency classes (motors)
EMD	Electromagnetic discharge
EMC	Electromagnetic compatibility
EN	European Norm (standard)
FC	Frequency converter
IE	International Efficiency (motors)
IEC	International Electrotechnical Commission
IP ratings	Ingress Protection ratings
LCC	Life Cycle Cost
LHD	Low Harmonic Drive
MEPS	Minimum Efficiency Performance Standards
PCB	Printed Circuit Board
PFC	Power Factor Correction
PLC	Programmable Logic Controller
PTB	Physikalisch - Technische Bundesanstalt
PTC	Positive Temperature Coefficient
RCCB	Residual Current Circuit Breaker
RCD	Residual Current Device
RFI	Radio Frequency Interference
THD	Total Harmonic Distortion



Frequency Converter Design Checklist

The four steps of basic frequency converter design for an operationally reliable water treatment or wastewater treatment plant

Starting after the determination of the drive task and torque characteristics

If you verify all items in this checklist, you can confidently look forward to trouble-free facility operation.



Mains systems

<input type="checkbox"/>	Mains type: TN-C, TN-S, TT, IT	TN-S is favourable with regard to EMC. Special measures are necessary with IT mains systems.
<input type="checkbox"/>	EMC	Observe the EMC standards and their limits.
<input type="checkbox"/>	Mains interference (low frequency)	How much mains interference is already present? What is the maximum allowable harmonic current (THD)?
<input type="checkbox"/>	Radio frequency interference (high frequency)	What is the environment class (1 or 2) of the facility?
<input type="checkbox"/>	Power factor correction equipment	Fit power factor correction equipment with chokes.
<input type="checkbox"/>	Mains transients	Are the FCs adequately protected against main transients?
<input type="checkbox"/>	Max. transformer utilisation	Rule of thumb for transformer load: approximately 40% FC load (with choke).
<input type="checkbox"/>	Operation with a standby generator	Other conditions apply to the FC here than with mains operation.



Ambient conditions

<input type="checkbox"/>	Installation location	FC mounted centrally in a cabinet (IP20) or locally on the wall (IP54 or IP66)?
<input type="checkbox"/>	Cooling concept	Cooling of cabinet and FC; high temperatures damage all types of electronic components.
<input type="checkbox"/>	Aggressive atmosphere/gases	Coated PCBs for protection against aggressive gases: hydrogen sulphide (H ₂ S), chlorine (Cl ₂) and ammonia (NH ₃).
<input type="checkbox"/>	Dust exposure	Dust on or in the FC reduces cooling effectiveness.
<input type="checkbox"/>	Potentially explosive atmospheres	Here FCs are subject to restrictions.





Motor and cabling

<input type="checkbox"/>	Motor efficiency classes	Selecting an energy-efficient motor
<input type="checkbox"/>	Motor suitability for FC operation	Ask the motor supplier to confirm suitability for FC operation.
<input type="checkbox"/>	Output filter: sine-wave or du/dt	Supplementary filters for special applications.
<input type="checkbox"/>	Motor cable	Use a cable with suitable shielding. Observe the maximum connected cable length specification of the FC.
<input type="checkbox"/>	Earthing measures	Ensure proper potential equalisation. Is an earthing plan available?
<input type="checkbox"/>	Shielding measures	Use EMC cable glands and terminate the shield correctly.



Frequency converter

<input type="checkbox"/>	Dimensioning and selection	Dimension according to motor current. Take voltage drops into account.
<input type="checkbox"/>	Special case Multi-motor operation	Special conditions apply here.
<input type="checkbox"/>	Radio frequency interference (high frequency)	Specify suitable RFI filters for the actual EMC environment.
<input type="checkbox"/>	Mains interference (low frequency)	Use mains interference chokes to reduce harmonic currents.
<input type="checkbox"/>	Earthing measures	Have measures to counter leakage currents been taken?
<input type="checkbox"/>	RCDs	Use only type B RCDs.
<input type="checkbox"/>	Motor protection and motor PTC thermistor	The FC monitors the motor PTC thermistor. (EX zone PTB approval)
<input type="checkbox"/>	Operator control and data display	Operator control and data display using a text display (installed in the cabinet door).
<input type="checkbox"/>	Data exchange (bus systems)	Over bus systems (e.g. Profibus) or over conventional wiring between terminals.
<input type="checkbox"/>	Process controller	FCs can perform PLC tasks or establish autonomous control loops.
<input type="checkbox"/>	Maintenance	Is the frequency converter maintenance-free?

What VLT® is all about

Danfoss VLT Drives is the world leader among dedicated drives providers – and still gaining market share.

Environmentally responsible

VLT® products are manufactured with respect for the safety and well-being of people and the environment.

All activities are planned and performed taking into account the individual employee, the work environment and the external environment. Production takes place with a minimum of noise, smoke or other pollution and environmentally safe disposal of the products is pre-prepared.

UN Global Compact

Danfoss has signed the UN Global Compact on social and environmental responsibility and our companies act responsibly towards local societies.

EU Directives

All factories are certified according to ISO 14001 standard. All products fulfil the EU Directives for General Product Safety and the Machinery directive. Danfoss VLT Drives is, in all product series, implementing the EU Directive concerning Hazardous Substances in Electrical and Electrical Equipment (RoHS) and is designing all new product series according to the EU Directive on Waste Electrical and Electronic Equipment (WEEE).

Impact on energy savings

One year's energy savings from our annual production of VLT® drives will save the energy equivalent to the energy production from a major power plant. Better process control at the same time improves product quality and reduces waste and wear on equipment.

Dedicated to drives

Dedication has been a key word since 1968, when Danfoss introduced the world's first mass produced variable speed drive for AC motors – and named it VLT®.

Twenty five hundred employees develop, manufacture, sell and service drives and soft starters in more than one hundred countries, focused only on drives and soft starters.

Intelligent and innovative

Developers at Danfoss VLT Drives have fully adopted modular principles in development as well as design, production and configuration.

Tomorrow's features are developed in parallel using dedicated technology platforms. This allows the development of all elements to take place in parallel, at the same time reducing time to market and ensuring that customers always enjoy the benefits of the latest features.

Rely on the experts

We take responsibility for every element of our products. The fact that we develop and produce our own features, hardware, software, power modules, printed circuit boards, and accessories is your guarantee of reliable products.

Local backup – globally

VLT® motor controllers are operating in applications all over the world and Danfoss VLT Drives' experts located in more than 100 countries are ready to support our customers with application advice and service wherever they may be.

Danfoss VLT Drives experts don't stop until the customer's drive challenges are solved.

