

ENGINEERING  
TOMORROW



Selection Guide 0.25 kW – 1.4 MW

# VLT® AQUA Drive FC 202 series for a Masterclass Performance



**30%**

cost saving in the  
first year, compared  
to traditional drive  
systems

[drives.danfoss.com](http://drives.danfoss.com)

**VLT**®

# Contents

The VLT® AQUA Drive – a masterclass performance in cost efficiency and trouble-free operation .....	4
Installation savings .....	6
Installed efficiency	
Additional energy savings: up to 15% of your drive investment each year .....	8
Trouble-free operation.....	10
In a class of its own: the most comprehensive program to cover all your applications.....	12
Back-channel cooling:	
Efficient and economic heat management .....	14
Harmonic mitigation:	
Invest less and save more! .....	16
Harmonic mitigation solutions.....	18
Cost effective mitigation.....	20
Unique cascade controller, based on Hot Swap technology.....	22
A master of all motor technologies .....	24
Save commissioning time with SmartStart.....	25
Customize and be your own master.....	26
Flexible, modular and adaptable.....	27
Modular simplicity – A, B and C enclosures.....	28
Extended functionality for high-performance operation – Enclosed Drives .....	30
Dedicated water and pump features.....	32
Wireless connectivity to the drive .....	36
Support common fieldbuses.....	36
A masterpiece of innovation turns energy consumption into energy production.....	37
DrivePro® Life Cycle services.....	38

## Specifications, options and ordering

Connection example .....	40
VLT® AQUA Drive technical data .....	41
Enclosure overview A, B and C.....	42
Electrical data – A, B and C enclosures .....	43
Dimensions enclosure sizes A, B and C.....	48
Ordering typecode for A, B and C enclosures.....	49
Enclosure overview D, E and F .....	50
Electrical data – D, E and F enclosures.....	51
Dimensions enclosure sizes D, E and F .....	55
Electrical data VLT® 12-Pulse.....	56
Dimensions VLT® 12-Pulse.....	57
Ordering typecode for D, E and F enclosures .....	58
Electrical data Enclosed Drives.....	60
Dimensions Enclosed Drives.....	63
Ordering typecode for Enclosed Drive enclosures.....	64
Electrical data – VLT® Low Harmonic Drive and VLT® Advanced Active Filters .....	66
Dimensions – VLT® Low Harmonic Drive and VLT® Advanced Active Filter .....	67
Typecode VLT® Advanced Active Filter.....	67
A options: Fieldbuses.....	68
B options: Functional extensions .....	69
C options: Cascade controller and relay card .....	70
D option: 24 V back-up power supply.....	70
Power options .....	72
Accessories .....	73
Accessory compatibility with enclosure size .....	74
Loose kits for enclosure sizes D, E and F .....	76



**INSTALLATION SAVINGS**



**INSTALLED  
EFFICIENCY**



**VLT**®



**TROUBLE-FREE  
OPERATION**

# The VLT® AQUA Drive – a **masterclass performance** in **cost efficiency** and **trouble-free operation**

As the first to produce dedicated drives for the water and wastewater industry, Danfoss is a frontrunner in the development of drives that address the specific needs and challenges of water facilities, and Danfoss is the most popular choice of supplier for drives solutions to the global water industry.

The VLT® AQUA Drive combines deep application know-how with powerful drives technology to make your water operation easier and more efficient than ever, while saving you considerable installation and running costs.

Built to last and withstand even the harshest conditions, the VLT® AQUA Drive offers trouble-free operation of any type of water facility anywhere in the world. The combination of solid design and sophisticated software-based solutions ensure considerable energy savings and help you achieve a masterclass standard of sustainable and economic water management.



WATCH THE ANIMATION





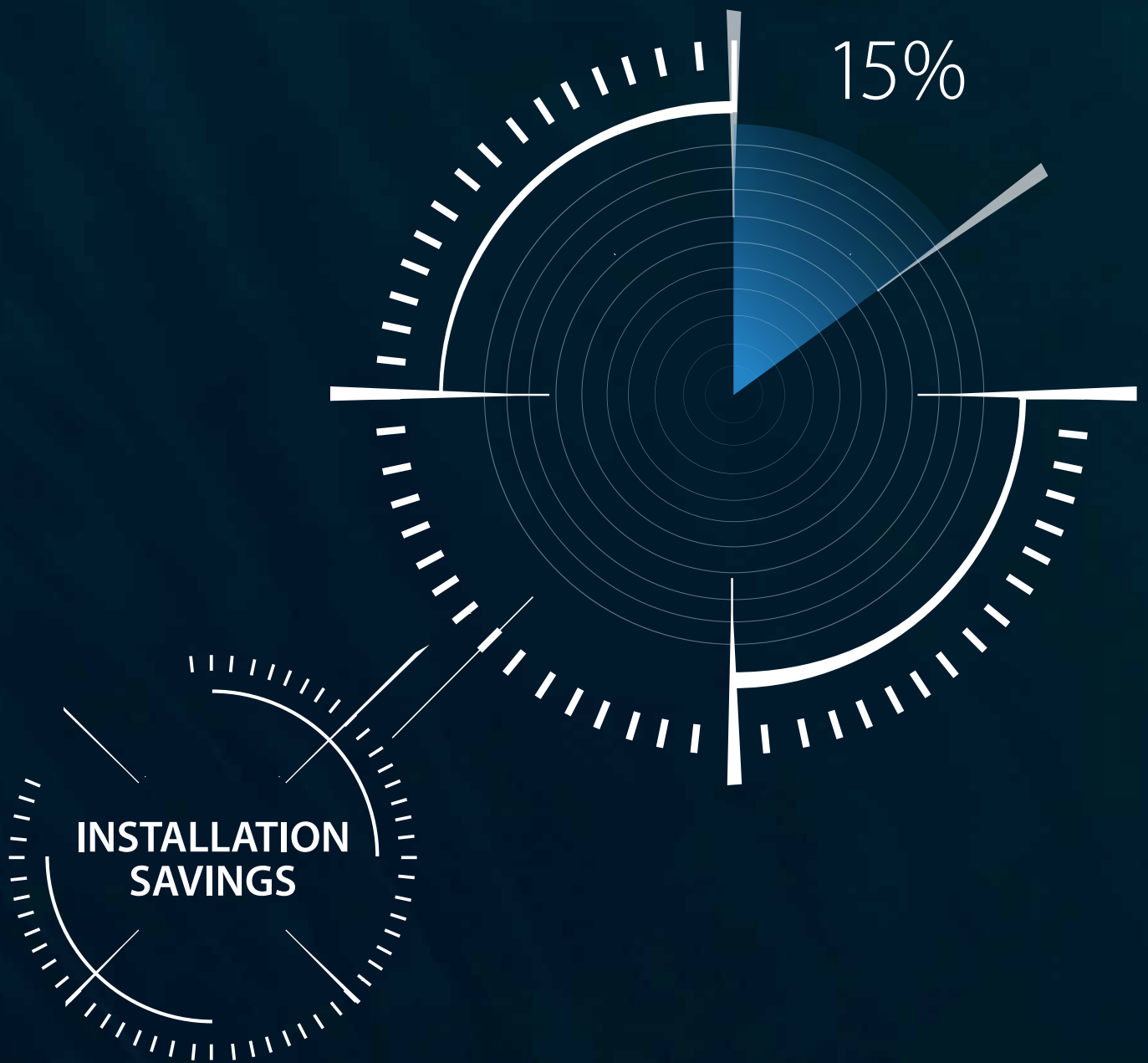

With its space-saving designs, unique heat transfer technology, new digital cascade controller, standard long motor cables and PCB protection – as well as user-friendly commissioning – the VLT® AQUA Drive offers economic installation and commissioning solutions which result in cost savings of up to 15% compared to traditional AC drives.

# Installation savings

With its space saving designs, unique heat transfer technology, new digital cascade controller, standard long motor cables and PCB protection – as well as user-friendly commissioning – the VLT® AQUA Drive offers economic installation and commissioning solutions which result in cost savings of up to 15% compared to traditional AC drives.

## Less panel space

Danfoss offers the highest power density in the market, which results in an unmatched compact design. Combined with side-by-side installation capability, the VLT® AQUA Drive delivers superior space-saving drives solutions.

## Direct outdoor installation

As standard, Danfoss offers AC drives in protection rating IP66/NEMA 4X. In addition to the convenience of having the drive close to the pump, this typically reduces cable costs, removes the need for air condition capacity and lowers control room costs.

## Long cable capability

With no need for additional components, the VLT® AQUA Drive provides flexible installation with cable lengths up to 150 m screened and 300 m unscreened to reduce installation costs.

## Air conditioning investment reduced by 90%

The unique Danfoss back-channel cooling system offers up to 90% reduction in your investment for air cooling systems to remove heat from the drives.

## Space-saving harmonic mitigation

The Danfoss central Advanced Active Filter (AAF) solution for harmonic mitigation keeps installation costs down, while reducing the size of the drive cabinet to save space in the electrical control room.

## Printed circuit board protection as standard

Minimizing your installation costs, the

VLT® AQUA Drive comes with 3C3 PCB coating as standard on 90 kW and larger drives to ensure long lifetime – even in harsh wastewater environments.

## IP66 enclosure from factory

VLT® AQUA Drives come ready in any protection class that you require for your water operation, from IP00 to IP66 – saving you installation costs, time and trouble.

## Easy commissioning

Whether it's a 0.25 kW or a 1.4 MW drive, you get the same control panel with local language, the new SmartStart function and many other time-saving features, all wirelessly accessible from your mobile device to save you installation time and hassle.

## Extended temperature range

VLT® AQUA Drives up to 315 kW operate in ambient temperatures from -25 to 50 °C without derating.

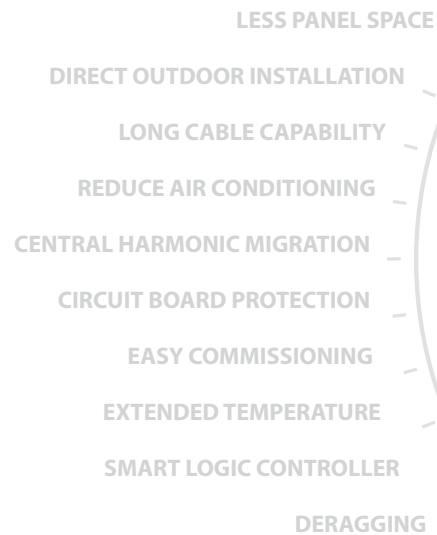

## Easy Commissioning with Auto Tuning

Auto tuning fine-tunes your system to optimal performance, while cutting out considerable programming and commissioning time.

## Smart Logic Controller

Driving down your installation costs, the integrated micro PLC functionality saves you the need for investing in an external PLC and IO module.

## Deragging

The Danfoss VLT® AQUA Drive has deragging functionality as standard, saving you the investment in an external deragger relay to considerably reduce your installation costs.

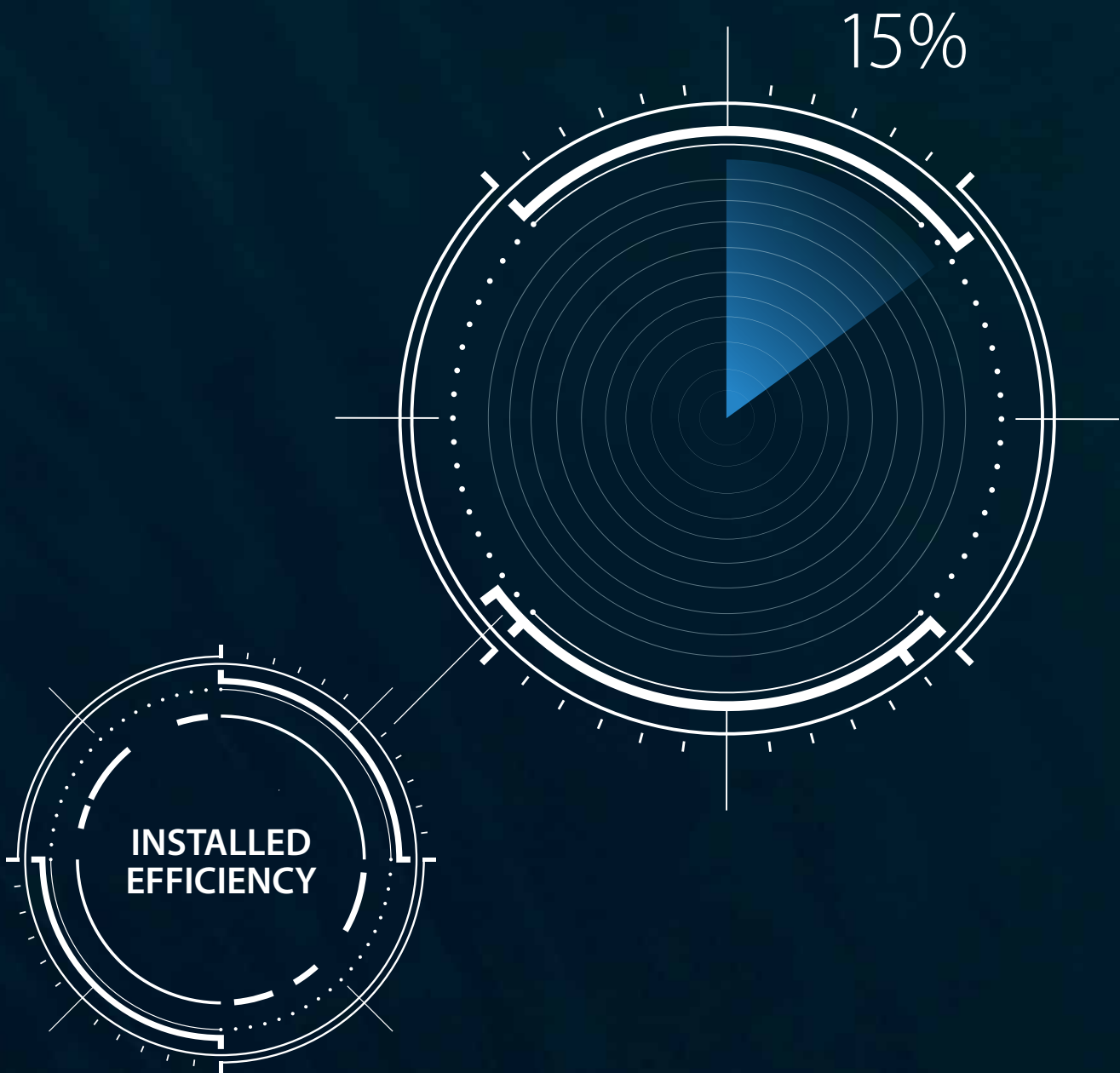

The VLT® AQUA Drive delivers energy savings of up to 15% of your investment in the drive setup annually – in addition to the savings gained by simply installing drives to adjust pump speeds to the varying loads in your water operation.



# Installed efficiency

## **Additional energy savings: up to 15%** of your drive investment each year

The VLT® AQUA Drive delivers energy savings of up to 15 % of your investment in the drive setup annually – in addition to the savings gained by simply installing drives to adjust pump speeds to the varying loads in your water operation. The 15 % savings are a result of our tight focus on energy efficiency, including the highly economical solution for harmonic mitigation and an outstanding cooling concept that considerably reduces or completely eliminates the need for air conditioning. Compared to traditional drive solutions, the savings made possible with the VLT® AQUA Drive exceed the energy savings gained by choosing an IE3 motor instead of an IE2.



BACK-CHANNEL COOLING  
HARMONIC MITIGATION  
DERAGGING  
ADVANCED MOTOR ADAPTION  
AUTOMATIC ADAPTION

### **Energy saving heat management**

A unique back-channel cooling concept transfers up to 90% of heat away from the room, using a fan-less design that exploits heat differentials in materials and air temperature and the latest developments in heat piping technology. This results in large energy savings on air conditioning.

### **Energy efficient harmonic mitigation**

The unique VLT® Low Harmonic Drive with integrated Advanced Active Filter delivers energy efficiency that is 2-3% better than traditional AC drives with Active Front End technology. Sleep function at low load ensures further energy savings.

### **Deragging for consistently high pump efficiency**

Embedded in the drive, the deragging function provides proactive maintenance with regular or load-triggered 'wash cycles' to keep impellers clean for consistently high pump efficiency.

#### ***Explore how it works***

### **Advanced Automatic Motor Adaption**

The VLT® AQUA Drive will automatically adapt to the motor to ensure supremely efficient motor performance, no matter which brand or type of motor technology you choose for your facility. The VVC+ control automatically performs advanced motor data analysis for optimum and highest efficiency control.

### **Automatic adaption to application**

Around 90% of all motors are oversized by more than 10%. Automatic Energy Optimizing functionality can deliver energy savings of 2-5% over the whole load range.



WATCH THE ANIMATION

# High uptime

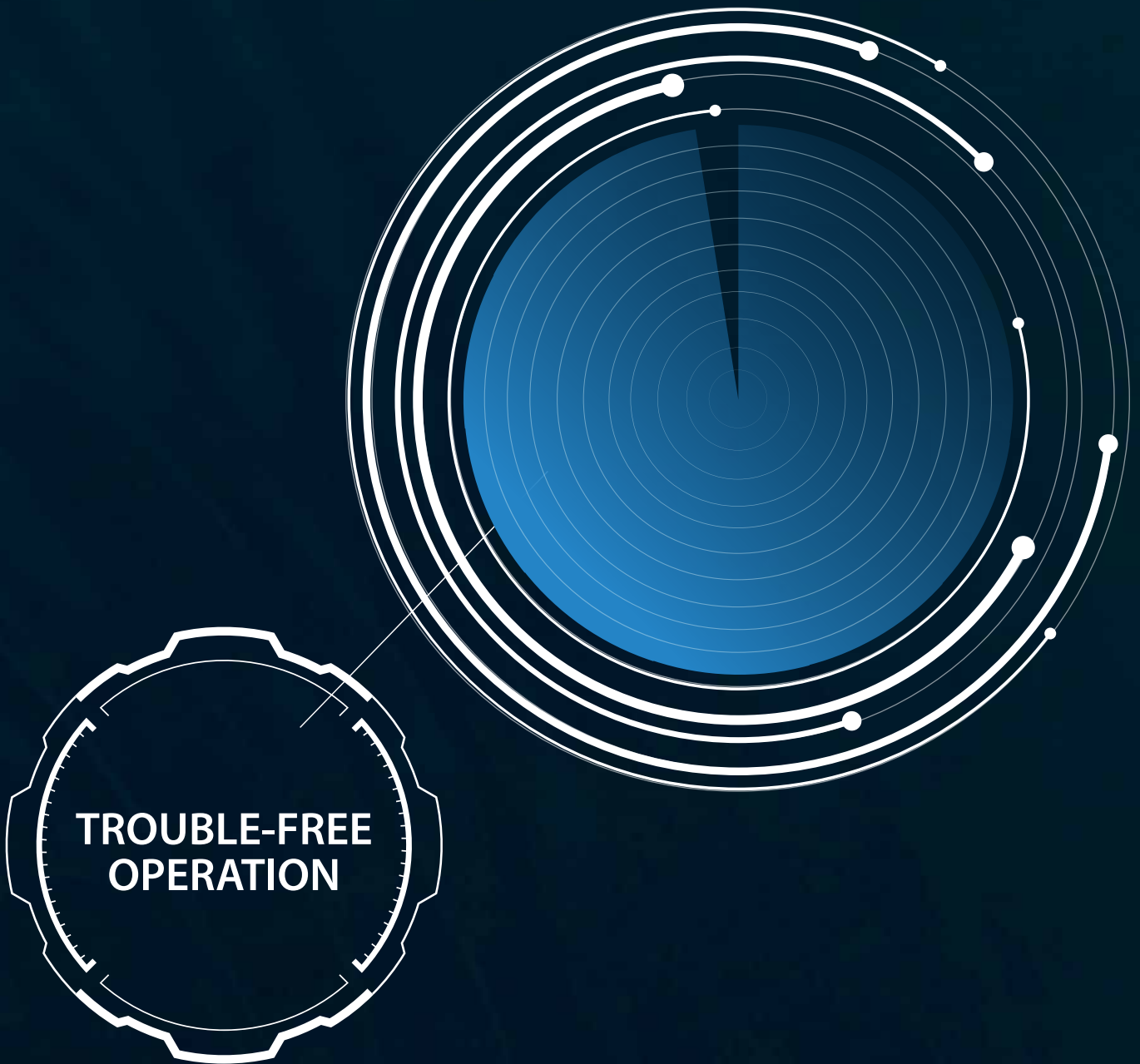

Intelligent, water-dedicated features ensure high uptime and additional energy savings for your water applications

# Trouble-free operation

Intelligent, water-dedicated features ensure high uptime and additional energy savings for your water applications.

Danfoss is the first to introduce condition-based monitoring for pumps and motors, based on edge computing embedded in the drive. Combined with the new, unique Hot Swap technology for cascade pump control and Advanced Active Filter technology for harmonic mitigation, your system will be essentially self-caring to ensure high uptime. In addition, specially designed, intelligent software features help protect your assets, prolong lifetime and reduce energy costs in many ways, including auto-cleaning of your pumps, sleep mode, reduced risk of water hammer, and safe cooling of deep-well pumps.

## Condition-based monitoring

Cloud-free artificial intelligence embedded in the drive automatically defines operating baseline parameters corresponding to specific applications, at all speeds and real-life operating cycles. Reduced installation time and predictive maintenance lower operating costs and boost uptime.

## Deragging

Wastewater facilities really benefit from the inbuilt deragging function that performs impeller washing cycles to extend manual maintenance intervals, while keeping up pump efficiency and increasing their lifetime.

## Digital cascade control

Hot Swap technology combined with back-up master functionality ensures reliable, stable and easy operation to help you avoid downtime and stay on top of maintenance issues.

## Harmonic mitigation

Increasing uptime, the unique, parallel-connected Danfoss Advanced Active Filter solution for harmonic mitigation means that your system can continue to operate in the event of an active filter failure.

## Customization – plain language communication

With our customization options you can ensure the drive communicates in the specific application terminology that your operators use. This will make it easy for service technicians to understand messages and alarms, reducing trouble-shooting time and increasing system uptime.

## Application and pump protection features

The VLT® AQUA Drive has a number of features dedicated to water applications that increase uptime, including water hammer reduction, no flow and dry-run protection and advanced minimum speed monitor for protection of deep well pumps.

## Designed for a minimum of 10 years' lifetime

With the VLT® AQUA Drive's high-quality components, maximum 80% load on components and intelligent heat management minimizing dust on PCBs, the need for routine scheduled replacements of parts, such as electrolytic capacitors and fans, has been removed.



WATCH THE ANIMATION

# In a class of its own: the most **comprehensive program** to cover **all your applications**

With the VLT® AQUA Drive, you get the most comprehensive water-dedicated program in the market. Now you can cover all your applications with the same product series and user interface.

## Improve performance with VLT® AQUA Drive in **water supply**

Pumping water out to consumers from the waterworks may seem a simple process. The fact is, that energy consumption for these pumps typically represents 60-80% of the total energy consumption for the entire water supply system. In addition to the major energy savings of around 40%

obtained by regulating the pressure in the network, using VLT® AQUA Drive to regulate the flow, the drive will typically also:

- Reduce water leakage by up to 40% based on pressure zone management

- Lower the risk of pipe and road breaks and associated costly repair work
- Extend the service life of your pipe network

## Control your **centrifugal pump** **or blower** with VLT® AQUA Drive

In a system using centrifugal or rotodynamic pumps or blowers and characterized by friction loss, you can obtain major energy savings by using

VLT® AQUA Drives. Just 20% reduction in pump speed/flowrate can result in up to 50% energy reduction.



Read the  
case studies here

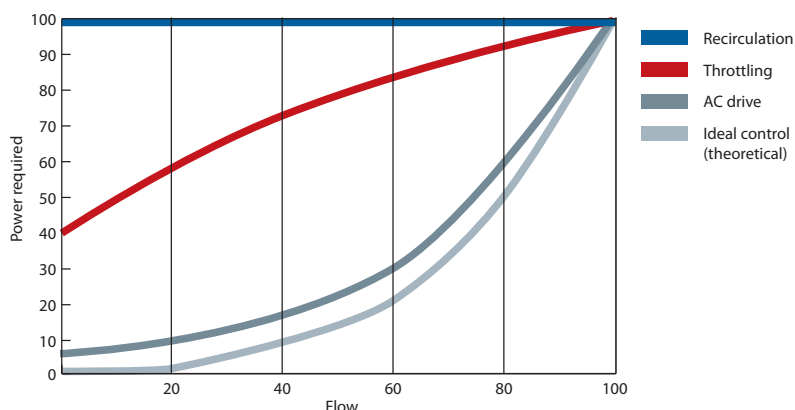

Save **20-60%**



### Try it yourself

By using the VLT® Energy Box software you can easily get a complete financial analysis for pumps including payback time – download it here:



[www.danfoss.com/vltenergybox](http://www.danfoss.com/vltenergybox)



## Improve performance with VLT® AQUA Drives in wastewater treatment

Blowers or surface aerators typically consume 40-70% of the total energy used in wastewater treatment plants. Controlling the aeration equipment with VLT® AQUA Drives can deliver energy savings of up to 50%. In addition to these major benefits, drive control of the aeration system also offers:

- Correct levels of dissolved oxygen – independent of load variations – to reduce the risk of outlet values creeping outside permitted levels
- Regulation of nitrification capacity, as a function of temperature and load variations, while limiting energy and carbon use. This approach delivers more carbon for energy generation
- Effective de-nitrification process by avoiding excessive dissolved oxygen levels
- Ammonium and nitrate sensors to ensure the correct minimum supply of oxygen where simultaneous Nitrification/Denitrification process is used
- Reduced wear on aeration equipment

## Control your positive displacement blower or pump for energy-optimized performance with VLT® AQUA Drive

In a system using positive displacement blowers or pumps, achieve high energy savings by using VLT® AQUA Drive.

A 30% reduction in speed will result in 30% energy savings, assuming constant pressure.

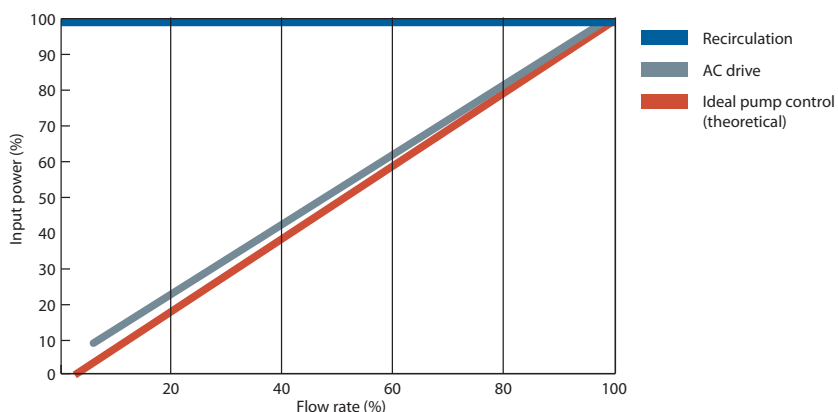

Save **20-50%**



# Back-channel cooling: Efficient and economic heat management

A cool new approach, quite literally! This Danfoss back-channel cooling system is a masterclass in thermodynamics that delivers efficient cooling using a minimal amount of energy.

## Cost-saving heat management

A compact design that exhausts 90% of system heat outside the building makes it possible to reduce the size of your cooling system in the panel or switch room. These remarkable savings are achieved with Danfoss' panel-through cooling system or the extremely efficient back-channel cooling concept. Both methods considerably reduce the installation costs of the panel or switch room, as designers can shrink the size of the air conditioning system, or even eliminate it entirely. In daily operation, the benefits are equally clear

as the energy consumption related to cooling is brought down to an absolute minimum. Combined installation and energy savings result in up to 30% cost savings in the first year of your drive investment.

## Revolutionary design

The proprietary back-channel cooling concept available for the VLT® AQUA Drive is based on a unique heatsink design, with heat pipes that conduct heat 20,000 times more efficiently than traditional solutions. Using a minimal amount of energy, the concept exploits

the heat differentials in materials and air temperature to effectively cool high performing electronics.

## Designed to protect

In VLT® AQUA Drive, there is total separation between cooling air and the internal electronics to protect them from dust-borne contaminants. Efficient heat removal helps prolong product life, increases the overall availability of the system and reduces faults related to high temperatures.

## Built to last in the toughest environment



## Ingress protection

VLT® AQUA Drives are available in a broad range of enclosure sizes and protection ratings from IP00 to IP66 to enable easy and cost saving installation in all environments: directly outdoor, mounted in panels, switch rooms or as stand-alone units in the production area.

## Coated circuit boards

The VLT® AQUA Drive conform to class 3C2 (IEC 60721-3-3) as standard. If used in particularly harsh conditions, such as wastewater treatment plants, it is possible to order a special coating that complies with class 3C3. All VLT® AQUA Drives sized above 90 kW are delivered with 3C3 coating as standard.

## Ruggedized for a super robust design

The VLT® AQUA Drive is available in a 'ruggedized' version to ensure that components remain firmly in place in pump environments characterized by high vibration levels.

## Extended temperature range

Thanks to the unique Danfoss cooling concepts, the VLT® AQUA Drive can operate in ambient temperatures between -25 and +50 °C, without derating.

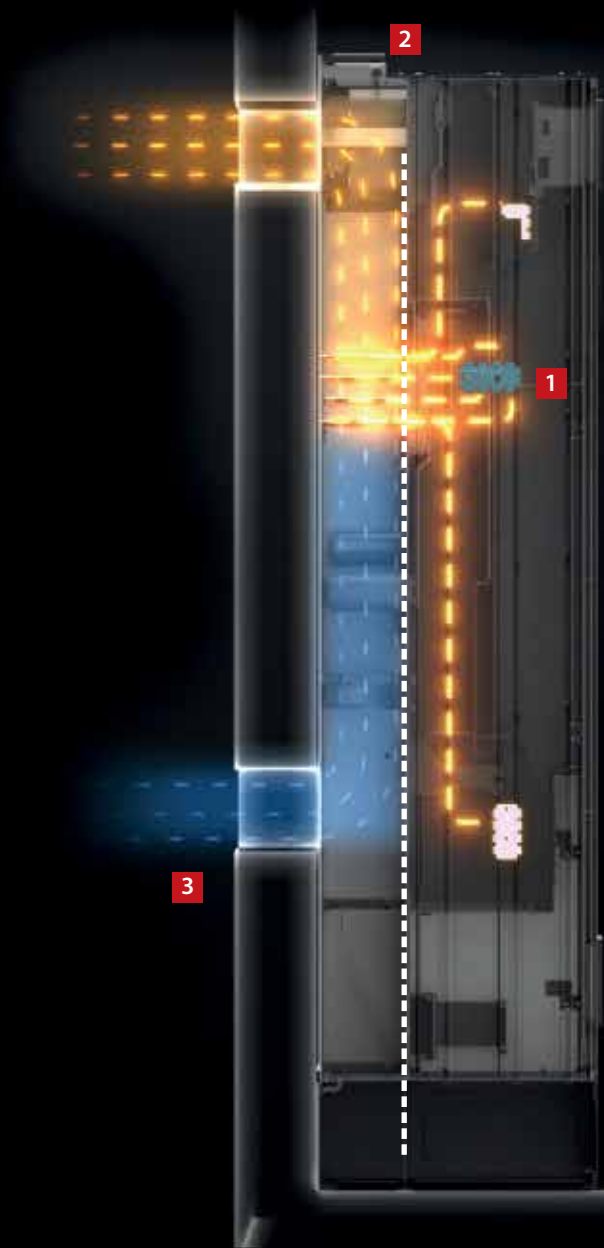

## **90% reduction** in air conditioning system and **90% reduction** in energy use for air conditioning

**1 Reduced dust over electronics**  
Complete separation between cooling air and internal electronics, ensures trouble-free operation and longer intervals between service.

**2 Panel-through cooling**  
An accessory mounting kit for small and mid-range drives enables heat losses to be directed directly outside the panel room and into designated air ducts.

**3 Back-channel cooling**  
By directing air through a rear cooling channel up to 90% of the drive's heat loss is removed directly outside the installation room.

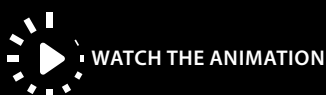

# Harmonic mitigation: **Invest less and save more!**

The Danfoss masterclass solution for harmonic mitigation is a simple space and cost-saving design that increases efficiency to provide long-term energy savings and trouble-free operation.

## **How an advanced active filter works – simply and reliably**

An active filter works in a similar way to that which noise cancelling headphones filter out extraneous sound.

Using external current transformers, the active filter monitors the supply current, including any distortion.

From this signal, the control system identifies the required compensation and creates a switching pattern for the IGBT switches.

This creates a low impedance path in the filter and harmonics flow into the filter instead of proceeding in the direction of the power supply.

By cancelling out the harmonic current distortion almost completely, voltage distortion of the transformer or generator is no longer a concern.

The filter carries out its current evaluation and cancellation continuously so that plant load variations, second-to-second or day-to-day, make no difference to the active filter's performance.

## **Meeting new standards**

Efficient harmonic mitigation protects electronics and increases system efficiency. The prescribed standard for harmonics mitigation is specified, for example in the IEEE-519 Guide, as limits for the harmonic voltage distortion and current waveforms that may exist in the system to minimize interference between electrical equipment. The latest update to this guide (2014) focuses on keeping down costs and on maintaining the voltage THD within acceptable limits at the Point of Common Coupling – defined as the interface between sources and loads. The Danfoss masterclass solution for harmonic mitigation is developed to meet the standards specified, for example in the IEEE-519 2014 Guide.

## **Minimizing costs using advanced active filters**

Danfoss offers solutions to harmonics mitigation based on either active front end or passive filter, which may be appropriate in some applications. But to achieve the ambition of ensuring the necessary harmonics mitigation, while minimizing cost and energy consumption, most applications will benefit from our central solution using advanced active filter (AAF) technology;

- It takes up less space
- It costs less to install
- It uses less energy in operation
- It reduces heat loss
- It ensures higher uptime

## **Use less energy with central advanced active filter (AAF) mitigation**

Our central advanced active filter solution encompasses up to 50 drives, ensuring harmonic noise is kept under 3% on all AC drives in the system. Connected in parallel and working in a similar way to noise cancellation headphones, advanced active filters are only active whenever necessary to maintain this level. This saves a lot of energy in comparison with Active Front End (AFE), installed in the drive itself, and requiring a voltage boost of approximately 10%.

## **Minimizing heat loss for maximum installed efficiency**

The Danfoss master class design for harmonics mitigation combines AAF technology with our unique back-channel cooling concept to achieve a 50% reduction in heat loss in the system, compared to a traditional AFE setup.

## **A future proof solution**

An upcoming amendment to the IEEE-519 Guide is very likely to include demands for harmonic components of order greater than the 50th. Already in the 2014 guide it states that "Harmonic components of order greater than 50 may be included in THD and TDD when necessary." With the Danfoss AAF solution you are prepared for this, as high-order harmonic issues are already solved.

# Only install filters, where needed

The savings gained on the installation costs and the installed efficiency of the Danfoss master class solution for harmonics mitigation exceed the improved energy efficiency achieved by investing in IE3 motors instead of IE2 motors.

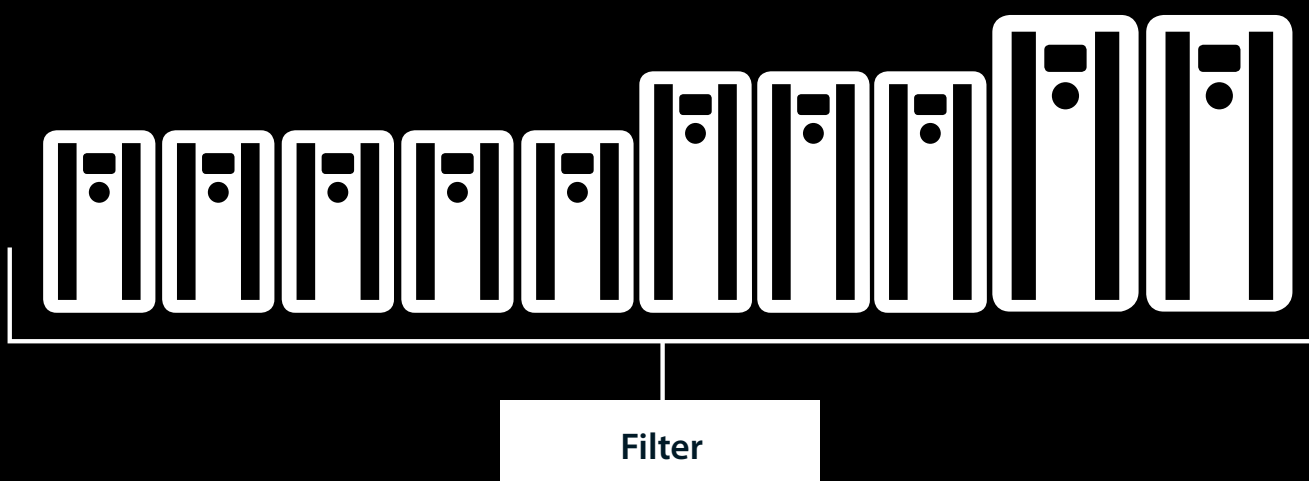
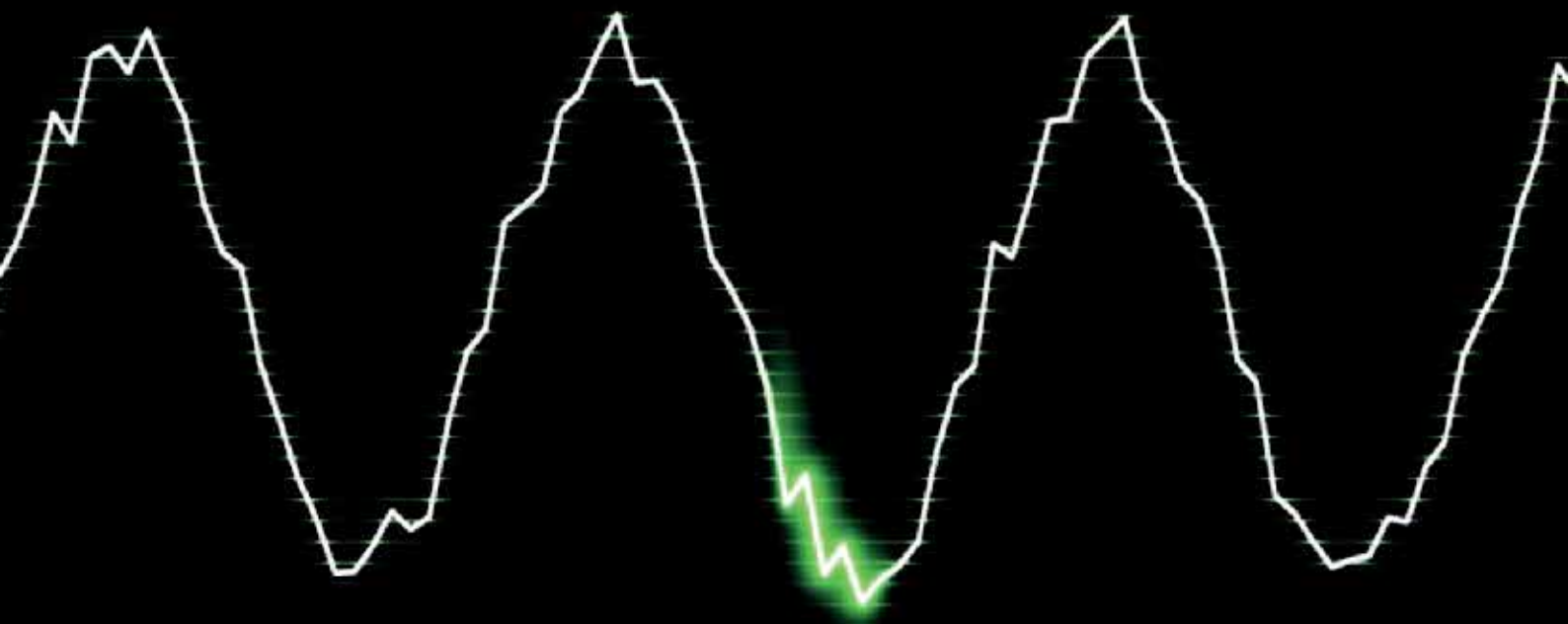



## Certified solutions to control harmonics

- Advanced active filters
- Advanced harmonic filters
- Low harmonic drives
- 12-pulse drives
- Active front end drives

## Adverse effects of harmonics

- Limitations on supply and network utilization
- Increased transformer, motor and cable heating
- Reduced equipment lifetime
- Costly equipment downtime
- Control system malfunctions
- Pulsating and reduced motor torque
- Audible noise

## Harmonic mitigation

While AC drives increase precision, save energy and extend application lifetime, they also introduce harmonic currents to the on-board grid. If not kept under control, this can affect the performance and reliability of generators and other equipment and, ultimately, compromise safety.

Danfoss offers harmonic mitigation solutions to comply with the regulations.

**Danfoss has developed a wide range of mitigation solutions which can help restore weak networks, increase network capacity, and meet compact retrofit demands – or secure sensitive environments.**

### Low harmonic drives

The VLT® low harmonic drives continuously regulate the network and load conditions without affecting the connected motor. The drives combine the well-known performance and reliability of standard VLT® drives with an Advanced Active Filter. The result is a powerful, motor-friendly solution that provides the highest possible harmonic mitigation with total harmonic current distortion (THDi) of maximum 5%.

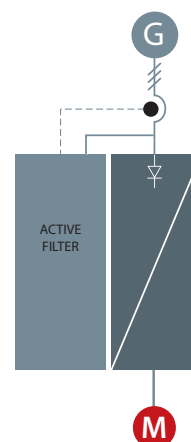



## Advanced active filters

Advanced active filters identify harmonic distortion from non-linear loads and inject counter-phase harmonic and reactive currents into the AC line to cancel out the distortion. The result is distortion levels of no more than 5% THDi. The optimal sinusoidal waveform of the AC power is restored and the power factor of the system is re-established at 1.

Advanced active filters follow the same design principles as all our other drives. The modular platform provides high energy efficiency, user-friendly operation, efficient cooling and high enclosure ratings.

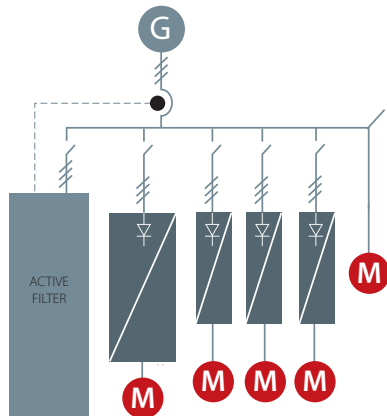

## 12-pulse drives

A robust and cost-effective harmonic solution for the higher power range, the Danfoss 12-pulse drive variants offer reduced harmonics for demanding industry applications above 250 kW.

VLT® 12-pulse drives are high efficiency AC drives which are built with the same modular design as the popular 6-pulse drives. The 12-pulse variant is available with similar drive options and accessories and can be configured according to your specific needs.

The VLT® 12-pulse drives provide harmonic reduction without adding capacitive or inductive components which often require network analysis to avoid potential system resonance problems.

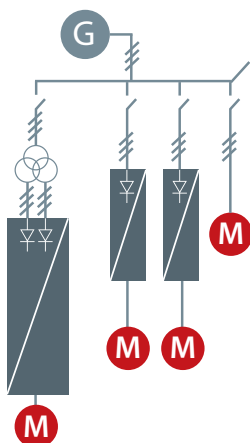

## Advanced harmonic filters

The Danfoss harmonic filters are specially designed to be connected in front of a VLT® drive, and ensure that the harmonic current distortion generated back to the mains is reduced to a minimum.

Easy commissioning saves installation costs, and due to the maintenance-free design, running expenses for the units are eliminated.

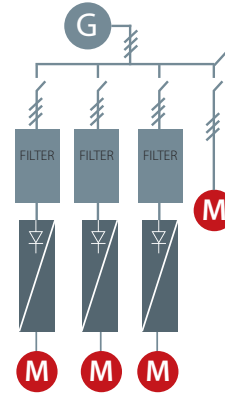

## Active front-end drives

An AFE system is a regenerative power converter located at the front end of a common DC bus drive line-up, and is suitable in applications where:

- Regenerative power generation is the goal
- Low harmonics are required
- The frequency inverter load is up to 100% of the total generator capacity

An active front-end (AFE) system comprises two identical inverters with a common DC bus. There is one motor inverter and one supply inverter. The supply inverter works together with a tuned sinus filter, and the current distortion (THDi) at the supply is about 3-4%.

When an AFE system is installed, then the motor voltage can be increased above that of the network, because adjustment of the DC link voltage is enabled. Any excessive energy can be returned to the network as clean (active) power, rather than reactive power, which only produces heat.



# Cost-effective mitigation

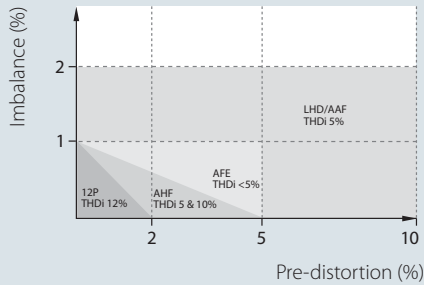

## Imbalance and pre-distortion

The harmonic mitigation performance of the different solutions depends on the grid quality. The higher the imbalance and pre-distortion, the more harmonics the equipment has to suppress. The graph shows at what pre-distortion and imbalance level each technology can keep its guaranteed THDi performance.

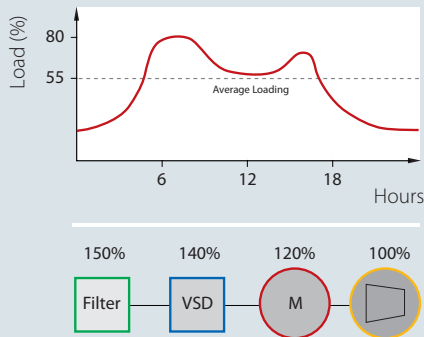
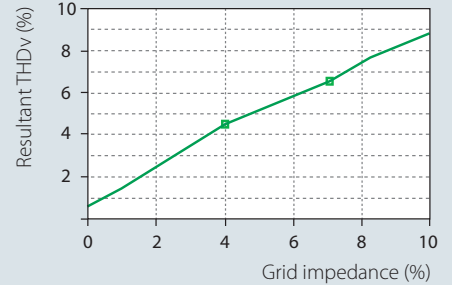

## Over-sizing

Published filter data are all given at 100% loading but filters are seldom run at full load due to over-sizing and load profile. Serial mitigation equipment must always be sized for the maximum current, but be aware of the duration of part load operation and evaluate the different filter types accordingly. Over-sizing gives poor mitigation performance and high running costs. It is also a waste of money.

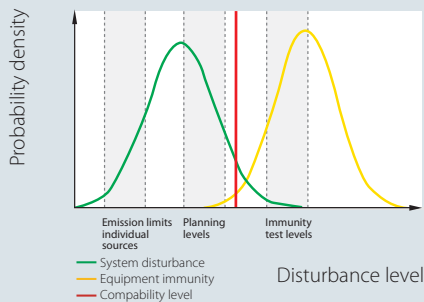
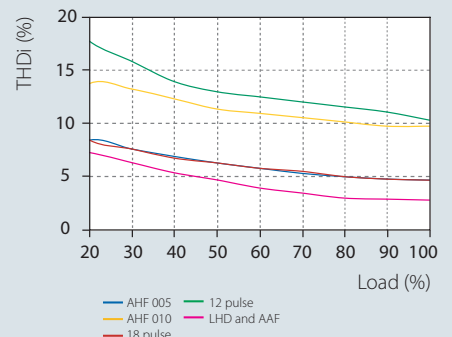

## Standards compliance

Keeping equipment immunity higher than system distortion ensures trouble free operation. Most standards set restrictions on total voltage distortion according to a planned level, often between 5% and 8%. Equipment immunity is, in most cases, far higher: for drives, between 15-20%. However, this influences product life adversely.

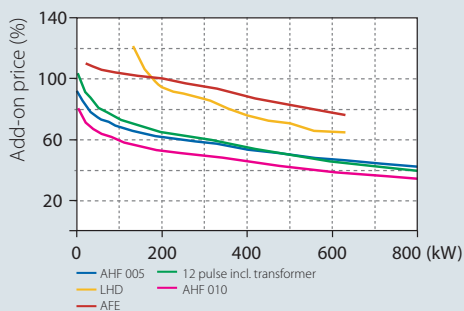
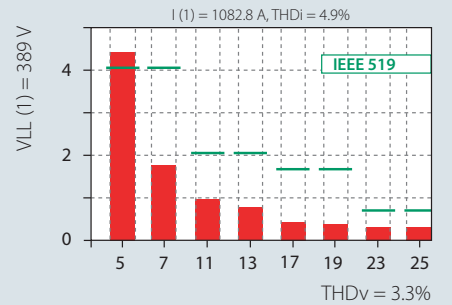

## Power size vs. initial costs

Compared to the AC drive, the different solutions have different add-on prices depending on power size. The passive solutions in general offer the lowest initial cost and as the complexity of the solutions increase, so does the price.

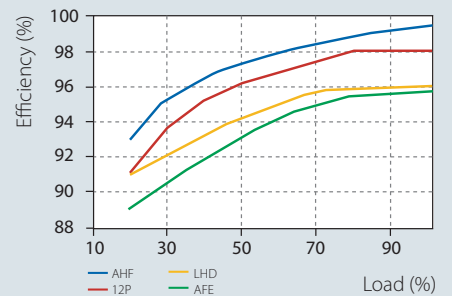

### System impedance

As an example, a 400 kW FC 202 drive on a 1000 kVA transformer with 5% impedance results in ~5% THDv (total harmonic voltage distortion) at ideal grid conditions, whereas the same drive on a 1000 kVA, 8% imp. transformer leads to 50% higher THDv, namely 7.5%.

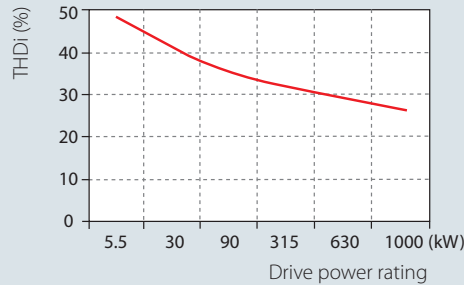

### Total Harmonic distortion

Each drive generates its own total harmonic current distortion (THDi) which depends on the grid conditions. The bigger the drive is in relation to the transformer the smaller the THDi.

### Harmonic performance

Each harmonic mitigation technology has its own THDi characteristic which is load dependent. These characteristics are set at ideal grid conditions without pre-distortion and with balanced phases. Variations hereof will result in higher THDi values.

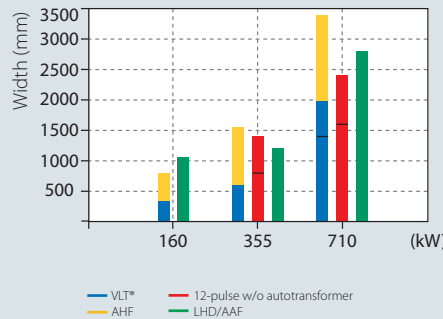

### Wall space

In many applications the amount of available wall space is limited and must be utilized to the greatest extent possible. Based on different technologies, the various harmonic solutions each have their optimum size and power relationship.

### Fulfilling the standards

To determine whether or not the harmonic pollution of a given application/grid exceeds a specific standard, many complex calculations must be done. With the help from free Danfoss MCT31 harmonic calculation software, this is made easy and less time consuming.

### System efficiency

The running cost is mainly determined by the overall system efficiency. This depends on the individual products, true power-factors and efficiencies. Active solutions tend to keep the true power-factor independent of load and grid variations. On the other hand, active solutions are less efficient than passive solutions.

## Energy consumption [kWh]

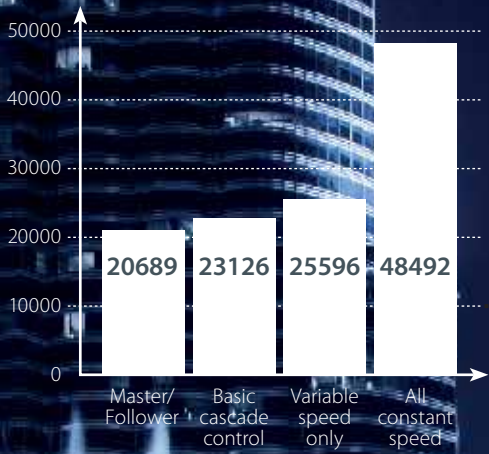

Using Master/Follower mode can reduce the energy consumption to less than half compared to traditional technology across the line for on/off cycling of pumps or blowers, and valve throttling.

## Optimize your system with the right level of cascade control

VLT® AQUA Drive FC 202 offers you four levels of cascade control. Choose the level just right for your system.

Integrated cascade control:

- Basic Cascade Controller
- Digital Cascade Controller

Plug-in options:

- VLT® Extended Cascade Controller MCO 101
- VLT® Advanced Cascade Controller MCO 102

	Level 1	Level 2	Level 3	Level 4
Built-in	1 VSP + 2 FSP Max 3 pumps	—	—	—
VLT® Extended Cascade Controller MCO 101	1 VSP + 5 FSP Max. 6 pumps	1-6 VSP + 1-5 FSP Max 6 pumps	6 VSP	—
VLT® Advanced Cascade Controller MCO 102	1 VSP + 8 FSP	1-8 VSP + 1-7 FSP Max 8 pumps	8 VSP	—
Digital Cascade Controller [LXX1 (Modbus)]	—	—	8 VSP	8 VSP

VSP: Variable Speed Pump (VLT®)  
FSP: Fixed Speed Pump



# Unique cascade controller, based on **Hot Swap technology**

The integrated Digital Cascade Controller reduces installation costs and commissioning time – while ensuring high uptime and trouble-free operation.

With the integrated Digital Cascade Controller, you obtain a super-intelligent, self-caring system with automatic fault detection and self-propelled back-up measures to optimize your operations more than ever. The Digital Cascade Controller enables you to configure up to eight pumps in multiple-pump systems to work in an optimized, energy efficient manner. And it minimizes downtime when maintenance on the system is required.

Based on the Modbus RTU communication protocol, the Digital Cascade Controller is ready to use; simply activate it with a software license key.

## Instant system overview

The Digital Cascade Controller enables communication from all pump drives in the system to the master drive. The master continuously monitors the status of the drives connected and can therefore act on any change in pump availability, while providing one communication point for a complete system monitoring overview.

## Eight pumps in three modes

The Digital Cascade Controller controls speed and sequence of up to eight pumps or blowers in three modes. In all three modes, pumps are staged on or off according to need.

## Standard cascade mode

- Variable speed control of one pump and on/off control of the remainder
- Supports the use of soft starters

## Mixed pump mode

- Variable speed control of a few pumps and on/off control of the remainder
- Support of unequally sized pumps

## Master/Follower mode

- Controls all pumps with optimized speed. Choose this mode to achieve maximum energy optimization
- Ensures maximum performance with minimum pressure surges

## Intelligent, self-supporting system with Hot Swap

Automatic drive detection supports Hot Swap to ensure a totally reliable system, proofed against loose connections or cable failure. During drive maintenance, the system automatically re-allocates roles in the master/follower architecture to avoid downtime and provide full overview and control of the system, while the faulty drive is being maintained. After maintenance is complete, the cascade controller automatically incorporates the drive back into the loop and gives you the chance to re-allocate master/follower roles.

## Run-time balancing for more uptime and less wear

The cascade controller can balance the run-time for each pump in a system to maximize uptime. Extending pump lifetime expectancy and reliability

considerably, the cascade controller distributes operation hours evenly across all pumps to keep wear and tear on individual pumps to a minimum. Set alternation of pumps to take place when in sleep mode, when a pump is destaged, or at preset times for optimal fit to your specific application needs.

## Easy commissioning and service

Daisy-chain-connected drives significantly reduce wiring complexity. The embedded fieldbus communication protocol uses an absolute minimum of set-up parameters, which makes installation and commissioning easier than ever.

## Easy upgrade to masterclass

Since the Digital Cascade Controller is license-based, it is very easy to activate, in order to raise the level of cascade control performance. Activation is instant with no extra space or hardware required.

## Reduce energy consumption

Use Master/Follower mode to more than halve energy consumption compared to traditional technology across the line during on/off cycling of pumps or blowers, and valve throttling.

Built for:	Who benefits?
<ul style="list-style-type: none"><li>▪ Water distribution and booster pumps</li><li>▪ Wastewater lift stations (normal or inverse)</li><li>▪ Aeration blowers</li><li>▪ Irrigation pumps</li></ul>	<ul style="list-style-type: none"><li>▪ Pump and blower OEMs with multiple pump-blower systems</li><li>▪ System integrators/installers<ul style="list-style-type: none"><li>– booster set manufacturers</li><li>– pump skid manufacturers</li></ul></li><li>▪ Anyone interested in a high level of process control and energy conservation in multi-pump or blower systems</li></ul>



# A master of **all motor technologies**

Save commissioning time and fine-tune for optimal system control

## **Free choice of motor**

Danfoss gives you a free choice of motor supplier and supports all commonly used motor types. The VLT® AQUA Drive offers control algorithms for high efficiency and trouble-free operation with standard induction motors, permanent magnet (PM) motors, asynchronous and synchronous reluctance motors. This means you can combine a VLT® AQUA Drive with your favorite motor technology to achieve a masterclass performance.

## **Straight into action with Automatic Motor Adaption**

Allowing you to access optimal, dynamic motor performance with just a

few clicks, the AMA function saves you a lot of time and effort when setting up the system. Guided by the SmartStart start-up wizard, you just have to enter the basic motor data, such as currency and voltage, which are found on the motor name plate, and you are straight into action.

## **Automatic Energy Optimization**

With the AEO feature we have made a complex task easy and available with only a few clicks. The integrated AEO function ensures optimal energy-efficient speed control of the pump, while adapting the voltage exactly to the current load situation to reduce energy consumption.

## **Super-easy commissioning with Auto Tuning**

Auto tuning fine-tunes your system to optimal performance, while cutting down on programming. The auto tuning function measures a series of system characteristics and automatically finds the settings of the process controller for stable and precise system control.



# Save commissioning time with SmartStart

SmartStart is a setup wizard that is activated at the first power up of the drive, or after a factory reset. Using easy to understand language, SmartStart guides you through a series of easy steps to ensure correct and efficient motor control. Start the wizard directly via the Quick Menu on the graphical control panel.

First, select which type of motor setup is used in the application:

- **Single pump/motor** in open or closed loop
- **Motor alternation:** when two motors share one drive
- **Basic cascade control:** speed control a single pump in a multi pump system. This is a cost attractive solution in for example booster sets
- **Master-follower:** Control up to 8 drives and pumps to ensure smooth operation of the overall pump system

- **Automatic Motor Adaptation:** SmartStart also guarantees an optimized motor performance due to the adjustment of efficiency settings, regardless of the motor type. After entering the basic motor data, the Automatic Motor Adaptation function measures the motor parameters and optimizes the drive settings at standstill without the need to disconnect the load.

The guide then continues with selection of dedicated water and pump features:

- **Flow compensation:** the drive adapts the set-point according to the flow
- **Deragging:** removes clogs from impellers by reversing the direction of the flow in cycles. This can be used as proactive measure to avoid damaging the pump

- **Pipe fill:** helps to avoid water hammering by filling pipes smoothly
- **Dry run/end of curve detection:** protects the pump from damage. If a set-point is not reached, the drive assumes that the pipe is dry or there is a leakage
- **Sleep mode:** saves energy by stopping the pump when there is no demand
- **Special ramps:** dedicated startup and stop ramps for specific applications

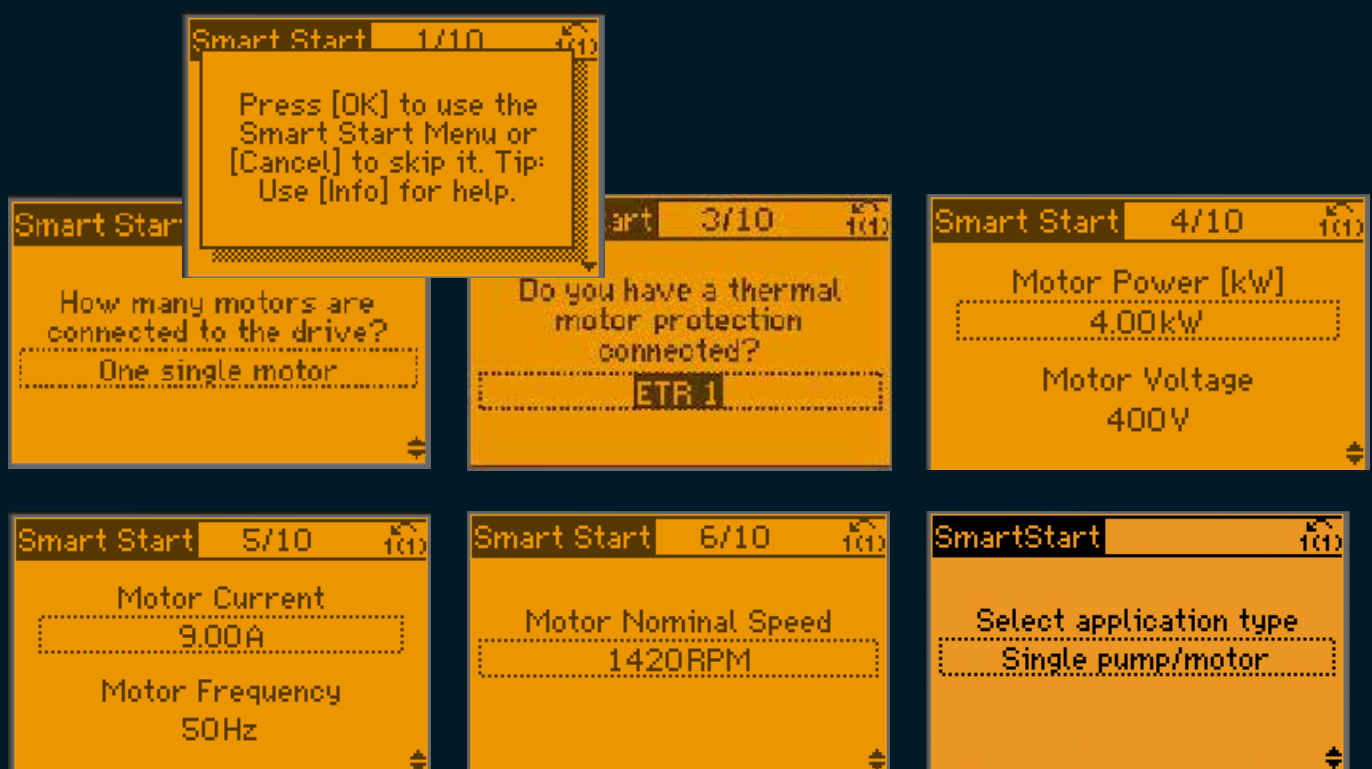

# Customize and be your own master

## Make the VLT® AQUA Drive your own

The VLT® AQUA Drive masters all the world's most commonly-used languages and you can easily make it speak the language of your own specific installation. Apart from selecting your language, the VLT® AQUA Drive gives you a wealth of options for setting your drive up to serve your specific application or customer needs. Whether you are an end user or an OEM, our customization options allow you to make the drive your own for easy commissioning and trouble-free operation:

- Choose the parameters that are most important to show in the display for your operation.
- We have carefully selected the initial values with the typical user in mind. But it is also possible to enter your own values and save them as factory settings for a particular application segment.

- Set up your own start-up wizard to customize the drive for your users. No programming required, you simply and intuitively drag and drop to select your parameters.
- Splash-Screen; import your logo from a jpg or any other commonly used file type to have your own name featured on the display.
- Make the drive speak your application's language by naming terminals according to functions.
- The VLT® AQUA Drive allows for several password functions with various ways of locking access and allocating user rights.

## SmartLogic Controller for easy customization

Taking customization to the next level, the VLT® AQUA Drive lets you access functions that are not actually installed on the drive and which would normally require development of new software or complicated programming. With

our SmartLogic Controller (SLC) you can create new functions via simple, intuitive drop-down selections that give you numerous options for setting the drive to specific application needs. The SLC allows you to run up to four sequences in parallel, and you can link between them to create customer and application specific behavior for easy and trouble-free operation.

## Hassle-free trouble-shooting with user-defined alerts

Make error codes a thing of the past with user-defined alerts that make any system warning understandable to any user. When the drive speaks application language, rather than drives language, service technicians can get guidelines straight from the display and immediately take the action required.





# Flexible, modular and adaptable

A VLT® AQUA Drive is built on a flexible, modular design concept to provide an extraordinarily versatile motor control solution. The drive is equipped with a wide range of features dedicated to the water and wastewater businesses. Optimal process control, higher quality output and reduced costs related to spare parts and service, are among the benefits.

## Up to 1.4 MW

Available in a performance range from 0.25 kW to 1.4 MW the VLT® AQUA Drive FC202 series can control nearly all standard industrial motor technologies, including permanent magnet motors, synchronous reluctance motors, copper rotor motors and direct line PM.

This drive is designed to work with all common supply voltage ranges: 200-240 V, 380-480 V, 525-600 V and 525-690 V. This means that system designers, OEMs and end users are free to connect the drive to their chosen motor and remain confident that the system will perform to the highest possible standards.

## 690 V

The 690 V versions of VLT® AQUA Drive units can control motors down to 0.25 kW without step-down transformer. This enables you to choose from a broad variety of compact, reliable and efficient drives for demanding applications operating from 690 V mains networks.

## Reduce costs with compact drives

Reducing initial costs, our compact design and efficient heat management mean the drives take up less space in control rooms. For example, the VLT® AQUA Drive FC202 from 75-400 kW are 25-68% smaller than previous, equivalent Danfoss drives. Especially impressive are the 690V versions, which are among the smallest in their power class on the market today, and available in an IP54 enclosure.

Despite the compact dimensions, all units are nevertheless equipped with integrated DC link chokes and EMC filters, which help to reduce grid pollution and reduce cost and efforts for external EMC-related components and wiring.

The IP20 version is optimized for cabinet mounting and features covered power terminals to prevent accidental contact. The IP54/55 units can also be ordered with optional fuses or circuit breakers in the same package size. Control and power cables are fed in separately at the bottom.

These drives combine a flexible system architecture, which allows them to be adapted to specific applications, with a uniform user interface across all power classes. This allows you to adapt the drive to the exact needs of your specific application. As a result, project work and costs are subsequently reduced. The easy-to-use interface reduces training requirements. The integrated SmartStart guides users quickly and efficiently through the setup process, which results in fewer configuration-related faults.

## VLT® platform highlights

- Versatile, flexible, configurable
- Up to 1.4 MW in common voltages
- Asynchronous, Synchronous Reluctance and PM motor control
- 7 fieldbuses supported
- Unique user interface
- Globally supported
- EMC filters integrated as standard



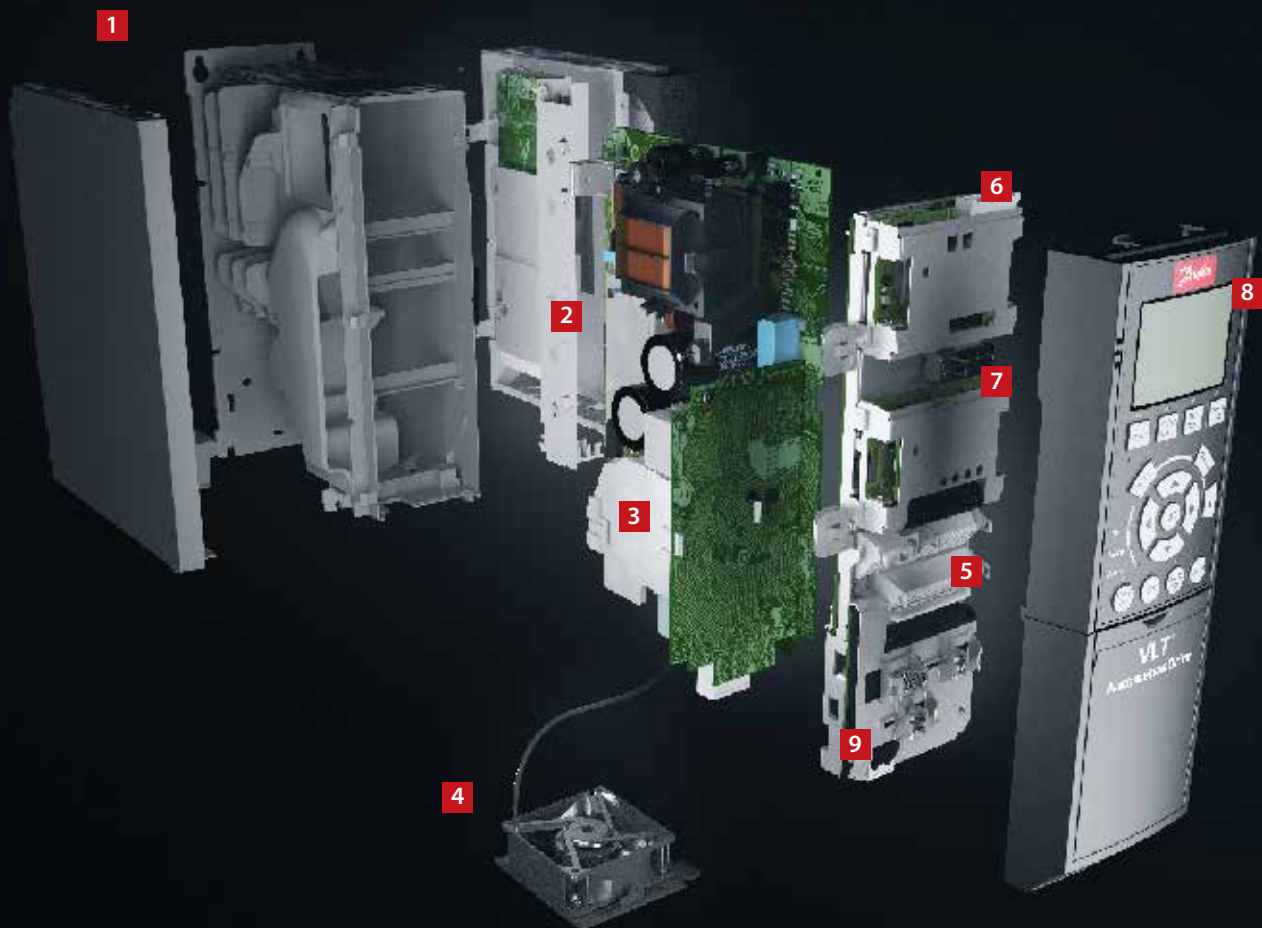

# Modular simplicity – A, B and C enclosures

Delivered fully assembled and tested to meet your specific requirements

## 1. Enclosure

The drive meets requirements for enclosure class IP20/Chassis. IP21/Type 1, IP54/Type 12, IP55/Type 12 or IP66/Type 4X.

## 2. EMC and Network effects

All versions of VLT® AQUA Drive comply as standard with EMC limits B, A1 or A2 according to the EN 55011 norm. The standard integrated DC coils ensure low harmonic load on the network according to EN 61000-3-12 and increase the lifetime of the DC link capacitors.

## 3. Protective coating

The electronic components are, as standard, coated as per IEC 60721-3-3, class 3C2. For harsh and aggressive environments, coating as per IEC 60721-3-3, class 3C3 is available.

## 4. Removable fan

Like most of the elements, the fan can be quickly removed and remounted for easy cleaning.

## 5. Control terminals

Double-stack, spring-loaded cage clamps enhance reliability and facilitate easy commissioning and service.

## 6. Fieldbus option

See complete list of available fieldbus options on page xx.

## 7. Cascade controller and I/O extensions

Controls multiple pumps. See also pages 22 and 23.

A wide range of I/O options are available either factory-mounted or as retrofit.

## 8. Display option

Danfoss Drives' removable Local Control Panel is available with a variety of language packs.

Alternatively, the drive can be commissioned via the VLT® Motion Control Tool MCT 10 setup software.

## 9. 24 V external power supply

The external 24 V supply keeps the VLT® AQUA Drive logic "alive" when the AC mains is removed.





### 10. Mains disconnect

This switch interrupts the mains supply and has a free useable auxiliary contact.

#### Safety

The VLT® AQUA Drive can optionally be delivered with the Safe Torque Off (Safe Stop) functionality suitable for category 3, performance level d according to EN 13849-1 and SIL2 according to IEC 62061/IEC 61508. This feature prevents the drive from starting unintended.

#### Built-in Smart Logic Controller

The Smart Logic Controller is a clever way to add customer-specific functionality to the drive and increase the opportunities for the drive, motor and application working together.

The controller monitors a specified event. When an event occurs, the controller performs a pre-defined action and then starts monitoring for the next pre-defined event. 20 steps of events and resulting actions are available before returning to the first set.

Logic functions can be selected and run independently from the sequence control. This enables drives to monitor variables or signal-defined events in an easy and flexible way independently of the motor control.



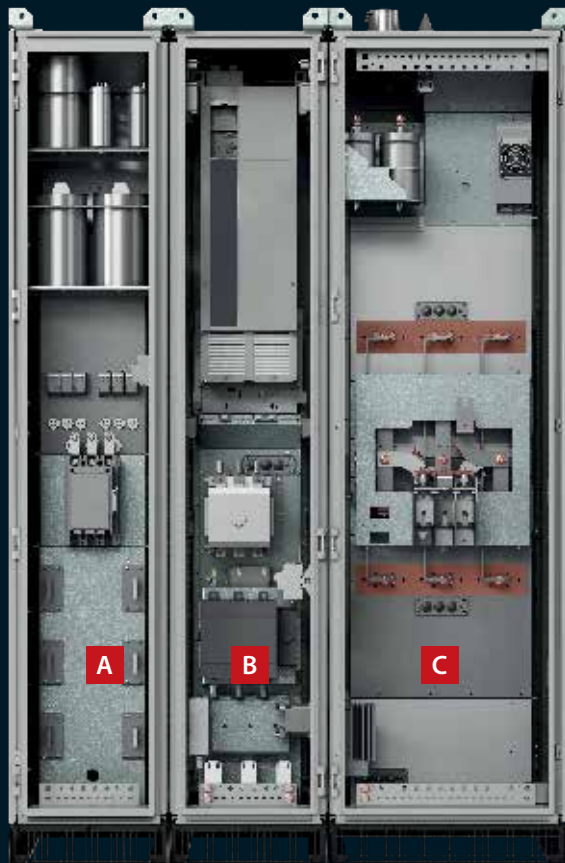

- A** Input filter cabinet
- B** Drive cabinet
- C** Output filter cabinet

## Extended functionality for **high-performance operation** – Enclosed Drives

The high-power VLT® AQUA Drive Enclosed Drives have been designed to meet the most demanding requirements for flexibility, robustness, compactness and ease of service. Each enclosed drive is precisely configured in flexible mass production, then individually tested and delivered from the Danfoss factory.

### 1. Door-mounted control compartment

separate from the main power terminals ensures safe accessibility to control terminals, also during operation of the drive.

### 2. VLT® AQUA Drive

high-power drive in enclosure size D or E, with selectable control options.

### 3. Back-channel cooling assembly for power options

ensures utilization of the drive's back-channel cooling concept in the cabinet and efficient cooling of the integrated selectable power options.

### 4. Mains contactor

is a selectable mains power option.

### 5. Mains switch disconnect

is a selectable mains power option.

### 6. Bottom entry establishment

ensures IP54/NEMA12 connections of the enclosed drive mains terminals to the power supply.

### 7. Mains reactor assembly

of the selectable passive harmonic filter ensures absolute minimum harmonics content of the mains currents: **THDi <5%**.

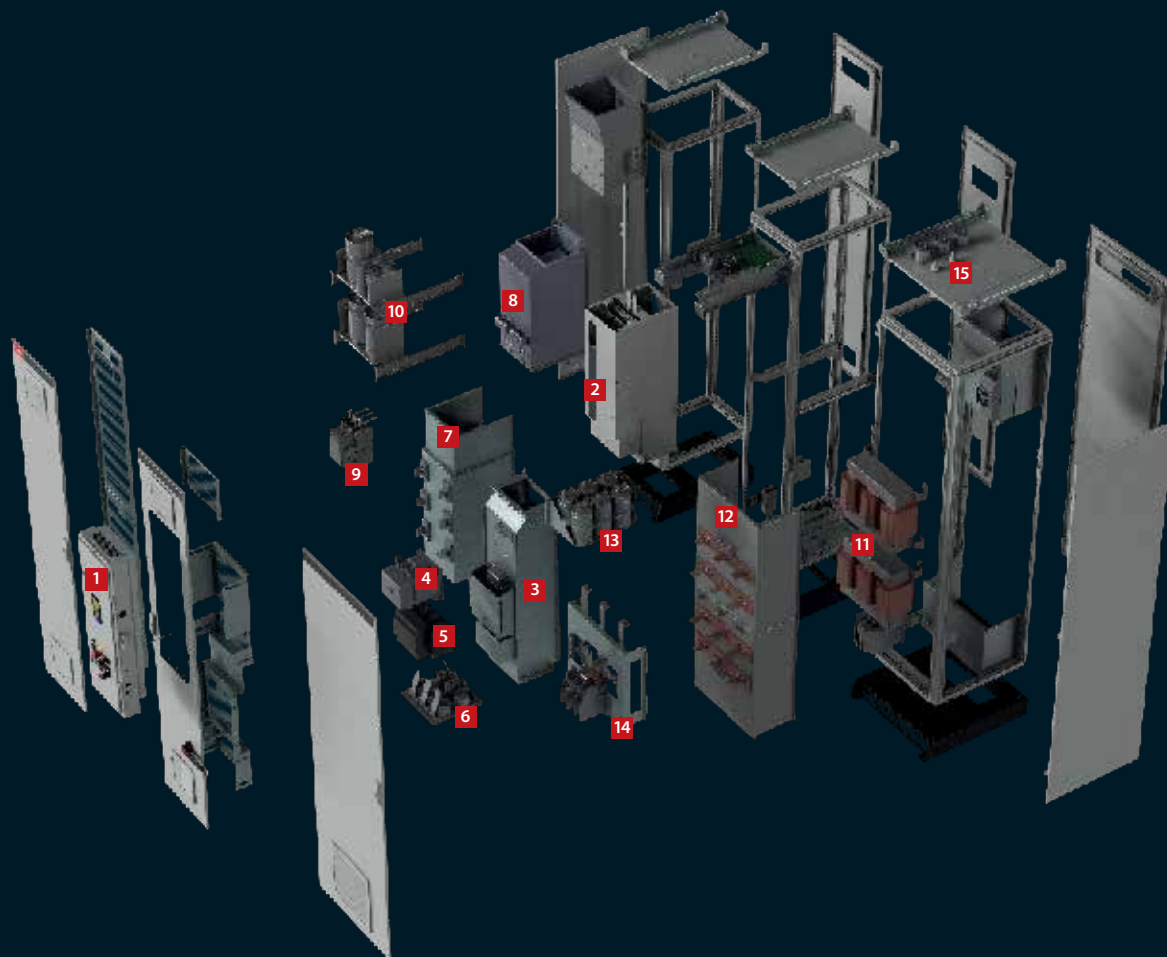

**8. Passive filter magnetics**  
and the mains reactor of the passive filter are integrated into the back-channel cooling assembly of the cabinet.

**9. Contactor**  
to control the passive harmonic filter of the drive.

**10. Capacitor assembly**  
for the mains current passive harmonics filter.

**11. Sine-wave filter magnetics**  
of the output filter, as a selectable power option.

**12. Back-channel cooling assembly**  
for magnetics of the output sine-wave filter.

**13. Capacitor assembly**  
for the sine-wave filter.

**14. Motor connection terminals**  
are located in the sine-wave filter cabinet.

**15. Top exit establishment**  
ensures IP54/NEMA12 connections of motor cables from the top.



## Dedicated **water** and **pump** features

Integrated features that save energy, increase efficiency and ensure trouble-free operation for a masterclass performance in all water and pump applications.

### 1. End of curve detection

This feature is triggered if the pump runs without reaching a predefined set-point. The drive then either sets off an alarm or performs another pre-programmed action – for example, when a pipe leaks.

### 2. Auto tuning of the Process Controllers

Auto tuning enables the drive to learn how the specific system reacts to either flow or pressure changes. The auto tuning measures the response and delay of the system, archives the data and uses it in advanced Ziegler-Nichols tuning method calculations for best disturbance rejection. This saves expensive commissioning time and eliminates the risk of overshooting the set-point using a too high or too low value.

### 3. Flow compensation

A pressure sensor mounted close to the fan or pump provides a reference point that enables pressure to be kept constant at the discharge end of the system.

The drive constantly adjusts the pressure reference to follow the system curve. This method both saves energy and reduces installation costs.

### 4. No flow/low flow detection

The VLT® AQUA Drive has intelligent no/low flow detection that enables sophisticated, economical pump operation. This unique feature makes it possible to detect no-flow conditions, even in systems with fluctuating suction pressure or a flat characteristic towards low speed. Monitoring speed and power, the drive will establish a curve to describe the power at no flow and provide a warning or set off other action defined in such a situation. To further improve low-speed detection, the VLT® AQUA Drive also gives the option of using a step/response feature, which creates a brief pressure pulse to automatically detect a steady state.

### Advanced sleep mode

The VLT® AQUA Drive has advanced sleep mode functions to conserve energy, which are automatically activated in cases of no/low flow situations. A unique boost function that temporarily increases the load will prolong the sleep mode when there is no need for the system to be active, this way increasing energy savings and extending the lifetime of the application.

### 5. Deragging feature

This VLT® AQUA Drive software feature offers proactive pump protection. The deragging can be configured as either a preventative or reactive action. It optimizes the efficiency of the pump by constantly monitoring the motor shaft power consumption relative to flow. In the reactive mode, the drive senses the beginning of a pump clog and will enter washing mode by reversing the pump spin to ensure a clear path for the water. As a preventative action, the drive can be set up to reverse the pump at set intervals for regular self-maintenance.

### 6. Pipe fill mode

Useful in all applications where controlled pipe filling is essential, such as irrigation and water supply systems. Controlled filling of pipes prevents water hammering, bursting water pipes or blowing off sprinkler heads. Pipe fill mode can be used in both vertical and horizontal pipe systems

### 7. Initial/final ramp

The initial ramp provides fast acceleration of pumps to minimum speed, from where the normal ramp takes over. This prevents damage to the thrust bearings on the pump. The final ramp decelerates pumps from the minimum speed to stop.



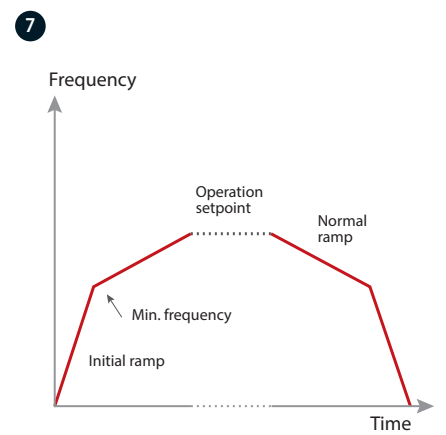
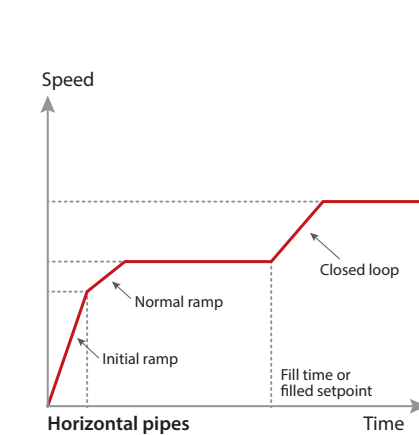
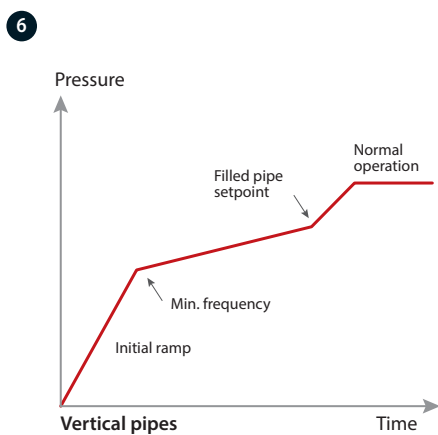
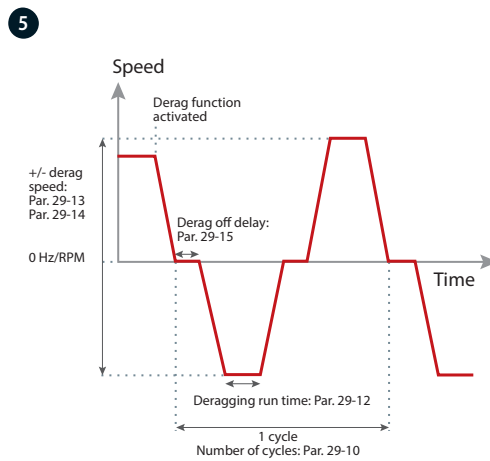
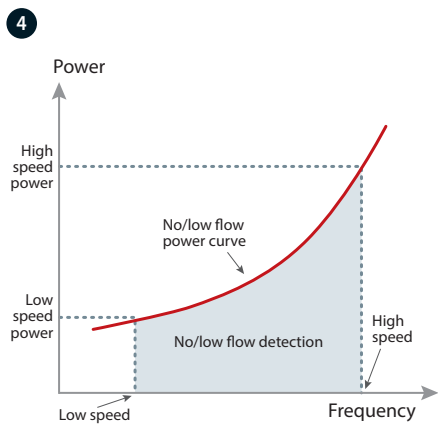
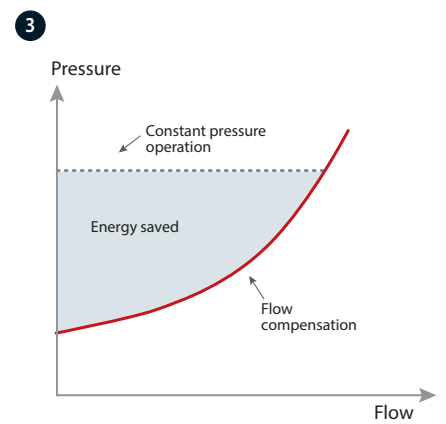
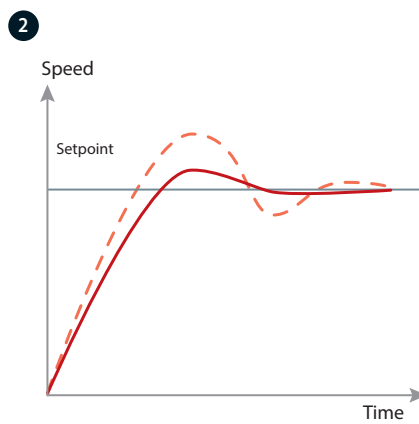
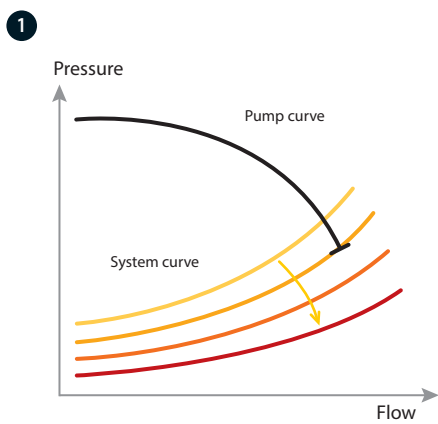



8

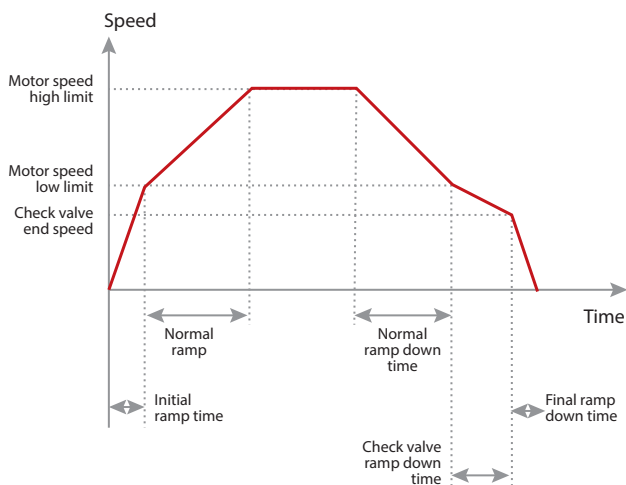

### 8 Check valve ramp

The check valve ramp prevents water hammering when stopping the pump, by ensuring slow pump speed ramp down just as the check valve ball is almost shut.

### 9. Flow confirmation

The flow confirmation monitor protects equipment from unexpected flow stoppage. The monitor communicates on an ongoing basis with an external device such as a valve or flow switch. If there's no signal from the external device to confirm the flow before the flow verification time expires, the monitor trips the frequency converter.

9

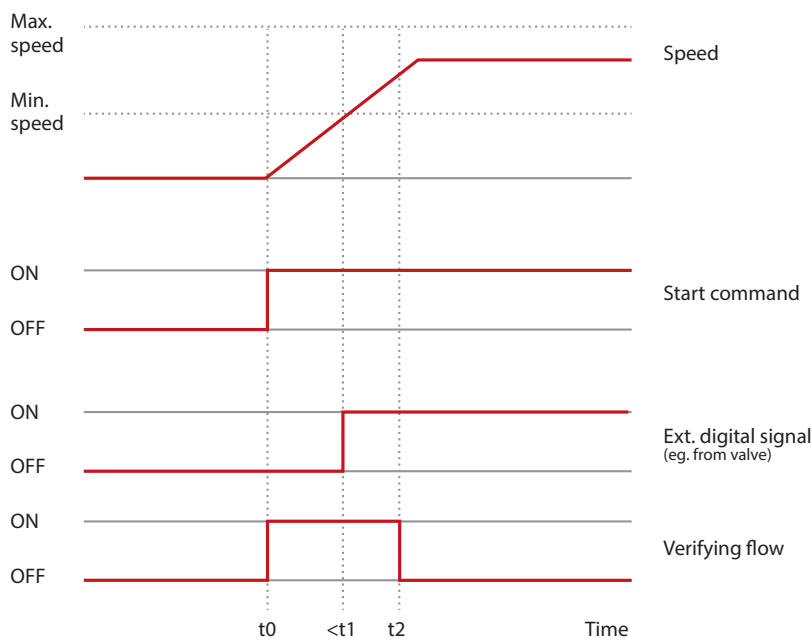

### 10. Pre/post lubrication

Some machines require lubrication of their mechanical parts before and during operation to prevent damage and reduce wear. During lubrication, certain equipment must remain active, for example exhaust fans. To achieve this, the Pre Lube feature supports a signal to an external device to perform a specific action for a user-defined time period. Configurations available: "Pre Lube Only", "Pre & Running" and "Pre & Running & Post".



### 11. Freely programmable texts

This function supports versatile adaptation to the application. Use freely programmable text messages, based on internal or external events, for information, warnings or alerts.

The function also supports actions based on events, for example initiation of a ramp down triggered by a valve opening.

### 12. Advanced minimum speed monitor

Submersible pumps can suffer from insufficient cooling and lubrication when pump speed is too low. The advanced minimum speed monitor protects the pump by monitoring and adjusting the speed to reduce wear and tear. Downtime for maintenance is minimized, with no need for external monitoring equipment.

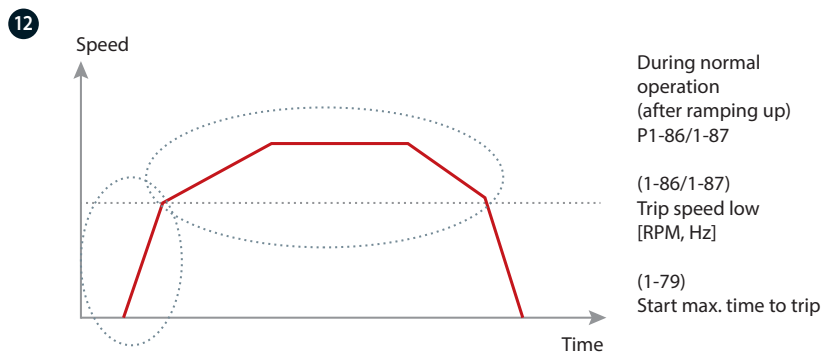
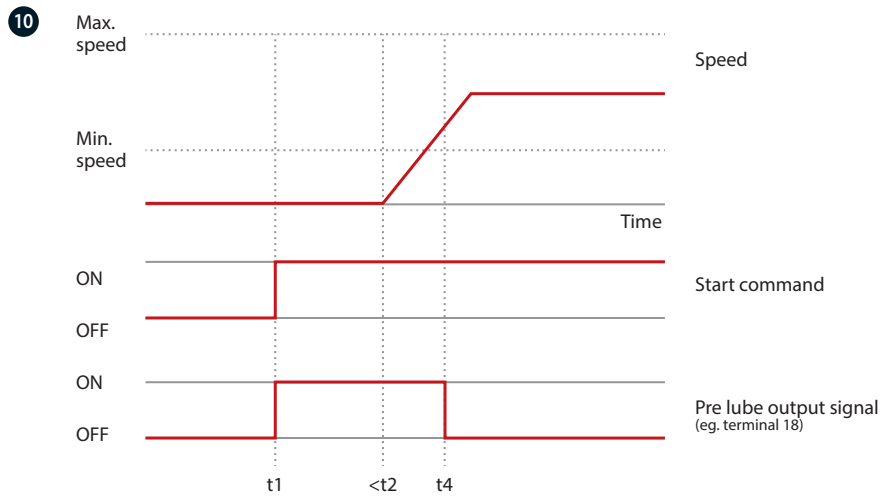

11

Freely programmable texts

<b>Status</b>	1 (1)	
49.3%	0.04 A	0.00 kW
	2.9 Hz	
	0 kWh	
<b>Valve 5 open!</b>		
Auto Remote Ramping		

# Wireless connectivity to the drive

Wireless connection to the drive via your smartphone makes commissioning and trouble-shooting easier and faster when drives are outdoor protected and located in hard-to-access spots.

The VLT® Wireless Communication Panel LCP 103 communicates with MyDrive® Connect – an app which you can download to iOS and Android-based smart devices. MyDrive® Connect gives you full access to the drive, making it easier to perform commissioning, operation, monitoring and maintenance tasks.

## Instant access to vital information

The VLT® Wireless Communication Panel LCP 103 displays the current drive status (On, Warning, Alarm, Wi-Fi Connectivity) through built-in LEDs. Via MCT 10 on a laptop or via the MyDrive® Connect app you can then use your smart device to access detailed information, such as status messages, start-up menus and alarm/warning events. This means you can configure your drive wirelessly on IP55 and

IP66 without compromising the tight enclosure for USB connection.

The app will also visualize various data with graphs to document the behavior of a drive over time. Utilizing the active point-to-point wireless connection, maintenance personnel can receive real-time error messages via the app to enable quick response to potential issues and reduce downtime.

## Sharing data

The advanced LCP copy function allows you to store copies of the drive parameters, either to the internal memory of the VLT® Wireless Communication Panel LCP 103 or to your smart device. Log details can be shared from MyDrive® Connect, so that the service team can provide relevant support for troubleshooting. The safe

control parameter allows the user to decide the drive behavior in case of crash/connection-loss from app to drive.



# Support common fieldbuses

## Increase productivity

With the wide range of fieldbus options the VLT® AQUA Drive can be easily connected to the fieldbus system of your choice. This makes the AQUA Drive a future-ready solution that can easily be expanded and updated if your needs change.

Danfoss fieldbus options can also be installed as a plug-and-play solution at a later stage, if the production layout demands a new communication platform. This way, you can be confident that you can optimize your plant without being forced to replace your existing drive system.

## Download drivers for easy PLC integration

Integrating a drive into an existing bus system can be time consuming and complicated. To make this process easy and more efficient, Danfoss provides all necessary fieldbus drivers and instructions, which can be downloaded free of charge from the Danfoss website.

After installation the bus parameters, typically only a few, can be set directly in the VLT® drive via the local control panel, the VLT® Motion Control Tool MCT 10 or the fieldbus itself.

## Lowest cost of ownership

The VLT® BACnet/IP MCA 125 option is a plug-and-play solution that optimizes the use of VLT® AQUA Drive together with building management systems using the BACnet/IP protocol or running BACnet on Ethernet.

The modular concept of the VLT® AQUA Drive allows you to pay only for features you need, customize your solutions and minimize system costs. The option makes it easy to control or monitor points required in typical water/wastewater applications.

*See the complete list of fieldbuses on page 68.*





## A **masterpiece** of innovation **turns energy consumption** into **energy production**

Advanced process control and extensive use of the VLT® AQUA Drive transform the energy picture of this wastewater treatment plant in Aarhus, Denmark. Transforming the plant from a major energy consumer to a supplier of electricity and district heating, the Marselisborg plant provides a master blueprint that can be emulated around the world.

The considerable daily load variation in water or wastewater treatment plants makes it economically attractive to install drives on all rotating equipment such as pumps, blowers and mixers. The VLT® AQUA Drive is the ideal choice for the water industry, giving you precise control and a perfect match for all your applications.

The operational benefits are obvious:

- Better water quality
- Better asset protection
- Lower maintenance costs
- Lower energy costs
- Higher plant reliability/performance

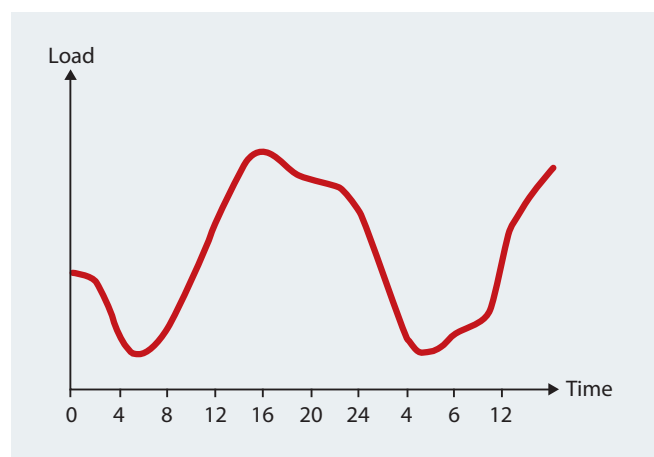



# DrivePro® Life Cycle services

## Delivering a customized service experience!

We understand that every application is different. Having the ability to build a customized service package to suit your specific needs is essential.

DrivePro® Life Cycle Services is a collection of tailor-made products designed around you. Each one engineered to support your business through the different stages of your AC drive's life cycle.

From optimized spare-part packages to condition-monitoring solutions, our products can be customized to help you achieve your business goals.

With the help of these products, we add value to your application by ensuring you get the most out of your AC drive.

When you deal with us, we also offer you access to training, as well as the application knowledge to help you in planning and preparation. Our experts are at your service.

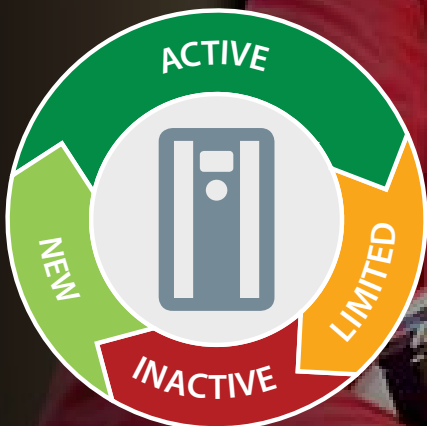



# You're covered

## with DrivePro® Life Cycle service products



### DrivePro® Retrofit

**Minimize the impact and maximize the benefit**

Manage the end of product lifecycle efficiently, with professional help to replace your legacy drives. The DrivePro® Retrofit service ensures optimal uptime and productivity during the smooth replacement process.



### DrivePro® Start-up

**Fine-tune your drive for optimal performance today**

Save on installation and commissioning time and cost. Get help from professional drives experts during start-up, to optimize drives safety, availability and performance.



### DrivePro® Spare Parts

**Plan ahead with your spare part package**

In critical situations, you want no delays. With DrivePro® Spare Parts you always have the right parts on hand, on time. Keep your drives running at top efficiency, and optimize system performance.



### DrivePro® Preventive Maintenance

**Take preventive action**

You receive a maintenance plan and budget, based on an audit of the installation. Then our experts perform the maintenance tasks for you, according to the defined plan.



### DrivePro® Extended Warranty

**Long-term peace of mind**

Get the longest coverage available in the industry, for peace of mind, a strong business case and a stable, reliable budget. You know the annual cost of maintaining your drives, up to six years in advance.



### DrivePro® Remote Expert Support

**You can rely on us every step of the way**

DrivePro® Remote Expert Support offers speedy resolution of on-site issues thanks to timely access to accurate information. With the secure connection, our drives experts analyze issues remotely reducing the time and cost involved in unnecessary service visits.



### DrivePro® Exchange

**The fast, most cost-efficient alternative to repair**

You obtain the fastest, most cost-efficient alternative to repair, when time is critical. You increase uptime, thanks to quick and correct replacement of the drive.



### DrivePro® Remote Monitoring

**Fast resolution of issues**

DrivePro® Remote Monitoring offers you a system that provides online information available for monitoring in real time. It collects all the relevant data and analyzes it so that you can resolve issues before they affect your processes.



### DrivePro® Upgrade

**Maximize your AC drive investment**

Use an expert to replace parts or software in a running unit, so your drive is always up-to-date. You receive an on-site evaluation, an upgrade plan and recommendations for future improvements.

To learn which products are available in your region, please reach out to your local Danfoss Drives sales office or visit our website <http://drives.danfoss.com/danfoss-drives/local-contacts/>

# Connection example

The numbers represent the terminals on the drive

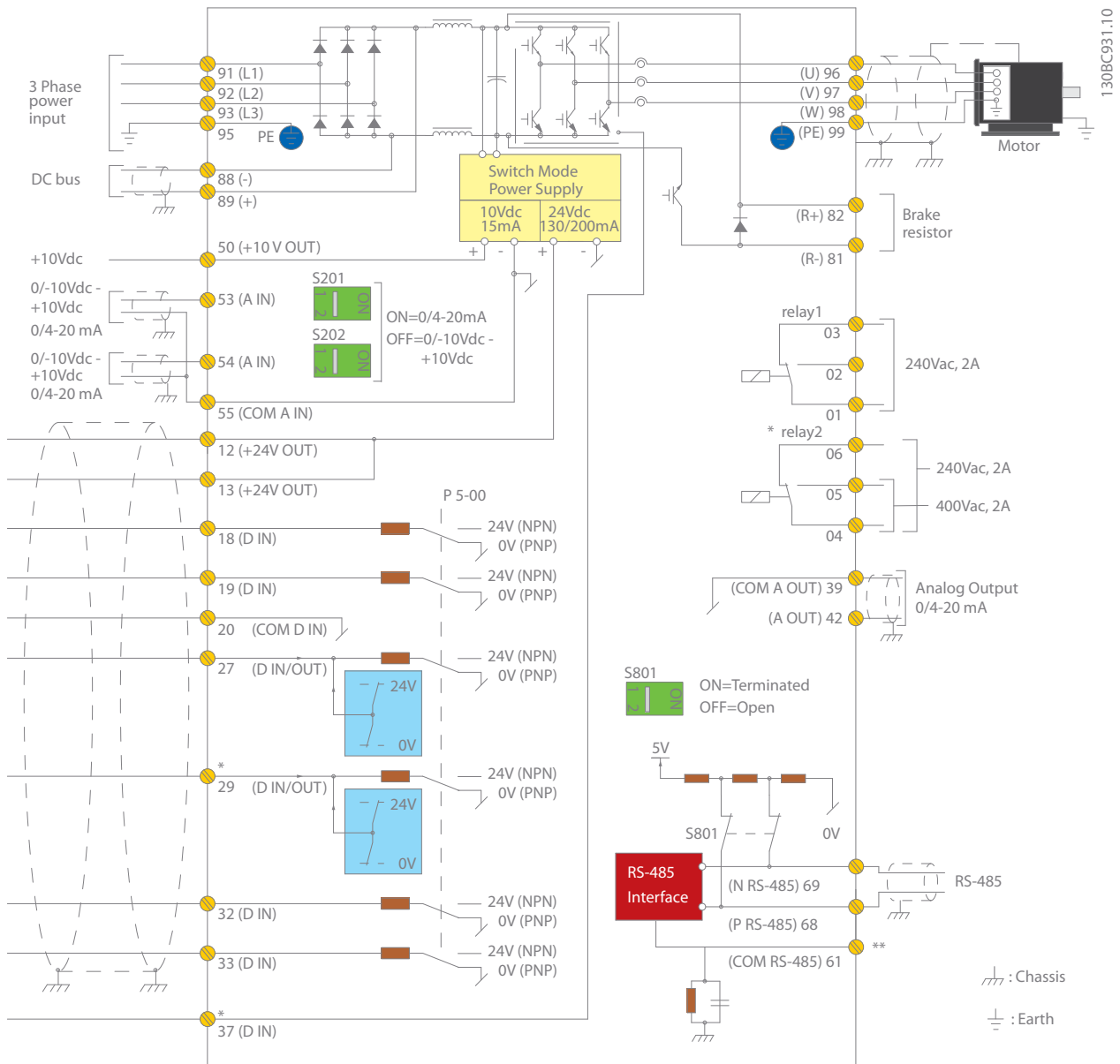

This diagram shows a typical installation of the VLT® AQUA Drive. Power is connected to the terminals 91 (L1), 92 (L2) and 93 (L3) and the motor is connected to 96 (U), 97 (V) and 98 (W).

Terminals 88 and 89 are used for load sharing between drives. Analogue inputs can be connected to the 53 (V or mA), and for 54 (V or mA) terminals.

These inputs can be set up as either reference, feedback or thermistor inputs.

There are 6 digital inputs to be connected to terminals 18, 19, 27, 29, 32, and 33. Two digital input/output terminals (27 and 29) can be set up as digital outputs to show an actual status or warning or can be used as pulse reference signal. The terminal 42 analogue output can show process values such as  $0 - I_{max}$ .

On the 68 (P+) and 69 (N-) terminals' RS 485 interface, the drive can be controlled and monitored via serial communication.

# VLT® AQUA Drive technical data

## Basic unit without extensions

Main supply (L1, L2, L3)	
Supply voltage	1 x 200-240 V AC ..... 1.1-22 kW 1 x 380-480 V AC ..... 7.5-37 kW 3 x 200-240 V AC ..... 0.25-160 kW 3 x 380-480 V AC ..... 0.37-1000 kW 3 x 525-600 V AC ..... 0.75-90 kW 3 x 525-690 V AC ..... 11-1400 kW*
Supply frequency	50/60 Hz
Displacement power factor (cos φ) near unity	> 0.98
True power factor (λ)	≥ 0.9
Switching on input supply L1, L2, L3	1-2 times/min.
Harmonic disturbance	Meets EN 61000-3-12
* Up to 2000 kW available on request	
Output data (U, V, W)	
Output voltage	0 – 100% of supply voltage
Output frequency (dependent on power size)	0-590 Hz
Switching on output	Unlimited
Ramp times	0.1 – 3600 sec.
Note: VLT® AQUA Drive can provide 110%, 150% or 160% current for 1 minute, dependent on power size and parameter settings. Higher overload rating is achieved by oversizing the drive.	
Digital inputs	
Programmable digital inputs	6*
Changeable to digital output	2 (terminal 27, 29)
Logic	PNP or NPN
Voltage level	0-24 V DC
Maximum voltage on input	28 V DC
Input resistance, Ri	Approx. 4 kΩ
Scan interval	5 ms
* Two of the inputs can be used as digital outputs.	
Analog inputs	
Analog inputs	2
Modes	Voltage or current
Voltage level	0 to +10 V (scaleable)
Current level	0/4 to 20 mA (scaleable)
Accuracy of analog inputs	Max. error: 0.5% of full scale
Pulse inputs	
Programmable pulse inputs	2*
Voltage level	0-24 V DC (PNP positive logic)
Pulse input accuracy (0.1-1 kHz)	Max. error: 0.1% of full scale
* Two of the digital inputs can be used for pulse inputs.	
Digital outputs	
Programmable digital/pulse outputs	2
Voltage level at digital/frequency output	0-24 V DC
Max. output current (sink or source)	40 mA
Maximum output frequency at frequency output	0 to 32 kHz
Accuracy on frequency output	Max. error: 0.1% of full scale
Analogue output	
Programmable analogue outputs	1
Current range at analogue output	0/4-20 mA
Max. load to common at analogue output (clamp 30)	500 Ω
Accuracy on analogue output	Max. error: 1% of full scale
Control card	
USB interface	1.1 (Full Speed)
USB plug	Type "B"
RS485 interface	Up to 115 kBaud
Max. load (10 V)	15 mA
Max. load (24 V)	200 mA

Relay output	
Programmable relay outputs	2
Max. terminal load (AC) on 1-3 (break), 1-2 (make), 4-6 (break) power card	240 V AC, 2 A
Max. terminal load (AC) on 4-5 (make) power card	400 V AC, 2 A
Min. terminal load on 1-3 (break), 1-2 (make), 4-6 (break), 4-5 (make) power card	24 V DC 10 mA, 24 V AC 20 mA
Surroundings/external	
Enclosure	IP: 20/21/54/55/66 UL Type: Chassis/1/12/4x Outdoor
Vibration test	1.0 g (D, E & F-enclosures: 0.7 g)
Max. relative humidity	5%-95% (IEC 721-3-3; Class 3K3 (non-condensing) during operation)
Ambient temperature	-25 °C to 50 °C without derating up to 315 kW
Galvanic isolation of all	I/O supplies according to PELV
Aggressive environment	Designed for coated/uncoated 3C3/3C2 (IEC 60721-3-3)
Fieldbus communication	
Standard built-in: FC Protocol Modbus RTU	Optional: VLT® PROFIBUS DP V1 MCA 101 VLT® DeviceNet MCA 104 VLT® PROFINET MCA 120 VLT® EtherNet/IP MCA 121 VLT® Modbus TCP MCA 122 VLT® BACnet/IP MCA 125
Ambient temperature	
Electronic thermal motor protection against overload	
-25 °C to 50 °C without derating up to 315 kW	
Temperature monitoring of the heatsink ensures that the AC drive trips in case of overtemperature	
The AC drive is protected against short-circuits on motor terminals U, V, W	
The AC drive is protected against earth faults on motor terminals U, V, W	
Protection against mains phase loss	
Special version	
Digital Cascade Controller	
Condition based monitoring	
Digital cascade controller + condition based monitoring	
Application options	
Extend the functionality of the drive with integrated options:	
– VLT® General Purpose I/O MCB 101	
– VLT® Extended Cascade Controller MCO 101	
– VLT® Advanced Cascade Controller MCO 102	
– VLT® 24 V External Supply MCB 107	
– VLT® PTC Thermistor Card MCB 112	
– VLT® Extended Relay Card MCB 113	
– VLT® Sensor Input MCB 114	
– VLT® Real-time Clock MCB 117	
Relay and analogue I/O option	
– VLT® Relay Card MCB 105	
– VLT® Analog I/O MCB109)	
Power options	
Choose from a wide range of external power options for use with our drive in critical networks or applications:	
– VLT® Low Harmonic Drive	
– VLT® Advanced Active Filter	
– VLT® Advanced Harmonic Filter	
– VLT® dU/dt filter	
– VLT® Sine wave filter (LC filter)	
High power options	
See the VLT® High Power Drive Selection Guide for a complete list.	
PC software tools	
– VLT® Motion Control Tool MCT 10	
– VLT® Energy Box	
– VLT® Motion Control Tool MCT 31	



# Enclosure overview A, B and C

## 3 phases

VLT® AQUA Drive			T2 200-240 V				T4 380-480 V				T6 525-600 V				T7 525-690 V		
FC 200	kW		IP20	IP21	IP55	IP66	IP20	IP21	IP55	IP66	IP20	IP21	IP55	IP66	IP20	IP21	IP55
	HO	NO															
PK25	0.25																
PK37	0.37																
PK55	0.55																
PK75	0.75		A2	A2	A4/A5	A4/A5											
P1K1	1.1						A2	A2	A4/A5	A4/A5							
P1K5	1.5										A3	A3	A5	A5	A3		
P2K2	2.2																
P3K0	3.0		A3	A3	A5	A5											
P3K7	3.7																
P4K0	4.0						A2	A2	A4/A5								
P5K5	3.7	5.5					A2	A2	A4/A5	A5	A5						
P7K5	5.5	7.5	B3	B1	B1	B1											
P11K	7.5	11					A3	A3	A5	A5							
P15K	11	15	B3	B1	B1	B1											
P18K	15	18.5	B4	B2	B2	B2	B3	B1	B1	B1	B3	B1	B1	B1	B1	B1	B1
P22K	18.5	22															
P30K	22	30	C3	C1	C1	C1											
P37K	30	37					B3	B1	B1	B1	B3	B1	B1	B1	B1	B1	B1
P45K	37	45	B4	B2	B2	B2	B4	B2	B2	B2	B4	B2	B2	B2	B2	B2	B2
P55K	45	55															
P75K	55	75															
P90K	75	90															

## 1 phase

VLT® AQUA Drive		S2 200-240 V				S4 380-480 V		
FC 200	kW	IP20	IP21	IP55	IP66	IP21	IP55	IP66
P1K1	1.1	A3		A5	A5			
P1K5	1.5							
P2K2	2.2							
P3K0	3.0		B1	B1	B1			
P3K7	3.7							
P5K5	5.5							
P7K5	7.5		B2	B2	B2	B1	B1	B1
P11K	11							
P15K	15		C1	C1	C1	B2	B2	B2
P18K	18.5							
P22K	22		C2	C2	C2	C1	C1	C1
P37K	37							

- IP20/Chassis
- IP21/Type 1
- IP21 with upgrade kit  
– available in North America only
- IP55/Type 12
- IP66/NEMA 4X



# Electrical data – A, B and C enclosures

## [S2] 1 x 200-240 V AC – normal overload

Normal overload (110% 1 min/10 min)							Enclosure size			
Type code	Output current (3 x 200-240 V)		Typical shaft output power		Continuous input current	Estimated power loss	Protection rating [IEC/UL]			
	FC-202	Con. I <sub>N</sub>	Inter. I <sub>MAX</sub> (60 s)	kW @ 208 V			Hp @ 230 V	[A]	[W]	IP20
								Chassis	Type 1	Type 12
P1K1	6.6	7.3	1.1	12.5	1.5	44	A3	–	A5	A5
P1K5	7.5	8.3	1.5	15	2.0	30	–	B1	B1	B1
P2K2	10.6	11.7	2.2	21	2.9	44	–	B1	B1	B1
P3K0	12.5	13.8	3	24	4.0	60	–	B1	B1	B1
P3K7	16.7	18.4	3.7	32	4.9	74	–	B1	B1	B1
P5K5	24.2	26.6	5.5	46.0	7.5	110	–	B1	B1	B1
P7K5	30.8	33.4	7.5	59	10	150	–	B2	B2	B2
P15K	59.4	65.3	15	111	20	300	–	C1	C1	C1
P22K	88	96.8	22	172	30	440	–	C2	C2	C2

## [T2] 3 x 200-240 V AC – normal overload

Normal overload (110% 1 min/10 min)							Enclosure size			
Type code	Output current (3 x 200-240 V)		Typical shaft output power		Continuous input current	Estimated power loss	Protection rating [IEC/UL]			
	FC-202	Con. I <sub>N</sub>	Inter. I <sub>MAX</sub> (60 s)	kW @ 208 V			Hp @ 230V	[A]	[W]	IP20/21
								Chassis	Type 1	Type 12
PK25	1.8	2	0.25	0.34	1.6	21	A2	A2*	A4/A5**	A4/A5**
PK37	2.4	2.6	0.37	0.5	2.2	29	A2	A2*	A4/A5**	A4/A5**
PK55	3.5	3.9	0.55	0.75	3.2	42	A2	A2*	A4/A5**	A4/A5**
PK75	4.6	5.1	0.75	1	4.1	54	A2	A2*	A4/A5**	A4/A5**
P1K1	6.6	7.3	1.1	1.5	5.9	63	A2	A2*	A4/A5**	A4/A5**
P1K5	7.5	8.3	1.5	2	6.8	82	A2	A2*	A4/A5**	A4/A5**
P2K2	10.6	11.7	2.2	3	9.5	116	A2	A2*	A4/A5**	A4/A5**
P3K0	12.5	13.8	3	4	11.3	155	A3	A3*	A5	A5
P3K7	16.7	18.4	3.7	5	15	185	A3	A3*	A5	A5
P5K5	24.2	26.6	5.5	7.5	22	310	B3	B1	B1	B1
P7K5	30.8	33.9	7.5	10	28	310	B3	B1	B1	B1
P11K	46.2	50.8	11	15	42	514	B3	B1	B1	B1
P15K	59.4	65.3	15	20	54	602	B4	B2	B2	B2
P18K	74.8	82.3	18.5	25	68	737	B4	C1	C1	C1
P22K	88	96.8	22	30	80	845	C3	C1	C1	C1
P30K	115	127	30	40	104	1140	C3	C1	C1	C1
P37K	143	157	37	50	130	1353	C4	C2	C2	C2
P45K	170	187	45	60	154	1636	C4	C2	C2	C2

\* Requires an IP21/Type 1 kit. Available in North America only.

\*\* A4 does not accept any C options



## [T2] 3 x 200-240 V AC – high overload

Type code	High overload (160% 1 min/10 min)						Enclosure size			
	Output current (3 x 200-240 V)		Typical shaft output power		Continuous input current	Estimated power loss	Protection rating [IEC/UL]			
	Con. I <sub>N</sub>	Inter. I <sub>MAX</sub> (60 s)	kW @ 208 V	Hp @ 230 V			IP20/21	IP21	IP55	IP66
FC-202	Con. I <sub>N</sub>	Inter. I <sub>MAX</sub> (60 s)	kW @ 208 V	Hp @ 230 V	[A]	[W]	Chassis	Type 1	Type 12	Type 4X
PK25	1.8	2.7	0.25	0.34	1.6	21	A2	A2*	A4/A5**	A4/A5**
PK37	2.4	3.6	0.37	0.5	2.2	29	A2	A2*	A4/A5**	A4/A5**
PK55	3.5	5.3	0.55	0.75	3.2	42	A2	A2*	A4/A5**	A4/A5**
PK75	4.6	6.9	0.75	1	4.1	54	A2	A2*	A4/A5**	A4/A5**
P1K1	6.6	9.9	1.1	1.5	5.9	63	A2	A2*	A4/A5**	A4/A5**
P1K5	7.5	11.3	1.5	2	6.8	82	A2	A2*	A4/A5**	A4/A5**
P2K2	10.6	15.9	2.2	3	9.5	116	A2	A2*	A4/A5**	A4/A5**
P3K0	12.5	18.8	3	4	11.3	155	A3	A3*	A5	A5
P3K7	16.7	25	3.7	5	15.0	185	A3	A3*	A5	A5
P5K5	16.7	26.7	3.7	5	15.0	239	B3	B1	B1	B1
P7K5	24.2	38.7	5.5	7.5	22	239	B3	B1	B1	B1
P11K	30.8	49.3	7.5	10	28	371	B3	B1	B1	B1
P15K	46.2	73.9	11	15	42	463	B4	B2	B2	B2
P18K	59.4	89.1	15	20	54	624	B4	C1	C1	C1
P22K	74.8	112	18.5	25	68	740	C3	C1	C1	C1
P30K	88	132	22	30	80	874	C3	C1	C1	C1
P37K	115	173	30	40	104	1143	C4	C2	C2	C2
P45K	143	215	37	50	130	1400	C4	C2	C2	C2

\* Requires an IP21/Type 1 kit. Available in North America only.

\*\* A4 does not accept any C options

## [S4] 1 x 380-480 V AC – normal overload

Type code	Normal overload (110% 1 min/10 min)							Enclosure size				
	Output current				Typical shaft output power		Continuous input current	Estimated power loss	Protection rating [IEC/UL]			
	(3 x 380-440 V)		(3 x 441-480 V)		kW @ 400 V	Hp @ 460 V			IP20/21	IP21	IP55	IP66
FC-202	Con. I <sub>N</sub>	Inter. I <sub>MAX</sub> (60 s)	Con. I <sub>N</sub>	Inter. I <sub>MAX</sub> (60 s)			kW @ 400 V	Hp @ 460 V	[A] @ 400 V	[W]	Chassis	Type 1
P7K5	16	17.6	14.5	15.4	7.5	10	33	300	-	B1	B1	B1
P11K	24	26.4	21	23.1	11	15	48	440	-	B2	B2	B2
P18K	37.5	41.2	34	37.4	18.5	25	78	740	-	C1	C1	C1
P37K	73	80.3	65	71.5	37	50	151	1480	-	C2	C2	C2

### [T4] 3 x 380-480 V AC – normal overload

Type code	Normal overload (110% 1 min/10 min)							Enclosure size				
	Output current				Typical shaft output power	Continu-ous input current	Estimated power loss	Protection rating [IEC/UL]				
	(3 x 380-440 V)		(3 x 441-500 V)					IP20/21	IP21	IP55	IP66	
FC-202	Con. I <sub>N</sub>	Inter. I <sub>MAX</sub> (60 s)	Con. I <sub>N</sub>	Inter. I <sub>MAX</sub> (60 s)	kW @ 400 V	Hp @ 460 V	[A] @ 400 V	[W]	Chassis	Type 1	Type 12	Type 4X
PK37	1.3	1.4	1.2	1.3	0.37	0.5	1.2	35	A2	A2*	A4/A5**	A4/A5**
PK55	1.8	2	1.6	1.8	0.55	0.75	1.6	42	A2	A2*	A4/A5**	A4/A5**
PK75	2.4	2.6	2.1	2.3	0.75	1	2.2	46	A2	A2*	A4/A5**	A4/A5**
P1K1	3	3.3	2.7	3	1.1	1.5	2.7	58	A2	A2*	A4/A5**	A4/A5**
P1K5	4.1	4.5	3.4	3.7	1.5	2	3.7	62	A2	A2*	A4/A5**	A4/A5**
P2K2	5.6	6.2	4.8	5.3	2.2	3	5.0	88	A2	A2*	A4/A5**	A4/A5**
P3K0	7.2	7.9	6.3	6.9	3	4	6.5	116	A2	A2*	A4/A5**	A4/A5**
P4K0	10	11	8.2	9	4	5	9.0	124	A2	A2*	A4/A5**	A4/A5**
P5K5	13	14.3	11	12.1	5.5	7.5	11.7	187	A3	A3*	A5	A5
P7K5	16	17.6	14.5	16	7.5	10	14.4	225	A3	A3*	A5	A5
P11K	24	26.4	21	23.1	11	15	22	392	B3	B1	B1	B1
P15K	32	35.2	27	29.7	15	20	29	392	B3	B1	B1	B1
P18K	37.5	41.3	34	37.4	18.5	25	34	465	B3	B1	B1	B1
P22K	44	48.4	40	44	22	30	40	525	B4	B2	B2	B2
P30K	61	67.1	52	61.6	30	40	55	739	B4	B2	B2	B2
P37K	73	80.3	65	71.5	37	50	66	698	B4	C1	C1	C1
P45K	90	99	80	88	45	60	82	843	C3	C1	C1	C1
P55K	106	117	105	116	55	75	96	1083	C3	C1	C1	C1
P75K	147	162	130	143	75	100	133	1384	C4	C2	C2	C2
P90K	177	195	160	176	90	125	161	1474	C4	C2	C2	C2

\* Requires an IP21/Type 1 kit. Available in North America only.  
 \*\* A4 does not accept any C options

### [T4] 3 x 380-480 V AC – high overload

Type code	High overload (160% 1 min/10 min)							Enclosure size				
	Output current				Typical shaft output power	Continu-ous input current	Estimated power loss	Protection rating [IEC/UL]				
	(3 x 380-440 V)		(3 x 441-500 V)					IP20/21	IP21	IP55	IP66	
FC-202	Con. I <sub>N</sub>	Inter. I <sub>MAX</sub> (60 s)	Con. I <sub>N</sub>	Inter. I <sub>MAX</sub> (60 s)	kW @ 400 V	Hp @ 460 V	[A] @ 400 V	[W]	Chassis	Type 1	Type 12	Type 4X
PK37	1.3	2	1.2	1.8	0.37	0.5	1.2	35	A2	A2*	A4/A5**	A4/A5**
PK55	1.8	2.7	1.6	2.4	0.55	0.75	1.6	42	A2	A2*	A4/A5**	A4/A5**
PK75	2.4	3.6	2.1	3.2	0.75	1	2.2	46	A2	A2*	A4/A5**	A4/A5**
P1K1	3	4.5	2.7	4.1	1.1	1.5	2.7	58	A2	A2*	A4/A5**	A4/A5**
P1K5	4.1	6.2	3.4	5.1	1.5	2	3.7	62	A2	A2*	A4/A5**	A4/A5**
P2K2	5.6	8.4	4.8	7.2	2.2	3	5.0	88	A2	A2*	A4/A5**	A4/A5**
P3K0	7.2	10.8	6.3	9.5	3	4	6.5	116	A2	A2*	A4/A5**	A4/A5**
P4K0	10	15	8.2	12.3	4	5	9.0	124	A2	A2*	A4/A5**	A4/A5**
P5K5	13	19.5	11	16.5	5.5	7.5	11.7	187	A3	A3*	A5	A5
P7K5	16	24	14.5	21.8	7.5	10	14.4	225	A3	A3*	A5	A5
P11K	16	25.6	14.5	23.2	7.5	10	14	291	B3	B1	B1	B1
P15K	24	38.4	21	33.6	11	15	22	291	B3	B1	B1	B1
P18K	32	51.2	27	43.2	15	20	29	379	B3	B1	B1	B1
P22K	37.5	60	34	54.4	18.5	25	34	444	B4	B2	B2	B2
P30K	44	70.4	40	64	22	30	40	547	B4	B2	B2	B2
P37K	61	91.5	52	78	30	40	55	570	B4	C1	C1	C1
P45K	73	110	65	97.5	37	50	66	697	C3	C1	C1	C1
P55K	90	135	80	120	45	60	82	891	C3	C1	C1	C1
P75K	106	159	105	158	55	75	96	1022	C4	C2	C2	C2
P90K	147	221	130	195	75	100	133	1232	C4	C2	C2	C2

\* Requires an IP21/Type 1 kit. Available in North America only.  
 \*\* A4 does not accept any C options

## [T6] 3 x 525-600 V AC – normal overload

Type code	Normal overload (110% 1 min/10 min)						Enclosure size			
	Output current (3 x 525-600 V)		Typical shaft output power		Continuous input current [A] @ 575 V	Estimated power loss [W]	Protection rating [IEC/UL]			
	Con. I <sub>N</sub>	Inter. I <sub>MAX</sub> (60 s)	kW @ 575 V	Hp @ 575 V			IP20/21	IP21	IP55	IP66
FC-202	Con. I <sub>N</sub>	Inter. I <sub>MAX</sub> (60 s)	kW @ 575 V	Hp @ 575 V	[A] @ 575 V	[W]	Chassis	Type 1	Type 12	Type 4X
PK75	1.7	1.9	0.75	1	1.7	35	A3	A3	A5	A5
P1K1	2.4	2.6	1.1	1.5	2.4	50	A3	A3	A5	A5
P1K5	2.7	3	1.5	2	2.7	65	A3	A3	A5	A5
P2K2	3.9	4.3	2.2	3	4.1	92	A3	A3	A5	A5
P3K0	4.9	5.4	3	4	5.2	122	A3	A3	A5	A5
P4K0	6.1	6.7	4	5	5.8	145	A3	A3	A5	A5
P5K5	9	9.9	5.5	7.5	8.6	195	A3	A3	A5	A5
P7K5	11	12.1	7.5	10	10.4	261	A3	A3	A5	A5
P11K	18	20	11	15	16	300	B3	B1	B1	B1
P15K	22	24	15	20	20	300	B3	B1	B1	B1
P18K	27	30	18.5	25	24	370	B3	B1	B1	B1
P22K	34	37	22	30	31	440	B4	B2	B2	B2
P30K	41	45	30	40	37	600	B4	B2	B2	B2
P37K	52	57	37	50	47	740	B4	C1	C1	C1
P45K	62	68	45	60	56	900	C3	C1	C1	C1
P55K	83	91	55	75	75	1100	C3	C1	C1	C1
P75K	100	110	75	100	91	1500	C4	C2	C2	C2
P90K	131	144	90	125	119	1800	C4	C2	C2	C2

## [T6] 3 x 525-600 V AC – high overload

Type code	High overload (160% 1 min/10 min)						Enclosure size			
	Output current (3 x 525-600 V)		Typical shaft output power		Continuous input current [A] @ 575 V	Estimated power loss [W]	Protection rating [IEC/UL]			
	Con. I <sub>N</sub>	Inter. I <sub>MAX</sub> (60 s)	kW @ 575 V	Hp @ 575 V			IP20/21	IP21	IP55	IP66
FC-202	Con. I <sub>N</sub>	Inter. I <sub>MAX</sub> (60 s)	kW @ 575 V	Hp @ 575 V	[A] @ 575 V	[W]	Chassis	Type 1	Type 12	Type 4X
PK75	1.7	2.6	0.75	1	1.7	35	A3	A3	A5	A5
P1K1	2.4	3.6	1.1	1.5	2.4	50	A3	A3	A5	A5
P1K5	2.7	4.1	1.5	2	2.7	65	A3	A3	A5	A5
P2K2	3.9	5.9	2.2	3	4.1	92	A3	A3	A5	A5
P3K0	4.9	7.4	3	4	5.2	122	A3	A3	A5	A5
P4K0	6.1	9.2	4	5	5.8	145	A3	A3	A5	A5
P5K5	9	13.5	5.5	7.5	8.6	195	A3	A3	A5	A5
P7K5	11	16.5	7.5	10	10.4	261	A3	A3	A5	A5
P11K	11	17.6	7.5	10	9.8	220	B3	B1	B1	B1
P15K	18	29	11	15	16	220	B3	B1	B1	B1
P18K	22	35	15	20	20	300	B3	B1	B1	B1
P22K	27	43	18.5	25	24	370	B4	B2	B2	B2
P30K	34	54	22	30	31	440	B4	B2	B2	B2
P37K	41	62	30	40	37	600	B4	C1	C1	C1
P45K	52	78	37	50	47	740	C3	C1	C1	C1
P55K	62	93	45	60	56	900	C3	C1	C1	C1
P75K	83	125	55	75	75	1100	C4	C2	C2	C2
P90K	100	150	75	100	91	1500	C4	C2	C2	C2

## [T7] 3 x 525-690 V AC – normal overload

Type code	Normal overload (110% 1 min/10 min)								Enclosure size		
	Output current				Typical shaft output power		Continuous input current	Estimated power loss	Protection rating [IEC]*		
	(3 x 525-550 V)		(3 x 551-690 V)								
FC-202	Con. I <sub>N</sub>	Inter. I <sub>MAX</sub> (60 s)	Con. I <sub>N</sub>	Inter. I <sub>MAX</sub> (60 s)	kW @ 690 V	Hp @ 575 V	[A] @ 690 V	[W]	IP20	IP21	IP55
P1K1	2.1	2.3	1.6	1.8	1.1	1.5	1.4	44	A3	-	-
P1K5	2.7	3	2.2	2.4	1.5	2	2.0	60	A3	-	-
P2K2	3.9	4.3	3.2	3.5	2.2	3	2.9	88	A3	-	-
P3K0	4.9	5.4	4.5	5	3	4	4.0	120	A3	-	-
P4K0	6.1	6.7	5.5	6.1	4	5	4.9	160	A3	-	-
P5K5	9	9.9	7.5	8.3	5.5	7.5	6.7	220	A3	-	-
P7K5	11	12.1	10	11	7.5	10	9.0	300	A3	-	-
P11K	14	15.4	13	14.3	11	15	14.5	220	B4	B2	B2
P15K	19	20.9	18	19.8	15	20	19.5	220	B4	B2	B2
P18K	23	25.3	22	24.2	18.5	25	24	300	B4	B2	B2
P22K	28	30.8	27	29.7	22	30	29	370	B4	B2	B2
P30K	36	39.6	34	37.4	30	40	36	440	B4	B2	B2
P37K	43	47.3	41	45.1	37	50	48	740	B4	C2	C2
P45K	54	59.4	52	57.2	45	60	58	900	C3	C2	C2
P55K	65	71.5	62	68.2	55	75	70	1100	C3	C2	C2
P75K	87	95.7	83	91.3	75	100	86	1500	-	C2	C2
P90K	105	115.5	100	110	90	125		1800	-	C2	C2

\*Note: T7 drives are not UL certified. Select T6 for UL certification.

## [T7] 3 x 525-690 V AC – high overload

Type code	High overload (160% 1 min/10 min)								Enclosure size		
	Output current				Typical shaft output power		Continuous input current	Estimated power loss	Protection rating [IEC]*		
	(3 x 525-550 V)		(3 x 551-690 V)								
FC-202	Con. I <sub>N</sub>	Inter. I <sub>MAX</sub> (60 s)	Con. I <sub>N</sub>	Inter. I <sub>MAX</sub> (60 s)	kW @ 690 V	Hp @ 575 V	[A] @ 690 V	[W]	IP20	IP21	IP55
P1K1	2.1	3.2	1.6	2.4	1.1	1.5	1.4	44	A3	-	-
P1K5	2.7	4.1	2.2	3.3	1.5	2	2.0	60	A3	-	-
P2K2	3.9	5.9	3.2	4.8	2.2	3	2.9	88	A3	-	-
P3K0	4.9	7.4	4.5	6.8	3	4	4.0	120	A3	-	-
P4K0	6.1	9.2	5.5	8.3	4	5	4.9	160	A3	-	-
P5K5	9	13.5	7.5	11.3	5.5	7.5	6.7	220	A3	-	-
P7K5	11	16.5	10	15	7.5	10	9.0	300	A3	-	-
P11K	11	17.6	10	16	7.5	10	9.0	150	B4	B2	B2
P15K	14	22.4	13	20.8	11	15	14.5	150	B4	B2	B2
P18K	19	30.4	18	28.8	15	20	19.5	220	B4	B2	B2
P22K	23	36.8	22	35.2	18.5	25	24	300	B4	B2	B2
P30K	28	44.8	27	43.2	22	30	29	370	B4	B2	B2
P37K	36	54	34	51	30	40	36	600	B4	C2	C2
P45K	43	64.5	41	61.5	37	50	48	740	C3	C2	C2
P55K	54	81	52	78	45	60	58	900	C3	C2	C2
P75K	65	97.5	62	93	55	75	70	1100	-	C2	C2
P90K	87	130.5	83	124.5	75	100		1500	-	C2	C2

\*Note: T7 drives are not UL certified. Select T6 for UL certification.



## Dimensions enclosure sizes A, B and C

Enclosure size		VLT® AQUA Drive													
		A2		A3		A4	A5	B1	B2	B3	B4	C1	C2	C3	C4
Protection rating [IEC/UL]		IP20 Chassis	IP21 Type 1	IP20 Chassis	IP21 Type 1	IP55/Type 12 IP66/Type 4X	IP21/Type 1 IP55/Type 12 IP66/Type 4X	IP21/Type 1 IP55/Type 12 IP66/Type 4X	IP20/Chassis	IP20/Chassis	IP21/Type 1 IP55/Type 12 IP66/Type 4X	IP21/Type 1 IP55/Type 12 IP66/Type 4X	IP20/Chassis	IP20/Chassis	
[mm]	Height	268	375	268	375	390	420	480	650	399	520	680	770	550	660
	Height with decoupling plate	374	–	374	–	–	–	–	–	420	595	–	–	630	800
	Width	90	90	130	130	200	242	242	242	165	230	308	370	308	370
	Width with one C option	130	130	170	170	–	242	242	242	205	230	308	370	308	370
	Depth	205	207	205	207	175	200	260	260	249	242	310	335	333	333
	Depth with A, B option	220	222	220	222	175	200	260	260	262	242	310	335	333	333
	Depth with mains disconnect	–	–	–	–	206	224	289	290	–	–	344	378	–	–
[kg]	Weight	4.9	5.3	6	7	9.7	14.2	23	27	12	23.5	45	64	35	50
[in]	Height	10.6	14.8	10.6	14.8	15.4	16.6	18.9	25.6	15.8	20.5	26.8	30.4	21.7	26
	Height with decoupling plate	14.8	–	14.8	–	–	–	–	–	16.6	23.5	–	–	24.8	31.5
	Width	3.6	3.6	5.2	5.2	7.9	9.6	9.6	9.6	6.5	9.1	12.2	14.6	12.2	14.6
	Width with one C option	5.2	5.2	6.7	6.7	–	9.6	9.6	9.6	8.1	9.1	12.2	14.6	12.2	14.6
	Depth	8.1	18.2	8.1	8.2	6.9	7.9	10.3	10.3	9.8	9.6	12.3	13.2	13	13
	Depth with mains disconnect	–	–	–	–	8.2	8.9	11.4	11.5	–	–	13.6	14.9	–	–
	Depth with A, B option	8.7	8.8	8.7	8.8	6.9	7.9	10.3	10.3	10.4	9.6	12.3	13.2	13	13
[lb]	Weight	10.8	11.7	14.6	15.5	21.5	31.5	50.7	59.6	26.5	52	99.3	143.3	77.2	110.2

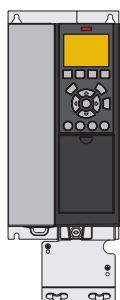

A3 IP20/Chassis with decoupling plate

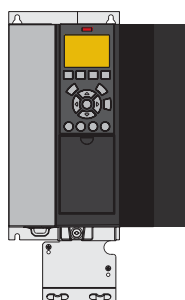

A3 IP20 with option C

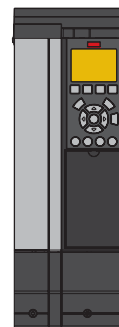

A3 with IP21/Type 12 NEMA 1 Kit



A4 IP55 with mains disconnect

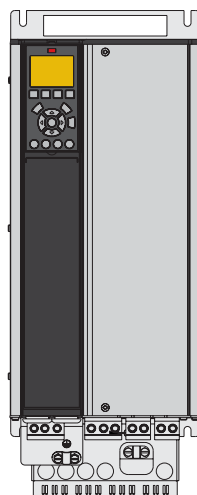

B4 IP20

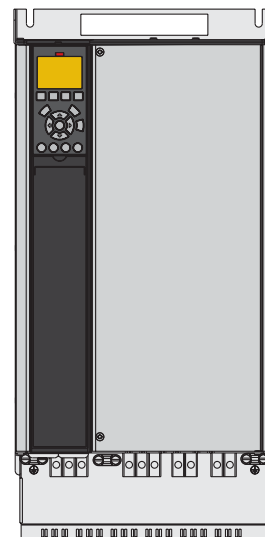

C3 IP20

# Ordering **typecode** for **A, B** and **C** enclosures



<b>[1] Application</b> (character 4-6)	
202	VLT® AQUA Drive FC 202
<b>[2] Power size</b> (character 7-10)	
PK25	0.25 kW/0.33 Hp
PK37	0.37 kW/0.50 Hp
PK55	0.55 kW/0.75 Hp
PK75	0.75 kW/1.0 Hp
P1K1	1.1 kW/1.5 Hp
P1K5	1.5 kW/2.0 Hp
P2K2	2.2 kW/3.0 Hp
P3K0	3.0 kW/4.0 Hp
P3K7	3.7 kW/5.0 Hp
P4K0	4.0 kW/5.5 Hp
P5K5	5.5 kW/7.5 Hp
P7K5	7.5 kW/10 Hp
P11K	11 kW/15 Hp
P15K	15 kW/20 Hp
P18K	18.5 kW/25 Hp
P22K	22 kW/30 Hp
P30K	30 kW/40 Hp
P37K	37 kW/50 Hp
P45K	45 kW/60 Hp
P55K	55 kW/75 Hp
P75K	75 kW/100 Hp
P90K	90 kW/125 Hp
<b>[3] AC Line Voltage</b> (character 11-12)	
S2	1 x 200/240 V AC
T2	3 x 200-240 V AC
S4	1 x 380/480 V AC
T4	3 x 380-480 V AC
T6	3 x 525-600 V AC
T7	3 x 525-690 V AC <sup>2)</sup>
<b>[4] IP/UL protection ratings</b> (character 13-15)	
<b>IP20 / Chassis enclosures</b>	
E20	IP20/Chassis
P20	IP20/Chassis + backplate
<b>IP21 / UL Type 1 enclosures</b>	
E21	IP21 / Type 1
P21	IP21 / Type 1 + backplate
<b>IP55 / UL Type 12 enclosures</b>	
E55	IP55/Type 12
P55	IP55/Type 12 + backplate
Y55	IP55/Type 12 + backplate (A4 enclosure, no C-options)
Z55	IP55/Type 12 (A4 enclosure, no C-options)
<b>UL Type 3R enclosures</b>	
E3R	UL Type 3R (North America only)
P3R	UL Type 3R + backplate (North America only)
<b>IP66 / UL Type 4X enclosures</b>	
E66	IP66/Type 4X
Y66	IP66/Type 4X + backplate (A4 enclosure, no C-options)
Z66	IP66/Type 4X (A4 enclosure, no C-options)

<b>[5] RFI filter, terminal and monitoring options</b> – EN/IEC 61800-3 (character 16-17)	
H1	RFI-Filter Class A1/B (C1)
H2	RFI-Filter, Class A2 (C3)
H3	RFI-Filter Class A1/B <sup>1)</sup>
H4	RFI-Filter, Class A1 (C2)
H5	RFI-Filter, Class A2 (C3) Marine ruggedized
HX	No RFI-Filter
<b>[6] Braking and safety</b> (character 18)	
X	No brake IGBT
B	Brake IGBT
T	Safe Stop without brake
U	Brake IGBT plus Safe Torque Off
<b>[7] LCP Display</b> (character 19)	
X	Blank faceplate, no LCP installed
N	Numerical Local Control Panel (LCP 101)
G	Graphical Local Control Panel (LCP 102)
W	VLT® Wireless Communication Panel LCP 103
<b>[8] PCB Coating – IEC 721-3-3</b> (character 20)	
X	Standard coated PCB Class 3C2
C	Coated PCB Class 3C3
<b>[9] Mains input</b> (character 21)	
X	No mains option
1	Mains disconnect (A4, A5, B1, B2, C1 and C2 enclosures only)
8	Mains disconnect and load sharing (B1, B2, C1 and C2 enclosures only)
D	Load sharing terminals (B1, B2, C1, C2 enclosures only)
<b>[10] Hardware option A</b> (character 22)	
X	Standard cable entries
O	Metric cable entry (threaded)
S	Imperial cable entry
<b>[11] Hardware option B</b> (character 23)	
X	No adaptation
<b>[12] Special version</b> (character 24-27)	
SXXX	Latest released standard software
LXX1	Digital Cascade Controller
LX1X	Condition based monitoring
LX11	Digital Cascade Controller + conditional based monitoring
<b>[13] LCP language</b> (character 28)	
X	Standard language package including English, German, French, Spanish, Danish, Italian, Finnish and others
<b>Contact factory for other language options</b>	
<b>[14] A-options: Fieldbus</b> (character 29-30)	
AX	No option
A0	VLT® PROFIBUS DP V1 MCA 101
A4	VLT® DeviceNet MCA 104
AL	VLT® PROFINET MCA 120
AN	VLT® EtherNet/IP MCA 121
AQ	VLT® Modbus TCP MCA 122
AK	VLT® BACnet/IP MCA 125

<b>[15] B-options</b> (character 31-32)	
BX	No option
BK	VLT® General Purpose MCB 101
BP	VLT® Relay Option MCB 105
B2	VLT® PTC Thermistor Card MCB 112
B4	VLT® Sensor Input Card MCB 114
BY	VLT® Extended Cascade Controller MCO 101
<b>[16] C0-option</b> (character 33-34)	
CX	No option
<b>[17] C1-option</b> (character 35)	
X	No option
5	VLT® Advanced Cascade Controller MCO 102
R	VLT® Extended Relay Card MCB 113
<b>[18] C1-option software</b> (character 36-37)	
XX	No software option
<b>[19] D-option</b> (character 38-39)	
DX	No DC input installed
D0	VLT® 24 V DC Supply Option MCB 107
D1	VLT® Real-time Clock Option MCB 117

1) Reduced motor cable length

2) Note: T7 drives are not UL certified.  
Select T6 for UL certification.

Please beware that not all combinations are possible.  
Find help configuring your drive with the online  
configurator found under: [driveconfig.danfoss.com](https://driveconfig.danfoss.com)

# Enclosure overview D, E and F

## 6-pulse

VLT® AQUA Drive			T2 3 x 200-240 V			T4 380-480 V			T7 525-690 V		
FC 200	kW		IP20	IP21	IP54	IP20	IP21	IP54	IP20	IP21	IP54
	NO	HO									
N55K	55	45	D3h	D1h	D1h						
N75K	75	55									
N90K	90	75									
N110	110	90									
N132	132	110	D4h	D2h	D2h	D3h	D1h D5h D6h	D1h D5h D6h	D3h	D1h D5h D6h	D1h D5h D6h
N160	160	132									
N200	200	160									
N250	250	200				D4h	D2h D7h D8h	D2h D7h D8h	D4h	D2h D7h D8h	D2h D7h D8h
N315	315	250									
N355	355	315									
N400	400	355				E3h	E1h	E1h	D4h	D2h D7h D8h	D2h D7h D8h
N450	450	400									
N500	500	450				E4h	E2h	E2h	E3h	E1h	E1h
N560	560	500									
N630	630	560									
N710	710	630							E4h	E2h	E2h
N800	800	710									
P500	500	450									
P560	560	500									
P630	630	560					F1/F3	F1/F3			
P710	710	630									
P800	800	710					F2/F4	F2/F4	F1/F3	F1/F3	
P900	900	800									
P1M0	1000	900					F2/F4	F2/F4			
P1M2	1200	1000							F2/F4	F2/F4	
P1M4	1400	1200									

## 12-pulse

VLT® AQUA Drive			T4 380-480 V				T7 525-690 V			
FC 200	kW		IP21	IP21 + options	IP54	IP54 + options	IP21	IP21 + options	IP54	IP54 + options
	NO	HO								
P315	315	250								
P355	355	315	F8	F9	F8	F9				
P400	400	355								
P450	450	400								
P500	500	450								
P560	560	500					F8	F9	F8	F9
P630	630	560	F10	F11	F10	F11				
P710	710	630								
P800	800	710	F12	F13	F12	F13	F10	F11	F10	F12
P900	900	800								
P1M0	1000	800	F12	F13	F12	F13				
P1M2	1200	1000					F12	F13	F12	F13
P1M4	1400	1200								

- IP20/Chassis
- IP21/Type 1
- IP54/Type 12



# Electrical data – D, E and F enclosures

## [T2] 3 x 200-240 V AC – normal overload

Type code	Normal overload (110% 1 min/10 min)						Enclosure size		
	Output current (3 x 200-240 V)		Typical shaft output power		Continuous input current	Estimated power loss	Protection rating [IEC/UL]		
	Con. I <sub>N</sub>	Inter. I <sub>MAX</sub> (60 s)	kW	HP @ 230 V	[A]	[W]	IP20	IP21	IP54
FC-202	Con. I <sub>N</sub>	Inter. I <sub>MAX</sub> (60 s)	kW	HP @ 230 V	[A]	[W]	Chassis	Type 1	Type 12
N55K	190	209	55	75	183	1505	D3h	D1h	
N75K	240	264	75	100	231	2398	D3h	D1h	
N90K	302	332	90	120	291	2623	D4h	D2h	
N110	361	397	110	150	348	3284	D4h	D2h	
N150	443	487	150	200	427	4117	D4h	D2h	
N160	535	589	160	215	516	5209	D4h	D2h	

## [T2] 3 x 200-240 V AC – high overload

Type code	High overload (150% 1 min/10 min)						Enclosure size		
	Output current (3 x 200-240 V)		Typical shaft output power		Continuous input current	Estimated power loss	Protection rating [IEC/UL]		
	Con. I <sub>N</sub>	Inter. I <sub>MAX</sub> (60 s)	kW	HP @ 230 V	[A]	[W]	IP20	IP21	IP54
FC-202	Con. I <sub>N</sub>	Inter. I <sub>MAX</sub> (60 s)	kW	HP @ 230 V	[A]	[W]	Chassis	Type 1	Type 12
N55K	160	240	45	60	154	1482	D3h	D1h	
N75K	190	285	55	75	183	1794	D3h	D1h	
N90K	240	360	75	100	231	1990	D4h	D2h	
N110	302	453	90	120	291	2613	D4h	D2h	
N150	361	542	110	150	348	3195	D4h	D2h	
N160	443	665	150	200	427	4103	D4h	D2h	



**[T4] 3 x 380-480 V AC – normal overload**

Normal overload (110% 1 min/10 min)									Enclosure size		
Type code	Output current				Typical shaft output power		Con- tinuous input current	Estimat- ed power loss	Protection rating [IEC/UL]		
	(3 x 380-440 V)		(3 x 441-500 V)						IP20	IP21	IP54
FC-202	Con. I <sub>N</sub>	Inter. I <sub>MAX</sub> (60 s)	Con. I <sub>N</sub>	Inter. I <sub>MAX</sub> (60 s)	kW @ 400 V	Hp @ 460 V	[A] @ 400 V	[W]	Chassis	Type 1	Type 12
N110	212	233	190	209	110	150	204	2559	D3h	D1h/D5h/D6h	
N132	260	286	240	264	132	200	251	2954	D3h	D1h/D5h/D6h	
N160	315	347	302	332	160	250	304	3770	D3h	D1h/D5h/D6h	
N200	395	435	361	397	200	300	381	4116	D4h	D2h/D7h/D8h	
N250	480	528	443	487	250	350	463	5137	D4h	D2h/D7h/D8h	
N315	588	647	535	588	315	450	567	6674	D4h	D2h/D7h/D8h	
N355	658	724	590	649	355	500	634	6928	E3h	E1h	E1h
N400	745	820	678	746	400	600	718	8036	E3h	E1h	E1h
N450	800	880	730	803	450	600	771	8783	E3h	E1h	E1h
N500	880	968	780	858	500	650	848	9473	E4h	E2h	E2h
N560	990	1089	890	979	560	750	954	11102	E4h	E2h	E2h
P500	880	968	780	858	500	650	848	10162	–	F1/F3	F1/F3
P560	990	1089	890	979	560	750	954	11822	–	F1/F3	F1/F3
P630	1120	1232	1050	1155	630	900	1079	12512	–	F1/F3	F1/F3
P710	1260	1386	1160	1276	710	1000	1214	14674	–	F1/F3	F1/F3
P800	1460	1606	1380	1518	800	1200	1407	17293	–	F2/F4	F2/F4
P1M0	1720	1892	1530	1683	1000	1350	1658	19278	–	F2/F4	F2/F4

**[T4] 3 x 380-480 V AC – high overload**

High overload (150% 1 min/10 min)									Enclosure size		
Type code	Output current				Typical shaft output power		Con- tinuous input current	Estimat- ed power loss	Protection rating [IEC/UL]		
	(3 x 380-440 V)		(3 x 441-500 V)						IP20	IP21	IP54
FC-202	Con. I <sub>N</sub>	Inter. I <sub>MAX</sub> (60 s)	Con. I <sub>N</sub>	Inter. I <sub>MAX</sub> (60 s)	kW @ 400 V	Hp @ 460 V	[A] @ 400 V	[W]	Chassis	Type 1	Type 12
N110	177	266	160	240	90	125	171	2031	D3h	D1h/D5h/D6h	
N132	212	318	190	285	110	150	204	2289	D3h	D1h/D5h/D6h	
N160	260	390	240	360	132	200	251	2923	D3h	D1h/D5h/D6h	
N200	315	473	302	453	160	250	304	3093	D4h	D2h/D7h/D8h	
N250	395	593	361	542	200	300	381	4039	D4h	D2h/D7h/D8h	
N315	480	720	443	665	250	350	463	5005	D4h	D2h/D7h/D8h	
N355	600	900	540	810	315	450	578	6178	E3h	E1h	E1h
N400	658	987	590	885	355	500	634	6851	E3h	E1h	E1h
N450	695	1043	678	1017	400	550	670	7297	E3h	E1h	E1h
N500	800	1200	730	1095	450	600	771	8352	E4h	E2h	E2h
N560	880	1320	780	1170	500	650	848	9449	E4h	E2h	E2h
P500	800	1200	730	1095	450	600	771	9031	–	F1/F3	F1/F3
P560	880	1320	780	1170	500	650	848	10146	–	F1/F3	F1/F3
P630	990	1485	890	1335	560	750	954	10649	–	F1/F3	F1/F3
P710	1120	1680	1050	1575	630	900	1079	12490	–	F1/F3	F1/F3
P800	1260	1890	1160	1740	710	1000	1214	14244	–	F2/F4	F2/F4
P1M0	1460	2190	1380	2070	800	1200	1407	15466	–	F2/F4	F2/F4

### [T7] 3 x 525-690 V AC – normal overload

Normal overload (110% 1 min/10 min)									Enclosure size		
Type code	Output current				Typical shaft output power		Continuous input current	Estimated power loss	Protection rating [IEC/UL]		
	(3 x 525-550 V)		(3 x 551-690 V)						IP20	IP21	IP54
FC-202	Con. I <sub>N</sub>	Inter. I <sub>MAX</sub> (60 s)	Con. I <sub>N</sub>	Inter. I <sub>MAX</sub> (60 s)	kW @ 690 V	Hp @ 575 V	[A] @ 690 V	[W]	Chassis	Type 1	Type 12
N75K	90	99	86	95	75	75	83	1162	D3h	D1h/D5h/D6h	
N90K	113	124	108	119	90	100	104	1428	D3h	D1h/D5h/D6h	
N110	137	151	131	144	110	125	126	1740	D3h	D1h/D5h/D6h	
N132	162	178	155	171	132	150	149	2101	D3h	D1h/D5h/D6h	
N160	201	221	192	211	160	200	185	2649	D3h	D1h/D5h/D6h	
N200	253	278	242	266	200	250	233	3074	D4h	D2h/D7h/D8h	
N250	303	333	290	319	250	300	279	3723	D4h	D2h/D7h/D8h	
N315	360	396	344	378	315	350	332	4465	D4h	D2h/D7h/D8h	
N400	418	460	400	440	400	400	385	5028	D4h	D2h/D7h/D8h	
N450	470	517	450	495	450	450	434	6062	E3h	E1h	E1h
N500	523	575	500	550	500	500	482	6879	E3h	E1h	E1h
N560	596	656	570	627	560	600	549	8076	E3h	E1h	E1h
N630	630	693	630	693	630	650	607	9208	E3h	E1h	E1h
N710	763	839	730	803	710	750	704	10346	E4h	E2h	E2h
N800	889	978	850	935	800	950	819	12723	E4h	E2h	E2h
P710	763	839	730	803	710	750	704	9212	–	F1/F3	F1/F3
P800	889	978	850	935	800	950	819	10659	–	F1/F3	F1/F3
P900	988	1087	945	1040	900	1050	911	12080	–	F1/F3	F1/F3
P1M0	1108	1219	1060	1166	1000	1150	1022	13305	–	F2/F4	F2/F4
P1M2	1317	1449	1260	1386	1200	1350	1214	15865	–	F2/F4	F2/F4
P1M4	1479	1627	1415	1557	1400	1550	1364	18173	–	F2/F4	F2/F4

### [T7] 3 x 525-690 V AC – high overload

High overload (150% 1 min/10 min)									Enclosure size		
Type code	Output current				Typical shaft output power		Continuous input current	Estimated power loss	Protection rating [IEC/UL]		
	(3 x 525-550 V)		(3 x 551-690 V)						IP20	IP21	IP54
FC-202	Con. I <sub>N</sub>	Inter. I <sub>MAX</sub> (60 s)	Con. I <sub>N</sub>	Inter. I <sub>MAX</sub> (60 s)	kW @ 690 V	Hp @ 575 V	[A] @ 690 V	[W]	Chassis	Type 1	Type 12
N75K	76	122	73	117	55	60	70	1098	D3h	D1h/D5h/D6h	
N90K	90	135	86	129	75	75	83	1162	D3h	D1h/D5h/D6h	
N110	113	170	108	162	90	100	104	1430	D3h	D1h/D5h/D6h	
N132	137	206	131	197	110	125	126	1742	D3h	D1h/D5h/D6h	
N160	162	243	155	233	132	150	149	2080	D3h	D1h/D5h/D6h	
N200	201	302	192	288	160	200	185	2361	D4h	D2h/D7h/D8h	
N250	253	380	242	363	200	250	233	3012	D4h	D2h/D7h/D8h	
N315	303	455	290	435	250	300	279	3642	D4h	D2h/D7h/D8h	
N400	360	540	344	516	315	350	332	4146	D4h	D2h/D7h/D8h	
N450	395	593	380	570	355	400	366	4989	E3h	E1h	E1h
N500	429	644	410	615	400	400	395	5419	E3h	E1h	E1h
N560	523	785	500	750	500	500	482	6833	E3h	E1h	E1h
N630	596	894	570	855	560	600	549	8069	E3h	E1h	E1h
N710	659	989	630	945	630	650	607	8543	E4h	E2h	E2h
N800	763	1145	730	1095	710	750	704	10319	E4h	E2h	E2h
P710	659	989	630	945	630	650	607	7826	–	F1/F3	F1/F3
P800	763	1145	730	1095	710	750	704	8983	–	F1/F3	F1/F3
P900	889	1334	850	1275	800	950	819	10646	–	F1/F3	F1/F3
P1M0	988	1482	945	1418	900	1050	911	11681	–	F2/F4	F2/F4
P1M2	1108	1662	1060	1590	1000	1150	1022	12997	–	F2/F4	F2/F4
P1M4	1317	1976	1260	1890	1200	1350	1214	15763	–	F2/F4	F2/F4



## Dimensions enclosure size D

Enclosure size		VLT® AQUA Drive									
Protection rating [IEC/UL]		IP21 /Type 1 IP54 /Type 12		IP20 /Chassis				IP21 /Type 1 IP54 /Type 12			
[mm]	Height	901.0	1107.0	909.0	1027.0	1122.0	1294.0	1324.0	1663.0	1978.0	2284.0
	Width	325.0	420.0	250.0	250.0	350.0	350.0	325.0	325.0	420.0	420.0
	Depth	378.4	378.4	375.0	375.0	375.0	375.0	381.0	381.0	386.0	406.0
[kg]	Weight	62.0	125.0	62.0	108.0	125.0	179.0	99.0	128.0	185.0	232.0
[in]	Height	35.5	43.6	35.8	39.6	44.2	50.0	52.1	65.5	77.9	89.9
	Width	12.8	12.8	19.8	9.9	14.8	13.8	12.8	12.8	16.5	16.5
	Depth	14.9	14.9	14.8	14.8	14.8	14.8	15.0	15.0	15.2	16.0
[lb]	Weight	136.7	275.6	136.7	238.1	275.6	394.6	218.3	282.2	407.9	511.5

- <sup>(1)</sup> dimensions with regeneration or load share terminals
- <sup>(2)</sup> D5h is used with disconnect and/or brake chopper options
- <sup>(3)</sup> D6h is used with contactor and/or circuit breaker options
- <sup>(4)</sup> D7h is used with disconnect and/or brake chopper options
- <sup>(5)</sup> D8h is used with contactor and/or circuit breaker options

## Dimensions enclosure sizes E and F

Frame		VLT® AQUA Drive							
Protection rating [IEC/UL]		IP21 /Type 1 IP54 /Type 12		IP20 /Chassis		IP21 /Type 1 IP54 /Type 12			
[mm]	Height	2043.0	2043.0	1578.0	1578.0	2204.0	2204.0	2204.0	2204.0
	Width	602.0	698.0	506.0	604.0	1400.0	1800.0	2000.0	2400.0
	Depth	513.0	513.0	482.0	482.0	606.0	606.0	606.0	606.0
[kg]	Weight	295.0	318.0	272.0	295.0	1017.0	1260.0	1318.0	1561.0
[in]	Height	80.4	80.4	62.1	62.1	86.8	86.8	86.8	86.8
	Width	23.7	27.5	199.9	23.9	55.2	70.9	78.8	94.5
	Depth	20.2	20.2	19.0	19.0	23.9	23.9	23.9	23.9
[lb]	Weight	650.0	700.0	600.0	650.0	2242.1	2777.9	2905.7	3441.5

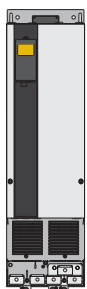

D3h/D4h

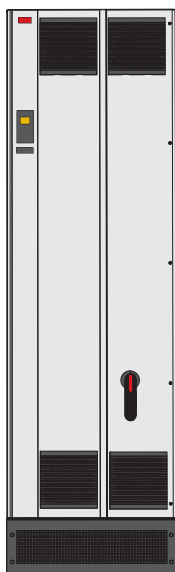

E1h



F



# Electrical data and dimensions

## – VLT® 12-Pulse

### [T4] 6 x 380-480 V AC – normal overload

Type code	Normal overload (110% 1 min/10 min)								Enclosure size			
	Output current				Typical shaft output power		Continuous input current	Estimated power loss	Protection rating [IEC/UL]			
	(3 x 380-440 V)		(3 x 441-480 V)						IP21/Type 1		IP54/Type 12	
FC-202	Con. I <sub>N</sub>	Inter. I <sub>MAX</sub> (60 s)	Con. I <sub>N</sub>	Inter. I <sub>MAX</sub> (60 s)	kW @ 400 V	Hp @ 460 V	[A] @ 400 V	[W]	AC drive	+ options	AC drive	+ options
P315	600	660	540	594	315	450	590	6790	F8	F9	F8	F9
P355	658	724	590	649	355	500	647	7701	F8	F9	F8	F9
P400	745	820	678	746	400	600	733	8879	F8	F9	F8	F9
P450	800	880	730	803	450	600	787	9670	F8	F9	F8	F9
P500	880	968	780	858	500	650	857	10647	F10	F11	F10	F11
P560	990	1089	890	979	560	750	964	12338	F10	F11	F10	F11
P630	1120	1232	1050	1155	630	900	1090	13201	F10	F11	F10	F11
P710	1260	1386	1160	1276	710	1000	1227	15436	F10	F11	F10	F11
P800	1460	1606	1380	1518	800	1200	1422	18084	F12	F13	F12	F13
P1M0	1720	1892	1530	1683	1000	1350	1675	20358	F12	F13	F12	F13

### [T4] 6 x 380-480 V AC – high overload

Type code	High overload (150% 1 min/10 min)								Enclosure size			
	Output current				Typical shaft output power		Continuous input current	Estimated power loss	Protection rating [IEC/UL]			
	(3 x 380-440 V)		(3 x 441-480 V)						IP21/Type 1		IP54/Type 12	
FC-202	Con. I <sub>N</sub>	Inter. I <sub>MAX</sub> (60 s)	Con. I <sub>N</sub>	Inter. I <sub>MAX</sub> (60 s)	kW @ 400 V	Hp @ 460 V	[A] @ 400 V	[W]	AC drive	+ options	AC drive	+ options
P315	480	720	443	665	250	350	472	5164	F8	F9	F8	F9
P355	600	900	540	810	315	450	590	6960	F8	F9	F8	F9
P400	658	987	590	885	355	500	647	7691	F8	F9	F8	F9
P450	695	1043	678	1017	400	550	684	8178	F8	F9	F8	F9
P500	800	1200	730	1095	450	600	779	9492	F10	F11	F10	F11
P560	880	1320	780	1170	500	650	857	10631	F10	F11	F10	F11
P630	990	1485	890	1335	560	750	964	11263	F10	F11	F10	F11
P710	1120	1680	1050	1575	630	900	1090	13172	F10	F11	F10	F11
P800	1260	1890	1160	1740	710	1000	1227	14967	F12	F13	F12	F13
P1M0	1460	2190	1380	2070	800	1200	1422	16392	F12	F13	F12	F13

## [T7] 6 x 525-690 V AC – normal overload

Normal overload (110% 1 min/10 min)									Enclosure size			
Type code	Output current				Typical shaft output power		Con- tinuous input current	Estimated power loss	Protection rating [IEC/UL]			
	(3 x 525-550 V)		(3 x 551-690 V)						IP21/Type 1		IP54/Type 12	
FC-202	Con. I <sub>N</sub>	Inter. I <sub>MAX</sub> (60 s)	Con. I <sub>N</sub>	Inter. I <sub>MAX</sub> (60 s)	kW @ 690 V	Hp @ 575 V	[A] @ 690 V	[W]	AC drive	+ options	AC drive	+ options
P450	470	517	450	495	450	450	434	5529	F8	F9	F8	F9
P500	523	575	500	550	500	500	482	6239	F8	F9	F8	F9
P560	596	656	570	627	560	600	549	7653	F8	F9	F8	F9
P630	630	693	630	693	630	650	607	8495	F8	F9	F8	F9
P710	763	839	730	803	710	750	711	9863	F10	F11	F10	F11
P800	889	978	850	935	800	950	828	11304	F10	F11	F10	F11
P900	988	1087	945	1040	900	1050	920	12798	F10	F11	F10	F11
P1M0	1108	1219	1060	1166	1000	1150	1032	13801	F12	F13	F12	F13
P1M2	1317	1449	1260	1386	1200	1350	1227	16821	F12	F13	F12	F13
P1M4	1479	1627	1415	1557	1400	1550	1378	19247	F12	F13	F12	F13

## [T7] 6 x 525-690 V AC – high overload

High overload (150% 1 min/10 min)									Enclosure size			
Type code	Output current				Typical shaft output power		Con- tinuous input current	Estimated power loss	Protection rating [IEC/UL]			
	(3 x 525-550 V)		(3 x 551-690 V)						IP21/Type 1		IP54/Type 12	
FC-202	Con. I <sub>N</sub>	Inter. I <sub>MAX</sub> (60 s)	Con. I <sub>N</sub>	Inter. I <sub>MAX</sub> (60 s)	kW @ 690 V	Hp @ 575 V	[A] @ 690 V	[W]	AC drive	+ options	AC drive	+ options
P450	395	593	380	570	355	400	366	4589	F8	F9	F8	F9
P500	429	644	410	615	400	400	395	4970	F8	F9	F8	F9
P560	523	785	500	750	500	500	482	6707	F8	F9	F8	F9
P630	596	894	570	855	560	600	549	7633	F8	F9	F8	F9
P710	659	989	630	945	630	650	613	8388	F10	F11	F10	F11
P800	763	1145	730	1095	710	750	711	9537	F10	F11	F10	F11
P900	889	1334	850	1275	800	950	828	11291	F10	F11	F10	F11
P1M0	988	1482	945	1418	900	1050	920	12524	F12	F13	F12	F13
P1M2	1108	1662	1060	1590	1000	1150	1032	13801	F12	F13	F12	F13
P1M4	1317	1976	1260	1890	1200	1350	1227	16719	F12	F13	F12	F13

## Dimensions enclosure size F

Enclosure size		VLT® AQUA Drive					
		F8	F9	F10	F11	F12	F13
Protection rating [IEC/UL]		IP21/Type 1 IP54/Type 12					
[mm]	Height	2204.0	2204.0	2204.0	2204.0	2204.0	2204.0
	Width	800.0	1400.0	1600.0	2400.0	2000.0	2800.0
	Depth	606.0	606.0	606.0	606.0	606.0	606.0
[kg]	Weight	447.0	669.0	893.0	1116.0	1037.0	1259.0
[in]	Height	86.8	86.8	86.8	86.8	86.8	86.8
	Width	31.5	55.2	63.0	94.5	78.8	110.2
	Depth	23.9	23.9	23.9	23.9	23.9	23.9
[lb]	Weight	985.5	1474.9	1968.8	2460.4	2286.4	2775.7





# Electrical data and dimensions

## – Enclosed Drive

### [T5] 3 x 380-500 V AC – high overload

High overload (150% 1 min/10 min)										
Type code	Output current				Typical shaft output power		Continuous input current	Estimated power loss	Protection rating	
	(3 x 380-440 V)		(3 x 441-480 V)		kW @ 400 V	Hp @ 460 V			IP21	IP54
FC-202	Con. I <sub>N</sub>	Inter. I <sub>MAX</sub> (60 s)	Con. I <sub>N</sub>	Inter. I <sub>MAX</sub> (60 s)					[A] @ 400 V	[W]
N110	177	266	160	240	90	125	171	2031	D9h	D9h
N132	212	318	190	285	110	150	204	2289	D9h	D9h
N160	260	390	240	360	132	200	251	2923	D9h	D9h
N200	315	473	302	453	160	250	304	3093	D10h	D10h
N250	395	593	361	542	200	300	381	4039	D10h	D10h
N315	480	720	443	665	250	350	463	5005	D10h	D10h
N355	600	900	540	810	315	450	578	6178	E5h	E5h
N400	658	987	590	885	355	500	634	6851	E5h	E5h
N450	695	1043	678	1017	400	550	718	7297	E5h	E5h
N500	800	1200	730	1095	450	600	771	8352	E6h	E6h
N560	880	1320	780	1170	500	650	848	9449	E6h	E6h

### [T5] 3 x 380-500 V AC – normal overload

Normal overload (110% 1 min/10 min)										
Type code	Output current				Typical shaft output power		Continuous input current	Estimated power loss	Protection rating	
	(3 x 380-440 V)		(3 x 441-480 V)		kW @ 400 V	Hp @ 460 V			IP21	IP54
FC-202	Con. I <sub>N</sub>	Inter. I <sub>MAX</sub> (60 s)	Con. I <sub>N</sub>	Inter. I <sub>MAX</sub> (60 s)					[A] @ 400V	[W]
N110	212	233	190	209	110	150	204	2559	D9h	D9h
N132	260	286	240	264	132	200	251	2954	D9h	D9h
N160	315	347	302	332	160	250	304	3770	D9h	D9h
N200	395	435	361	397	200	300	381	4116	D10h	D10h
N250	480	528	443	487	250	350	463	5137	D10h	D10h
N315	588	647	535	588	315	450	578	6674	D10h	D10h
N355	658	724	590	649	355	500	634	6928	E5h	E5h
N400	745	820	678	746	400	600	718	8036	E5h	E5h
N450	800	880	730	803	450	600	771	8783	E5h	E5h
N500	880	968	780	858	500	650	848	9473	E6h	E6h
N560	990	1089	890	979	560	750	954	11102	E6h	E6h



### [T7] 3 x 525-690 V AC – high overload

High overload (150% 1 min/10 min)									Protection rating	
Type code	Output current				Typical shaft output power		Continuous input current	Estimated power loss	IP21	IP54
	(3 x 525-550 V)		(3 x 551-690 V)		kW @ 690 V	Hp @ 575 V			Type 1	Type 12
FC-202	Con. I <sub>N</sub>	Inter. I <sub>MAX</sub> (60 s)	Con. I <sub>N</sub>	Inter. I <sub>MAX</sub> (60 s)					[A] @ 690 V	[W]
N110	113	170	108	162	90	100	109	1479	D9h	D9h
N132	137	206	131	197	110	125	132	1798	D9h	D9h
N160	162	243	155	233	132	150	156	2157	D9h	D9h
N200	201	302	192	288	160	200	193	2443	D10h	D10h
N250	253	380	242	363	200	250	244	3121	D10h	D10h
N315	303	455	290	435	250	300	292	3768	D10h	D10h
N355	360	540	344	516	315	350	347	4254	D10h	D10h
N400	395	593	380	570	355	400	381	4989	E5h	E5h
N500	429	644	410	615	400	400	413	5419	E5h	E5h
N560	523	785	500	750	500	500	504	6833	E5h	E5h
N630	596	894	570	855	560	600	574	8069	E5h	E5h
N710	659	989	630	945	630	650	635	8543	E6h	E6h
N800	763	1145	730	1095	710	750	735	10319	E6h	E6h

### [T7] 3 x 525-690 V AC – normal overload

Normal overload (110% 1 min/10 min)									Protection rating	
Type code	Output current				Typical shaft output power		Continuous input current	Estimated power loss	IP21	IP54
	(3 x 525-550 V)		(3 x 551-690 V)		kW @ 690 V	Hp @ 575 V			Type 1	Type 12
FC-202	Con. I <sub>N</sub>	Inter. I <sub>MAX</sub> (60 s)	Con. I <sub>N</sub>	Inter. I <sub>MAX</sub> (60 s)					[A] @ 690 V	[W]
N110	137	151	131	144	110	125	132	1796	D9h	D9h
N132	162	178	155	171	132	150	156	2165	D9h	D9h
N160	201	221	192	211	160	200	193	2738	D9h	D9h
N200	253	278	242	266	200	250	244	3172	D10h	D10h
N250	303	333	290	319	250	300	292	3848	D10h	D10h
N315	360	396	344	378	315	350	347	4610	D10h	D10h
N355	418	460	400	440	400	400	381	5150	D10h	D10h
N400	470	517	450	495	450	450	413	6062	E5h	E5h
N500	523	575	500	550	500	500	504	6879	E5h	E5h
N560	596	656	570	627	560	600	574	8076	E5h	E5h
N630	630	693	630	693	630	650	635	9208	E5h	E5h
N710	763	839	730	803	710	750	735	10346	E6h	E6h
N800	889	978	850	935	800	950	857	12723	E6h	E6h





# Dimensions for Enclosed Drive

VLT® AQUA Drive				
	D9h	D10h	E5h	E6h
<b>Enclosed Drive</b>				
Rated power at 380–500 V [kW (hp)]	90–132 (125–200)	160–250 (250–350)	315–400 (450–550)	450–500 (600–650)
Rated power at 525–690 V [kW (hp)]	90–132 (100–150)	160–315 (200–350)	355–560 (400–600)	630–710 (650–950)
Protection rating	IP21/Type 1 IP54/Type 12	IP21/Type 1 IP54/Type 12	IP21/Type 1 IP54/Type 12	IP21/Type 1 IP54/Type 12
<b>Drive cabinet</b>				
Height [mm (in)] <sup>1)</sup>	2100 (82.7)	2100 (82.7)	2100 (82.7)	2100 (82.7)
Width [mm (in)] <sup>2)</sup>	400 (15.8)	600 (23.6)	600 (23.6)	800 (31.5)
Depth [mm (in)]	600 (23.6)	600 (23.6)	600 (23.6)	600 (23.6)
Weight [kg (lb)] <sup>2)</sup>	280 (617)	355 (783)	400 (882)	431 (950)
<b>Input filter cabinet</b>				
Height [mm (in)] <sup>1)</sup>	–	2100 (82.7)	2100 (82.7)	2100 (82.7)
Width [mm (in)]	–	600 (23.6)	600 (23.6)	600 (23.6)
Depth [mm (in)]	–	600 (23.6)	600 (23.6)	600 (23.6)
Weight [kg (lb)]	–	380 (838)	380 (838)	380 (838)
<b>Sine-wave filter cabinet</b>				
Height [mm (in)] <sup>1)</sup>	2100 (82.7)	2100 (82.7)	2100 (82.7)	2100 (82.7)
Width [mm (in)]	600 (23.6)	600 (23.6)	1200 (47.2)	1200 (47.2)
Depth [mm (in)]	600 (23.6)	600 (23.6)	600 (23.6)	600 (23.6)
Weight [kg (lb)]				
<b>dV/dt filter cabinet</b>				
Height [mm (in)] <sup>1)</sup>	–	–	2100 (82.7)	2100 (82.7)
Width [mm (in)] <sup>3)</sup>	–	–	400 (15.8)	400 (15.8)
Depth [mm (in)]	–	–	600 (23.6)	600 (23.6)
Weight [kg (lb)]	–	–	240 (529)	240 (529)
<b>Top entry/exit cabinet</b>				
Height [mm (in)] <sup>1)</sup>	2100 (82.7)	2100 (82.7)	2100 (82.7)	2100 (82.7)
Width [mm (in)] <sup>3)</sup>	400 (15.8)	400 (15.8)	400 (15.8)	400 (15.8)
Depth [mm (in)]	600 (23.6)	600 (23.6)	600 (23.6)	600 (23.6)
Weight [kg (lb)]	164 (362)	164 (362)	164 (362)	164 (362)

<sup>1)</sup> Cabinet height includes standard 100 mm (3.9 in) plinth. A 200 mm (7.9 in) or 400 mm (15.8 in) plinth is optional.

<sup>2)</sup> Without options.

<sup>3)</sup> The E5h and E6h enclosures contain 2 sine wave cabinets. The provided width is the total of both cabinets.





PLV-

AE	AC socket+cabinet light + extended I/O terminals + cabinet heater
AF	AC socket+cabinet light + extended I/O terminals + motor heater control
AG	AC socket+cabinet light + extended I/O terminals + insulation monitor
AH	AC socket+cabinet light + extended I/O terminals + cabinet heater + motor heater control
AI	AC socket+cabinet light + extended I/O terminals + cabinet heater + insulation monitor
AJ	AC socket+cabinet light + extended I/O terminals + motor heater control + insulation monitor
AK	AC socket+cabinet light + extended I/O terminals + cabinet heater + motor heater control + insulation monitor
AL	AC socket+cabinet light + cabinet heater + motor heater control
AM	AC socket+cabinet light + cabinet heater + insulation monitor
AN	AC socket+cabinet light + cabinet heater + motor heater control + insulation monitor
AO	AC socket+cabinet light + motor heater control + insulation monitor
AP	Extended I/O terminals + cabinet heater
AQ	Extended I/O terminals + motor heater control
AR	Extended I/O terminals + insulation monitor
AS	Extended I/O terminals + cabinet heater + motor heater control
AT	Extended I/O terminals + cabinet heater + insulation monitor
AU	Extended I/O terminals + cabinet heater + motor heater control + insulation monitor
AV	Extended I/O terminals + motor heater control + insulation monitor
AW	Cabinet heater + motor heater control
A8	Cabinet heater + insulation monitor
AY	Cabinet heater + motor heater control + insulation monitor
AZ	Motor heater control + insulation monitor
<b>[16] LCP display (character 25)</b>	
L	LCP at door
N	No LCP
<b>[17] Enclosure rating (character 26-27)</b>	
21	IP21
54	IP54

<b>[18] Door-mounted option (character 28-29)</b>	
XX	None
D1	Signal lights and reset button
D2	Emergency switch off and emergency press button
D3	STO with emergency press button (no functional safety)
D4	STO/SS1 with emergency press button + SLS (TTL Enc)
D5	STO/SS1 with emergency press button + SLS (HTL Enc)
DA	Signal lights and reset button + emergency switch off and emergency press button
DB	Signal lights and reset button + STO with emergency press button (no functional safety)
DC	Signal lights and reset button + STO/SS1 with emergency press button +SLS (TTL Enc)
DE	Signal lights and reset button + STO/SS1 with emergency press button +SLS (HTL Enc)
<b>[19] A-options: Fieldbus (character 30)</b>	
X	No option
0	VLT® PROFIBUS DP MCA 101
4	VLT® DeviceNet MCA 104
L	VLT® PROFINET MCA 120
N	VLT® EtherNet/IP MCA 121
Q	VLT® Modbus TCP MCA 122
K	VLT® BACnet/IP MCA 125
<b>[20] B-options (character 31)</b>	
X	No application option
K	VLT® General Purpose MCB 101
P	VLT® Relay Option MCB 105
2	VLT® PTC Thermistor Card MCB 112
4	VLT® Sensor Input Card MCB 114
Y	VLT® Extended Cascade Controller MCO 101
<b>[21] C0-option (character 32)</b>	
X	No option
<b>[22] C1-option (character 33)</b>	
X	No option
5	VLT® Advanced Cascade Controller MCO 102
R	VLT® Extended Relay Card MCB 113
<b>[23] C-option software (character 34)</b>	
X	No software option

<b>[24] D-option (character 35)</b>	
X	No option
0	VLT® 24 V DC Supply Option MCB 107
1	VLT® Real-time Clock Option MCB 117
<b>[25] EMC filter (character 36)</b>	
2	(H2) RFI class A2 (C3)
4	(H4) RFI class A1 (C2)
6	IT Grid
<b>[26] Reserved (character 37)</b>	
X	None
<b>[27] Reserved (character 38-39)</b>	
XX	None
<b>[28] Documentation language (character 40)</b>	
X	English only
G	English + German
F	English + French

Please beware that not all combinations are possible. Find help configuring your drive with the online configurator found under: [driveconfig.danfoss.com](http://driveconfig.danfoss.com)



# Electrical data – VLT® Low Harmonic Drive and VLT® Advanced Active Filters

## [T4] 3 x 380-480 V AC – VLT® Low Harmonic Drive

High overload (150% 1 min/10 min)									Enclosure size	
Type code	Output current				Typical shaft output power		Continu-ous input current	Estimat-ed power loss	Protection rating [IEC/UL]	
	(3 x 380-440 V)		(3 x 441-480 V)						IP21	IP55
FC-202	Con. I <sub>N</sub>	Inter. I <sub>MAX</sub> (60 s)	Con. I <sub>N</sub>	Inter. I <sub>MAX</sub> (60 s)	kW @ 400 V	Hp @ 460 V	[A]	[W]	Type 1	Type 12
N160	260	390	240	360	132	200	251	7428	D1n	D1n
N200	315	473	302	453	160	250	304	8048	D2n	D2n
N250	395	593	361	542	200	300	381	9753	D2n	D2n
P315	480	720	443	665	250	350	472	11587	E9	E9
P355	600	900	540	810	315	450	590	14140	E9	E9
P400	658	987	590	885	355	500	647	15286	E9	E9
P450	695	1043	678	1017	400	550	684	16063	E9	E9
P500	800	1200	730	1095	450	600	779	20077	F18	F18
P560	880	1320	780	1170	500	650	857	21851	F18	F18
P630	900	1485	890	1335	560	750	964	23320	F18	F18
P710	1120	1680	1050	1575	630	900	1090	26559	F18	F18

## [T4] 3 x 380-480 V AC – VLT® Low Harmonic Drive

Normal overload (110% 1 min/10 min)									Enclosure size	
Type code	Output current				Typical shaft output power		Continu-ous input current	Estimat-ed power loss	Protection rating [IEC/UL]	
	(3 x 380-440 V)		(3 x 441-480 V)						IP21	IP55
FC-202	Con. I <sub>N</sub>	Inter. I <sub>MAX</sub> (60 s)	Con. I <sub>N</sub>	Inter. I <sub>MAX</sub> (60 s)	kW @ 400 V	Hp @ 460 V	[A]	[W]	Type 1	Type 12
N160	315	347	302	332	160	250	304	8725	D1n	D1n
N200	395	435	361	397	200	300	381	9831	D2n	D2n
N250	480	528	443	487	250	350	463	11371	D2n	D2n
P315	600	660	540	594	315	450	590	14051	E9	E9
P355	658	724	590	649	355	500	647	15320	E9	E9
P400	745	820	678	746	400	600	733	17180	E9	E9
P450	800	880	730	803	450	600	787	18447	E9	E9
P500	800	968	780	858	500	650	857	21909	F18	F18
P560	990	1089	890	979	560	750	964	24592	F18	F18
P630	1120	1232	1050	1155	630	900	1090	26640	F18	F18
P710	1260	1380	1160	1276	710	1000	1227	30519	F18	F18

## [T4] 3 x 380-480 V AC VLT® Advanced Active Filter

Normal overload (110% 1 min/10 min automatically regulated)										Enclosure size		
Type code	Output current								Recom-mended fuse and disconnect rating*	Estimat-ed power loss	Protection rating [IEC/UL]	
	@ 400 V		@ 460 V		@ 480 V		@ 500 V				IP21	IP54
AAF006	Reac-tive	Harmo-nics	Reac-tive	Harmo-nics	Reac-tive	Harmo-nics	Reac-tive	Harmo-nics	[A]	[W]	Type 1	Type 12
A190	190	171	190	171	190	171	190	152	350	5000	D14	D14
A250	250	225	250	225	250	225	250	200	630	7000	E1	E1
A310	310	279	310	279	310	279	310	248	630	9000	E1	E1
A400	400	360	400	360	400	360	400	320	900	11100	E1	E1

\* Built-in options for fuses and disconnect recommended

# Dimensions – VLT® Low Harmonic Drive and VLT® Advanced Active Filter

Enclosure size		VLT® Low Harmonic Drive				VLT® Advanced Active Filter	
		D1n	D2n	E9	F18	D14	E1
Protection rating [IEC/UL]		IP21 /Type 1 IP54 /Type 12				IP21 /Type 1 IP54 /Type 12	
[mm]	Height	1781.70	1781.7	2000.7	2278.4	1780.0	2000.0
	Width	929.2	1024.2	1200.0	2792.0	600.0	600.0
	Depth	418.4	418.4	538.0	605.8	418.4	538.0
[kg]	Weight	353.0	413.0	676.0	1900.0	238.0	453.0
[in]	Height	70.1	70.1	78.8	89.7	70.0	78.7
	Width	36.6	40.3	47.2	109.9	23.6	23.6
	Depth	16.5	16.5	21.0	23.9	16.5	21.0
[lb]	Weight	777.0	910.0	1490.0	4189.0	524.7	998.7

## Specifications VLT® Advanced Active Filter

<b>Filter type</b>	3P/3W, Active Shunt Filter (TN, TT, IT)	<b>Harmonics currents capability in % from the rated current</b>	I5: 63%, I7: 45%, I11: 29%, I13: 25%, I17: 18%, I19: 16%, I23: 14%, I25: 13%
<b>Frequency</b>	50 to 60 Hz, ± 5%	<b>Reactive current compensation</b>	Yes, leading (capacitive) or lagging (inductive) to target power factor
<b>Enclosures</b>	IP21 – NEMA 1, IP54 – NEMA 12	<b>Flicker reduction</b>	Yes
<b>Max. voltage pre-distortion</b>	10% 20% with reduced performance	<b>Compensation priority</b>	Programmable to harmonics or displacement power factor
<b>Operating temperature</b>	0-40 °C +5 °C with reduced performance -10 °C with reduced performance	<b>Paralleling option</b>	Up to 4 units of same power rating in master-follower setup
<b>Altitude</b>	1000 m without derating 3000 m with reduced performance (5%/1000 m)	<b>Current Transformer Support (Customer supply and field mounting)</b>	1 A or 5 A secondary with auto tuning Class 0.5 or better
<b>EMC standards</b>	IEC61000-6-2 IEC61000-6-4	<b>Digital inputs /outputs</b>	4 (2 programmable) Programmable PNP or NPN logic
<b>Circuitry coating</b>	Conformal coated – per ISA S71.04-1985, class G3	<b>Communication interface</b>	RS485, USB1.1
<b>Languages</b>	18 different	<b>Control type</b>	Direct harmonic control (for faster response)
<b>Harmonic compensation modes</b>	Selective or overall (90% RMS for harmonic reduction)	<b>Response time</b>	< 15 ms (including HW)
<b>Harmonic compensation spectrum</b>	2 <sup>nd</sup> to 40 <sup>th</sup> in overall mode, including triplens 5 <sup>th</sup> , 7 <sup>th</sup> , 11 <sup>th</sup> , 13 <sup>th</sup> , 17 <sup>th</sup> , 19 <sup>th</sup> , 23 <sup>rd</sup> , 25 <sup>th</sup> in selective mode	<b>Harmonic settling time (5-95%)</b>	< 15 ms
		<b>Reactive settling time (5-95%)</b>	< 15 ms
		<b>Maximum overshoot</b>	5%
		<b>Switching frequency</b>	Progressive control in the range of 3-18 kHz
		<b>Average switching frequency</b>	3-4.5 kHz

## Typecode VLT® Advanced Active Filter

The different VLT® Active Filters can easily be configured according to customer request at [drives.danfoss.com](http://drives.danfoss.com)

1	2	3	4	5	6	7	8	9	10	11	12	13	14	15	16	17	18	19	20	21	22	23	24	..	39
A	A	F	0	0	6	A	x	x	x	T	4	E	x	x	H	x	x	G	C	x	x	x	S	.	X
<b>8-10:</b> 190: 190 A correction current 250: 250 A correction current 310: 310 A correction current 400: 400 A correction current			<b>13-15:</b> E21: IP 21/NEMA 1 E2M: IP 21/NEMA 1 w. mains shield C2M: IP 21/NEMA 1 w. stainless steel back-channel and mains shield						<b>E54:</b> IP 54/NEMA 12 <b>E5M:</b> IP 54/NEMA 12 w. mains shield <b>C5M:</b> IP 54/NEMA 12 w. stainless steel back-channel and mains shield						<b>16-17:</b> HX: No RFI Filter H4: RFI class A1			<b>21:</b> X: No mains options 3: Disconnect & Fuse 7: Fuse							

# A options: Fieldbuses

Available for the full product range

Fieldbus	Typecode position
<b>A</b>	
VLT® PROFIBUS DP MCA 101	14
VLT® DeviceNet MCA 104	
VLT® PROFINET MCA 120	
VLT® EtherNet/IP MCA 121	
VLT® Modbus TCP MCA 122	
VLT® BACnet/IP MCA 125	

## PROFIBUS DP

Operating the AC drive via a fieldbus enables you to reduce the cost of your system, communicate faster and more efficiently and benefit from an easier user interface.

Other features:

- Wide compatibility, a high level of availability, support for all major PLC vendors, and compatibility with future versions
- Fast, efficient communication, transparent installation, advanced diagnosis and parameterization and auto-configuration of process data via GSD-file
- Acyclic parameterization using PROFIBUS DP-V1, PROFIdrive or Danfoss FC (MCA 101 only) profile state machines, PROFIBUS DP-V1, Master Class 1 and 2

### VLT® PROFIBUS DP MCA 101

#### Order code

130B1100 standard  
130B1200 coated

## DeviceNet

DeviceNet offers robust, efficient data handling thanks to advanced Producer/Consumer technology.

- Support of ODVA's AC drive profile supported via I/O instance 20/70 and 21/71 secures compatibility to existing systems
- Benefit from ODVA's strong conformance testing policies, which ensure that products are interoperable
- Built-in web server
- E-mail client for service notification

### VLT® DeviceNet MCA 104

#### Order code

130B1102 standard  
130B1202 coated

## PROFINET

PROFINET uniquely combines the highest performance with the highest degree of openness. The option is designed so that many of the features from the PROFIBUS can be reused, minimizing user effort to migrate PROFINET and securing the investment in a PLC program.

- Same PPO types as PROFIBUS for easy migration to PROFINET
- Support of MRP
- Support of DP-V1 Diagnostic allows easy, fast and standardized handling of warning and fault information into the PLC, improving bandwidth in the system
- Implementation in accordance with Conformance Class B
- Built-in web server
- E-mail client for service notification

### VLT® PROFINET MCA 120

#### Order code

130B1135 standard, dual-port  
130B1235 coated, dual-port

## EtherNet/IP

Ethernet is the future standard for communication at the factory floor. EtherNet/IP is based on the newest technology available for industrial use and handles even the most demanding requirements.

EtherNet/IP™ extends commercial off-the-shelf Ethernet to the Common Industrial Protocol (CIP™) – the same upper-layer protocol and object model found in DeviceNet.

The option offers advanced features such as:

- Built-in high performance switch enabling line-topology, and eliminating the need for external switches
- DLR Ring
- Advanced switch and diagnosis functions
- Built-in web server
- E-mail client for service notification
- Unicast and Multicast communication

### VLT® EtherNet/IP MCA 121

#### Order code

130B1119 standard, dual-port  
130B1219 coated, dual-port

## Modbus TCP

Modbus TCP is the first industrial Ethernet-based protocol for automation. Modbus TCP is able to handle connection intervals down to 5 ms in both directions, positioning it among the fastest performing Modbus TCP devices in the market. For master redundancy, it features hot swapping between two masters.

Other features:

- Dual Master PLC connection for redundancy in dual port options (MCA 122 only)

### VLT® Modbus TCP MCA 122

#### Order code

130B1196 standard, dual-port  
130B1296 coated, dual-port

## BACnet/IP

The BACnet/IP option optimizes the use of VLT® AQUA Drive together with building management systems (BMS) using the BACnet/IP protocol or running BACnet on Ethernet. BACnet/IP makes it easy to control or to monitor points required in typical HVAC applications, reducing overall cost of ownership.

Other features:

- COV, Change Of Value
- Read/WritePropertyMultiple
- Alarm/Warning notifications
- PID Loop object
- Segmented data transfer
- Trend Objects
- Schedule Objects

### VLT® BACnet/IP MCA 125

#### Order code

134B1586 coated, dual-port

# B options: Functional extensions

Available for the full product range

Functional extensions	Typecode position
<b>B</b>	
VLT® General Purpose MCB 101	<b>15</b>
VLT® Relay Option MCB 105	
VLT® Analog I/O Option MCB 109	
VLT® PTC Thermistor Card MCB 112	
VLT® Sensor Input Card MCB 114	
VLT® Extended Cascade Controller MCO 101	

## VLT® General Purpose I/O MCB 101

This I/O option offers an extended number of control inputs and outputs:

- 3 digital inputs 0-24 V: Logic '0' < 5 V; Logic '1' > 10V
- 2 analog inputs 0-10 V: Resolution 10 bit plus sign
- 2 digital outputs NPN/PNP push pull
- 1 analog output 0/4-20 mA
- Spring-loaded connection

### Ordering number

130B1125 standard  
130B1212 coated (Class 3C3/IEC 60721-3-3)

## VLT® Relay Card MCB 105

Makes it possible to extend relay functions with 3 additional relay outputs.

- Max. switch rate at rated load/min. load .....6 min<sup>-1</sup>/20 sec<sup>-1</sup>
- Protects control cable connection
- Spring-loaded control wire connection

### Max. terminal load:

- AC-1 Resistive load .....240 V AC 2 A
- AC-15 Inductive load @cos phi 0.4 .....240 V AC 0.2 A
- DC-1 Resistive load .....24 V DC 1 A
- DC-13 Inductive load @cos phi 0.4 .....24 V DC 0.1 A

### Min. terminal load:

- DC 5 V .....10 mA

### Ordering number

130B1110 standard  
130B1210 coated (Class 3C3/IEC 60721-3-3)

## VLT® Analog I/O Option MCB 109

This analog input/output option is easily fitted in the AC drive for upgrading to advanced performance and control using the additional I/O. This option also upgrades the AC drive with a battery back-up supply for the AC drive built-in clock. This provides stable use of all AC drive clock functions as timed actions.

- 3 analog inputs, each configurable as both voltage and temperature input
- Connection of 0-10 V analog signals as well as Pt1000 and Ni1000 temperature inputs
- 3 analog outputs each configurable as 0-10 V outputs
- Back-up supply for the standard clock function in the AC drive

The back-up battery typically lasts for 10 years, depending on environment.

### Ordering number

130B1143 standard  
130B1243 coated (Class 3C3/IEC 60721-3-3)

## VLT® PTC Thermistor Card MCB 112

The VLT® PTC Thermistor Card MCB 112 enables improved surveillance of the motor condition compared to the built-in ETR function and thermistor terminal.

- Protects the motor from overheating
- ATEX-approved for use with Ex d and Ex e motors
- Uses Safe Torque Off function, which is approved in accordance with SIL 2 IEC 61508

### Ordering number

130B1137 coated (Class 3C3/IEC 60721-3-3)

## VLT® Sensor Input Card MCB 114

This option protects the motor from being overheated by monitoring the temperature of bearings and windings in the motor.

- Protects the motor from overheating
- 3 self-detecting sensor inputs for 2 or 3 wire PT100/PT1000 sensors
- 1 additional analog input 4-20 mA

### Ordering number

130B1172 standard  
130B1272 coated (Class 3C3/IEC 60721-3-3)

## VLT® Extended Cascade Controller MCO 101

Easily fitted and upgrades the built-in cascade controller to operate more pumps and more advanced pump control in master/follower mode.

- Up to 6 pumps in standard cascade setup
- Up to 5 pumps in master/follower setup
- Technical specifications: See VLT® Relay Option MCB 105

### Ordering number

130B1118 standard  
130B1218 coated (Class 3C3/IEC 60721-3-3)

# C options: Cascade controller and relay card

Available for the full product range

Motion control and relay card	Typecode position
<b>C</b>	
VLT® Advanced Cascade Controller MCO 102	16
VLT® Extended Relay Card MCB 113	17

## VLT® Advanced Cascade Controller MCO 102

Easy to fit, the VLT® Advanced Cascade Controller MCO 102 upgrades the built-in cascade controller to operate up to 8 pumps and more advanced pump control in master/follower mode.

MCO 102 supports the combination of multiple variable speed and fixed speed pumps, as well as configurations with pumps of differing capacity (mixed pump control). The additional 7 digital inputs and the 24 V DC connection to the drive enable flexible adaptation to the application. The same cascade-controller hardware is compatible with for the entire power range up to 2 MW.

- Up to 8 pumps in standard cascade set-up
- Up to 8 pumps in master/follower set-up

### Ordering number

130B1154 standard  
130B1254 coated (Class 3C3/IEC 60721-3-3)

## VLT® Extended Relay Card MCB 113

The VLT® Extended Relay Card MCB 113 adds inputs/outputs for increased flexibility.

- 7 digital inputs
- 2 analog outputs
- 4 SPDT relays
- Meets NAMUR recommendations
- Galvanic isolation capability

### Ordering number

130B1164 standard  
130B1264 coated (Class 3C3/IEC 60721-3-3)

# D option: 24 V back-up power supply

Available for the full product range

24 V back-up power supply	Typecode position
<b>D</b>	
VLT® 24 V DC Supply Option MCB 107	19
VLT® Real-time Clock MCB 117	

## VLT® 24 V DC Supply MCB 107

Connect an external DC supply to keep the control section and any installed option functioning during power failure.

This enables full operation of the LCP (including the parameter setting) and all installed options without connection to mains.

- Input voltage range ..... 24 V DC +/- 15% (max. 37 V for 10 sec.)
- Max. input current ..... 2.2 A
- Max. cable length ..... 75 m
- Input capacitance load ..... < 10 uF
- Power-up delay ..... < 0.6 s

### Ordering number

130B1108 standard  
130B1208 coated (Class 3C3/IEC 60721-3-3)

## VLT® Real-time Clock MCB 117

The option provides advanced data-logging functionality. It allows events to be time and date stamped, providing vast amounts of actionable data. The option keeps the drive updated with daily date and real-time data.

- Availability of real time data with reference to run-time data
- Programmable both locally and remotely via option
- Advanced data logging using real-time stamps

### Ordering number

134B6544 coated (Class 3C3/IEC 60721-3-3)





# Power options

## Power option

VLT® Sine-Wave Filter MCC 101

VLT® dU/dt Filter MCC 102

VLT® Common Mode Filters MCC 105

VLT® Advanced Harmonic Filter AHF 005/010

VLT® Brake Resistors MCE 101

VLT® Line Reactor MCC 103

## VLT® Sine-wave Filter MCC 101

- VLT® Sine-wave Filters are positioned between the AC drive and the motor to provide a sinusoidal phase-to-phase motor voltage
- Reduces motor insulation stress
- Reduces acoustic noise from the motor
- Reduces bearing currents (especially in large motors)
- Reduces losses in the motor
- Prolongs service lifetime
- VLT® FC series family look

### Power range

3 x 200-500 V, 2.5-800 A  
3 x 525-690 V, 4.5-660 A

### Enclosure ratings

- IP00 and IP20 wall-mounted enclosures rated up to 75 A (500 V) or 45 A (690 V)
- IP23 floor-mounted enclosures rated 115 A (500 V) or 76 A (690 V) or more
- IP54 both wall-mounted and floor-mounted enclosures rated up to 4.5 A, 10 A, 22 A (690 V)

### Ordering number

See relevant Design Guide

## VLT® dU/dt Filter MCC 102

- Reduces the dU/dt values on the motor terminal phase-to-phase voltage
- Positioned between the AC drive and the motor to eliminate very fast voltage changes
- The motor terminal phase-to-phase voltage is still pulse shaped but its dU/dt values are reduced
- Reduces stress on the motor's insulation and are recommended in applications with older motors, aggressive environments or frequent braking which cause increased DC link voltage
- VLT® FC series family look

### Power range

3 x 200-690 V (up to 880 A)

### Enclosure ratings

- IP00 and IP20/IP23 enclosure in the entire power range
- IP54 enclosure available up to 177 A

### Ordering number

See relevant Design Guide

## VLT® Common Mode Filter MCC 105

- Positioned between the AC drive and the motor
- They are nano-crystalline cores that mitigate high-frequency noise in the motor cable (shielded or unshielded) and reduce bearing currents in the motor
- Extends motor bearing lifetime
- Can be combined with dU/dt and sine-wave filters
- Reduces radiated emissions from the motor cable
- Reduces electromagnetic interference
- Easy to install – no adjustments necessary
- Oval shaped – allows mounting inside the AC drive enclosure or motor terminal box

### Power range

380-415 V AC (50 and 60 Hz)  
440-480 V AC (60 Hz)  
600 V AC (60 Hz)  
500-690 V AC (50 Hz)

### Ordering number

130B3257 Enclosure size A and B  
130B7679 Enclosure size C1  
130B3258 Enclosure size C2, C3 and C4  
130B3259 Enclosure size D  
130B3260 Enclosure size E and F

## VLT® Advanced Harmonic Filter AHF 005 and AHF 010

- Optimized harmonic performance for VLT® drives rated up to 250 kW
- A patented technique reduces THD levels in the mains network to less than 5-10%
- Perfect match for industrial automation, highly dynamic applications and safety installations
- Intelligent cooling with variable-speed fan

### Power range

380-415 V AC (50 and 60 Hz)  
440-480 V AC (60 Hz)  
600 V AC (60 Hz)  
500-690 V AC (50 Hz)

### Enclosure ratings

- IP20  
(An IP21/NEMA 1 upgrade kit is available)

### Ordering number

See relevant Design Guide

## VLT® Brake Resistor MCE 101

- Energy generated during braking is absorbed by the resistors, protecting electrical components from heating up
- Optimized for the FC-series and general versions for horizontal and vertical motion are available
- Built-in thermo switch
- Versions for vertical and horizontal mounting
- A selection of the vertically mounted units are UL-recognized

### Power range

Precision electrical match to each individual VLT® drive power size

### Enclosure ratings:

- IP20
- IP21
- IP54
- IP65

### Ordering number

See relevant Design Guide

## VLT® Line Reactor MCC 103

- Ensures current balance in load-sharing applications, where the DC-side of the rectifier of multiple drives is connected together
- UL-recognized for applications using load sharing
- When planning load-sharing applications, pay special attention to different enclosure type combinations and inrush concepts
- For technical advice regarding load-sharing applications, contact Danfoss application support
- Compatible with VLT® AutomationDrive 50 Hz or 60 Hz mains supply

### Ordering number

See relevant Design Guide

# Accessories

Available for the full product range

## LCP

VLT® Control Panel LCP 101 (Numeric)

**Ordering number:** 130B1124

VLT® Control Panel LCP 102 (Graphical)

**Ordering number:** 130B1107

VLT® Wireless Communication Panel LCP 103

**Ordering number:** 134B0460

LCP Panel Mounting Kit

**Ordering number for IP20 enclosure**

130B1113: With fasteners, gasket, graphical LCP and 3 m cable

130B1114: With fasteners, gasket, numerical LCP and 3 m cable

130B1117: With fasteners, gasket and without LCP and with 3 m cable

130B1170: With fasteners, gasket and without LCP

**Ordering number for IP55 enclosure**

130B1129: With fasteners, gasket, blind cover and 8 m "free end" cable

LCP Remote Mounting Kit

**Ordering number:**

134B5223 – Kit with 3 m cable:

134B5224 – Kit with 5 m cable

134B5225 – Kit with 10 m cable

## Accessories

PROFIBUS SUB-D9 Adapter

IP20, A2 and A3

**Ordering number:** 130B1112

Option Adapter

**Ordering number:** 130B1130 standard, 130B1230 coated

Adapter Plate for VLT® 3000 and VLT® 5000

**Ordering number:** 130B0524 – to be used only for IP20/NEMA type 1 units up to 7.5 kW

USB Extension

**Ordering number:**

130B1155: 350 mm cable

130B1156: 650 mm cable

IP21/Type 1 (NEMA 1) kit

**Ordering number**

130B1121: For enclosure size size A1

130B1122: For enclosure size size A2

130B1123: For enclosure size size A3

130B1187: For enclosure size size B3

130B1189: For enclosure size size B4

130B1191: For enclosure size size C3

130B1193: For enclosure size size C4

NEMA 3R outdoor weather shield

**Ordering number**

176F6302: For enclosure size size D1h

176F6303: For enclosure size size D2h

NEMA 4X outdoor weather shield

**Ordering number**

130B4598: For enclosure size size A4, A5, B1, B2

130B4597: For enclosure size size C1, C2

Motor connector

**Ordering number:**

130B1065: enclosure size A2 to A5 (10 pieces)

Mains connector

**Ordering number:**

130B1066: 10 pieces mains connectors IP55

130B1067: 10 pieces mains connectors IP20/21

Relays 1 terminal

**Ordering number:** 130B1069 (10 pieces 3 pole connectors for relay 01)

Relays 2 terminal

**Ordering number:** 130B1068 (10 pieces 3 pole connectors for relay 02)

Control card terminals

**Ordering number:** 130B0295

VLT® Leakage Current Monitor Module RCMB20/RCMB35

**Ordering number:**

130B5645: A2-A3

130B5764: B3

130B5765: B4

130B6226: C3

130B5647: C4

## PC software

VLT® Motion Control Tool MCT 10

VLT® Motion Control Tool MCT 31

Danfoss HCS Harmonic Calculation Software

VLT® Energy Box

Danfoss ecoSmart™





# Accessory compatibility with enclosure size

Overview for enclosure sizes D, E and F only

Enclosure size	Typecode position	D1h/ D2h	D3h/ D4h	D5h/ D7h	D6h/ D8h	D1n/ D2n	E1h/ E2h	E3h/ E4h	E9	F1/F2	F3/F4 (w/ options cabinet)	F8	F9 (w/ options cabinet)	F10/ F12	F11/F13 (w/options cabinet)
Enclosure with corrosion-resistant back channel	4	-	□	-	-	-	□	□	-	□	□	-	-	-	-
Mains shielding	4	□	-	□	□	□	□	-	□	■	■	■	■	■	■
Space heaters and thermostat	4	□	-	□	□	-	□	-	-	□	□	-	-	□	□
Cabinet light with power outlet	4	-	-	-	-	-	-	-	-	□	□	-	-	□	□
RFI filters (+)	5	□	□	□	□	□	□	□	□	-	□	-	□	-	□
Insulation Resistance Monitor (IRM)	5	-	-	-	-	-	-	-	-	-	□	-	□	-	□
Residual Current Device (RCD)	5	-	-	-	-	-	-	-	-	-	□	-	□	-	□
Brake Chopper (IGBTs)	6	-	□	□	□	□	□	□	□	□	□	□	□	□	□
Safe Torque Off with Pilz Safety Relay	6	□	□	□	□	□	□	□	□	□	□	□	□	□	□
Regeneration terminals	6	-	□	□	□	□	□	□	□	□	□	□	□	□	□
Common Motor Terminals	6	■	■	■	■	■	■	■	■	□	□	■	■	□	□
Emergency Stop with Pilz Safety Relay	6	-	-	-	-	-	-	-	-	-	□	-	-	-	-
Safe Torque Off + Pilz Safety Relay	6	-	-	-	-	-	-	-	-	□	□	□	□	□	□
No LCP	7	□	□	□	□	-	□	□	-	-	-	-	-	-	-
VLТ* Control Panel LCP 101 (Numeric)	7	□	□	□	□	-	-	-	-	-	-	-	-	-	-
VLТ* Control Panel LCP 102 (Graphical)	7	□	□	□	□	■	■	■	■	■	■	■	■	■	■
Fuses	9	□	□	□	-	□	■	□	□	□	□	□	□	□	□
Load sharing terminals	9	-	□	-	-	-	-	□	-	□	□	-	-	-	-
Fuses + load sharing terminals	9	-	□	-	-	-	-	□	-	□	□	-	-	-	-
Disconnect	9 <sup>(1)</sup>	-	-	-	□	□	□	-	□	-	□	-	□	-	□
Circuit breakers	9 <sup>(1)</sup>	-	-	-	□	-	-	-	-	-	□	-	-	-	-
Contactors	9 <sup>(1)</sup>	-	-	-	□	-	-	-	-	-	□	-	-	-	-
Manual motor starters	10	-	-	-	-	-	-	-	-	□	□	-	-	□	□
30 A, fuse-protected terminals	10	-	-	-	-	-	-	-	-	□	□	-	-	□	□
24V DC supply	11	-	-	-	-	-	-	-	-	□	□	-	-	□	□
External temperature monitoring	11	-	-	-	-	-	-	-	-	□	□	-	-	□	□
Heat sink access panel	11	□	□	□	□	-	□	□	-	-	-	-	-	-	-
NEMA 3R ready drive	11	□	-	-	-	-	-	-	-	-	-	-	-	-	-

<sup>(1)</sup> Options supplied with fuses

<sup>(+)</sup> Not available in 690 V

□ Optional

■ Standard

## Enclosure with corrosion-resistant back channel

For additional protection from corrosion in harsh environments, units can be ordered in an enclosure that includes a stainless steel back channel, heavier plated heat sinks and an upgraded fan.

This option is recommended in salt-air environments, such as those near the ocean.

## Mains shielding

Lexan® shielding can be mounted in front of incoming power terminals and the input plate to protect from accidental contact when the enclosure door is open.

## Space heaters and thermostat

Mounted in the cabinet interior of drives with enclosure sizes D and F and controlled via an automatic thermostat, space heaters controlled via an automatic thermostat prevent condensation inside the enclosure.

The thermostat default settings turn on the heaters at 10 °C (50 °F) and turn them off at 15.6 °C (60 °F).

## Cabinet light with power outlet

A light can be mounted on the cabinet interior of drives with enclosure size F, to increase visibility during servicing and maintenance. The light housing includes a power outlet for temporarily powering laptop computers or other devices. Available in two voltages:

- 230 V, 50 Hz, 2.5 A, CE/ENEC
- 120 V, 60 Hz, 5 A, UL/cUL

## RFI filters

VLT® Series drives feature integrated Class A2 RFI filters as standard. If additional levels of RFI/EMC protection are required, they can be obtained using optional Class A1 RFI filters, which provide suppression of radio frequency interference and electromagnetic radiation in accordance with EN 55011.

On drives with enclosure size F, the Class A1 RFI filter requires the addition of the options cabinet.

Marine-use RFI filters are also available.

## Insulation Resistance Monitor (IRM)

Monitors the insulation resistance in ungrounded systems (IT systems in IEC terminology) between the system phase conductors and ground. There is an ohmic pre-warning and a main alarm setpoint for the insulation level. Associated with each setpoint is an SPDT alarm relay for external use. Only one insulation resistance monitor can be connected to each ungrounded (IT) system.

- Integrated into the drive's Safe Torque Off circuit
- LCD display of insulation resistance
- Fault memory
- INFO, TEST and RESET key

## Residual Current Device (RCD)

Uses the core balance method to monitor ground fault currents in grounded and high-resistance grounded systems (TN and TT systems in IEC terminology). There is a pre-warning (50% of main alarm setpoint) and a main alarm setpoint. Associated with each setpoint is an SPDT alarm relay for external use. Requires an external "window-type" current transformer (supplied and installed by customer).

- Integrated into the drive's Safe Torque Off circuit
- IEC 60755 Type B device monitors, pulsed DC, and pure DC ground fault currents
- LED bar graph indicator of the ground fault current level from 10-100% of the setpoint
- Fault memory
- TEST / RESET key

## Safe Torque Off with Pilz Safety Relay

Available for drives with enclosure size F. Enables the Pilz Relay to fit in the enclosure without requiring an options cabinet.

## Emergency Stop with Pilz Safety Relay

Includes a redundant 4-wire emergency stop pushbutton mounted on the front of the enclosure, and a Pilz relay that monitors it in conjunction with the drive's Safe Torque Off circuit and contactor position. Requires a contactor and the options cabinet for drives with enclosure size F.

## Brake Chopper (IGBTs)

Brake terminals with an IGBT brake chopper circuit allow for the connection of external brake resistors. For detailed data on brake resistors please see the VLT® Brake Resistor MCE 101 Design Guide, MG.90.Oxyy, available at <http://drivesliterature.danfoss.com/>

## Regeneration terminals

Allow connection of regeneration units to the DC bus on the capacitor bank side of the DC-link reactors for regenerative braking. The enclosure size F regeneration terminals are sized for approximately 50% of the power rating of the drive. Consult the factory for regeneration power limits based on the specific drive size and voltage.

## Load sharing terminals

These terminals connect to the DC-bus on the rectifier side of the DC-link reactor and allow for the sharing of DC bus power between multiple drives. For drives with enclosure size F, the load sharing terminals are sized for approximately 33% of the power rating of the drive. Consult the factory for load sharing limits based on the specific drive size and voltage.

## Disconnect

A door-mounted handle allows for the manual operation of a power disconnect switch to enable and disable power to the drive, increasing safety during servicing. The disconnect is interlocked with the cabinet doors to prevent them from being opened while power is still applied.

## Circuit breakers

A circuit breaker can be remotely tripped, but must be manually reset. Circuit breakers are interlocked with the cabinet doors to prevent them from being opened while power is still applied. When a circuit breaker is ordered as an option, fuses are also included for fast-acting current overload protection of the AC drive.

## Contactors

An electrically controlled contactor switch allows for the remote enabling and disabling of power to the drive. An auxiliary contact on the contactor is monitored by the Pilz Safety Module if the IEC Emergency Stop option is ordered.

## Manual motor starters

Provide 3-phase power for electric cooling blowers that are often required for larger motors. Power for the starters is provided from the load side of any supplied contactor, circuit breaker or disconnect switch. If a Class 1 RFI filter option is ordered, the input side of the RFI provides the power to the starter. Power is fused before each motor starter and is off when the incoming power to the drive is off. Up to two starters are allowed. If a 30 A, fuse-protected circuit is ordered, then only one starter is allowed. Starters are integrated into the drive's Safe Torque Off circuit.

Unit features include:

- Operation switch (on/off)
- Short circuit and overload protection with test function
- Manual reset function

## 30 A, fuse-protected terminals

- 3-phase power matching incoming mains voltage for powering auxiliary customer equipment
- Not available if two manual motor starters are selected
- Terminals are off when the incoming power to the drive is off
- Power for the fused-protected terminals will be provided from the load side of any supplied contactor, circuit breaker, or disconnect switch. If a Class 1 RFI filter option is ordered, the input side of the RFI provides the power to the starter.



## Common Motor Terminals

The common motor terminal option provides the bus bars and hardware required to connect the motor terminals from the paralleled inverters to a single terminal (per phase) to accommodate the installation of the motor-side top entry kit.

This option is also recommended to connect the output of a drive to an output filter or output contactor. The common motor terminals eliminate the need for equal cable lengths from each inverter to the common point of the output filter (or motor).

### 24 V DC supply

- 5 A, 120 W, 24 V DC
- Protected against output overcurrent, overload, short circuits, and overtemperature
- For powering customer-supplied accessory devices such as sensors, PLC I/O, contactors, temperature probes, indicator lights and/or other electronic hardware
- Diagnostics include a dry DC-ok contact, a green DC-ok LED and a red overload LED
- Version with RTC available

### External temperature monitoring

Designed for monitoring temperatures of external system components, such as the motor windings and/or bearings. Includes eight universal input modules plus two dedicated thermistor input modules. All ten modules are integrated into the drive's Safe Torque Off

circuit and can be monitored via a fieldbus network, which requires the purchase of a separate module/bus coupler. A Safe Torque Off brake option must be ordered when selecting external temperature monitoring.

### Universal inputs (5)

Signal types:

- RTD inputs (including Pt100), 3-wire or 4-wire
- Thermocouple
- Analog current or analog voltage
- Additional features:
  - One universal output, configurable for analog voltage or analog current
  - Two output relays (N.O.)
  - Dual-line LC display and LED diagnostics
  - Sensor lead wire break, short circuit and incorrect polarity detection
  - Interface set-up software
  - If 3 PTC are required, an MCB 112 control card option must be added.

Additional external temperature monitors:

- This option is available in case you need more than the MCB 114 and MCB 112 provides.

### VLT® Control Panel LCP 101 (Numeric)

- Status messages
- Quick menu for easy commissioning
- Parameter setting and adjusting
- Hand-operated start/stop function or selection of Automatic mode
- Reset function

**Ordering number**

130B1124

### VLT® Control Panel LCP 102 (Graphical)

- Multi-language display
- Quick menu for easy commissioning
- Full parameter back-up and copy function
- Alarm logging
- Info key explains the function of the selected item on display
- Hand-operated start/stop or selection of Automatic mode
- Reset function
- Trend graphing

**Ordering number**

130B1107

### VLT® Wireless Communication Panel LCP 103

- Full access to the drive
- Real-time error messages
- PUSH notifications for alarms/warnings
- Safe and secure WPA2 encryption
- Intuitive parameter functionalities
- Live graphs for monitoring and fine tuning
- Multi-language support
- Upload or download parameter file to the built-in memory or to your smartphone

**Ordering number**

134B0460

# Loose kits for enclosure sizes **D**, **E** and **F**

Kit	Available for following enclosure sizes
NEMA 3R outdoor weather shield	D1h, D2h
USB in the door kit	D1h, D2h, D3h, D4h, D5h, D6h, D7h, D8h, E1h, E2h, E3h, E4h, F
Enclosure size F top entry kit motor cables	F
Enclosure size F top entry kit mains cables	F
Common motor terminal kits	F1/F3, F2/F4
Adapter plate	D1h, D2h, D3h, D4h
Back-channel duct kit	D1h, D2h, D3h, D4h, E3h, E4h
NEMA 3R Rittal and welded enclosures	D3h, D4h
Back-channel cooling kits for non-Rittal enclosures	D3h, D4h
Back-channel cooling kit (in-bottom/out-top)	D1h, D2h, D3h, D4h, E3h, E4h
Back-channel cooling kit (in-bottom/out-back)	
Back-channel cooling kit (in-back/out-back)	D1h, D2h, D3h, D4h, E3h, E4h, F
Back-channel cooling kit (in-back/out-top)	
Telescopic back-channel cooling kit	E1h, E2h, E3h, E4h
Pedestal kit with in-back/out-back cooling	D1h, D2h
Pedestal kit	D1h, D2h, D5h, D6h, D7h, D8h
Top entry of fieldbus cables	D3, D4, D1h-D8h
Top-entry Sub D9 connector kit for PROFIBUS option	D1h-D8h, E1h-E4h
LCP Remote Mounting Kit	Available for the full product range
Ground bar kit	E1h, E2h
Multiwire kit	D1h, D2h
L-shaped motor busbars kit	D1h, D2h, D3h, D4h
Common mode filter	D1h, D2h, D3h, D4h, D5h, D6h, D7h, D8h
Space heater kit	E1h, E2h
Tall pedestal kit	
Cable clamp kit	E3h, E4h

## NEMA 3R outdoor weather shield

Designed to be mounted over the VLT® drive to protect from direct sun, snow and falling debris. Drives used with this shield must be ordered from the factory as "NEMA 3R Ready". This is an enclosure option in the type code – E5S.

### Ordering number

D1h.....	176F6302
D2h.....	176F6303

## USB in the door kit

Available for all enclosure sizes, this USB extension cord kit allows access to the drive controls via laptop computer without opening the drive.

The kits can only be applied to drives manufactured after a certain date. Drives built prior to these dates do not have the provisions to accommodate the kits. Reference the following table to determine which drives the kits can be applied to.

### Ordering number

Enclosure sizes D.....	176F1784
Enclosure sizes E.....	176F1784
Enclosure sizes F.....	176F1784

## Enclosure size F top entry kit motor cables

To use this kit, the drive must be ordered with the common motor terminal option. The kit includes everything to install a top entry cabinet on the motor side (right side) of an F size enclosure.

### Ordering number

F1/F3, 400 mm .....	176F1838
F1/F3, 600 mm .....	176F1839
F2/F4 400 mm .....	176F1840
F2/F4, 600 mm .....	176F1841
F8, F9, F10, F11, F12, F13 .....	Contact factory

## Enclosure size F top entry kit mains cables

The kits include everything required to install a top entry section onto the mains side (left side) of an F size enclosure.

### Ordering number

F1/F2, 400 mm .....	176F1832
F1/F2, 600 mm .....	176F1833
F3/F4 with disconnect, 400 mm .....	176F1834
F3/F4 with disconnect, 600 mm .....	176F1835
F3/F4 without disconnect, 400 mm .....	176F1836
F3/F4 without disconnect, 600 mm .....	176F1837
F8, F9, F10, F11, F12, F13 .....	Contact factory

## Common motor terminal kits

The common motor terminal kits provide the busbars and hardware required to connect the motor terminals from the paralleled inverters to a single terminal (per phase) to accommodate the installation of the motor-side top entry kit. This kit is equivalent to the common motor terminal option of a drive. This kit is not required to install the motor-side top entry kit if the common motor terminal option was specified when the drive was ordered.

This kit is also recommended to connect the output of a drive to an output filter or output contactor. The common motor terminals eliminate the need for equal cable lengths from each inverter to the common point of the output filter (or motor).

### Ordering number

F1/F2, 400 mm .....	176F1832
F1/F2, 600 mm .....	176F1833

## Adapter plate

The adapter plate is used to replace an old enclosure size D drive with the new enclosure size D drive, using the same mounting.

### Ordering number

D1h/D3h adapter plate to replace D1/D3 drive.....	176F3409
D2h/D4h adapter plate to replace D2/D4 drive.....	176F3410

## Back-channel duct kit

Back-channel duct kits are offered for conversion of enclosure sizes D and E. They are offered in two configurations – in-bottom/out-top venting and top only venting. Available for enclosure sizes D3h and D4h.

### Ordering number top and bottom

D3h kit 1800 mm without pedestal.....	176F3627
D4h kit 1800 mm without pedestal.....	176F3628
D3h Kit 2000 mm with pedestal.....	176F3629
D4h Kit 2000 mm with pedestal.....	176F3630

## NEMA 3R Rittal and welded enclosures

The kits are designed to be used with the IP00/IP20/Chassis drives to achieve an ingress protection rating of NEMA 3R or NEMA 4. These enclosures are intended for outdoor use to provide a degree of protection against inclement weather.

### Ordering number for NEMA 3R (welded enclosures)

D3h back-channel cooling kit (in back out back).....	176F3521
D4h back-channel cooling kit (in back out back).....	176F3526

### Ordering number for NEMA 3R (Rittal enclosures)

D3h back-channel cooling kit (in back out back).....	176F3633
D4h back-channel cooling kit (in back out back).....	176F3634

## Back-channel cooling kits for non-Rittal enclosures

The kits are designed to be used with the IP20/Chassis drives in non-Rittal enclosures for in-back/out-back cooling. Kits do not include plates for mounting in the enclosures.

### Ordering number

D3h.....	176F3519
D4h.....	176F3524

### Ordering number for corrosion resistant

D3h.....	176F3520
D4h.....	176F3525

## Back-channel cooling kit (in-bottom/out-back)

Kit for directing the back-channel air flow in the bottom of the drive and out the back.

### Ordering number

D1h/D3h.....	176F3522
D2h/D4h.....	176F3527

### Ordering number corrosion resistant

D1h/D3h.....	176F3523
D2h/D4h.....	176F3528

## Back-channel cooling kit (in-back/out-back)

These kits are designed to be used for redirecting the back-channel air flow. Factory back-channel cooling directs air in the bottom of the drive and out the top. The kit allows the air to be directed in and out the back of the drive.

### Ordering number for in-back/out-back cooling kit

D1h.....	176F3648
D2h.....	176F3649
D3h.....	176F3625
D4h.....	176F3626
D5h/D6h.....	176F3530
D7h/D8h.....	176F3531

### Ordering number for corrosion resistant

D1h.....	176F3656
D2h.....	176F3657
D3h.....	176F3654
D4h.....	176F3655

### Ordering number for VLT® Low Harmonic Drives

D1n.....	176F6482
D2n.....	176F6481
E9.....	176F3538
F18.....	176F3534

### Ordering number for VLT® Advanced Active Filter AAF006

D14.....	176F3535
----------	----------

## Telescopic back-channel cooling kit

Back-channel cooling kits for IP20/Chassis drives allow the heat sink air of the drive to be directed out of the panel in which the drive is installed. The new telescopic provides more flexibility and easier installation to fit inside the panel.

The kits are supplied in almost pre-assembled condition, and include a gland plate that fits standard Rittal enclosures.

### Ordering numbers for D-frames:

D3h (in-bottom/out-back).....	176F6760
D4h (in-bottom/out-back).....	176F6761

### Ordering numbers for E-frames:

E3h (in bottom/out top)	
600 mm bottom plate .....	176F6606
E3h (in bottom/out top)	
800 mm bottom plate .....	176F6607
E4h (in bottom/out top)	
800 mm bottom plate .....	176F6608
E1h (in-back/out-back) .....	176F6617
E2h (in-back/out-back).....	176F6618
E3h (in back/out back).....	176F6610
E4h (in back/out back).....	176F6611
E3h (in bottom/out back)	
600 mm bottom plate .....	176F6612
E3h (in bottom/out back)	
800 mm bottom plate .....	176F6613
E4h (in bottom/out back)	
800 mm bottom plate .....	176F6614
E3h (in back/out top).....	176F6615
E4h (in back/out top).....	176F6616

## Pedestal kit with in-back/out-back cooling

See additional documents 177R0508 and 177R0509.

### Ordering number

D1h 400 mm kit.....	176F3532
D2h 400 mm kit.....	176F3533

## Pedestal kit

The pedestal kit is a 400 mm high pedestal for enclosure sizes D1h, D2h, E1h and E2h and 200 mm high for enclosure sizes D5h and D6h, that allows the drives to be floor mounted. The front of the pedestal has openings for input air to cool the power components.

### Ordering number

D1h 400 mm kit.....	176F3631
D2h 400 mm kit.....	176F3632
D5h/D6h 200 mm kit.....	176F3452
D7h/D8h 200 mm kit.....	176F3539
E1h 400 mm kit.....	176F6764
E2h 400 mm kit.....	176F6763

## Input-plate option kit

Input-plate option kits are available for enclosure sizes D and E. The kits can be ordered to add fuses, disconnect/fuses, RFI, RFI/fuses and RFI/disconnect/fuses. Please consult the factory for kit ordering numbers.

## Top entry of fieldbus cables

The top entry kit provides the ability to install fieldbus cables through the top of the drive. The kit is IP20 when installed. If an increased rating is desired, a different mating connector can be used.

### Ordering number

D1h-D8h.....	176F3594
--------------	----------

## Top-entry Sub D9 connector kit for PROFIBUS option

This kit provides a top-entry sub D9 PROFIBUS connection that maintains the IP protection rating of the drive up to IP54.

### Ordering number

176F1742
----------

## LCP Remote Mounting Kit

The LCP Remote Mounting Kit offers an easy-to-install, IP54 design which you can mount on panels and walls of 1-90 mm thickness. The front cover blocks the sunlight for convenient programming. The closed cover is lockable to prevent tampering, while keeping the On/Warning/Alarm LEDs visible. It is compatible with all VLT® Local Control Panel options.

### Ordering number for IP20 enclosure

3 m cable length.....	134B5223
5 m cable length.....	134B5224
10 m cable length.....	134B5225

## Ground bar kit

More grounding points for E1h and E2h drives. The kit includes a pair of ground bars for installation inside the enclosure.

### Ordering number

E1h/E2h.....	176F6609
--------------	----------

## Multi-wire kit

The kit is designed to connect the drive with multi-wire cable for each motor phase or mains phase.

### Ordering number

D1h.....	176F3817
D2h.....	176F3818

## L-shaped busbar kit

The kit allows multi-wires mounting for each phase of mains or motor. D1h, D3h drives can have 3 connections per phase of 50 mm<sup>2</sup> and D2h, D4h can accommodate 4 connections per phase of 70 mm<sup>2</sup>.

### Ordering number

D1h/D3h L-shaped motor busbars kit.....	176F3812
D2h/D4h L-shaped motor busbars kit.....	176F3810
D1h/D3h L-shaped mains busbars kit.....	176F3854
D2h/D4h L-shaped mains busbars kit.....	176F3855

## Common mode cores kit

Designed as a subassembly of 2 or 4 common mode cores to reduce bearing currents. Depending on the voltage and length of the cables, the number of cores change.

### Ordering number

Common mode filter T5/50 m.....	176F6770
Common mode filter T5/100 m or T7.....	176F3811

## Space heater kit

The space heater kit includes a pair of 40 W anti-condensation heaters for installation inside E1h and E2h enclosures.

### Ordering number

E1h, E2h.....	176F6748
---------------	----------

## Tall pedestal kit

The tall pedestal kit contains all parts required to install the tall pedestal for E1h and E2h drives. The tall pedestal is 400 mm (15.7 in) and replaces the standard pedestal that ships with the drive.

### Ordering number

Tall pedestal kit for E1h.....	176F6764
Tall pedestal kit for E2h.....	176F6763

## Cable clamp kit

The kit includes all parts required to install cable clamps for mains, motor, and control wiring.

### Ordering number

E3h.....	176F6746
E4h.....	176F6747







# Fresh, clean water is a basic element of civilization – vital for agriculture and important for industries

Danfoss provides game-changing concepts to extend our precious water and energy resources. From desalination via reverse osmosis, to traditional water production, water distribution and wastewater treatment, Danfoss gives

you energy-efficient solutions. Today, it's even possible to generate energy during water processing, fulfilling the energy need of the entire water cycle.

Wastewater treatment plant **generates surplus power**

Marselisborg Wastewater Treatment Plant, Denmark



Read the case study

Water treatment works **saves £0.3 million in running costs**

Chertsey Water Treatment works of Affinity Water, United Kingdom



Read the case study

Racetrack hydro system ensures **exceptional performance**

Enzo and Dino Ferrari International Racetrack, Italy



Read the case study

Discover more case studies for the VLT® AQUA Drive here:  
<https://www.danfoss.com/en/markets/water-and-wastewater/>

Follow us and learn more about AC drives

