

Selection Guide | VLT® AutomationDrive FC 300 Series

Versatile, reliable and consistently awesome



Intelligence

to empower
your industrial
applications



Content

Seamlessly into the future	4	Customized commissioning experience	19
Consistently awesome.....	5	Modular simplicity – A, B and C enclosures.....	20
Designed for easy integration in any application	6	VLT® Wireless Communication Panel LCP 103	21
Designed with fast and easy start-up in mind	7	High-power modularity – D, E and F enclosures.....	22
Extensive functionality for high-performance operation.....	8	Engineered for cost savings via intelligent heat management, compactness and protection.....	24
Leveraging digitalization to reduce maintenance costs.....	9	Ruggedized for extra protection.....	24
Flexible, modular and adaptable. Built to last.....	10	Optimize performance and grid protection.....	26
Stand-alone drives, enclosed drives, modules.....	12	DrivePro® Life Cycle service products.....	27
Application flexibility to boost your business	13	Connection example.....	28
Integrated motion controller – for positioning and synchronization applications.....	14	Technical data.....	29
Increase precision, accuracy and speed.....	16	Electrical data – A, B, and C enclosures.....	30
Tailored safety	17	Dimensions enclosure sizes A, B and C.....	34
Free to connect.....	18	Ordering typecode for A, B and C enclosures	35



Consistency, reliability, versatility.

And all the power
you need.

Chosen for its versatility, respected for its reliability, the VLT® AutomationDrive has been providing consistently awesome performance for almost half a century.

It may have been around for a while. But that doesn't mean it hasn't evolved. Far from it. The VLT® AutomationDrive is now tougher and more intelligent than it has ever been before.

Built to last, this robust drive operates effectively and reliably even with the most demanding applications and in the most challenging environments. Read on to find out about the new generation E-frames and the lower temperature rating.

As with all Danfoss drives, the VLT® AutomationDrive is motor independent giving you the power to choose the motor that best suits your application.

Packed with innovation, it features both hardware and software enhancements that maximize performance, and a new Ethernet platform for improved communication.

VLT® AutomationDrive takes full advantage of all that the new digital age has to offer to ensure it completely fulfills the requirements of your applications and optimizes your processes throughout the entire lifecycle.

Electrical data – D, E and F enclosures.....	36
Dimensions enclosure sizes D, E and F.....	38
Electrical data and dimensions – VLT® 12-Pulse.....	39
Ordering typecode for D, E and F enclosures.....	42
Electrical data – VLT® Low Harmonic Drive and VLT® Advanced Active Filters.....	44
A options: Fieldbuses.....	46
B options: Functional extensions.....	47
C options: Motion control and relay card.....	49
D option: 24 V back-up power supply.....	49
Accessories.....	50
Power options.....	51
Accessory compatibility with enclosure size.....	52
Loose kits for enclosure sizes D, E and F.....	54



Seamlessly into the future

The fourth Industrial Revolution, or Industry 4.0, builds on the progress of automation by introducing elements of interconnectivity, data acquisition, machine learning and intelligent applications of analytics. AC drives play an important and powerful part in this transition by being the first point of interaction between sensors from the process, the motor in operation and communicating this information via communications bus to a central control location.

At Danfoss Drives, we live and breathe Industry 4.0, with the VLT® AutomationDrive representing the latest and best technologies in the

drives industry. When you choose the VLT® AutomationDrive, you can count on the intelligent drive functions, application know-how, proven quality and reliability, and the support you need to make a seamless transition into Industry 4.0 and beyond.

The VLT® AutomationDrive offers:

- Web-based configuration, Electronic Data Interchange (EDI), transparent order management
- Access to drawings, engineering diagrams, and ePlan macros
- Simulation tools such as Danfoss HCS for harmonic calculation and Danfoss ecoSmart™ for motor-drive system efficiency calculations
- Compatibility with all industry-leading motor and fieldbus technologies
- Embedded intelligence for adaptability to evolving application needs
- Flexible interface to the drive data from multiple access points including: directly at the drive, via mobile applications, through an integrated web server and via cloud connectivity



Consistently **awesome**

It's easy to sum up the qualities of the VLT® AutomationDrive in just two words – consistently awesome.

Throughout the entire lifecycle of your application, the VLT® AutomationDrive provides benefits that not only save you time and money, but also help optimize your process while providing the flexibility and reliability to meet your current and future demands.

Awesome versatility

Modular and adaptable, the VLT® AutomationDrive fits into any environment. It can be relied on to meet all your needs whether you have a single application or a variety of different ones.

Its cutting-edge thermal design and unique back-channel cooling for drives above 90 kW make VLT® AutomationDrive one of the most compact and cost-efficient drives in the market.

Simple start-up

VLT® AutomationDrive is robust and intelligent, but at the same time quick and easy to install and provides years of reliable operation.

Intelligent operation

VLT® AutomationDrive has a big brain ready to be put to work to control your applications effectively, efficiently and reliably.

High availability

Once installed, you can trust VLT® AutomationDrive to provide troublefree operation. New intelligent maintenance features and a range of DrivePro® services proactively improve productivity, performance and uptime.

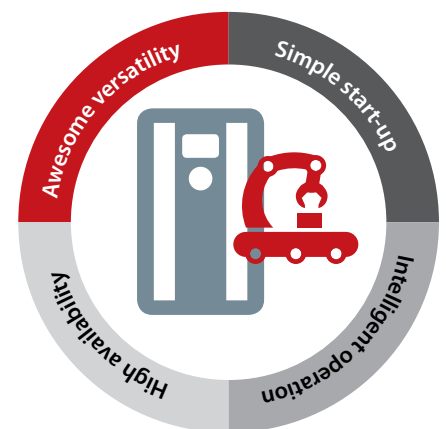

Do it differently

Know-how and experience

Proven quality

DrivePro® services

Awesome versatility

5

reasons to choose
the VLT® AutomationDrive

1. Fits in any environment
2. Modular and adaptable
3. Application flexibility
4. Reduced harmonic impact
5. Compact and efficient



Designed for easy integration in any application

Before any wires are connected or power is applied, your expectations of an AC drive determine whether or not it is the correct fit for your application. An awesome combination of functionality, suitability for your environment and the availability of comprehensive engineering tools make the VLT® AutomationDrive FC 300 Series an AC drive you can feel absolutely confident selecting no matter your needs.

Fits in any environment

VLT® AutomationDrive can be installed wherever it best suits your application – close to the motor, located centrally in an electrical panel or outdoors. Its wide variety of enclosure class, conformal coating and ruggedization options reduce maintenance costs and ensure reliable operation in a range of challenging environments. A wide operating temperature range of -25 °C to +50 °C adds additional peace of mind when your applications take your drive to the extremes.

Modular and adaptable

The VLT® AutomationDrive is built on a flexible, modular design concept that provides an extraordinarily versatile motor control solution. The drive is equipped with a wide range of industry features that enables optimal process control, higher quality output and reduced costs related to spare parts and service. The book-style mounting takes advantage of this modular construction principle, allowing for more drives to fit into less space.

Application flexibility

When you have a variety of applications, it's best to select an AC drive that you can count on to meet all your needs. Whether operating pumps, conveyors, palletizers or material treatment equipment, the VLT® AutomationDrive delivers the optimum control you want for reliable operation, all day long.

Reduced harmonic impact

The ability to predict the impact of adding AC drives to your facility is critical to keeping costs low. The Danfoss HCS tool allows you to calculate how much harmonic content to expect before you install your drive and avoid additional costs of harmonics and harmonic mitigation equipment on your facility. The availability of low harmonic drives, 12-pulse drives and low harmonic power options further minimizes harmonic impact.

Compact and efficient

When your application requires more power, you don't want to have to increase the space needed for an AC drive. Thanks to its cutting-edge thermal design, VLT® AutomationDrive is one of the most compact air-cooled drives on the market in the range of 90 kW to 800 kW at 500 V. Combining this best-in-class power density with unique back-channel cooling further reduces costs associated with cooling while keeping the space required to a minimum.

Designed with fast and easy start-up in mind

Your choice of AC drive should reduce the time it takes to get your application up and running without sacrificing any features or functionality. The VLT® AutomationDrive FC 300 Series is designed to simplify every step in the start-up process – from wiring to programming to operation – and reliably deliver what you need for your application.

Easy installation

All I/O terminals are pluggable and spring-loaded and each has dual-connector configuration making wiring easy and flexible. Drives with high environmental enclosure ratings can also be ordered with pre-threaded cable gland openings to allow for an easy and reliable way to install your drive in harsh environments.

Dedicated application functionality

A versatile drive doesn't have to mean that your drive is complicated to commission. Application-dedicated functions in the VLT® AutomationDrive perfectly balance ease and robustness to deliver reliable performance regardless of the application. Features such as droop functionality for load sharing, integrated brake control for the safe operation of hoists and the integrated process controller for demand-based pumping help to save time and money during start-up.

Optimized motor control

Automatic Motor Adaptation (AMA) is a powerful algorithm that tests and adjusts the drive to the unique traits of your motor, improving overall control and operating efficiency. Enhancements to the AMA for both asynchronous and PM motors means the process takes place in just a few milliseconds without spinning the motor. This enhanced AMA II, running before every start, ensures that the motor parameters are always calibrated to the specific operating conditions increasing motor control accuracy.

Tailored and tested

Every VLT® AutomationDrive is delivered from the factory exactly as you have configured it. Every drive is built with care and completely tested at full load against an AC motor prior to shipping, with your selected options already installed, which ensures that your drive will operate just as you expect it to.

Powerful PC tools

The VLT® Motion Control Tool MCT 10 is a PC tool designed with your drive in mind. Powerful features, like the Motor Setup and Functional Safety Setup tools, allow fast and easy commissioning of your application. MCT 10 includes the VLT® Software Customizer. Use it to create tailored Smart Assisted Startup wizards for accurate commissioning of your drive; or to define a unique set of customer-specific initial values for common parameters that can be loaded in your drive to replace factory default values.

Simple start-up

5

reasons to choose the VLT® AutomationDrive

1. Easy installation
2. Dedicated application functionality
3. Optimized motor control
4. Tailored and tested
5. Powerful PC tools

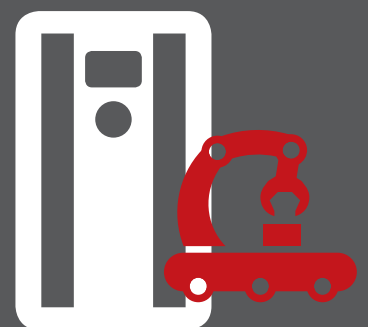

5

reasons to choose the VLT® AutomationDrive

1. Integrated Motion Controller
2. Robust four-quadrant control
3. Low noise operation
4. Easy PLC integration
5. High-efficiency operation



Extensive functionality for high-performance operation

The VLT® AutomationDrive FC 300 Series is installed in a wide variety of demanding applications and environments. Regardless of your application's needs, you can count on the VLT® AutomationDrive to deliver the capabilities for long, worry-free operation in even the most sensitive of environments.

Integrated Motion Controller

The performance of the VLT® AutomationDrive FC 302 is enhanced without complexity thanks to the Integrated Motion Controller (IMC). Providing motion functionality, high-precision scaled positioning and synchronizing tasks are simple to perform with or without encoder feedback, and commissioning is fast and safe. IMC is configurable by parameters – no special programming language is required. No additional modules or hardware are necessary.

Robust four-quadrant control

Applications, such as extruders and separators, place heavy demands on your AC drive. The VLT® AutomationDrive can meet your demands by providing reliable operation in both motoring and generating phases of operation. Accurate torque controls, especially through zero speed where the key challenges lie, result in smooth and continuous operation, saving both time and money.

Low noise operation

Unfiltered AC drives produce electromagnetic interference (EMI) – both conducted and emitted. This interference can negatively impact sensitive equipment. Built-in EMC/RFI protection with screened motor

cables to Residential Category C1 (to 50 m) and C2 (to 150 m) provides the ability to operate without additional and expensive filters, further increasing reliability and reducing interference with sensitive electronics.

Easy PLC integration

VLT® AutomationDrive is compatible with PROFINET, PROFIBUS DP-V1, DeviceNet, EtherNet/IP, EtherCAT, POWERLINK, CANopen and Modbus TCP protocols. All Ethernet options feature dual-ports with a built-in switch or HUB (POWERLINK). Some of the Ethernet technologies also support ring topology for higher availability and fast installation. Fieldbus configuration files, pretested function blocks and add-on instructions are available for easy, low-risk, integration into your PLC system.

High-efficiency operation

New standards in Ecodesign have been published focusing on energy efficiency of AC drives and drive-motor systems. As these standards increase the focus on the efficiency of AC drives worldwide, it's important to know that, with the VLT® AutomationDrive, you can count on having a foundation to meet these coming requirements. Using Danfoss ecoSmart™, you can quickly determine the IE class of your AC drive, the IES class of your specific motor-drive system and the part-load efficiency of your drive.

Leveraging **digitalization** to reduce **maintenance costs**

Unplanned downtime can be costly – both in terms of maintenance and lost production. Enhancements in the VLT® AutomationDrive provide more information about your devices and their performance, and a range of services optimizes their availability.

Intelligent troubleshooting

When something goes wrong with your process, the more data you have, the easier it is to pinpoint and quickly resolve the cause. New, intelligent maintenance features utilize the VLT® AutomationDrive's various sensors to record and store 2-3 seconds of real-time information around an Alarm, Warning or other defined trigger. This data from up to the last 20 events is then stored in the memory of the drive from where it can be retrieved and inspected within MCT 10. The addition of the Real Time Clock option allows the events to be time and date stamped, providing even more actionable data than ever before.

Wireless connectivity

The new VLT® Wireless Communication Panel LCP 103 provides wireless connectivity to your VLT® AutomationDrive using the MyDrive® Connect app for iOS and Android devices. It allows full and secure access to the drive for easy commissioning, operation and maintenance on your smart devices. Use the advanced LCP copy function to back up parameters to the storage of the LCP 103 or your smart device.

Remote access

Offsite accessibility allows for easier and faster access to both remote facilities or to large numbers of installed drives. Utilizing the integrated and modernized interface of the web server in the Ethernet-based communication options, each drive can be remotely accessed and monitored for operation and diagnostics purposes saving time and costs.

Intuitive maintenance

The Danfoss VLT® AutomationDrive features both preventive and predictive maintenance functions that provide for worry-free operation while reducing maintenance costs and unplanned downtime. Preventive maintenance functions can be used to schedule proactive maintenance alerts based on running time of the drive and triggering alerts, visible on the LCP and transferable over fieldbus. Predictive maintenance functions turn your drive into a configurable smart sensor that continuously monitors the condition of your motor and application based on standards and guidelines such as the ISO 13373 standard for Condition Monitoring and Diagnostics of Machines or the VDMA 24582 guideline for condition monitoring.

DrivePro® services

Danfoss Drives' comprehensive portfolio of services spans the entire lifecycle of your drives. As well as traditional service functions that improve productivity, performance and uptime, digitalization and the Internet of Things play valuable roles in our range of support and value-adding services. The drives themselves interact closely with their surrounding systems and processes. Built-in functionality allows them to collect and share data that is visible to maintenance personnel, Danfoss service teams, and 3rd-party service providers for fast and remote monitoring purposes.

Optimized
performance

5

reasons to choose
the VLT® AutomationDrive

1. Intelligent troubleshooting
2. Wireless connectivity
3. Remote access
4. Intuitive maintenance
5. DrivePro® services

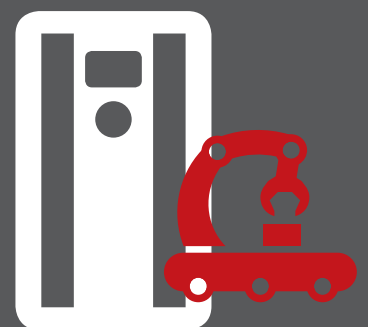

Flexible, modular and adaptable

Built to last

A VLT® AutomationDrive is built on a flexible, modular design to provide an extraordinarily versatile motor control solution. The drive is equipped with a wide range of industry features that enable optimal process control, higher quality output and reduce costs related to spare parts and service.

Free to equip

The VLT® AutomationDrive can optimally control nearly all standard industrial motor technologies, including Asynchronous, IPM, SPM, Synchronous Reluctance and PM assisted Synchronous Reluctance motors. This means that system designers, OEMs and end users are free to connect the drive to their selected

motor and remain confident that the system will perform to the highest possible standards.

As an independent manufacturer of AC drive solutions, you can count on Danfoss to support all commonly used motor types and foster ongoing development as new technologies emerge.

Speaks your language

When it comes to working with advanced technologies, such as AC drives, it is fairly easy to feel lost while navigating through hundreds of parameters. Using a graphical interface makes this process much easier; especially when it lists parameters in your native language. As many as 28 language options are available, including several Cyrillic, Arabic (right to left) and Asian options.

Additionally, the ability to save up to 50 user-selectable parameters further simplifies interactions with key parameter settings for your unique application.

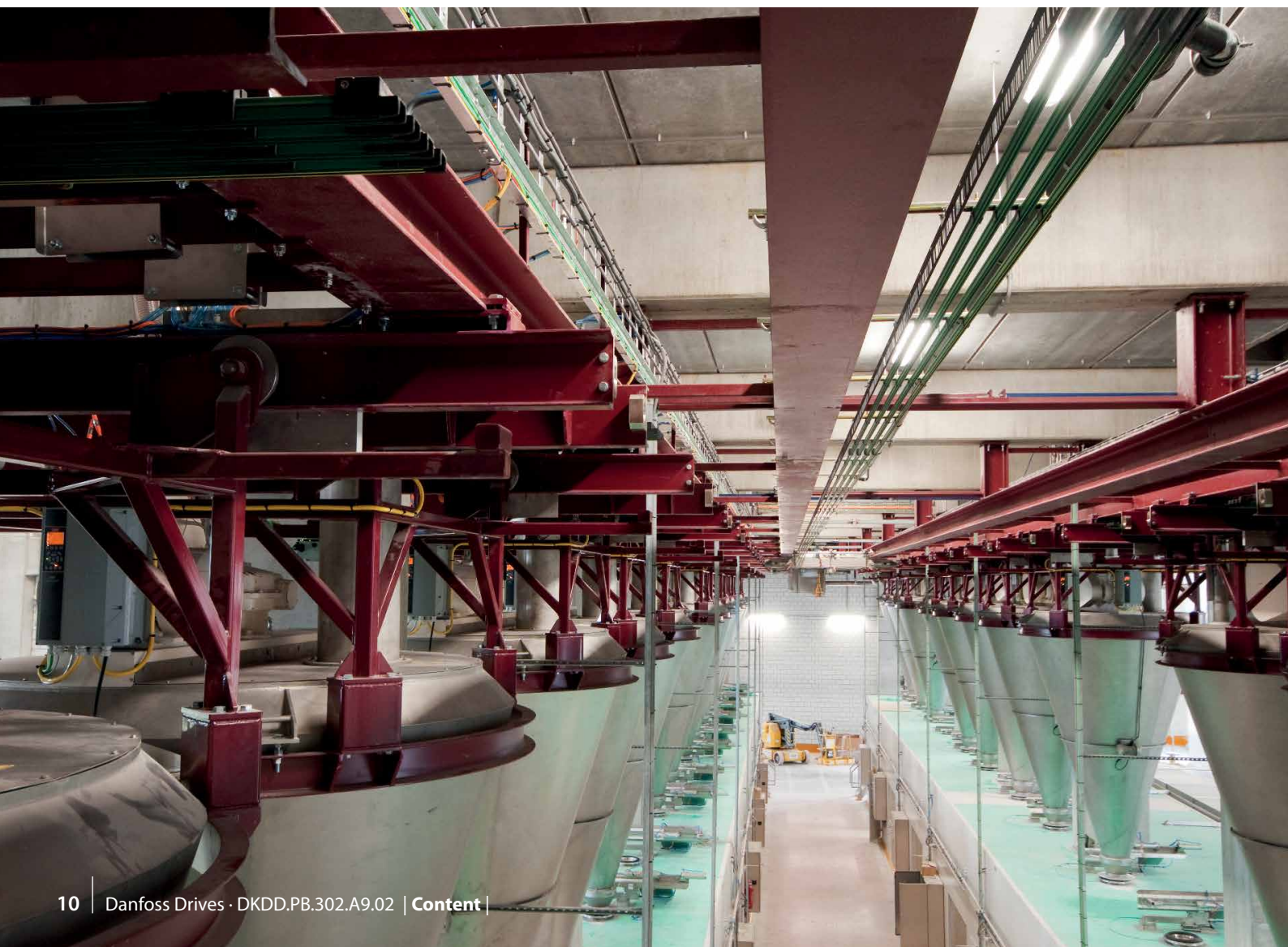

690 V

The 690 V versions of VLT® AutomationDrive FC 302 units for the power range from 1.1 kW up to 1400 kW can control motors down to 0.37 kW without step-down transformer. This enables you to choose from a broad variety of compact, reliable and efficient drives for demanding production facilities operating from 690 V mains networks.

Reduce costs with compact drives

A compact design and efficient heat management enable the drives to take up less space in control rooms and panels, thereby reducing initial costs. Compact dimensions are also an advantage in applications where drive space is restricted, making it possible for designers to develop smaller applications without being forced to compromise on protection and grid quality. For example, VLT®

AutomationDrive FC 302 in a D or E enclosure size is 25-68% smaller than equivalent drives.

Despite the compact dimensions, all units are nevertheless equipped with integrated DC link chokes and EMC filters, which help to reduce grid pollution and reduce cost and efforts for external EMC components and wiring.

The IP20 version is optimized for side-by-side mounting in cabinets to 50 °C without derating and features covered power terminals to prevent accidental contact. The AC drive can also be ordered with an optional brake chopper in the same package size. Control and power cables are fed in separately at the bottom.

The AC drives combine a flexible system architecture that allows them to be adapted to specific applications, with a uniform user interface across all

power classes. This allows you to adapt the drive to the exact needs of your specific application. As a result, project work and costs are subsequently reduced. The easy-to-use interface reduces training requirements. The integrated SmartStart guides users quickly and efficiently through the set-up process, resulting in fewer faults due to configuration and parameterization errors.

Power range

200-240 V

High overload

208 V 1.8-143 A I_{Nr} 0.25-37 kW,
230 V 1.8-170 A I_{Nr} 0.34-50 Hp

Normal overload

208 V 1.8-170 A I_{Nr} 0.25-45 kW
230 V 1.8-170 A I_{Nr} 0.34-60 Hp

380-500 V

High overload

400 V 1.3-1460 A I_{Nr} 0.37-800 kW,
460 V 1.2-1380 A I_{Nr} 0.5-1200 Hp

Normal overload

400 V 1.3-1720 A I_{Nr} 0.37-1000 kW
460 V 1.2-1530 A I_{Nr} 0.5-1350 Hp

525-600 V

High overload

575 V 1.7-100 A I_{Nr} 1-100 Hp

Normal overload

575 V 1.7-131 A I_{Nr} 1-120 Hp

525-690 V

High overload

575 V 1.6-1260 A I_{Nr} 1.5-1350 Hp
690 V 1.6-1260 A I_{Nr} 1.1-1200 kW

Normal overload

575 V 1.6-1415 A I_{Nr} 1.1-1550 Hp
690 V 1.6-1415 A I_{Nr} 1.1-1400 kW

Ingress protection ratings

IEC: IP00, IP20, IP21, IP54, IP55, IP66

UL: Chassis, Type 1, Type 12, Type 4X

Choose the adequate performance level

Special needs require special features and performance

	FC 301	FC 302
Power range [kW] 200-240 V	0.25-37	0.25-37
Power range [kW] 380-(480) 500 V	0.37-75 (480 V)	0.37-800 (500 V)
Power range [kW] 525-600 V	–	0.75-75
Power range [kW] 525-690 V	–	1.1-1400
Flux vector control	–	■
Cable length – screened/unscreened	25/50m (A1 only), 50/75m	150/300 m
Permanent magnet motor operation (w/wo feedback)	–	■
Safety function Safe Torque Off (STO – EN 61800-5-2)	Optional (A1 only)	■
Scan interval/response time ms	5	1
Output frequency (OL)	0.2-590 Hz	0-590 Hz, (600-1000 Hz)*
Max load (24 V DC) for analog output and control card [mA]	130	200
Programmable digital input	5 (4)	6 (4)
Programmable digital output changeable	1	2
Programmable relay output	1	2

* For frequency up to 1000 Hz please contact your local Danfoss partner.



Stand-alone drives

No need to compromise

Can't make space for a cabinet? Now there is no need. VLT® drives are so robust that you can mount them virtually anywhere, even right beside the motor. Equipped for the toughest of environments, they suit your application, no matter the requirement.

More uncompromising features:

- Enclosure types rated up to IP66/UL Type 4X
- Full EMC compliance according to international standards
- Ruggedized and coated PCBs
- Wide temperature range, operating from -25 °C to +50 °C without derating
- Motor cable lengths up to 150 m as standard, with uncompromised performance



Enclosed drives

Win time

VLT® drives are designed with the installer and operator in mind to save time on installation, commissioning and maintenance.

VLT® enclosed drives are designed for full access from the front. Just open the cabinet door and all components can be reached without removing the drive, even when mounted side by side.

More time-saving features:

- An intuitive user interface with an award-winning Local Control Panel (LCP) and common control platform that streamlines start-up and operating procedures
- Robust design and advanced controls make VLT® drives virtually maintenance free

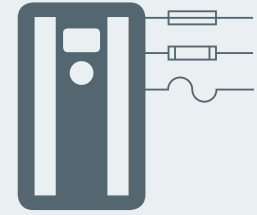

Modules

Win space

The compact design of high-power VLT® drives makes them easy to fit even in small spaces. Integrated filters, options and accessories provide additional capabilities and protection without increasing the enclosure size.

More space-saving features:

- Built-in DC link reactors for harmonic suppression eliminate the need for higher loss external AC line reactors
- Optional built-in RFI filters are available throughout the power range
- Optional input fuses and loadshare terminals are available within standard enclosures
- In addition to the many valuable features that VLT® drives offer as standard, there are numerous other control, monitoring and power options available in pre-engineered factory configurations





Application flexibility to boost your business

The VLT® AutomationDrive is optimized to create value for you, enabling maximum performance in all major applications irrespective of industry.

Applications	Industries												
	HVAC	Food and Beverage, Packaging	Water and Wastewater	Refrigeration	Marine and Offshore	Mining and Minerals	Metals	Chemical	Cranes and Hoists	Elevators and Escalators	Material handling	Oil and Gas	Textile
Pumps	■	■	■	■	■	■	■	■				■	■
Fans	■	■	■	■	■	■	■	■			■	■	■
Compressors	■	■	■	■	■	■	■	■				■	
Conveyors		■			■	■	■	■			■		
Process, material treatment		■	■			■	■	■				■	■
Mills, drums, kilns						■	■						
Winding, unwinding							■						■
Drilling						■						■	
Propulsion, thrusters					■								
Winches					■								
Vertical and horizontal movement		■	■		■	■	■	■	■	■		■	■
Power conversion generation, smart grids					■				■	■			
Positioning, synchronization		■					■	■			■		■



Integrated motion controller – for **positioning** and **synchronization** applications

Perform high-precision positioning and synchronization, simply using an AC drive. With the Integrated Motion Controller (IMC) functionality, the **VLT® AutomationDrive FC 302** replaces more complex positioning and synchronization controllers, to save time and cost.

Positioning and synchronization operations are typically performed using a servo drive or a motion controller. However, many of these applications do not actually require the dynamic performance available from a servo drive.

Therefore the FC 302 with IMC is a cost-effective, high-performance alternative to servo in single-axis positioning and synchronizing applications.

Use IMC for many applications that have been solved with servo drives until now, such as:

- Rotary tables
- Cutting machines
- Packaging machines

Use FC 302 to run an induction or PM motor with **or without motor feedback** – with no need for additional hardware. With sensorless control (no motor feedback) best performance is achieved with a PM motor. The performance of sensorless control of induction motors is however sufficient for less-demanding applications.

With IMC you **save time and cost:**

- No advanced programming and fewer components means fewer hours needed for engineering, installation and commissioning
- Save further cost for a feedback device, cabling and installation by using sensorless control
- To save cost for a home sensor and cabling, use the “homing on torque limit” function

The IMC solution provides **easy and safe set-up:**

- Configuration via parameters, with no advanced programming required. Reduced complexity will minimize the risk of errors

- To add more functionality, use the Smart Logic Controller (SLC), which is fully compatible with IMC
- To realign the home position during operation, use the “home synchronizing” function

Encoder-free

to save costs and reduce complexity

Positioning

In positioning mode, the drive controls movement over a specific distance (*relative positioning*) or to a specific target (*absolute positioning*). The drive calculates the motion profile based on target position, speed reference and ramp settings (see the examples in Fig. 1 and Fig. 2 on the right).

There are 3 positioning types using different references for defining the target position:

- **Absolute positioning**

Target position is relative to the defined zero point of the machine.

- **Relative positioning**

Target position is relative to the actual position of the machine.

- **Touch probe positioning**

Target position is relative to a signal on a digital input

This illustration (Fig. 3) shows the different resulting target with a set target position (reference) of 1000 and starting position of 2000 for each of the positioning types.

Synchronizing

In synchronizing mode, the drive follows the position of a master; multiple drives can follow the same master. The master signal can be an external signal, for example, from an encoder, a virtual master signal generated by a drive or master positions transferred by fieldbus. Gear ratio and position offset is adjustable by parameter.

Homing

With sensorless control and closed loop control with an incremental encoder, homing is required to create a reference for the physical position of

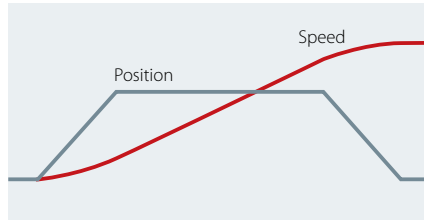

Fig. 1. Motion profile with linear ramps

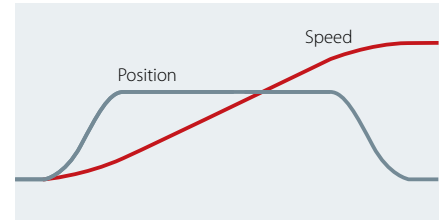

Fig. 2. Motion profile with S-ramps

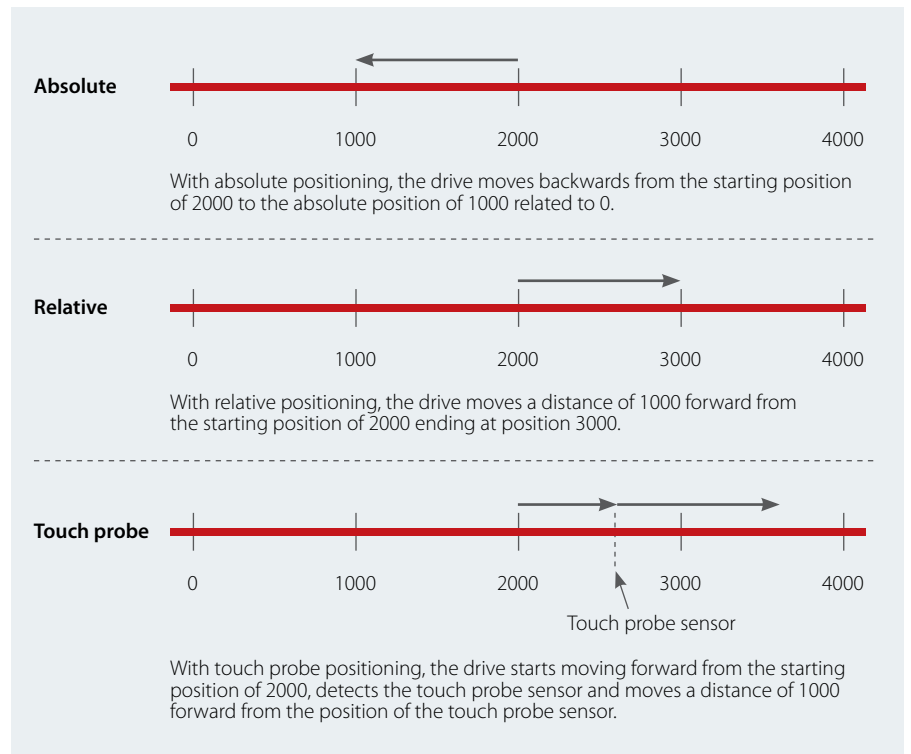

Fig. 3. IMC supports 3 positioning modes

the machine after power up. There are several home functions with and without sensor to choose from. The home synchronizing function can be used to continuously realign the home position during operation when there is some sort of slip in the system. For example in case of sensorless control with an induction motor or in case of slip in the mechanical transmission.



Increase precision, accuracy and speed

Expand the standard functionality of a VLT® AutomationDrive with energy-enhancing motion control options.

Increase productivity and performance

Replacing mechanical controls with intelligent, energy-saving electronic solutions is an effective way to reduce both installation and daily running costs.

The ability to set and control the packaging application with greater precision also reduces packaging errors and equipment breakdowns.

The result is a reliable, high-quality process that increases both productivity and bottom line performance.

Reduce installation costs

Replacing mechanics by electronic synchronizing or cam control increases flexibility while reducing costs. For example, electronic cam control, a standard feature in the VLT® Motion Control Option MCO 305, both adds

new functionalities and removes the need for mechanical cam discs and boxes.

Increase capacity

In other cases, manufacturers might want to increase the capacity of their packaging application. This can be achieved with the VLT® Synchronizing Controller MCO 350, which offers unparalleled synchronizing control and can be set up easily via the user-friendly control panel on the VLT® AutomationDrive.

As well as increasing the performance, the controller adds extra value by being an intelligent way to simplify the control system.

No matter which option you choose, the benefits of freedom of control and operational efficiency will provide a fast return on your investment.

Add flexibility to applications such as

- Printing lines
- Bottle washers
- Conveyor belts
- Packaging systems
- Material-handling systems
- Palletizers
- Indexing tables
- Storage systems
- Pick-and-place systems
- Positioning on the fly
- Foil wrapping
- Flow packing
- Filling and sealing
- Crane, lift and hoist applications
- Product-rejection systems
- Winder applications



Tailored **safety**

Protect both equipment and operators

The VLT® AutomationDrive FC 302 is delivered as standard with the STO (Safe Torque Off) function in compliance with ISO 13849-1 PLd and SIL2, according to IEC 61508/IEC 62061. This safety function can be extended to include SS1, SLS, SMS, safe jog mode, etc. with the VLT® Safety Option MCB 150 Series. The speed monitoring functions are available both with and without speed feedback.

VLT® Safety Option MCB 150 and MCB 151

The MCB 150 and MCB 151 can be integrated directly in the AC drive and is prepared for future connection to common safety bus systems. The

module is certified according to ISO 13849-1 up to PLd as well as IEC 61508/IEC 62061 up to SIL2 and provides SS1 and SLS (SMS) functionality. The option can be used in low and high demand applications. SS1 offers ramp and time based functionality. SLS can be configured both with and without ramp down on activation.

VLT® Safety Option MCB 152

The VLT® Safety Option MCB 152 operates the safety functions of an AC drive via the PROFIsafe fieldbus in combination with the VLT® PROFINET MCA 120 fieldbus option. Central and decentral drives located at different machinery cells can easily be interconnected with the PROFIsafe

safety fieldbus. This interconnection enables activation of Safe Torque Off (STO) irrespective of where a hazard occurs. The safety functions of the MCB 152 are implemented according to EN IEC 61800-5-2.

The MCB 152 supports PROFIsafe functionality to activate integrated safety functions of the VLT® AutomationDrive from any PROFIsafe host, up to Safety Integrity Level SIL 2 according to EN IEC 61508 and EN IEC 62061, Performance Level PL d, Category 3 according to EN ISO 13849-1.

Quick commissioning

Parameter configuration is fully integrated into the VLT® Motion Control Tool MCT 10 and enables simple start-up and easy maintenance. Visual instructions in MCT 10 ensure both fault-free wiring and that safety parameters are correctly transferred from the PC to the drive.

The software also offers easy diagnosis and a dynamic commissioning report which can be used for supplying certification documentation necessary for safety acceptance tests.

Before

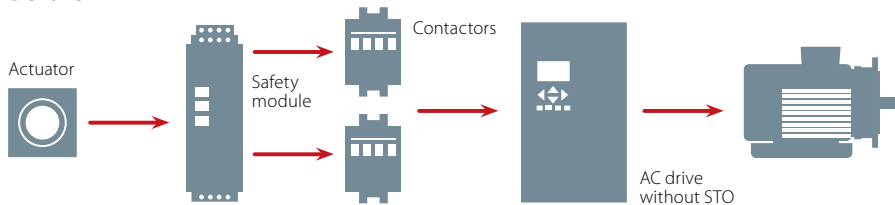

After

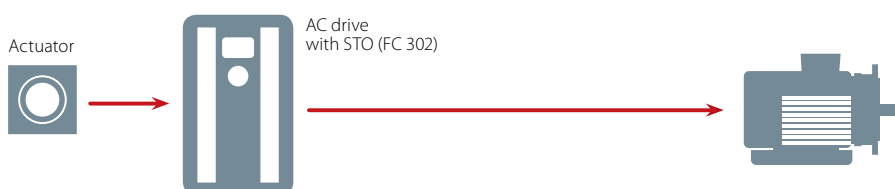

Free to connect

Real-time information is becoming increasingly important in industrial automation and control systems as we progress further into Industry 4.0. Immediate access to data increases transparency in production facilities, while making it possible to optimize system performance, collect and analyze system data and provide remote support around the clock from anywhere in the world.

Regardless of your application or your preferred communication protocol, AC drives have an extremely wide variety of communication protocols to select from. In this way you can ensure that the AC drive integrates seamlessly into your chosen system providing you the freedom to communicate however you see fit.

Increase productivity

Fieldbus communication reduces capital costs in production plants. In addition to the initial savings achieved through the significant reduction in wiring and control boxes, fieldbus

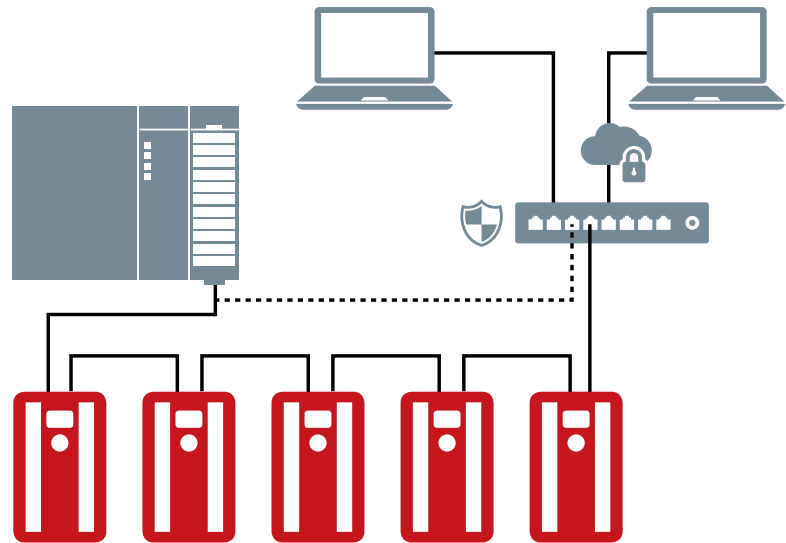

networks are easier to maintain, while providing improved systems performance.

User friendly and fast setup

Danfoss fieldbuses can be configured via the drive's local control panel, which features a user-friendly interface with support for many user languages.

The drive and fieldbus can also be configured using the software tools that support each drive family. Danfoss Drives offers fieldbus drivers and PLC examples for free from the Danfoss Drives website to make integration to your system even easier.



Web server dashboard

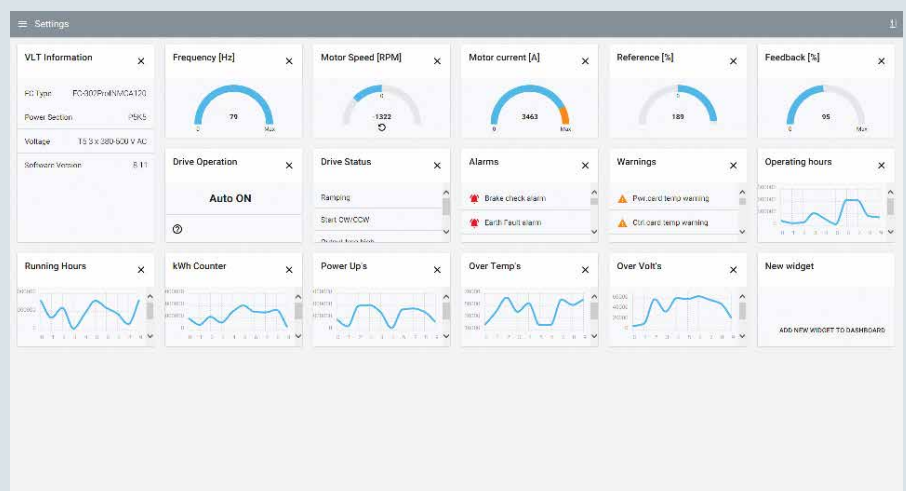

Customized commissioning experience

The VLT® Motion Control Tool MCT 10 is an interactive tool for quick and easy online/offline configuration of a VLT® drive or soft starter using a PC. You can also use the tool to configure the communication network and to back up all your relevant parameter settings. With MCT 10, you can control and configure your system simultaneously and monitor your entire system more effectively for faster monitoring, diagnosis, troubleshooting (alarms/warnings) and better preventive maintenance. Starting with version 4.00, MCT 10 includes even more features that enhance usability.

Status plug-in

The readouts for various status and control words, relay inputs and outputs that are available over the fieldbus have been greatly improved. We have combined these signals into a single plug-in that shows you much more information. You'll be able to see right away if a certain relay or bit is on or off, and what exact command the drive has been configured with, saving you time.

VLT® Software Customizer

VLT® Software Customizer allows you to customize the commissioning experience to best fit your needs. It is a tool that enables you to simply and quickly create and test your desired setup using the simulator before uploading it to a real drive.

The VLT® Software Customizer consists of three main features:

- **SplashScreen** allows you to create a custom splash screen for when the drive starts up. You can use the built-in editor to create an image from blank or import an existing image from a library or from your computer and adapt it to the VLT®.
- **InitialValues** allows you to set a new default value for virtually any parameter.
- **SmartStart** allows you to create a custom start-up wizard to go through exactly the parameters you need.



Motor plug-in

The motor plug-in makes it easier to select the needed motor type and to parameterize the drive accordingly. Simply select the required motor type, and the corresponding parameters are listed together with a description guiding you on how to set the correct value. The motor types supported by the motor plug-in are:

- Asynchronous
- PM, non-salient SPM
- PM, salient IPM
- Synchronous Reluctance (SynRM)

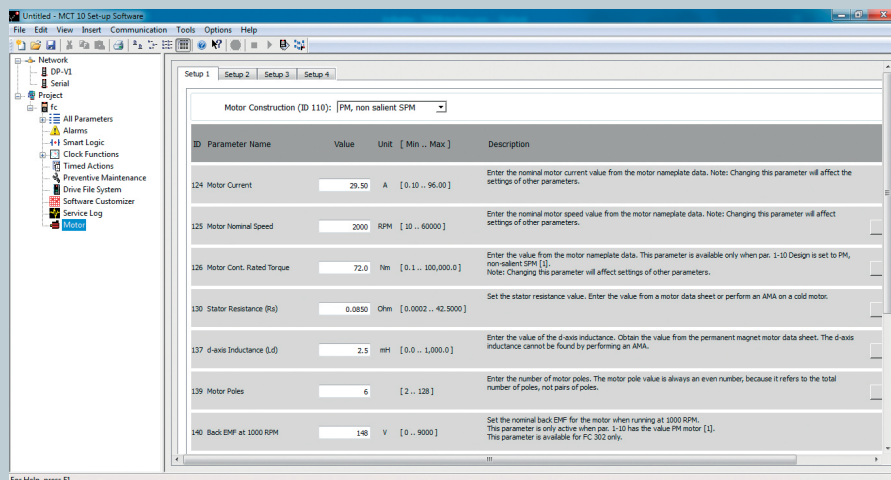

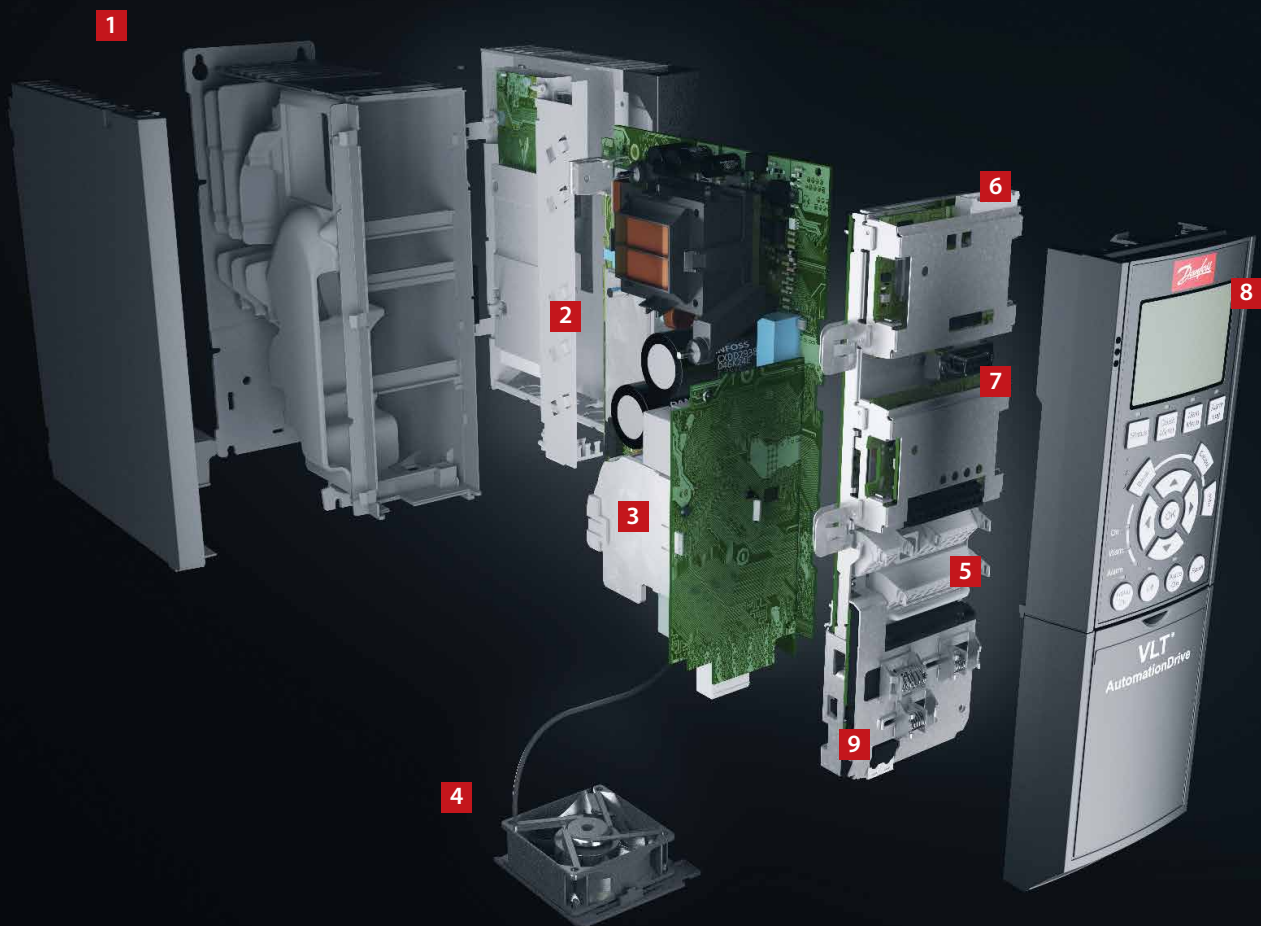

Modular simplicity – A, B and C enclosures

Delivered fully assembled and tested to meet your specific requirements

1. Enclosure

The drive meets requirements for enclosure class IP20/Chassis. IP21/UL Type 1, IP54/UL Type 12, IP55/UL Type 12 or IP66/UL Type 4X.

2. EMC and Network effects

All versions of VLT® AutomationDrive comply as standard with EMC limits B, A1 or A2 according to the EN 55011 norm and IEC61800-3 Category C1, C2 and C3. The standard integrated DC coils ensure low harmonic load on the network according to EN 61000-3-12 and increase the lifetime of the DC link capacitors.

3. Protective coating

The electronic components are, as standard, coated as per IEC 60721-3-3, class 3C2. For harsh and aggressive environments, coating as per IEC 60721-3-3, class 3C3 is available.

4. Removable fan

Like most of the elements, the fan can be quickly removed and remounted for easy cleaning.

5. Control terminals

Specially developed removable spring-loaded cage clamps add to reliability and facilitate easy commissioning and service.

6. Fieldbus option

All major industrial fieldbuses are supported. See complete list of available fieldbus options on page 41.

7. I/O options

The general purpose I/O, relay, safety and thermistor expands the flexibility of the drives.

8. Display option

Danfoss drives' renowned removable Local Control Panel (LCP) has an improved user interface. Choose between 28 built-in languages (including Chinese) or have it customized with your own. Languages can be changed by the user. Wireless version available.

Alternatively the drive can be commissioned via the built-in USB/RS485 connection or through fieldbus options with the VLT® Motion Control Tool MCT 10 PC tool.



9. 24 V supply or RTC

A 24 V supply option to keep the control section and any installed option functioning during power failure. An extended version combines a Real-time Clock with a battery in one D-option.

10. Mains switch

This switch interrupts the mains supply and has a free useable auxiliary contact.

Safety

Extended range of integrated functional safety. Please see chapter "Tailored safety" on page 17.

VLT® Wireless Communication Panel LCP 103

The VLT® Wireless Communication Panel LCP 103 (8) communicates with MyDrive® Connect – an app which can be downloaded to iOS- and Android-based smart devices.

MyDrive® Connect offers full access to the drive making it easier to perform commissioning, operation, monitoring and maintenance tasks. Utilizing the active point-to-point wireless connection, maintenance personnel can receive real-time error messages via the app to ensure a quick response to potential issues and reduce downtime.



High-power modularity – D, E and F enclosures

The high-power VLT® AutomationDrive modules are all built on a modular platform allowing for highly customized drives which are mass produced, tested, and delivered from the factory.

Upgrades and further options dedicated to your industry are a matter of plug-and-play. Once you know one, you know them all.

1. Display options

Danfoss drives' renowned removable Local Control Panel (LCP) has an improved user interface. Choose between 28 built-in languages (including Chinese) or have it customized with your own. Languages can be changed by the user.

2. Hot pluggable LCP

The LCP can be plugged in or unplugged during operation. Settings are easily transferred via the control panel from one drive to another or from a PC with MCT 10 set-up software.

3. Integrated manual

The info button makes the printed manual virtually redundant. Users have been involved throughout development to ensure optimum overall functionality of the drive. The user group has significantly influenced the design and functionality of the LCP.

The Automatic Motor Adaptation (AMA), the Quick Set-Up menu and the large graphic display make commissioning and operation a breeze.

4. Fieldbus options

See complete list of available fieldbus options on page 46.

5. I/O options

The general purpose I/O, relay and thermistor expands the flexibility of the drives.

6. Control terminals

Specially developed removable spring-loaded cage clamps add to reliability and facilitate easy commissioning and service.

7. 24 V supply

A 24 V supply keeps the VLT® drives logically "alive" in situations when the AC power supply is removed. Is available in an extended version with RTC. Real Time Clock parameters' settings will be supported.

8. RFI filter suitable for IT grids

All high-power drives come standard with RFI filtering according to EN 61800-3 Cat. C3/EN 55011 class A2. A1/C2 RFI filters according to IEC 61000 and EN 61800 standards as integrated options.

9. Modular construction and ease of maintenance

All components are easily accessible from the front of the drive, allowing for ease of maintenance and side-by-side mounting of drives. The drives are constructed using a modular design that allows for the easy replacement of modular sub-assemblies.

10. Programmable options

A freely programmable motion control option for user-specific control algorithms and programs allows the integration of PLC programs.

11. Conformally coated and ruggedized circuit boards

All high-power drive circuit boards are conformal coated to withstand the salt mist test. Meets IEC 60721-3-3 Class 3C3. The conformal coating complies with ISA (International Society of Automation) standard S71.04 1985, class G3. Additionally, drives in D and E enclosures can be further ruggedized to withstand the higher vibration needs of certain applications.

12. Back-channel cooling

The unique design uses a back channel to pass cooling air over heat sinks. This design allows up to 90% of the heat losses to be exhausted directly outside of the enclosure with minimal air passing through the electronics area. This reduces temperature rise and contamination of the electronic components for improved reliability and increased functional life.

As an option, the back-channel cooling duct can be supplied in stainless steel to provide a degree of corrosion resistance against conditions such as those found in salt-air environments near the ocean.

13. Enclosure

The drive meets relevant requirements for all possible installation conditions. Enclosure class IP00/chassis, IP20/chassis, IP21/UL Type 1, and IP54/UL Type 12. A kit is available to increase the enclosure class on enclosure size D drives to UL Type 3R.

14. DC-link reactor

The built-in DC-link reactor ensures low harmonic disturbance of the power supply in accordance with IEC-61000-3-12. The result is a more compact design with higher efficiencies than competitive systems with external-mounted AC chokes.

15. Input mains option

Various input configurations are available, including fuses, mains disconnect switch, or RFI filter.



Efficiency is vital for high-power drives

Efficiency is essential in the design of the high-power VLT® drive series. Innovative design and exceptionally high-quality components have resulted in unsurpassed energy efficiency.

VLT® drives pass more than 98% of the supplied electrical energy on to the motor. Only 2% or less is left in the power electronics as heat to be removed.

Energy is saved and electronics last longer because they are not exposed to high temperatures within the enclosure.

Safety

Extended range of integrated functional safety. Please see chapter "Tailored safety" on page 17.



Engineered for **cost savings** via **intelligent heat management**, compactness and **protection**

All Danfoss VLT® drives follow the same design principle for fast, flexible and fault-free installation, and efficient cooling.

The AC drives are available in a broad range of enclosure sizes and protection ratings from IP20 to IP66 to enable easy installation in all environments: mounted in panels, switch rooms or as stand-alone units in the production area.

Cost-saving heat management

In AC drives, there is total separation between the back-channel cooling air and the internal electronics. This separation greatly reduces the airflow over the sensitive electronics, minimizing the exposure to

contaminants. At the same time, it removes heat efficiently which helps to prolong product life, increase the overall availability of the system and reduce faults related to high temperatures.

For example, by exhausting heat directly outside, it is possible to reduce the size of the cooling system in the panel or switch room. This can be achieved with Danfoss' extremely efficient back-channel cooling concept, allowing heat to be vented outside the control room.

In daily use, the benefits are equally clear as the energy consumption related to cooling can be reduced significantly. This means that designers can reduce the size of the air conditioning system, or even eliminate it entirely.

Coated circuit boards

The AC drive conforms as standard to class 3C3 (IEC 60721-3-3) to ensure long lifetime even in harsh environments.

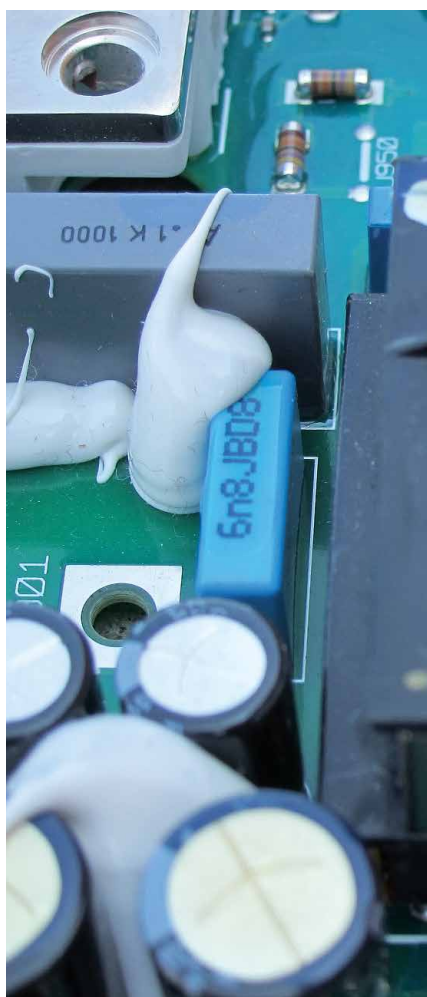

Ruggedized for extra **protection**

In order to reduce the potential negative effects of vibration, the drives have been 'ruggedized'. It is a process that ensures that critical components on the PCB have increased protection, significantly reducing the risk of malfunction while at sea.

The printed circuit boards in the drives are also all coated in accordance with IEC 60721-3-3 class 3C3, providing additional protection against moisture and dust.

Reliable operation at engine room temperatures up to 55 °C

VLT® drives can operate at full load in engine rooms with 50°C temperature and 55 °C at reduced power close to, for example, pumps and thrusters. There is no need for installation in air-conditioned control rooms with long motor cables.

Spark-free design

The VLT® drives conform to the Limited Explosion Risk requirements in The European Agreement concerning the International Carriage of Dangerous Goods by Inland Waterways, as they do not create any sparks during normal operation and the temperature does not exceed 200°C.

Back-channel cooling gives up to **90%** reduction in investment for air cooling systems

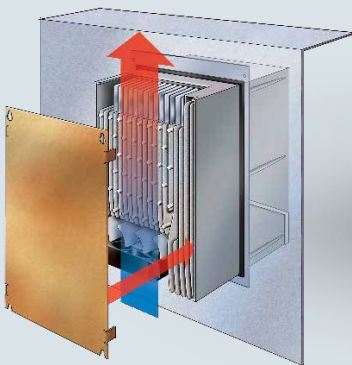

Panel-through cooling

An accessory mounting kit for small and mid-range drives enables heat losses to be directed directly outside the panel room.

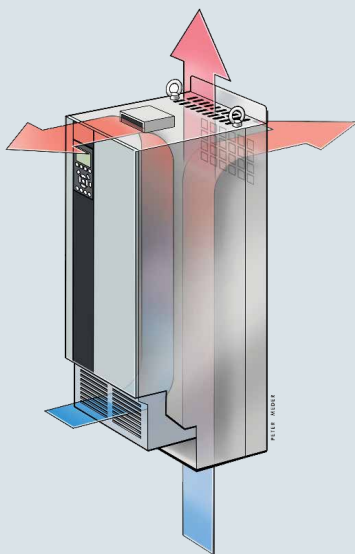

Minimal airflow over electronics

Complete separation between back-channel cooling air and the internal electronics ensures efficient cooling.



Back-channel cooling

By directing air through a rear cooling channel, up to 90% of the drive's heat loss is removed directly outside the installation room.

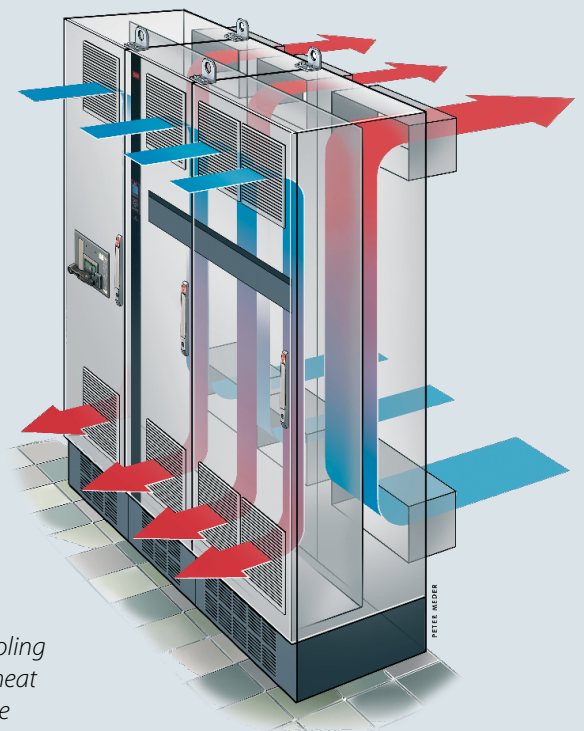

Optimize performance and grid protection

Built-in protection

The AC drive contains all the modules necessary for compliance with EMC standards.

A built-in, scalable RFI filter minimizes electromagnetic interference, and the integrated DC link chokes reduce the harmonic distortion in the mains network, in accordance with IEC 61000-3-12. Furthermore, they increase the lifetime of the DC link capacitors and therefore the overall efficiency of the drive.

These built-in components save cabinet space, as they are integrated in the drive from the factory. Efficient EMC mitigation also enables the use of cables with smaller cross-sections, which reduces installation costs.

Expand grid and motor protection with filter solutions

Danfoss' wide range of solutions for harmonic mitigation ensures a clean power supply and optimal equipment protection, and includes:

- VLT® Advanced Harmonic Filter AHF
- VLT® Advanced Active Filter AAF
- VLT® Low Harmonic Drives
- VLT® 12-pulse Drives

Provide extra motor protection with:

- VLT® Sine-wave Filter
- VLT® dU/dt Filter
- VLT® Common Mode Filters

Achieve optimum performance for your application, even where the grid is weak or unstable.

Use motor cables up to 300 m

The design of the AC drive makes it a perfect choice in applications that require long motor cables. Without needing additional components, the drive provides trouble-free operation with cable lengths of up to 150 m shielded or 300 m unshielded. This allows the drive to be installed in a central control room, away from the application without affecting motor performance.

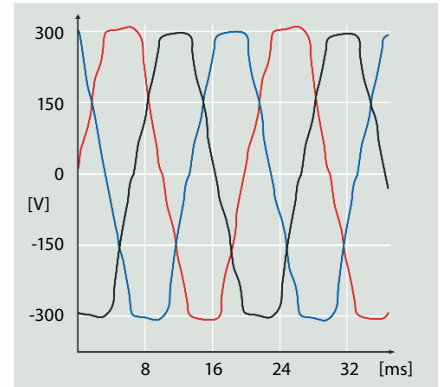

Harmonic distortion

Electrical interference reduces efficiency and risks harming equipment.

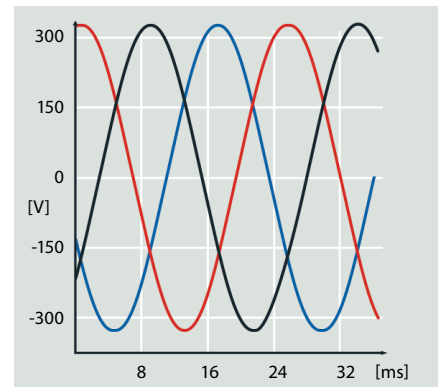

Optimized harmonic performance

Efficient harmonic mitigation protects electronics and increases efficiency.

EMC Standards		Conducted emission		
Standards and requirements	EN 55011 <i>Facility operators must comply with EN 55011</i>	Class B Housing and light industries	Class A Group 1 Industrial environment	Class A Group 2 Industrial environment
	EN/IEC 61800-3 <i>Converter manufacturers must conform to EN 61800-3</i>	Category C1 First environment, home and office	Category C2 First environment, home and office	Category C3 Second environment
Compliance ¹⁾		■	■	■

¹⁾ Compliance to mentioned EMC classes depends on the selected filter. For further details see the design guides.

You're covered with DrivePro® Life Cycle service products

Get the most out of your systems, with the help of DrivePro® services for Danfoss VLT® and VACON® drives. You get services that go beyond simple troubleshooting, maintenance, repairs and replacements. They also proactively improve productivity, performance and uptime.

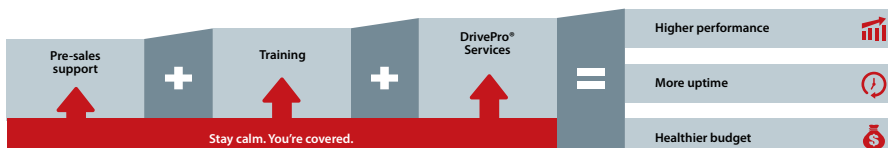
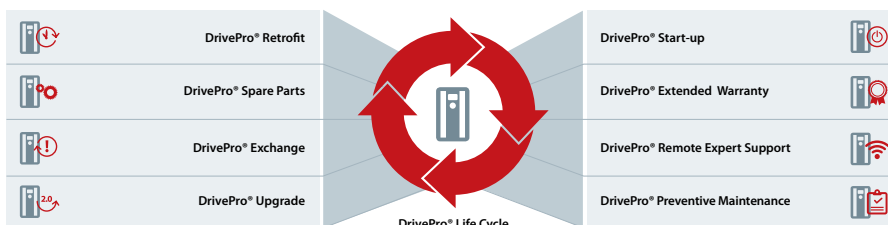

DrivePro® app

Use the DrivePro app for fast access to the DrivePro® services, for improved productivity, performance and uptime of your systems. Find your closest service partner, place a service request, and register your VLT® and VACON® drives. You can also look up product information, specifications and manuals for your specific VLT® or VACON® drive based on the nameplate product code, or the product name.



Discover more at drivepro.danfoss.com

Connection example

The numbers represent the terminals on the drive

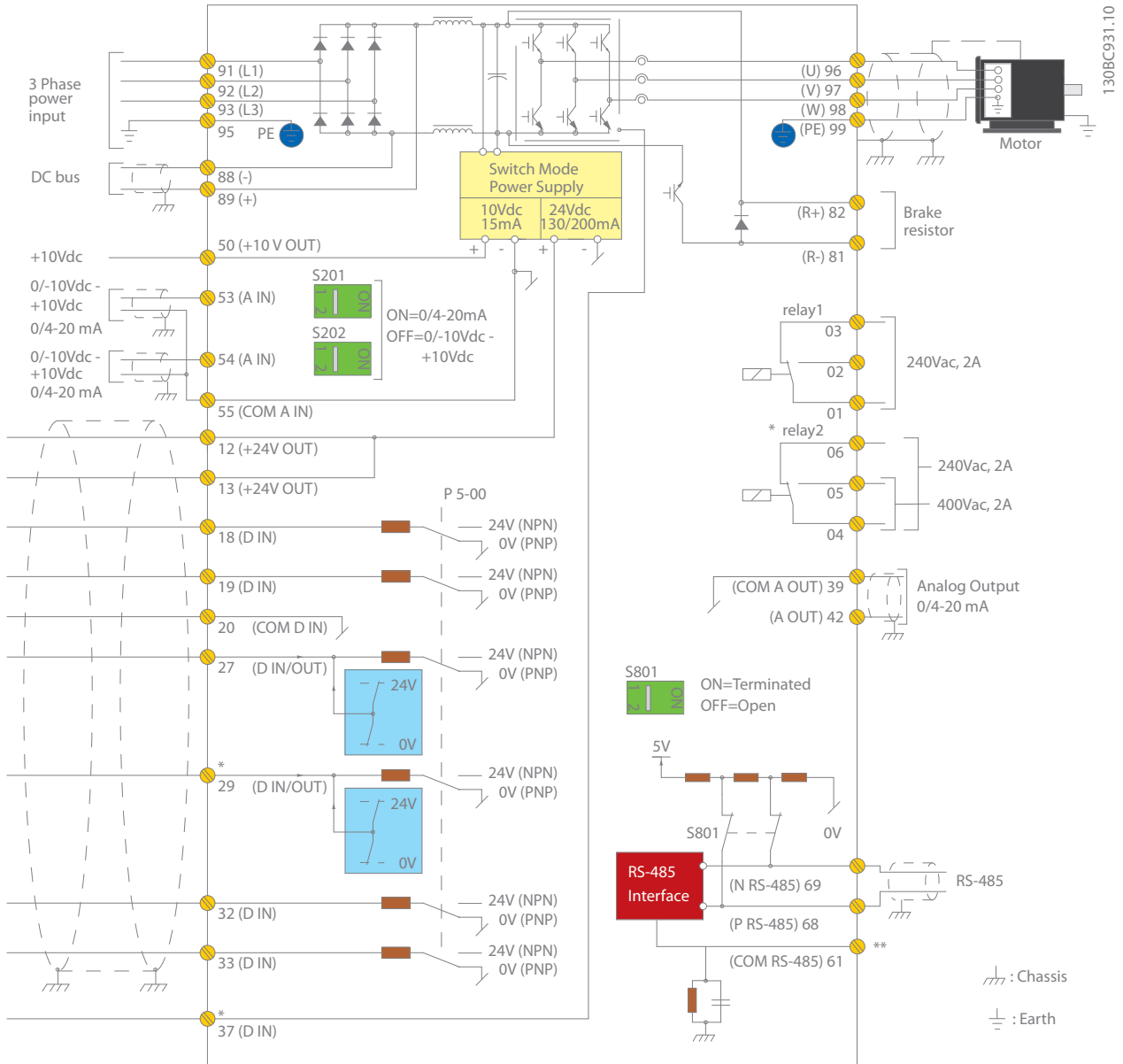

This diagram shows a typical installation of the VLT® AutomationDrive. Power is connected to the terminals 91 (L1), 92 (L2) and 93 (L3) and the motor is connected to 96 (U), 97 (V) and 98 (W).

Terminals 88 and 89 are used for load sharing between drives. Analog inputs can be connected to the 53 (V or mA), and for 54 (V or mA) terminals.

These inputs can be set up as either reference, feedback or thermistor inputs.

There are 6 digital inputs to be connected to terminals 18, 19, 27, 29, 32, and 33. Two digital input/output terminals (27 and 29) can be set up as digital outputs to show an actual status or warning or can be used as a pulse reference signal. The terminal 42 analog output can show process values such as 0 - I_{max}.

On the 68 (P+) and 69 (N-) terminals' RS 485 interface, the drive can be controlled and monitored via serial communication.

Technical data

Basic unit without extensions

Main supply (L1, L2, L3)	
Supply voltage	200-240 V AC 380-500 V AC 525-600 V AC 525-690 V AC
Supply frequency	50/60 Hz
Displacement power factor (cos φ) near unity	> 0.98
Switching on input supply L1, L2, L3	1-2 times/min.
Output data (T1, T2, T3)	
Output voltage	0-100% of supply voltage
Output frequency	0-590 Hz
Switching on output	Unlimited
Ramp times	0.01-3600 s
Digital inputs	
Programmable digital inputs	6*
Changeable to digital output	2 (terminal 27, 29)
Logic	PNP or NPN
Voltage level	0-24 V DC
Maximum voltage on input	28 V DC
Input resistance, Ri	Approx. 4 kΩ
Scan interval	5 ms

* Two of the inputs can be used as digital outputs

Analog inputs	
Analog inputs	2
Modes	Voltage or current
Voltage level	0 to +10 V (scaleable)
Current level	0/4 to 20 mA (scaleable)
Accuracy of analog inputs	Max. error: 0.5% of full scale
Pulse inputs	
Programmable pulse inputs	2*
Voltage level	0-24 V DC (PNP positive logic)
Pulse input accuracy (0.1-1 kHz)	Max. error: 0.1% of full scale

* Two of the digital inputs can be used for pulse inputs.

Digital outputs	
Programmable digital/pulse outputs	2
Voltage level at digital/frequency output	0-24 V DC
Max. output current (sink or source)	40 mA
Maximum output frequency	0-32 kHz
Accuracy on frequency output	Max. error: 0.1% of full scale
Analog outputs	
Programmable analog outputs	1
Current range at analog output	0/4-20 mA
Max. load to common at analog output (clamp 30)	500 Ω
Accuracy on analog output	Max. error: 0.5% of full scale

Control card	
USB interface	1.1 (Full Speed)
USB plug	Type "B"
RS485 interface	Up to 115 kBaud
Max. load (10 V)	15 mA
Max. load (24 V)	200 mA

Relay outputs	
Programmable relay outputs	2
Max. terminal load (AC) on 1-3 (NC), 1-2 (NO), 4-6 (NC) power card	240 V AC, 2 A
Max. terminal load (AC -1) on 4-5 (NO) power card	400 V AC, 2 A
Min. terminal load on 1-3 (NC), 1-2 (NO), 4-6 (NC), 4-5 (NO) power card	24 V DC 10 mA, 24 V AC 20 mA

Surroundings/external	
Ingress protection class	IP: 00/20/21/54/55/66 UL Type: Chassis/1/12/3R/4X
Vibration test	0.7 g
Max. relative humidity	5-95% (IEC 721-3-3); Class 3K3 (non-condensing) during operation
Ambient temperature	Max. 50 °C without derating
Galvanic isolation of all	I/O supplies according to PELV
Aggressive environment	Designed for 3C3 (IEC 60721-3-3)

Ambient temperature	
– Operating temperature range is -25 °C to 50 °C without derating Max 55 °C with derating	

Fieldbus communication	
Standard built-in: FC Protocol N2 Metasys FLN Apogee Modbus RTU	Optional: VLT® PROFIBUS DP V1 MCA 101 VLT® DeviceNet MCA 104 VLT® CANopen MCA 105 VLT® 3000 PROFIBUS Converter MCA 113 VLT® 5000 PROFIBUS Converter MCA 114 VLT® PROFINET MCA 120 VLT® EtherNet/IP MCA 121 VLT® Modbus TCP MCA 122 VLT® POWERLINK MCA 123 VLT® EtherCAT MCA 124 VLT® 5000 DeviceNet Converter MCA 194

Protection mode for longest possible up-time	
– Electronic motor thermal protection against overload	
– Protection against overtemperature	
– The AC drive is protected against short circuits on motor terminals R, S, T	
– The AC drive is protected against ground faults on motor terminals U, V, W	
– Protection against mains phase loss	
– Real-Time Clock with battery backup	
– Advanced data logging using real-time stamps	
– Predictive maintenance	
– Preventive maintenance	
– D-option VLT® Real-time Clock Option MCB 117	

Agency approvals



Electrical data – A, B, and C enclosures

[T2] 3 x 200-240 V AC – high overload

High overload (160% 1 min/10 min)							Enclosure size			
Type code	Output current (3 x 200-240 V)		Typical shaft output power		Continuous input current	Estimated power loss	Protection rating [IEC/UL]			
	Con. I _N	Inter. I _{MAX} (60 s)	kW @ 208 V	Hp @ 230 V			IP20/21	IP21	IP55	IP66
FC-302	Con. I _N	Inter. I _{MAX} (60 s)	kW @ 208 V	Hp @ 230 V	[A]	[W]	Chassis	Type 1	Type 12	Type 4X
PK25	1.8	2.9	0.25	0.34	2.6	21	A1*/A2	A2	A4/A5	A4/A5
PK37	2.4	3.8	0.37	0.5	3.5	29	A1*/A2	A2	A4/A5	A4/A5
PK55	3.5	5.6	0.55	0.75	5.1	42	A1*/A2	A2	A4/A5	A4/A5
PK75	4.6	7.4	0.75	1	6.6	54	A1*/A2	A2	A4/A5	A4/A5
P1K1	6.6	10.6	1.1	1.5	9.4	63	A1*/A2	A2	A4/A5	A4/A5
P1K5	7.5	12	1.5	2	10.9	82	A1*/A2	A2	A4/A5	A4/A5
P2K2	10.6	17	2.2	3	15.2	116	A2	A2	A4/A5	A4/A5
P3K0	12.5	20	3	4	18.1	155	A3	A3	A5	A5
P3K7	16.7	26.7	3.7	5	24	185	A3	A3	A5	A5
P5K5	24.2	38.7	5.5	7.5	35.2	239	B3	B1	B1	B1
P7K5	30.8	49.3	7.5	10	44.8	371	B3	B1	B1	B1
P11K	46.2	73.9	11	15	67.2	463	B4	B2	B2	B2
P15K	59.4	89.1	15	20	81	624	B4	C1	C1	C1
P18K	74.8	112	18.5	25	102	740	C3	C1	C1	C1
P22K	88	132	22	30	120	874	C3	C1	C1	C1
P30K	115	173	30	40	156	1143	C4	C2	C2	C2
P37K	143	215	37	50	195	1400	C4	C2	C2	C2

*A1 enclosure is only available as FC 301

[T2] 3 x 200-240 V AC – normal overload

Normal overload (110% 1 min/10 min)							Enclosure size			
Type code	Output current (3 x 200-240 V)		Typical shaft output power		Continuous input current	Estimated power loss	Protection rating [IEC/UL]			
	Con. I _N	Inter. I _{MAX} (60 s)	kW @ 208 V	Hp @ 230 V			IP20/21	IP21	IP55	IP66
FC-302	Con. I _N	Inter. I _{MAX} (60 s)	kW @ 208 V	Hp @ 230 V	[A]	[W]	Chassis	Type 1	Type 12	Type 4X
PK25	1.8	2.9	0.25	0.34	2.6	21	A1*/A2	A2	A4/A5	A4/A5
PK37	2.4	3.8	0.37	0.5	3.5	29	A1*/A2	A2	A4/A5	A4/A5
PK55	3.5	5.6	0.55	0.75	5.1	42	A1*/A2	A2	A4/A5	A4/A5
PK75	4.6	7.4	0.75	1	6.6	54	A1*/A2	A2	A4/A5	A4/A5
P1K1	6.6	10.6	1.1	1.5	9.4	63	A1*/A2	A2	A4/A5	A4/A5
P1K5	7.5	12	1.5	2	10.9	82	A1*/A2	A2	A4/A5	A4/A5
P2K2	10.6	17	2.2	3	15.2	116	A2	A2	A4/A5	A4/A5
P3K0	12.5	20	3	4	18.1	155	A3	A3	A5	A5
P3K7	16.7	26.7	3.7	5	24	185	A3	A3	A5	A5
P5K5	30.8	33.9	7.5	10	30.8	310	B3	B1	B1	B1
P7K5	46.2	50.8	11	15	46.2	514	B3	B1	B1	B1
P11K	59.4	65.3	15	20	59.4	602	B4	B2	B2	B2
P15K	74.8	82.3	18.5	25	74.8	737	B4	C1	C1	C1
P18K	88	96.8	22	30	88	845	C3	C1	C1	C1
P22K	115	127	30	40	114	1140	C3	C1	C1	C1
P30K	143	157	37	50	143	1353	C4	C2	C2	C2
P37K	170	187	45	60	169	1636	C4	C2	C2	C2

*A1 enclosure is only available as FC 301

[T5] 3 x 380-500 V AC – high overload

Type code	High overload (160% 1 min/10 min)							Enclosure size				
	Output current				Typical shaft output power		Continuous input current	Estimated power loss	Protection rating [IEC/UL]			
	(3 x 380-440 V)		(3 x 441-500 V)						IP20/21	IP21	IP55	IP66
FC-302	Con. I _N	Inter. I _{MAX} (60 s)	Con. I _N	Inter. I _{MAX} (60 s)	kW @ 400 V	Hp @ 460 V	[A]	[W]	Chassis	Type 1	Type 12	Type 4X
PK37	1.3	2.1	1.2	1.9	0.37	0.5	1.9	35	A1*/A2	A2	A4/A5	A4/A5
PK55	1.8	2.9	1.6	2.6	0.55	0.75	2.6	42	A1*/A2	A2	A4/A5	A4/A5
PK75	2.4	3.8	2.1	3.4	0.75	1	3.5	46	A1*/A2	A2	A4/A5	A4/A5
P1K1	3	4.8	2.7	4.3	1.1	1.5	4.3	58	A1*/A2	A2	A4/A5	A4/A5
P1K5	4.1	6.6	3.4	5.4	1.5	2	5.9	62	A1*/A2	A2	A4/A5	A4/A5
P2K2	5.6	9	4.8	7.7	2.2	3	8	88	A2	A2	A4/A5	A4/A5
P3K0	7.2	11.5	6.3	10.1	3	4	10.4	116	A2	A2	A4/A5	A4/A5
P4K0	10	16	8.2	13.1	4	5	14.4	124	A2	A2	A4/A5	A4/A5
P5K5	13	20.8	11	17.6	5.5	7.5	18.7	187	A3	A3	A5	A5
P7K5	16	25.6	14.5	23.2	7.5	10	23	255	A3	A3	A5	A5
P11K	24	38.4	21	33.6	11	15	35.2	291	B3	B1	B1	B1
P15K	32	51.2	27	43.2	15	20	46.4	379	B3	B1	B1	B1
P18K	37.5	60	34	54.4	18.5	25	54.4	444	B4	B2	B2	B2
P22K	44	70.4	40	64	22	30	64	547	B4	B2	B2	B2
P30K	61	91.5	52	78	30	40	82.5	570	B4	C1	C1	C1
P37K	73	110	65	97.5	37	50	99	697	C3	C1	C1	C1
P45K	90	135	80	120	45	60	123	891	C3	C1	C1	C1
P55K	106	159	105	158	55	75	144	1022	C4	C2	C2	C2
P75K	147	221	130	195	75	100	200	1232	C4	C2	C2	C2

*A1 enclosure is only available as FC 301

[T5] 3 x 380-500 V AC – normal overload

Type code	Normal overload (110% 1 min/10 min)							Enclosure size				
	Output current				Typical shaft output power		Continuous input current	Estimated power loss	Protection rating [IEC/UL]			
	(3 x 380-440 V)		(3 x 441-500 V)						IP20/21	IP21	IP55	IP66
FC-302	Con. I _N	Inter. I _{MAX} (60 s)	Con. I _N	Inter. I _{MAX} (60 s)	kW @ 400 V	Hp @ 460 V	[A]	[W]	Chassis	Type 1	Type 12	Type 4X
PK37	1.3	2.1	1.2	1.9	0.37	0.5	1.9	35	A1*/A2	A2	A4/A5	A4/A5
PK55	1.8	2.9	1.6	2.6	0.55	0.75	2.6	42	A1*/A2	A2	A4/A5	A4/A5
PK75	2.4	3.8	2.1	3.4	0.75	1	3.5	46	A1*/A2	A2	A4/A5	A4/A5
P1K1	3	4.8	2.7	4.3	1.1	1.5	4.3	58	A1*/A2	A2	A4/A5	A4/A5
P1K5	4.1	6.6	3.4	5.4	1.5	2	5.9	62	A1*/A2	A2	A4/A5	A4/A5
P2K2	5.6	9	4.8	7.7	2.2	3	8	88	A2	A2	A4/A5	A4/A5
P3K0	7.2	11.5	6.3	10.1	3	4	10.4	116	A2	A2	A4/A5	A4/A5
P4K0	10	16	8.2	13.1	4	5	14.4	124	A2	A2	A4/A5	A4/A5
P5K5	13	20.8	11	17.6	5.5	7.5	18.7	187	A3	A3	A5	A5
P7K5	16	25.6	14.5	23.2	7.5	10	23	255	A3	A3	A5	A5
P11K	32	35.2	27	29.7	15	20	31.9	392	B3	B1	B1	B1
P15K	37.5	41.3	34	37.4	18.5	25	37.4	465	B3	B1	B1	B1
P18K	44	48.4	40	44	22	30	44	525	B4	B2	B2	B2
P22K	61	67.1	52	57.2	30	40	60.5	739	B4	B2	B2	B2
P30K	73	80.3	65	71.5	37	50	72.6	698	B4	C1	C1	C1
P37K	90	99	80	88	45	60	90.2	843	C3	C1	C1	C1
P45K	106	117	105	116	55	75	106	1083	C3	C1	C1	C1
P55K	147	162	130	143	75	100	146	1384	C4	C2	C2	C2
P75K	177	195	160	176	90	125	177	1474	C4	C2	C2	C2

*A1 enclosure is only available as FC 301

[T6] 3 x 525-600 V AC – high overload

High overload (160% 1 min/10 min)							Enclosure size			
Type code	Output current (3 x 525-600 V)		Typical shaft output power		Intermittent input current	Estimated power loss	Protection rating [IEC/UL]			
	Con. I _N	Inter. I _{MAX} (60 s)	kW @ 575 V	Hp @ 575 V			IP20	IP21	IP55	IP66
FC-302	Con. I _N	Inter. I _{MAX} (60 s)	kW @ 575 V	Hp @ 575 V	[A]	[W]	Chassis	Type 1	Type 12	Type 4X
PK75	1.7	2.7	0.75	1	2.7	35	A3	A3	A5	A5
P1K1	2.4	3.8	1.1	1.5	3.8	50	A3	A3	A5	A5
P1K5	2.7	4.3	1.5	2	4.3	65	A3	A3	A5	A5
P2K2	3.9	6.2	2.2	3	6.6	92	A3	A3	A5	A5
P3K0	4.9	7.8	3	4	8.3	122	A3	A3	A5	A5
P4K0	6.1	9.8	4	5	9.3	145	A3	A3	A5	A5
P5K5	9	14.4	5.5	7.5	13.8	195	A3	A3	A5	A5
P7K5	11	17.6	7.5	10	16.6	261	A3	A3	A5	A5
P11K	18	29	11	15	28	220	B3	B1	B1	B1
P15K	22	35	15	20	33	300	B3	B1	B1	B1
P18K	27	43	18.5	25	41	370	B4	B2	B2	B2
P22K	34	54	22	30	52	440	B4	B2	B2	B2
P30K	41	62	30	40	59	600	B4	C1	C1	C1
P37K	52	78	37	50	70	740	C3	C1	C1	C1
P45K	62	93	45	60	85	900	C3	C1	C1	C1
P55K	83	125	55	75	113	1100	C4	C2	C2	C2
P75K	100	150	75	100	137	1500	C4	C2	C2	C2

[T6] 3 x 525-600 V AC – normal overload

Normal overload (110% 1 min/10 min)							Enclosure size			
Type code	Output current (3 x 525-600 V)		Typical shaft output power		Intermittent input current	Estimated power loss	Protection rating [IEC/UL]			
	Con. I _N	Inter. I _{MAX} (60 s)	kW @ 575 V	Hp @ 575 V			IP20	IP21	IP55	IP66
FC-302	Con. I _N	Inter. I _{MAX} (60 s)	kW @ 575 V	Hp @ 575 V	[A]	[W]	Chassis	Type 1	Type 12	Type 4X
PK75	1.7	2.7	0.75	1	2.7	35	A3	A3	A5	A5
P1K1	2.4	3.8	1.1	1.5	3.8	50	A3	A3	A5	A5
P1K5	2.7	4.3	1.5	2	4.3	65	A3	A3	A5	A5
P2K2	3.9	6.2	2.2	3	6.6	92	A3	A3	A5	A5
P3K0	4.9	7.8	3	4	8.3	122	A3	A3	A5	A5
P4K0	6.1	9.8	4	5	9.3	145	A3	A3	A5	A5
P5K5	9	14.4	5.5	7.5	13.8	195	A3	A3	A5	A5
P7K5	11	17.6	7.5	10	16.6	261	A3	A3	A5	A5
P11K	22	24	15	20	23	300	B3	B1	B1	B1
P15K	27	30	18.5	25	28	370	B3	B1	B1	B1
P18K	34	37	22	30	36	440	B4	B2	B2	B2
P22K	41	45	30	40	43	600	B4	B2	B2	B2
P30K	52	57	37	50	54	740	B4	C1	C1	C1
P37K	62	68	45	60	62	900	C3	C1	C1	C1
P45K	83	91	55	74	83	1100	C3	C1	C1	C1
P55K	100	110	75	100	100	1500	C4	C2	C2	C2
P75K	131	144	90	120	131	1800	C4	C2	C2	C2

[T7] 3 x 525-690 V AC – high overload

Type code	High overload (160% 1 min/10 min)						Enclosure size				
	Output current				Typical shaft output power		Continuous input current	Estimated power loss	Protection rating [IEC]		
	(3 x 525-550 V)		(3 x 551-690 V)						IP20	IP21	IP55
FC-302	Con. I _N	Inter. I _{MAX} (60 s)	Con. I _N	Inter. I _{MAX} (60 s)	kW @ 690 V	Hp @ 575 V	[A]	[W]	*	*	*
P1K1	2.1	3.4	1.6	2.6	1.1	1.5	3	44	A3	A3	A5
P1K5	2.7	4.3	2.2	3.5	1.5	2	3.9	60	A3	A3	A5
P2K2	3.9	6.2	3.2	5.1	2.2	3	5.6	88	A3	A3	A5
P3K0	4.9	7.8	4.5	7.2	3	4	7	120	A3	A3	A5
P4K0	6.1	9.8	5.5	8.8	4	5	8.8	160	A3	A3	A5
P5K5	9	14.4	7.5	12	5.5	7.5	12.9	220	A3	A3	A5
P7K5	11	17.6	10	16	7.5	10	15.8	300	A3	A3	A5
P11K	14	22.4	13	20.8	11	10	23.2	150	B4	B2	B2
P15K	19	30.4	18	28.8	15	15	31.2	220	B4	B2	B2
P18K	23	36.8	22	35.2	18.5	20	38.4	300	B4	B2	B2
P22K	28	44.8	27	43.2	22	25	46.4	370	B4	B2	B2
P30K	36	54	34	51	30	30	54	600	B4	C2	C2
P37K	43	64.5	41	61.5	37	40	72	740	C3	C2	C2
P45K	54	81	52	78	45	50	87	900	C3	C2	C2
P55K	65	97.5	62	93	55	60	105	1100	–	C2	C2
P75K	87	130.5	83	124.5	75	75	129	1500	–	C2	C2

*Note: T7 drives are not UL certified. Select T6 for UL certification.

[T7] 3 x 525-690 V AC – normal overload

Type code	Normal overload (110% 1 min/10 min)						Enclosure size				
	Output current				Typical shaft output power		Continuous input current	Estimated power loss	Protection rating [IEC]		
	(3 x 525-550 V)		(3 x 551-690 V)						IP20	IP21	IP55
FC-302	Con. I _N	Inter. I _{MAX} (60 s)	Con. I _N	Inter. I _{MAX} (60 s)	kW @ 690 V	Hp @ 575 V	[A]	[W]	*	*	*
P1K1	2.1	3.4	1.6	2.6	1.1	1.5	3	44	A3	A3	A5
P1K5	2.7	4.3	2.2	3.5	1.5	2	3.9	60	A3	A3	A5
P2K2	3.9	6.2	3.2	5.1	2.2	3	5.6	88	A3	A3	A5
P3K0	4.9	7.8	4.5	7.2	3	4	7	120	A3	A3	A5
P4K0	6.1	9.8	5.5	8.8	4	5	8.8	160	A3	A3	A5
P5K5	9	14.4	7.5	12	5.5	7.5	12.9	220	A3	A3	A5
P7K5	11	17.6	10	16	7.5	10	15.8	300	A3	A3	A5
P11K	19	20.9	18	19.8	15	15	21.5	220	B4	B2	B2
P15K	23	25.3	22	24.2	18.5	20	26.4	300	B4	B2	B2
P18K	28	30.8	27	29.7	22	25	31.9	370	B4	B2	B2
P22K	36	39.6	34	37.4	30	30	39.6	440	B4	B2	B2
P30K	43	47.3	41	45.1	37	40	53.9	740	B4	C2	C2
P37K	54	59.4	52	57.2	45	50	64.9	900	C3	C2	C2
P45K	65	71.5	62	68.2	55	60	78.1	1100	C3	C2	C2
P55K	87	95.7	83	91.3	75	75	95.7	1500	–	C2	C2
P75K	105	115.5	100	110	90	100	108.9	1800	–	C2	C2

*Note: T7 drives are not UL certified. Select T6 for UL certification.

Dimensions enclosure sizes A, B and C

Enclosure size		VLT® AutomationDrive														
		A1	A2		A3		A4	A5	B1	B2	B3	B4	C1	C2	C3	C4
Protection rating [IEC/UL]		IP20 Chassis	IP20 Chassis	IP21 Type 1	IP20 Chassis	IP21 Type 1	IP55/Type 12 IP66/Type 4X		IP21/Type 1 IP55/Type 12 IP66/Type 4X		IP00/Chassis		IP21/Type 1 IP55/Type 12 IP66/Type 4X		IP00/Chassis	
[mm]	Height	200	268	375	268	375	390	420	480	650	399	520	680	770	550	660
	Height with decoupling plate	316	374	–	374	–	–	–	–	–	420	595	–	–	630	800
	Width	75	90	90	130	130	200	242	242	242	165	230	308	370	308	370
	Width with one C option	–	130	130	170	170	–	242	242	242	205	230	308	370	308	370
	Width with two C options	–	150	150	190	190	–	242	242	242	225	230	308	370	308	370
	Depth	207	205	207	205	207	175	200	260	260	249	242	310	335	333	333
	Depth with A, B option	222	220	222	220	222	175	200	260	260	262	242	310	335	333	333
	Depth with mains disconnect	–	–	–	–	–	206	224	289	290	–	–	344	378	–	–
[kg]	Weight	2.7	4.9	5.3	6	7	9.7	14.2	23	27	12	23.5	45	64	35	50
[in]	Height		10.6	14.8	10.6	14.8	15.4	16.6	18.9	25.6	15.8	20.5	26.8	30.4	21.7	26
	Height with decoupling plate		14.8	–	14.8	–	–	–	–	–	16.6	23.5	–	–	24.8	31.5
	Width		3.6	3.6	5.2	5.2	7.9	9.6	9.6	9.6	6.5	9.1	12.2	14.6	12.2	14.6
	Width with one C option		5.2	5.2	6.7	6.7	–	9.6	9.6	9.6	8.1	9.1	12.2	14.6	12.2	14.6
	Width with two C options		6	6	7.5	7.5	–	9.6	9.6	9.6	8.9	9.1	12.2	14.6	12.2	14.6
	Depth		8.1	18.2	8.1	8.2	6.9	7.9	10.3	10.3	9.8	9.6	12.3	13.2	13	13
	Depth with mains disconnect		–	–	–	–	8.2	8.9	11.4	11.5	–	–	13.6	14.9	–	–
	Depth with A, B option		8.7	8.8	8.7	8.8	6.9	7.9	10.3	10.3	10.4	9.6	12.3	13.2	13	13
[lb]	Weight		10.8	11.7	14.6	15.5	21.5	31.5	50.7	59.6	26.5	52	99.3	143.3	77.2	110.2

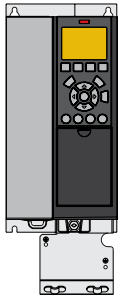

A3 IP20/Chassis with decoupling plate

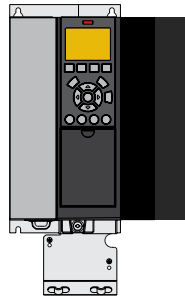

A3 IP20 with option C

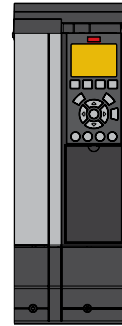

A3 with IP21/Type 12 NEMA 1 Kit

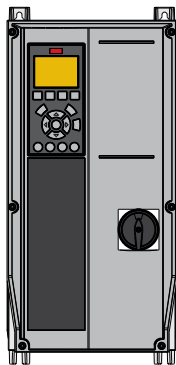

A4 IP55 with mains disconnect

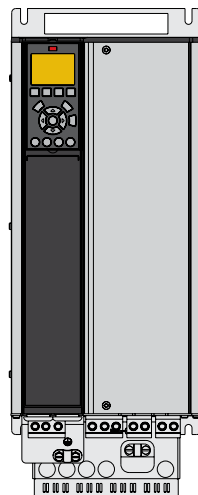

B4 IP20

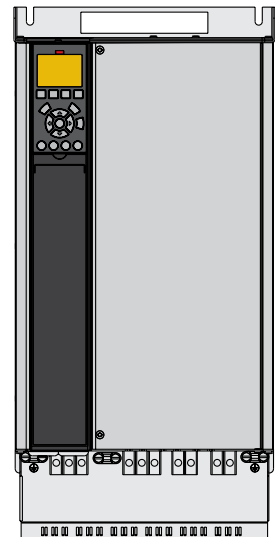

C3 IP20

Electrical data – D, E and F enclosures

[T5] 3 x 380-500 V AC – high overload

Type code	High overload (150% 1 min/10 min)								Enclosure size		
	Output current				Typical shaft output power		Continuous input current	Estimated power loss	Protection rating [IEC/UL]		
	(3 x 380-440 V)		(3 x 441-500 V)						IP20	IP21	IP54
FC-302	Con. I _N	Inter. I _{MAX} (60 s)	Con. I _N	Inter. I _{MAX} (60 s)	kW @ 400 V	Hp @ 460 V	[A]	[W]	Chassis	Type 1	Type 12
N90K	177	266	160	240	90	125	171	2031	D3h	D1h/D5h/D6h	
N110	212	318	190	285	110	150	204	2289	D3h	D1h/D5h/D6h	
N132	260	390	240	360	132	200	251	2923	D3h	D1h/D5h/D6h	
N160	315	473	302	453	160	250	304	3093	D4h	D2h/D7h/D8h	
N200	395	593	361	542	200	300	381	4039	D4h	D2h/D7h/D8h	
N250	480	720	443	665	250	350	463	5005	D4h	D2h/D7h/D8h	
N315	600	900	540	810	315	450	578	6178	E3h	E1h	E1h
N355	658	987	590	885	355	500	634	6851	E3h	E1h	E1h
N400	695	1043	678	1017	400	550	670	7297	E3h	E1h	E1h
N450	800	1200	730	1095	450	600	771	8352	E4h	E2h	E2h
N500	880	1320	780	1170	500	650	848	9449	E4h	E2h	E2h
P450	800	1200	730	1095	450	600	779	9031	–	F1/F3	F1/F3
P500	880	1320	780	1170	500	650	857	10146	–	F1/F3	F1/F3
P560	990	1485	890	1335	560	750	964	10649	–	F1/F3	F1/F3
P630	1120	1680	1050	1575	630	900	1090	12490	–	F1/F3	F1/F3
P710	1260	1890	1160	1740	710	1000	1227	14244	–	F2/F4	F2/F4
P800	1460	2190	1380	2070	800	1200	1422	15466	–	F2/F4	F2/F4

[T5] 3 x 380-500 V AC – normal overload

Type code	Normal overload (110% 1 min/10 min)								Enclosure size		
	Output current				Typical shaft output power		Continuous input current	Estimated power loss	Protection rating [IEC/UL]		
	(3 x 380-440 V)		(3 x 441-500 V)						IP20	IP21	IP54
FC-302	Con. I _N	Inter. I _{MAX} (60 s)	Con. I _N	Inter. I _{MAX} (60 s)	kW @ 400 V	Hp @ 460 V	[A]	[W]	Chassis	Type 1	Type 12
N90K	212	233	190	209	110	150	204	2559	D3h	D1h/D5h/D6h	
N110	260	286	240	264	132	200	251	2954	D3h	D1h/D5h/D6h	
N132	315	347	302	332	160	250	304	3770	D3h	D1h/D5h/D6h	
N160	395	435	361	397	200	300	381	4116	D4h	D2h/D7h/D8h	
N200	480	528	443	487	250	350	463	5137	D4h	D2h/D7h/D8h	
N250	588	647	535	588	315	450	567	6674	D4h	D2h/D7h/D8h	
N315	658	724	590	649	355	500	634	6928	E3h	E1h	E1h
N355	745	820	678	746	400	600	718	8036	E3h	E1h	E1h
N400	800	880	730	803	450	600	771	8783	E3h	E1h	E1h
N450	880	968	780	858	500	650	848	9473	E4h	E2h	E2h
N500	990	1089	890	979	560	750	954	11102	E4h	E2h	E2h
P450	880	968	780	858	500	650	857	10162	–	F1/F3	F1/F3
P500	990	1089	890	979	560	750	964	11822	–	F1/F3	F1/F3
P560	1120	1232	1050	1155	630	900	1090	12512	–	F1/F3	F1/F3
P630	1260	1386	1160	1276	710	1000	1227	14674	–	F1/F3	F1/F3
P710	1460	1606	1380	1518	800	1200	1422	17293	–	F2/F4	F2/F4
P800	1720	1892	1530	1683	1000	1350	1675	19278	–	F2/F4	F2/F4

[T7] 3 x 525-690 V AC – high overload

High overload (150% 1 min/10 min)									Enclosure size		
Type code	Output current				Typical shaft output power		Continuous input current	Estimated power loss	Protection rating [IEC/UL]		
	(3 x 525-550 V)		(3 x 551-690 V)						IP20	IP21	IP54
FC-302	Con. I _N	Inter. I _{MAX} (60 s)	Con. I _N	Inter. I _{MAX} (60 s)	kW @ 690 V	Hp @ 575 V	[A]	[W]	Chassis	Type 1	Type 12
N55K	76	114	73	110	55	60	77	1056	D3h	D1h/D5h/D6h	
N75K	90	135	86	129	75	75	89	1204	D3h	D1h/D5h/D6h	
N90K	113	170	108	162	90	100	110	1479	D3h	D1h/D5h/D6h	
N110	137	206	131	197	110	125	130	1798	D3h	D1h/D5h/D6h	
N132	162	243	155	233	132	150	158	2157	D3h	D1h/D5h/D6h	
N160	201	302	192	288	160	200	198	2443	D4h	D2h/D7h/D8h	
N200	253	380	242	363	200	250	245	3121	D4h	D2h/D7h/D8h	
N250	303	455	290	435	250	300	299	3768	D4h	D2h/D7h/D8h	
N315	360	540	344	516	315	350	355	4254	D4h	D2h/D7h/D8h	
N355	395	593	380	570	355	400	381	4989	E3h	E1h	E1h
N400	429	644	410	615	400	400	413	5419	E3h	E1h	E1h
N500	523	785	500	750	500	500	504	6833	E3h	E1h	E1h
N560	596	894	570	855	560	600	574	8069	E3h	E1h	E1h
N630	659	989	630	945	630	650	635	8543	E4h	E2h	E2h
N710	763	1145	730	1095	710	750	735	10319	E4h	E2h	E2h
P630	659	989	630	945	630	650	642	7826	–	F1/ F3	F1/ F3
P710	763	1145	730	1095	710	750	743	8983	–	F1/ F3	F1/ F3
P800	889	1334	850	1275	800	950	866	10646	–	F1/ F3	F1/ F3
P900	988	1482	945	1418	900	1050	962	11681	–	F2/ F4	F2/ F4
P1M0	1108	1662	1060	1590	1000	1150	1079	12997	–	F2/ F4	F2/ F4
P1M2	1317	1976	1260	1890	1200	1350	1282	15763	–	F2/ F4	F2/ F4

[T7] 3 x 525-690 V AC – normal overload

Normal overload (110% 1 min/10 min)									Enclosure size		
Type code	Output current				Typical shaft output power		Continuous input current	Estimated power loss	Protection rating [IEC/UL]		
	(3 x 525-550 V)		(3 x 551-690 V)						IP20	IP21	IP54
FC-302	Con. I _N	Inter. I _{MAX} (60 s)	Con. I _N	Inter. I _{MAX} (60 s)	kW @ 690 V	Hp @ 575 V	[A]	[W]	Chassis	Type 1	Type 12
N55K	90	99	86	95	75	75	89	1203	D3h	D1h/D5h/D6h	
N75K	113	124	108	119	90	100	110	1476	D3h	D1h/D5h/D6h	
N90K	137	151	131	144	110	125	130	1796	D3h	D1h/D5h/D6h	
N110	162	178	155	171	132	150	158	2165	D3h	D1h/D5h/D6h	
N132	201	221	192	211	160	200	198	2738	D3h	D1h/D5h/D6h	
N160	253	278	242	266	200	250	245	3172	D4h	D2h/D7h/D8h	
N200	303	333	290	319	250	300	299	3848	D4h	D2h/D7h/D8h	
N250	360	396	344	378	315	350	355	4610	D4h	D2h/D7h/D8h	
N315	418	460	400	440	400	400	408	5150	D4h	D2h/D7h/D8h	
N355	470	517	450	495	450	450	453	6062	E3h	E1h	E1h
N400	523	575	500	550	500	500	504	6879	E3h	E1h	E1h
N500	596	656	570	627	560	600	574	8076	E3h	E1h	E1h
N560	630	693	630	693	630	650	607	9208	E3h	E1h	E1h
N630	763	839	730	803	710	750	735	10346	E4h	E2h	E2h
N710	889	978	850	935	800	950	857	12723	E4h	E2h	E2h
P630	763	839	730	803	710	750	743	9212	–	F1/ F3	F1/ F3
P710	889	978	850	935	800	950	866	10659	–	F1/ F3	F1/ F3
P800	988	1087	945	1040	900	1050	962	12080	–	F1/ F3	F1/ F3
P900	1108	1219	1060	1166	1000	1150	1079	13305	–	F2/ F4	F2/ F4
P1M0	1317	1449	1260	1386	1200	1350	1282	15865	–	F2/ F4	F2/ F4
P1M2	1479	1627	1415	1557	1400	1550	1440	18173	–	F2/ F4	F2/ F4

Dimensions enclosure size D

Enclosure size		VLT® AutomationDrive									
Protection rating [IEC/UL]		IP21 /Type 1 IP54 /Type 12		IP20 /Chassis				IP21 /Type 1 IP54 /Type 12			
[mm]	Height	901.0	1107.0	909.0	1026.5	1122.0	1293.8	1324.0	1663.0	1978.0	2284.0
	Width	325.0	420.0	250.0	250.0	350.0	350.0	325.0	325.0	420.0	420.0
	Depth	378.4	378.4	375.0	375.0	375.0	375.0	381.0	381.0	386.0	406.0
[kg]	Weight	62.0	125.0	62.0	108.0	125.0	179.0	99.0	128.0	185.0	232.0
[in]	Height	35.5	43.6	35.8	39.6	44.2	50.0	52.1	65.5	77.9	89.9
	Width	12.8	12.8	19.8	9.9	14.8	13.8	12.8	12.8	16.5	16.5
	Depth	14.9	14.9	14.8	14.8	14.8	14.8	15.0	15.0	15.2	16.0
[lb]	Weight	136.7	275.6	136.7	238.1	275.6	394.6	218.3	282.2	407.9	511.5

- ⁽¹⁾ dimensions with regeneration or load share terminals
- ⁽²⁾ D5h is used with disconnect and/or brake chopper options
- ⁽³⁾ D6h is used with contactor and/or circuit breaker options
- ⁽⁴⁾ D7h is used with disconnect and/or brake chopper options
- ⁽⁵⁾ D8h is used with contactor and/or circuit breaker options

Dimensions enclosure sizes E and F

Frame		VLT® AutomationDrive							
Protection rating [IEC/UL]		IP21 /Type 1 IP54 /Type 12		IP20 /Chassis IP21 /Type 1		IP21 /Type 1 IP54 /Type 12			
[mm]	Height	2043.0	2043.0	1578.0	1578.0	2204.0	2204.0	2204.0	2204.0
	Width	602.0	698.0	506.0	604.0	1400.0	1800.0	2000.0	2400.0
	Depth	513.0	513.0	482.0	482.0	606.0	606.0	606.0	606.0
[kg]	Weight	295.0	318.0	272.0	295.0	1017.0	1260.0	1318.0	1561.0
[in]	Height	80.4	80.4	62.1	62.1	86.8	86.8	86.8	86.8
	Width	23.7	27.5	199.9	23.9	55.2	70.9	78.8	94.5
	Depth	20.2	20.2	19.0	19.0	23.9	23.9	23.9	23.9
[lb]	Weight	650.0	700.0	600.0	650.0	2242.1	2777.9	2905.7	3441.5

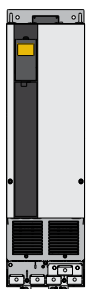

D3h/D4h

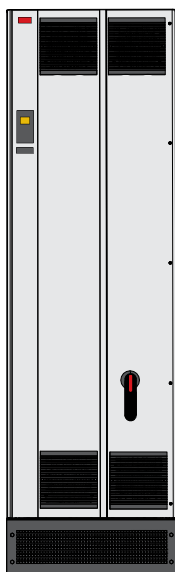

E1h



F

Electrical data and dimensions – VLT® 12-Pulse

[T5] 6 x 380-500 V AC – high overload

Type code	High overload (150% 1 min/10 min)								Enclosure size			
	Output current				Typical shaft output power		Continuous input current	Estimated power loss	Protection rating [IEC/UL]			
	(3 x 380-440 V)		(3 x 441-500 V)						IP21/Type 1		IP54/Type 12	
FC-302	Con. I _N	Inter. I _{MAX} (60 s)	Con. I _N	Inter. I _{MAX} (60 s)	kW @ 400 V	Hp @ 460 V	[A]	[W]	AC drive	+ options	AC drive	+ options
P250	480	720	443	665	250	350	472	5164	F8	F9	F8	F9
P315	600	900	540	810	315	450	590	6960	F8	F9	F8	F9
P355	658	987	590	885	355	500	647	7691	F8	F9	F8	F9
P400	695	1043	678	1017	400	550	684	8178	F8	F9	F8	F9
P450	800	1200	730	1095	450	600	779	9492	F10	F11	F10	F11
P500	880	1320	780	1170	500	650	857	10631	F10	F11	F10	F11
P560	990	1485	890	1335	560	750	964	11263	F10	F11	F10	F11
P630	1120	1680	1050	1575	630	900	1090	13172	F10	F11	F10	F11
P710	1260	1890	1160	1740	710	1000	1227	14967	F12	F13	F12	F13
P800	1460	2190	1380	2070	800	1200	1422	16392	F12	F13	F12	F13

[T5] 6 x 380-500 V AC – normal overload

Type code	Normal overload (110% 1 min/10 min)								Enclosure size			
	Output current				Typical shaft output power		Continuous input current	Estimated power loss	Protection rating [IEC/UL]			
	(3 x 380-440 V)		(3 x 441-500 V)						IP21/Type 1		IP54/Type 12	
FC-302	Con. I _N	Inter. I _{MAX} (60 s)	Con. I _N	Inter. I _{MAX} (60 s)	kW @ 400 V	Hp @ 460 V	[A]	[W]	AC drive	+ options	AC drive	+ options
P250	600	660	540	594	315	450	590	6790	F8	F9	F8	F9
P315	658	724	590	649	355	500	647	7701	F8	F9	F8	F9
P355	745	820	678	746	400	600	733	8879	F8	F9	F8	F9
P400	800	880	730	803	450	600	787	9670	F8	F9	F8	F9
P450	880	968	780	858	500	650	857	10647	F10	F11	F10	F11
P500	990	1089	890	979	560	750	964	12338	F10	F11	F10	F11
P560	1120	1232	1050	1155	630	900	1090	13201	F10	F11	F10	F11
P630	1260	1386	1160	1276	710	1000	1227	15436	F10	F11	F10	F11
P710	1460	1606	1380	1518	800	1200	1422	18084	F12	F13	F12	F13
P800	1720	1892	1530	1683	1000	1350	1675	20358	F12	F13	F12	F13

[T7] 6 x 525-690 V AC – high overload

High overload (150% 1 min/10 min)									Enclosure size			
Type code	Output current				Typical shaft output power		Continuous input current	Estimated power loss	Protection rating [IEC/UL]			
	(3 x 525-550 V)		(3 x 551-690 V)						IP21/Type 1		IP54/Type 12	
FC-302	Con. I _N	Inter. I _{MAX} (60 s)	Con. I _N	Inter. I _{MAX} (60 s)	kW @ 690 V	Hp @ 575 V	[A]	[W]	AC drive	+ options	AC drive	+ options
P355	395	593	380	570	355	400	381	4589	F8	F9	F8	F9
P450	429	644	410	615	400	400	413	4970	F8	F9	F8	F9
P500	523	785	500	750	500	500	504	6707	F8	F9	F8	F9
P560	596	894	570	855	560	600	574	7633	F8	F9	F8	F9
P630	659	989	630	945	630	650	642	8388	F10	F11	F10	F11
P710	763	1145	730	1095	710	750	743	9537	F10	F11	F10	F11
P800	889	1334	850	1275	800	950	866	11291	F10	F11	F10	F11
P900	988	1482	945	1418	900	1050	962	12524	F12	F13	F12	F13
P1M0	1108	1662	1060	1590	1000	1150	1079	13801	F12	F13	F12	F13
P1M2	1317	1976	1260	1890	1200	1350	1282	16719	F12	F13	F12	F13

[T7] 6 x 525-690 V AC – normal overload

Normal overload (110% 1 min/10 min)									Enclosure size			
Type code	Output current				Typical shaft output power		Continuous input current	Estimated power loss	Protection rating [IEC/UL]			
	(3 x 525-550 V)		(3 x 551-690 V)						IP21/Type 1		IP54/Type 12	
FC-302	Con. I _N	Inter. I _{MAX} (60 s)	Con. I _N	Inter. I _{MAX} (60 s)	kW @ 690 V	Hp @ 575 V	[A]	[W]	AC drive	+ options	AC drive	+ options
P355	470	517	450	495	450	450	453	5529	F8	F9	F8	F9
P450	523	575	500	550	500	500	504	6239	F8	F9	F8	F9
P500	596	656	570	627	560	600	574	7653	F8	F9	F8	F9
P560	630	693	630	693	630	650	607	8495	F8	F9	F8	F9
P630	763	839	730	803	710	750	743	9863	F10	F11	F10	F11
P710	889	978	850	935	800	950	866	11304	F10	F11	F10	F11
P800	988	1087	945	1040	900	1050	962	12798	F10	F11	F10	F11
P900	1108	1219	1060	1166	1000	1150	1079	13801	F12	F13	F12	F13
P1M0	1317	1449	1260	1386	1200	1350	1282	16821	F12	F13	F12	F13
P1M2	1479	1627	1415	1557	1400	1550	1440	19247	F12	F13	F12	F13

Dimensions enclosure size F

		VLT® AutomationDrive					
Enclosure size		F8	F9	F10	F11	F12	F13
Protection rating [IEC/UL]		IP21/Type 1 IP54/Type 12					
[mm]	Height	2204.0	2204.0	2204.0	2204.0	2204.0	2204.0
	Width	800.0	1400.0	1600.0	2400.0	2000.0	2800.0
	Depth	606.0	606.0	606.0	606.0	606.0	606.0
[kg]	Weight	447.0	669.0	893.0	1116.0	1037.0	1259.0
[in]	Height	86.8	86.8	86.8	86.8	86.8	86.8
	Width	31.5	55.2	63.0	94.5	78.8	110.2
	Depth	23.9	23.9	23.9	23.9	23.9	23.9
[lb]	Weight	985.5	1474.9	1968.8	2460.4	2286.4	2775.7

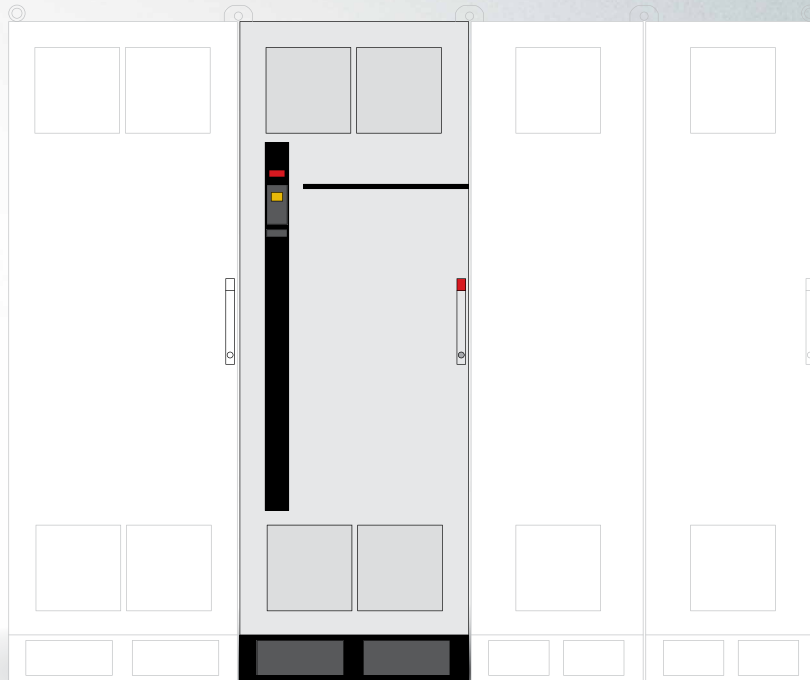

VLT® 12-pulse

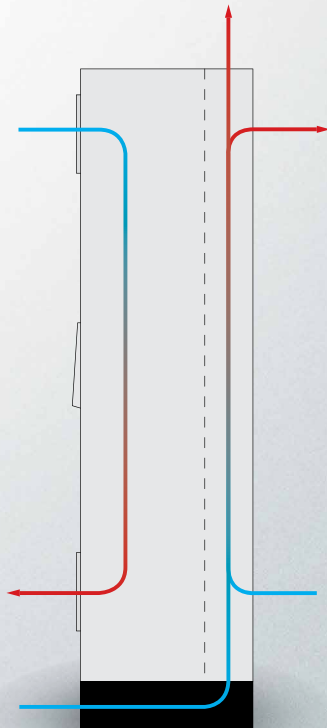

VLT® 12-pulse

Electrical data – VLT® Low Harmonic Drive and VLT® Advanced Active Filters

[T5] 3 x 480 V AC – VLT® Low Harmonic Drive

Type code	High overload (150% 1 min/10 min)								Enclosure size	
	Output current				Typical shaft output power		Continuous input current	Estimated power loss	Protection rating [IEC/UL]	
	(3 x 380-440 V)		(3 x 441-480 V)						IP21	IP54
FC-302	Con. I _N	Inter. I _{MAX} (60 s)	Con. I _N	Inter. I _{MAX} (60 s)	kW @ 400 V	Hp @ 460 V	[A]	[W]	Type 1	Type 12
N132	260	390	240	360	132	200	251	7428	D1n	D1n
N160	315	473	302	453	160	250	304	8048	D2n	D2n
N200	395	593	361	542	200	300	381	9753	D2n	D2n
N250	480	720	443	665	250	350	472	11587	E9	E9
P315	600	900	540	810	315	450	590	14140	E9	E9
P355	658	987	590	885	355	500	647	15286	E9	E9
P400	695	1043	678	1017	400	550	684	16063	E9	E9

[T5] 3 x 480 V AC – VLT® Low Harmonic Drive

Type code	Normal overload (110% 1 min/10 min)								Enclosure size	
	Output current				Typical shaft output power		Continuous input current	Estimated power loss	Protection rating [IEC/UL]	
	(3 x 380-440 V)		(3 x 441-480 V)						IP21	IP54
FC-302	Con. I _N	Inter. I _{MAX} (60 s)	Con. I _N	Inter. I _{MAX} (60 s)	kW @ 400 V	Hp @ 460 V	[A]	[W]	Type 1	Type 12
N132	315	347	302	332	160	250	304	8725	D1n	D1n
N160	395	435	361	397	200	300	381	9831	D2n	D2n
N200	480	528	443	487	250	350	463	11371	D2n	D2n
N250	600	660	540	594	315	450	590	14051	E9	E9
P315	658	724	590	649	355	500	647	15320	E9	E9
P355	745	820	678	746	400	600	733	17180	E9	E9
P400	800	880	730	803	450	600	787	18447	E9	E9

[T4] 3 x 380-480 V AC VLT® Advanced Active Filter

Type code	Normal overload (110% 1 min/10min automatically regulated)									Enclosure size		
	Corrected Current								Recommended fuse and disconnect*	Estimated power loss	Protection rating [IEC/UL]	
	@ 400 V		@ 460 V		@ 480 V		@ 500 V				IP21	IP54
AAF006	Cont.	Int.	Cont.	Int.	Cont.	Int.	Cont.	Int.	[A]	[W]	Type 1	Type 12
A190	260	390	240	360	260	390	240	360	350	5000	D14	D14
A250	315	473	302	453	315	473	302	453	630	7000	E1	E1
A310	395	593	361	542	395	593	361	542	630	9000	E1	E1
A400	480	720	443	665	480	720	443	665	900	11100	E1	E1

* Built-in options for fuses and disconnect recommended

Typecode VLT® Advanced Active Filter

The different VLT® Active Filters can easily be configured according to customer request at drives.danfoss.com

1	2	3	4	5	6	7	8	9	10	11	12	13	14	15	16	17	18	19	20	21	22	23	24	..	39
A	A	F	0	0	6	A	x	x	x	T	4	E	x	x	H	x	x	G	C	x	x	x	S	.	X

8-10:
190: 190 A correction current
250: 250 A correction current
310: 310 A correction current
400: 400 A correction current

13-15:
E21: IP 21/NEMA 1
E2M: IP 21/NEMA 1 w. mains shield
C2M: IP 21/NEMA 1 w. stainless steel back-channel and mains shield

E54: IP 54/NEMA 12
E5M: IP 54/NEMA 12 w. mains shield
C5M: IP 54/NEMA 12 w. stainless steel back-channel and mains shield

16-17:
HX: No RFI Filter
H4: RFI class A1

21:
X: No mains options
3: Disconnect & Fuse
7: Fuse

Dimensions – VLT® Low Harmonic Drive and VLT® Advanced Active Filter

Enclosure size		VLT® Low Harmonic Drive			VLT® Advanced Active Filter	
		D1n	D2n	E9	D14	E1
Protection rating [IEC/UL]		IP21 /Type 1 IP54 /Type 12			IP21 /Type 1 IP54 /Type 12	
[mm]	Height	1915.91	1914.7	2000.7	1780.0	2000.0
	Width	929.2	1024.2	1200.0	600.0	600.0
	Depth	418.4	418.4	538.0	418.4	538.0
[kg]	Weight	353.0	413.0	676.0	238.0	453.0
[in]	Height	75.4	75.4	78.8	70.0	78.7
	Width	36.6	40.3	47.2	23.6	23.6
	Depth	16.5	16.5	21.0	16.5	21.0
[lb]	Weight	777.0	910.0	1490.0	524.7	998.7

Specifications VLT® Advanced Active Filter

Filter type	3P/3W, Active Shunt Filter (TN, TT, IT)	Individual harmonic current allocation in selective mode	I5: 63%, I7: 45%, I11: 29%, I13: 25%, I17: 18%, I19: 16%, I23: 14%, I25: 13%
Frequency	50 to 60 Hz, ± 5%	Reactive current compensation	Yes, leading (capacitive) or lagging (inductive) to target power factor
Enclosures	IP21 – NEMA 1, IP54 – NEMA 12	Flicker reduction	Yes
Max. voltage pre-distortion	10% 20% with reduced performance	Compensation priority	Programmable to harmonics or displacement power factor
Operating temperature	0-40 °C +5 °C with reduced performance -10 °C with reduced performance	Paralleling option	Up to 4 units of same power rating in master follower
Altitude	1000 m without derating 3000 m with reduced performance (5%/1000 m)	Current Transformer Support (Customer supply and field mounting)	1 A and 5 A secondary with auto tuning Class 0.5 or better
EMC standards	IEC61000-6-2 IEC61000-6-4	Digital inputs /outputs	4 (2 programmable) Programmable PNP or NPN logic
Circuitry coating	Conformal coated – per ISA S71.04-1985, class G3	Communication interface	RS485, USB1.1
Languages	18 different	Control type	Direct harmonic control (for faster response)
Harmonic compensation modes	Selective or overall (90% RMS for harmonic reduction)	Response time	< 15 ms (including HW)
Harmonic compensation spectrum	2 nd to 40 th in overall mode, including triplens 5 th , 7 th , 11 th , 13 th , 17 th , 19 th , 23 rd , 25 th in selective mode	Harmonic settling time (5-95%)	< 15 ms
		Reactive settling time (5-95%)	< 15 ms
		Maximum overshoot	5%
		Switching frequency	Progressive control in the range of 3 – 18 kHz
		Average switching frequency	3 – 4.5 kHz

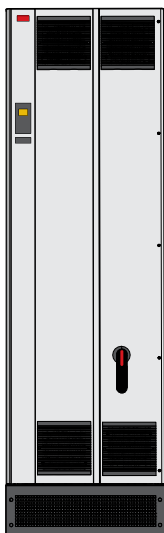

VLT® Advanced Active Filter AAF 006

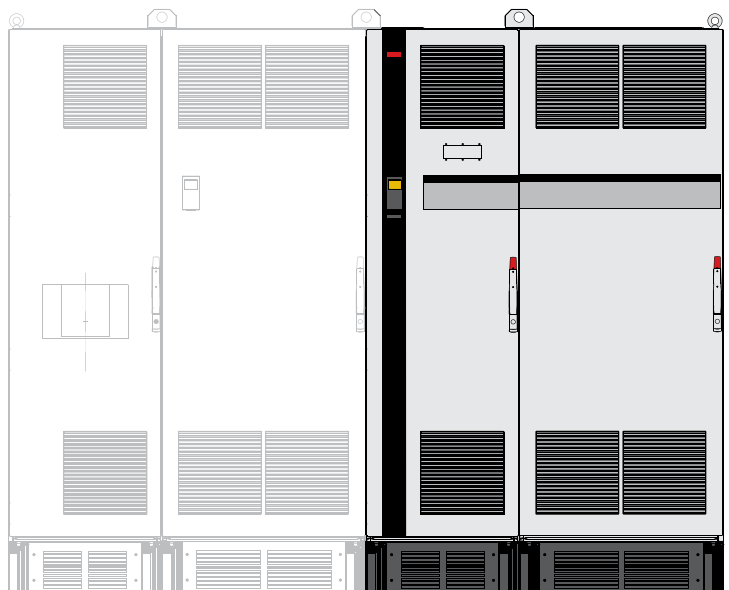

VLT® Low Harmonic Drive

A options: Fieldbuses

Available for the full product range

Fieldbus	Typecode position
A	
VLT® PROFIBUS DP MCA 101	14
VLT® DeviceNet MCA 104	
VLT® CANopen MCA 105	
VLT® 3000 PROFIBUS Converter MCA 113	
VLT® 5000 PROFIBUS Converter MCA 114	
VLT® PROFINET MCA 120	
VLT® EtherNet/IP MCA 121	
VLT® Modbus TCP MCA 122	
VLT® POWERLINK MCA 123	
VLT® EtherCAT MCA 124	
VLT® 5000 DeviceNet Converter MCA 194	

PROFIBUS DP

Operating the AC drive via a fieldbus enables you to reduce the cost of your system, communicate faster and more efficiently and benefit from an easier user interface.

Other features:

- Wide compatibility, a high level of availability, support for all major PLC vendors, and compatibility with future versions
- Fast, efficient communication, transparent installation, advanced diagnosis and parameterization and auto-configuration of process data via GSD-file
- Acyclic parameterization using PROFIBUS DP-V1, PROFIdrive or Danfoss FC (MCA101 only) profile state machines, PROFIBUS DP-V1, Master Class 1 and 2

VLT® PROFIBUS DP MCA 101

Order code

130B1100 standard
130B1200 coated

DeviceNet

DeviceNet offers robust, efficient data handling thanks to advanced Producer/Consumer technology.

- Support of ODVA's AC drive profile supported via I/O instance 20/70 and 21/71 secures compatibility to existing systems
- Benefit from ODVA's strong conformance testing policies, which ensure that products are interoperable
- Built-in web server
- E-mail client for service notification

VLT® DeviceNet MCA 104

Order code

130B1102 standard
130B1202 coated

CANopen

High flexibility and low cost are two of the "cornerstones" for CANopen.

The CANopen option is fully equipped with both high-priority access to control and status of the drive (PDO Communication) and access all parameters through acyclic data (SDO Communication).

For interoperability, the option has implemented the DSP402 AC drive Profile. These features all guarantee standardized handling, interoperability and low cost.

VLT® CANopen MCA 105

Order code

130B1103 standard
130B1205 coated

VLT® 3000 PROFIBUS Converter

The VLT® PROFIBUS Converter MCA 113 is a special version of the PROFIBUS options that emulates the VLT® 3000 commands in the VLT® AutomationDrive.

The VLT® 3000 can be replaced by the VLT® AutomationDrive, or an existing system can be expanded without costly change of the PLC program.

VLT® 3000 PROFIBUS Converter MCA 113

Order code

130B1245 coated

VLT® 5000 PROFIBUS Converter

The VLT® PROFIBUS Converter MCA 114 is a special version of the PROFIBUS options that emulates the VLT® 5000 commands in the VLT® AutomationDrive.

The VLT® 5000 can be replaced by the VLT® AutomationDrive, or an existing system can be expanded without costly change of the PLC program.

The option supports DPV1.

VLT® 5000 PROFIBUS Converter MCA 114

Order code

130B1246 coated

PROFINET

PROFINET uniquely combines the highest performance with the highest degree of openness. The option is designed so that many of the features from the PROFIBUS can be reused, minimizing user effort to migrate PROFINET and securing the investment in a PLC program.

- Same PPO types as PROFIBUS for easy migration to PROFINET
- Support of MRP
- Support of DP-V1 Diagnostic allows easy, fast and standardized handling of warning and fault information into the PLC, improving bandwidth in the system
- Implementation in accordance with Conformance Class B
- Built-in web server
- E-mail client for service notification

VLT® PROFINET MCA 120

Order code

130B1135 standard, dual-port
130B1235 coated, dual-port

EtherNet/IP

Ethernet is the future standard for communication at the factory floor. EtherNet/IP is based on the newest technology available for industrial use and handles even the most demanding requirements.

EtherNet/IP™ extends commercial off-the-shelf Ethernet to the Common Industrial Protocol (CIP™) – the same upper-layer protocol and object model found in DeviceNet.

The option offers advanced features such as:

- Built-in high performance switch enabling line-topology, and eliminating the need for external switches
- DLR Ring
- Advanced switch and diagnosis functions
- Built-in web server
- E-mail client for service notification
- Unicast and Multicast communication

VLT® EtherNet/IP MCA 121

Order code

130B1119 standard, dual-port
130B1219 coated, dual-port

Modbus TCP

Modbus TCP is the first industrial Ethernet-based protocol for automation. Modbus TCP is able to handle connection intervals down to 5 ms in both directions, positioning it among the fastest performing Modbus TCP devices in the market. For master redundancy, it features hot swapping between two masters.

Other features:

- Dual Master PLC connection for redundancy in dual port options (MCA 122 only)

VLT® Modbus TCP MCA 122

Order code

130B1196 standard, dual-port
130B1296 coated, dual-port

POWERLINK

POWERLINK represents the second generation of fieldbus. The high bit rate of industrial Ethernet can now be used to make the full power of IT technologies used in the automation world available for the factory world.

POWERLINK provides high performance real-time and time synchronization features. Due to its CANopen-based communication models, network management and device description model, it offers much more than just a fast communication network.

The perfect solution for:

- Dynamic motion control applications
- Material handling

- Synchronization and positioning applications
- Built-in web server
- E-mail client for service notification

VLT® POWERLINK MCA 123

Order code

130B1489 standard, dual-port
130B1490 coated, dual-port

EtherCAT

The EtherCAT offers connectivity to EtherCAT®-based networks via the EtherCAT Protocol.

The option handles the EtherCAT line communication in full speed, and connection towards the drive with an interval down to 4 ms in both directions. This allows the option to participate in networks ranging from low performance up to servo applications.

- EoE Ethernet over EtherCAT support
- HTTP (Hypertext Transfer Protocol) for diagnosis via built-in web server
- CoE (CAN Over Ethernet) for access to drive parameters
- SMTP (Simple Mail Transfer Protocol) for e-mail notification
- TCP/IP for easy access to drive configuration data from MCT 10

VLT® EtherCAT MCA 124

Order code

130B5546 standard
130B5646 coated

VLT® DeviceNet Converter

The VLT® DeviceNet Converter MCA 194 emulates VLT® 5000 commands in the VLT® AutomationDrive.

This means that a VLT® 5000 drive can be replaced by the VLT® AutomationDrive, or a system can be expanded without costly change of the PLC program.

The option emulates I/O instances and explicit messages of a VLT® 5000.

VLT® DeviceNet Converter MCA 194

Order code

130B5601 coated

B options: Functional extensions

Available for the full product range

Functional extensions	Typecode position
B	
VLT® General Purpose MCB 101	15
VLT® Encoder Input MCB 102	
VLT® Resolver Input MCB 103	
VLT® Relay Option MCB 105	
VLT® Safety PLC I/O MCB 108	
VLT® Analog I/O Option MCB 109	
VLT® PTC Thermistor Card MCB 112	
VLT® Sensor Input Card MCB 114	
VLT® Safety Option MCB 150 TTL	
VLT® Safety Option MCB 151 HTL	
VLT® Safety Option MCB 152 PROFIsafe STO	

VLT® General Purpose I/O MCB 101

This I/O option offers an extended number of control inputs and outputs:

- 3 digital inputs 0-24 V: Logic '0' < 5 V; Logic '1' > 10V
- 2 analog inputs 0-10 V: Resolution 10 bit plus sign
- 2 digital outputs NPN/PNP push pull
- 1 analog output 0/4-20 mA
- Spring-loaded connection

Ordering number

130B1125 standard
130B1212 coated (Class 3C3/IEC 60721-3-3)

VLT® Encoder Input MCB 102

This option offers the possibility to connect various types of incremental and absolute encoders. The connected encoder can be used for closed loop speed/position control as well as closed loop flux motor control.

The following encoder types are supported:

- 5V TTL (RS 422)
- 1VPP SinCos
- SSI
- Hiperface
- EnDat 2.1 and 2.2

Ordering number

130B1115 standard
130B1203 coated (Class 3C3/IEC 60721-3-3)

VLT® Resolver Input MCB 103

This option enables connection of a resolver to provide speed feedback from the motor.

- Primary voltage 2-8 Vrms
- Primary frequency 2.0-15 kHz
- Primary current max. 50 mA rms
- Secondary input voltage 4 Vrms
- Spring-loaded connection

Ordering number

130B1127 standard
130B1227 coated (Class 3C3/IEC 60721-3-3)

VLT® Relay Card MCB 105

Makes it possible to extend relay functions with 3 additional relay outputs.

- Max. switch rate at rated load/min. load 6 min⁻¹/20 sec⁻¹
- Protects control cable connection
- Spring-loaded control wire connection

Max. terminal load:

- AC-1 Resistive load 240 V AC 2 A
- AC-15 Inductive load @cos phi 0.4 240 V AC 0.2 A
- DC-1 Resistive load 24 V DC 1 A
- DC-13 Inductive load @cos phi 0.4 24 V DC 0.1 A

Min. terminal load:

- DC 5 V 10 mA

Ordering number

130B1110 standard
130B1210 coated (Class 3C3/IEC 60721-3-3)

VLT® Safe PLC I/O MCB 108

The VLT® AutomationDrive FC 302 provides a safety input based on a single-pole 24 V DC input.

- For the majority of applications, this input enables the user to implement safety in a cost-effective way. For applications that work with more advanced products like Safety PLC and light curtains, the Safe PLC interface enables the connection of a two-wire safety link
- The Safe PLC Interface allows the Safe PLC to interrupt on the plus or the minus link without interfering the sense signal of the Safe PLC

Ordering number

130B1120 standard
130B1220 coated (Class 3C3/IEC 60721-3-3)

VLT® Analog I/O Option MCB 109

This analog input/output option is easily fitted in the AC drive for upgrading to advanced performance and control using the additional I/O. This option also upgrades the AC drive with a battery back-up supply for the AC drive built-in clock. This provides stable use of all AC drive clock functions as timed actions.

- 3 analog inputs, each configurable as both voltage and temperature input
- Connection of 0-10 V analog signals as well as Pt1000 and Ni1000 temperature inputs
- 3 analog outputs each configurable as 0-10 V outputs
- Back-up supply for the standard clock function in the AC drive

The back-up battery typically lasts for 10 years, depending on environment.

Ordering number

130B1143 standard
130B1243 coated (Class 3C3/IEC 60721-3-3)

VLT® PTC Thermistor Card MCB 112

The VLT® PTC Thermistor Card MCB 112 enables improved surveillance of the motor condition compared to the built-in ETR function and thermistor terminal.

- Protects the motor from overheating
- ATEX-approved for use with Ex d and Ex e motors
- Uses Safe Torque Off function, which is approved in accordance with SIL 2 IEC 61508

Ordering number

130B1137 coated (Class 3C3/IEC 60721-3-3)

VLT® Sensor Input Card MCB 114

This option protects the motor from being overheated by monitoring the temperature of bearings and windings in the motor.

- Protects the motor from overheating
- 3 self-detecting sensor inputs for 2 or 3 wire PT100/PT1000 sensors
- 1 additional analog input 4-20 mA

Ordering number

130B1172 standard
130B1272 coated (Class 3C3/IEC 60721-3-3)

VLT® Safety Option MCB 150 and MCB 151

The VLT® Safety Options MCB 150 and MCB 151 expand the Safe Torque Off (STO) function, which is integrated in a standard VLT® AutomationDrive. Use the Safe Stop 1 (SS1) function to perform a controlled stop before removing torque. Use the Safely-Limited Speed SLS function to monitor whether a specified speed is exceeded.

The functions can be used up to PLd according to ISO 13849-1 and SIL 2 according to IEC 61508.

- Additional standards-compliant safety functions
- Replacement of external safety equipment
- Reduced space requirements
- 2 safe programmable inputs
- 1 safe output (for T37)
- Easier machine certification
- Drive can be powered continuously
- Safe LCP Copy
- Dynamic commissioning report
- TTL (MCB 150) or HTL (MCB 151) encoder as speed feedback

Ordering number

130B3280 MCB 150, 130B3290 MCB 151

VLT® Safety Option MCB 152

The VLT® Safety Option MCB 152 enables activation of Safe Torque Off (STO) via the PROFIsafe fieldbus in combination with VLT® PROFINET MCA 120 fieldbus option. It improves flexibility by connecting safety devices within a plant.

The safety functions of the MCB 152 are implemented according to EN IEC 61800-5-2. The MCB 152 supports PROFIsafe functionality to activate integrated safety functions of the VLT® AutomationDrive from any PROFIsafe host, up to Safety Integrity Level SIL 2 according to EN IEC 61508 and EN IEC 62061, Performance Level PLd, Category 3 according to EN ISO 13849-1.

- PROFIsafe device (in combination with MCA 120)
- Replacement of external safety equipment
- 2 safe programmable inputs
- Safe LCP copy
- Dynamic commissioning report

Ordering number

130B9860 coated (Class 3C3/IEC 60721-3-3)

C options: Motion control and relay card

Available for the full product range

Motion control and relay card	Typecode position
C	
VLT® Motion Control MCO 305	16
VLT® Synchronizing Control MCO 350	16 and 18
VLT® Positioning Controller MCO 351	16 and 18
VLT® Extended Relay Card MCB 113	17

VLT® Extended Relay Card MCB 113

The VLT® Extended Relay Card MCB 113 adds inputs/outputs for increased flexibility.

- 7 digital inputs
- 2 analog outputs
- 4 SPDT relays
- Meets NAMUR recommendations
- Galvanic isolation capability

Ordering number

130B1164 standard
130B1264 coated (Class 3C3/IEC 60721-3-3)

VLT® Motion Control MCO 305

An integrated programmable motion controller adding extra functionality for VLT® AutomationDrive FC 301 and FC 302.

VLT® Motion Control Option MCO 305 offers easy-to-use motion functions combined with programmability – an ideal solution for positioning and synchronizing applications.

- Synchronization (electronic shaft), positioning and electronic cam control
- 2 separate interfaces supporting both incremental and absolute encoders
- 1 encoder output (virtual master function)
- 10 digital inputs
- 8 digital outputs

- Support of CANopen motion bus, encoders and I/O modules
- Sends and receives data via fieldbus interface (requires fieldbus option)
- PC software tools for debugging and commissioning: Program and Cam editor
- Structured programming language with both cyclic and event-driven execution

Ordering number

130B1134 standard
130B1234 coated (Class 3C3/IEC 60721-3-3)

VLT® Synchronizing Controller MCO 350

The VLT® Synchronizing Controller MCO 350 for VLT® AutomationDrive expands the functional properties of the AC drive in synchronizing applications, and replaces traditional mechanical solutions.

- Speed synchronizing
- Position (angle) synchronizing with or without marker correction
- On-line adjustable gear ratio
- On-line adjustable position (angle) offset
- Encoder output with virtual master function for synchronization of multiple followers
- Control via I/Os or fieldbus
- Home function
- Configuration as well as read-out of status and data via the LCP

Ordering number

130B1152 standard
130B1252 coated (Class 3C3/IEC 60721-3-3)

VLT® Positioning Controller MCO 351

The VLT® Positioning Controller MCO 351 offers a host of user-friendly benefits for positioning applications in many industries.

Features:

- Relative positioning
- Absolute positioning
- Touch-probe positioning
- End-limit handling (software and hardware)
- Control via I/Os or fieldbus
- Mechanical brake handling (programmable hold delay)
- Error handling
- Jog speed/manual operation
- Marker related positioning
- Home function
- Configuration as well as read-out of status and data via the LCP

Ordering number

130B1153 standard
130B1253 coated (Class 3C3/IEC 60721-3-3)

D option: 24 V back-up power supply

Available for the full product range

24 V back-up power supply	Typecode position
D	
VLT® 24 V DC Supply Option MCB 107	19

VLT® 24 V DC Supply MCB 107

Connect an external DC supply to keep the control section and any installed option functioning during power failure.

This enables full operation of the LCP (including the parameter setting) and all installed options without connection to mains.

- Input voltage range 24 V DC +/- 15% (max. 37 V for 10 sec.)
- Max. input current 2.2 A
- Max. cable length 75 m
- Input capacitance load < 10 uF
- Power-up delay < 0.6 s

Ordering number

130B1108 standard
130B1208 coated (Class 3C3/IEC 60721-3-3)

Accessories

Available for the full product range

LCP

VLT® Control Panel LCP 101 (Numeric)

Ordering number: 130B1124

VLT® Control Panel LCP 102 (Graphical)

Ordering number: 130B1107

VLT® Wireless Communication Panel LCP 103

Ordering number: 134B0460

LCP Panel Mounting Kit

Ordering number for IP20 enclosure

130B1113: With fasteners, gasket, graphical LCP and 3 m cable

130B1114: With fasteners, gasket, numerical LCP and 3 m cable

130B1117: With fasteners, gasket and without LCP and with 3 m cable

130B1170: With fasteners, gasket and without LCP

Ordering number for IP55 enclosure

130B1129: With fasteners, gasket, blind cover and 8 m "free end" cable

LCP Remote Mounting Kit

Ordering number:

134B5223 – Kit with 3 m cable:

134B5224 – Kit with 5 m cable

134B5225 – Kit with 10 m cable

Accessories

PROFIBUS SUB-D9 Adapter

IP20, A2 and A3

Ordering number: 130B1112

Option Adapter

Ordering number: 130B1130 standard, 130B1230 coated

Adapter Plate for VLT® 3000 and VLT® 5000

Ordering number: 130B0524 – to be used only for IP20/NEMA type 1 units up to 7.5 kW

USB Extension

Ordering number:

130B1155: 350 mm cable

130B1156: 650 mm cable

IP21/Type 1 (NEMA 1) kit

Ordering number

130B1121: For enclosure size size A1

130B1122: For enclosure size size A2

130B1123: For enclosure size size A3

130B1187: For enclosure size size B3

130B1189: For enclosure size size B4

130B1191: For enclosure size size C3

130B1193: For enclosure size size C4

NEMA 3R outdoor weather shield

Ordering number

176F6302: For enclosure size size D1h

176F6303: For enclosure size size D2h

NEMA 4X outdoor weather shield

Ordering number

130B4598: For enclosure size size A4, A5, B1, B2

130B4597: For enclosure size size C1, C2

Motor connector

Ordering number:

130B1065: enclosure size A2 to A5 (10 pieces)

Mains connector

Ordering number:

130B1066: 10 pieces mains connectors IP55

130B1067: 10 pieces mains connectors IP20/21

Relays 1 terminal

Ordering number: 130B1069 (10 pieces 3 pole connectors for relay 01)

Relays 2 terminal

Ordering number: 130B1068 (10 pieces 3 pole connectors for relay 02)

Control card terminals

Ordering number: 130B0295

VLT® Leakage Current Monitor Module RCMB20/RCMB35

Ordering number:

130B5645: A2-A3

130B5764: B3

130B5765: B4

130B6226: C3

130B5647: C4

PC software

VLT® Motion Control Tool MCT 10

VLT® Motion Control Tool MCT 31

Danfoss HCS Harmonic Calculation Software

VLT® Energy Box

Danfoss ecoSmart™

Power options

Power option

VLT® Sine-Wave Filter MCC 101

VLT® dU/dt Filter MCC 102

VLT® Common Mode Filters MCC 105

VLT® Advanced Harmonic Filter AHF 005/010

VLT® Brake Resistors MCE 101

VLT® Line Reactor MCC 103

VLT® Sine-wave Filter MCC 101

- VLT® Sine-wave Filters are positioned between the AC drive and the motor to provide a sinusoidal phase-to-phase motor voltage
- Reduces motor insulation stress
- Reduces acoustic noise from the motor
- Reduces bearing currents (especially in large motors)
- Reduces losses in the motor
- Prolongs service lifetime
- VLT® FC series family look

Power range

3 x 200-500 V, 2.5-800 A

3 x 525-690 V, 4.5-660 A

Enclosure ratings

- IP00 and IP20 wall-mounted enclosures rated up to 75 A (500 V) or 45 A (690 V)
- IP23 floor-mounted enclosures rated 115 A (500 V) or 76 A (690 V) or more
- IP54 both wall-mounted and floor-mounted enclosures rated up to 4.5 A, 10 A, 22 A (690 V)

Ordering number

See relevant Design Guide

VLT® dU/dt Filter MCC 102

- Reduces the dU/dt values on the motor terminal phase-to-phase voltage
- Positioned between the AC drive and the motor to eliminate very fast voltage changes
- The motor terminal phase-to-phase voltage is still pulse shaped but its dU/dt values are reduced
- Reduces stress on the motor's insulation and are recommended in applications with older motors, aggressive environments or frequent braking which cause increased DC link voltage
- VLT® FC series family look

Power range

3 x 200-690 V (up to 880 A)

Enclosure ratings

- IP00 and IP20/IP23 enclosure in the entire power range
- IP54 enclosure available up to 177 A

Ordering number

See relevant Design Guide

VLT® Common Mode Filter MCC 105

- Positioned between the AC drive and the motor
- They are nano-crystalline cores that mitigate high-frequency noise in the motor cable (shielded or unshielded) and reduce bearing currents in the motor
- Extends motor bearing lifetime
- Can be combined with dU/dt and sine-wave filters
- Reduces radiated emissions from the motor cable
- Reduces electromagnetic interference
- Easy to install – no adjustments necessary
- Oval shaped – allows mounting inside the AC drive enclosure or motor terminal box

Power range

380-415 V AC (50 and 60 Hz)

440-480 V AC (60 Hz)

600 V AC (60 Hz)

500-690 V AC (50 Hz)

Ordering number

130B3257 Enclosure size A and B

130B7679 Enclosure size C1

130B3258 Enclosure size C2, C3 and C4

130B3259 Enclosure size D

130B3260 Enclosure size E and F

VLT® Advanced Harmonic Filter AHF 005 and AHF 010

- Optimized harmonic performance for VLT® drives rated up to 250 kW
- A patented technique reduces THD levels in the mains network to less than 5-10%
- Perfect match for industrial automation, highly dynamic applications and safety installations

Power range

380-415 V AC (50 and 60 Hz)

440-480 V AC (60 Hz)

600 V AC (60 Hz)

500-690 V AC (50 Hz)

Enclosure ratings

- IP20
(An IP21/NEMA 1 upgrade kit is available)
- IP00
(Forced cooling is required. There is no fan in the IP00 unit. Separate cooling measures must be implemented in the cabinet as part of the installation)

Ordering number

See relevant Design Guide

VLT® Brake Resistor MCE 101

- Energy generated during braking is absorbed by the resistors, protecting electrical components from heating up
- Optimized for the FC-series and general versions for horizontal and vertical motion are available
- Built-in thermo switch
- Versions for vertical and horizontal mounting
- A selection of the vertically mounted units are UL-recognized

Power range

Precision electrical match to each individual VLT® drive power size

Enclosure ratings:

- IP20
- IP21
- IP54
- IP65

Ordering number

See relevant Design Guide

VLT® Line Reactor MCC 103

- Ensures current balance in load-sharing applications, where the DC-side of the rectifier of multiple drives is connected together
- UL-recognized for applications using load sharing
- When planning load-sharing applications, pay special attention to different enclosure type combinations and inrush concepts
- For technical advice regarding load-sharing applications, contact Danfoss application support
- Compatible with VLT® AutomationDrive 50 Hz or 60 Hz mains supply

Ordering number

See relevant Design Guide



Accessory compatibility with enclosure size

Overview for enclosure sizes D, E and F only

Enclosure size	Typecode position	D1h/D2h	D3h/D4h	D5h/D7h	D6h/D8h	D1n/D2n	E1h/E2h	E3h/E4h	E9	F1/F2	F3/F4 (w/options cabinet)	F8	F9 (w/options cabinet)	F10/F12	F11/F13 (w/options cabinet)
Enclosure with corrosion-resistant back channel	4	-	□	-	-	-	□	□	-	□	□	-	-	-	-
Mains shielding	4	□	-	□	□	□	□	-	□	■	■	■	■	■	■
Space heaters and thermostat	4	□	-	□	□	-	□	-	-	□	□	-	-	□	□
Cabinet light with power outlet	4	-	-	-	-	-	-	-	-	□	□	-	-	□	□
RFI filters ^(*)	5	□	□	□	□	□	□	□	□	-	□	-	□	-	□
Insulation Resistance Monitor (IRM)	5	-	-	-	-	-	-	-	-	-	□	-	□	-	□
Residual Current Device (RCD)	5	-	-	-	-	-	-	-	-	-	□	-	□	-	□
Brake Chopper (IGBTs)	6	-	□	□	□	□	□	□	□	□	□	□	□	□	□
Safe Torque Off with Pilz Safety Relay	6	□	□	□	□	□	□	□	□	□	□	□	□	□	□
Regeneration terminals	6	-	□	□	□	□	□	□	□	□	□	□	□	□	□
Common Motor Terminals	6	■	■	■	■	■	■	■	■	□	□	■	■	□	□
Emergency Stop with Pilz Safety Relay	6	-	-	-	-	-	-	-	-	-	□	-	-	-	-
Safe Torque Off + Pilz Safety Relay	6	-	-	-	-	-	-	-	-	□	□	□	□	□	□
No LCP	7	□	□	□	□	-	□	□	-	-	-	-	-	-	-
VL ^T Control Panel LCP 101 (Numeric)	7	□	□	□	□	-	-	-	-	-	-	-	-	-	-
VL ^T Control Panel LCP 102 (Graphical)	7	□	□	□	□	■	■	■	■	■	■	■	■	■	■
Fuses	9	□	□	□	-	□	■	□	□	□	□	□	□	□	□
Load sharing terminals	9	-	□	-	-	-	-	□	-	□	□	-	-	-	-
Fuses + load sharing terminals	9	-	□	-	-	-	-	□	-	□	□	-	-	-	-
Disconnect	9 ⁽¹⁾	-	-	-	□	□	□	-	□	-	□	-	□	-	□
Circuit breakers	9 ⁽¹⁾	-	-	-	□	-	-	-	-	-	□	-	-	-	-
Contactors	9 ⁽¹⁾	-	-	-	□	-	-	-	-	-	□	-	-	-	-
Manual motor starters	10	-	-	-	-	-	-	-	-	□	□	-	-	□	□
30 A, fuse-protected terminals	10	-	-	-	-	-	-	-	-	□	□	-	-	□	□
24V DC supply	11	-	-	-	-	-	-	-	-	□	□	-	-	□	□
External temperature monitoring	11	-	-	-	-	-	-	-	-	□	□	-	-	□	□
Heat sink access panel	11	□	□	□	□	-	□	□	-	-	-	-	-	-	-
NEMA 3R ready drive	11	□	-	-	-	-	-	-	-	-	-	-	-	-	-

⁽¹⁾ Options supplied with fuses

^(*) Not available in 690 V

□ Optional

■ Standard

Enclosure with corrosion-resistant back channel

For additional protection from corrosion in harsh environments, units can be ordered in an enclosure that includes a stainless steel back channel, heavier plated heat sinks and an upgraded fan.

This option is recommended in salt-air environments, such as those near the ocean.

Mains shielding

Lexan® shielding can be mounted in front of incoming power terminals and the input plate to protect from accidental contact when the enclosure door is open.

Space heaters and thermostat

Mounted in the cabinet interior of drives with enclosure sizes D and F and controlled via an automatic thermostat, space heaters controlled via an automatic thermostat prevent condensation inside the enclosure.

The thermostat default settings turn on the heaters at 10 °C (50 °F) and turn them off at 15.6 °C (60 °F).

Cabinet light with power outlet

A light can be mounted on the cabinet interior of drives with enclosure size F, to increase visibility during servicing and maintenance. The light housing includes a power outlet for temporarily powering laptop computers or other devices. Available in two voltages:

- 230 V, 50 Hz, 2.5 A, CE/ENEC
- 120 V, 60 Hz, 5 A, UL/CUL

RFI filters

VLT® Series drives feature integrated Class A2 RFI filters as standard. If additional levels of RFI/EMC protection are required, they can be obtained using optional Class A1 RFI filters, which provide suppression of radio frequency interference and electromagnetic radiation in accordance with EN 55011.

On drives with enclosure size F, the Class A1 RFI filter requires the addition of the options cabinet.

Marine-use RFI filters are also available.

Insulation Resistance Monitor (IRM)

Monitors the insulation resistance in ungrounded systems (IT systems in IEC terminology) between the system phase conductors and ground. There is an ohmic pre-warning and a main alarm setpoint for the insulation level. Associated with each setpoint is an SPDT alarm relay for external use. Only one insulation resistance monitor can be connected to each ungrounded (IT) system.

- Integrated into the drive's Safe Torque Off circuit
- LCD display of insulation resistance
- Fault memory
- INFO, TEST and RESET key

Residual Current Device (RCD)

Uses the core balance method to monitor ground fault currents in grounded and high-resistance grounded systems (TN and TT systems in IEC terminology). There is a pre-warning (50% of main alarm setpoint) and a main alarm setpoint. Associated with each setpoint is an SPDT alarm relay for external use. Requires an external "window-type" current transformer (supplied and installed by customer).

- Integrated into the drive's Safe Torque Off circuit
- IEC 60755 Type B device monitors, pulsed DC, and pure DC ground fault currents
- LED bar graph indicator of the ground fault current level from 10-100% of the setpoint
- Fault memory
- TEST / RESET key

Safe Torque Off with Pilz Safety Relay

Available for drives with enclosure size F. Enables the Pilz Relay to fit in the enclosure without requiring an options cabinet.

Emergency Stop with Pilz Safety Relay

Includes a redundant 4-wire emergency stop pushbutton mounted on the front of the enclosure, and a Pilz relay that monitors it in conjunction with the drive's Safe Torque Off circuit and contactor position. Requires a contactor and the options cabinet for drives with enclosure size F.

Brake Chopper (IGBTs)

Brake terminals with an IGBT brake chopper circuit allow for the connection of external brake resistors. For detailed data on brake resistors please see the VLT® Brake Resistor MCE 101 Design Guide, MG.90.Ox.yy, available at <http://drivesliterature.danfoss.com/>

Regeneration terminals

Allow connection of regeneration units to the DC bus on the capacitor bank side of the DC-link reactors for regenerative braking. The enclosure size F regeneration terminals are sized for approximately 50% of the power rating of the drive. Consult the factory for regeneration power limits based on the specific drive size and voltage.

Load sharing terminals

These terminals connect to the DC-bus on the rectifier side of the DC-link reactor and allow for the sharing of DC bus power between multiple drives. For drives with enclosure size F, the load sharing terminals are sized for approximately 33% of the power rating of the drive. Consult the factory for load sharing limits based on the specific drive size and voltage.

Disconnect

A door-mounted handle disconnect switch to enable and disable power to the drive, increasing safety during servicing. The disconnect is interlocked with the cabinet doors to prevent them from being opened while power is still applied.

Circuit breakers

A circuit breaker can be remotely tripped, but must be manually reset. Circuit breakers are interlocked with the cabinet doors to prevent them from being opened while power is still applied. When a circuit breaker is ordered as an option, fuses are also included for fast-acting current overload protection of the AC drive.

Contactors

An electrically controlled contactor switch allows for the remote enabling and disabling of power to the drive. An auxiliary contact on the contactor is monitored by the Pilz Safety Module if the IEC Emergency Stop option is ordered.

Manual motor starters

Provide 3-phase power for electric cooling blowers that are often required for larger motors. Power for the starters is provided from the load side of any supplied contactor, circuit breaker or disconnect switch. If a Class 1 RFI filter option is ordered, the input side of the RFI provides the power to the starter. Power is fused before each motor starter and is off when the incoming power to the drive is off. Up to two starters are allowed. If a 30 A, fuse-protected circuit is ordered, then only one starter is allowed. Starters are integrated into the drive's Safe Torque Off circuit.

Unit features include:

- Operation switch (on/off)
- Short circuit and overload protection with test function
- Manual reset function

30 A, fuse-protected terminals

- 3-phase power matching incoming mains voltage for powering auxiliary customer equipment
- Not available if two manual motor starters are selected
- Terminals are off when the incoming power to the drive is off
- Power for the fused-protected terminals will be provided from the load side of any supplied contactor, circuit breaker, or disconnect switch. If a Class 1 RFI filter option is ordered, the input side of the RFI provides the power to the starter.

Common Motor Terminals

The common motor terminal option provides the bus bars and hardware required to connect the motor terminals from the paralleled inverters to a single terminal (per phase) to accommodate the installation of the motor-side top entry kit.

This option is also recommended to connect the output of a drive to an output filter or output contactor. The common motor terminals eliminate the need for equal cable lengths from each inverter to the common point of the output filter (or motor).

24 V DC supply

- 5 A, 120 W, 24 V DC
- Protected against output overcurrent, overload, short circuits, and overtemperature
- For powering customer-supplied accessory devices such as sensors, PLC I/O, contactors, temperature probes, indicator lights and/or other electronic hardware
- Diagnostics include a dry DC-ok contact, a green DC-ok LED and a red overload LED
- Version with RTC available

External temperature monitoring

Designed for monitoring temperatures of external system components, such as the motor windings and/or bearings. Includes eight universal input modules plus two dedicated thermistor input modules. All ten modules are integrated into the drive's Safe Torque Off circuit and can be monitored via a fieldbus

network, which requires the purchase of a separate module/bus coupler. A Safe Torque Off brake option must be ordered when selecting external temperature monitoring.

Universal inputs (5)

Signal types:

- RTD inputs (including Pt100), 3-wire or 4-wire
- Thermocouple
- Analog current or analog voltage

Additional features:

- One universal output, configurable for analog voltage or analog current
- Two output relays (N.O.)
- Dual-line LC display and LED diagnostics
- Sensor lead wire break, short circuit and incorrect polarity detection
- Interface set-up software
- If 3 PTC are required, an MCB 112 control card option must be added.

Additional external temperature monitors:

- This option is available in case you need more than the MCB 114 and MCB 112 provides.

VLT® Control Panel LCP 101 (Numeric)

- Status messages
- Quick menu for easy commissioning
- Parameter setting and adjusting
- Hand-operated start/stop function or selection of Automatic mode
- Reset function

Ordering number
130B1124

VLT® Control Panel LCP 102 (Graphical)

- Multi-language display
- Quick menu for easy commissioning
- Full parameter back-up and copy function
- Alarm logging
- Info key explains the function of the selected item on display
- Hand-operated start/stop or selection of Automatic mode
- Reset function
- Trend graphing

Ordering number
130B1107

VLT® Wireless Communication Panel LCP 103

- Full access to the drive
- Real-time error messages
- PUSH notifications for alarms/warnings
- Safe and secure WPA2 encryption
- Intuitive parameter functionalities
- Live graphs for monitoring and fine tuning
- Multi-language support
- Upload or download parameter file to the built-in memory or to your smartphone

Ordering number
134B0460

Loose kits for enclosure sizes D, E and F

Kit	Available for following enclosure sizes
NEMA 3R outdoor weather shield	D1h, D2h
USB in the door kit	D1h, D2h, D3h, D4h, D5h, D6h, D7h, D8h, E1h, E2h, E3h, E4h, F
Enclosure size F top entry kit motor cables	F
Enclosure size F top entry kit mains cables	F
Common motor terminal kits	F1/F3, F2/F4
Adapter plate	D1h, D2h, D3h, D4h
Back-channel duct kit	D1h, D2h, D3h, D4h, E3h, E4h
NEMA 3R Rittal and welded enclosures	D3h, D4h
Back-channel cooling kits for non-Rittal enclosures	D3h, D4h
Back-channel cooling kit (in-bottom/out-top)	D1h, D2h, D3h, D4h, E3h, E4h
Back-channel cooling kit (in-back/out-back)	D1h, D2h, D3h, D4h, E3h, E4h, F
Pedestal kit with in-back/out-back cooling	D1h, D2h
Pedestal kit	D1h, D2h, D5h, D6h, D7h, D8h
Top entry of fieldbus cables	D3, D4, D1h-D8h
LCP Remote Mounting Kit	Available for the full product range
Ground bar kit	E1h, E2h

NEMA 3R outdoor weather shield

Designed to be mounted over the VLT® drive to protect from direct sun, snow and falling debris. Drives used with this shield must be ordered from the factory as "NEMA 3R Ready". This is an enclosure option in the type code – E5S.

Ordering number

D1h 176F6302
D2h 176F6303

USB in the door kit

Available for all enclosure sizes, this USB extension cord kit allows access to the drive controls via laptop computer without opening the drive.

The kits can only be applied to drives manufactured after a certain date. Drives built prior to these dates do not have the provisions to accommodate the kits. Reference the following table to determine which drives the kits can be applied to.

Ordering number

Enclosure sizes D 130B1155
Enclosure sizes E 130B1156
Enclosure sizes F 176F1784

Enclosure size F top entry kit motor cables

To use this kit, the drive must be ordered with the common motor terminal option. The kit includes everything to install a top entry cabinet on the motor side (right side) of an F size enclosure.

Ordering number

F1/F3, 400 mm 176F1838
F1/F3, 600 mm 176F1839
F2/F4 400 mm 176F1840
F2/F4, 600 mm 176F1841
F8, F9, F10, F11, F12, F13 *Contact factory*

Enclosure size F top entry kit mains cables

The kits include everything required to install a top entry section onto the mains side (left side) of an F size enclosure.

Ordering number

F1/F2, 400 mm	176F1832
F1/F2, 600 mm	176F1833
F3/F4 with disconnect, 400 mm	176F1834
F3/F4 with disconnect, 600 mm	176F1835
F3/F4 without disconnect, 400 mm	176F1836
F3/F4 without disconnect, 600 mm	176F1837
F8, F9, F10, F11, F12, F13	Contact factory

Common motor terminal kits

The common motor terminal kits provide the busbars and hardware required to connect the motor terminals from the paralleled inverters to a single terminal (per phase) to accommodate the installation of the motor-side top entry kit. This kit is equivalent to the common motor terminal option of a drive. This kit is not required to install the motor-side top entry kit if the common motor terminal option was specified when the drive was ordered.

This kit is also recommended to connect the output of a drive to an output filter or output contactor. The common motor terminals eliminate the need for equal cable lengths from each inverter to the common point of the output filter (or motor).

Ordering number

F1/F2, 400 mm	176F1832
F1/F2, 600 mm	176F1833

Adapter plate

The adapter plate is used to replace an old enclosure size D drive with the new enclosure size D drive, using the same mounting.

Ordering number

D1h/D3h adapter plate to replace	
D1/D3 drive.....	176F3409
D2h/D4h adapter plate to replace	
D2/D4 drive.....	176F3410

Back-channel duct kit

Back-channel duct kits are offered for conversion of enclosure sizes D and E. They are offered in two configurations – in-bottom/out-top venting and top only venting. Available for enclosure sizes D3h and D4h.

Ordering number top and bottom

D3h kit 1800 mm without pedestal	176F3627
D4h kit 1800 mm without pedestal	176F3628
D3h Kit 2000 mm with pedestal.....	176F3629
D4h Kit 2000 mm with pedestal.....	176F3630

NEMA 3R Rittal and welded enclosures

The kits are designed to be used with the IP00/IP20/Chassis drives to achieve an ingress protection rating of NEMA 3R or NEMA 4. These enclosures are intended for outdoor use to provide a degree of protection against inclement weather.

Ordering number for NEMA 3R (welded enclosures)

D3h back-channel cooling kit (in back out back).....	176F3521
D4h back-channel cooling kit (in back out back).....	176F3526

Ordering number for NEMA 3R (Rittal enclosures)

D3h back-channel cooling kit (in back out back).....	176F3633
D4h Back-channel cooling kit (in back out back).....	176F3634

Back-channel cooling kits for non-Rittal enclosures

The kits are designed to be used with the IP20/Chassis drives in non-Rittal enclosures for in-back/out-back cooling. Kits do not include plates for mounting in the enclosures.

Ordering number

D3h	176F3519
D4h	176F3524

Ordering number for corrosion resistant

D3h	176F3520
D4h	176F3525

Back-channel cooling kit (in-bottom/out-back)

Kit for directing the back-channel air flow in the bottom of the drive and out the back.

Ordering number

D1h/D3h.....	176F3522
D2h/D4h	176F3527

Ordering number corrosion resistant

D1h/D3h.....	176F3523
D2h/D4h	176F3528

Back-channel cooling kit (in-back/out-back)

These kits are designed to be used for redirecting the back-channel air flow. Factory back-channel cooling directs air in the bottom of the drive and out the top. The kit allows the air to be directed in and out the back of the drive.

Ordering number for in-back/out-back cooling kit

D1h.....	176F3648
D2h	176F3649
D3h	176F3625
D4h	176F3626
D5h/D6h	176F3530
D7h/D8h	176F3531

Ordering number for corrosion resistant

D1h.....	176F3656
D2h	176F3657
D3h	176F3654
D4h	176F3655

Ordering number for VLT® Low Harmonic Drives

D1n.....	176F6482
D2n	176F6481
E9	176F3538
F18.....	176F3534

Ordering number for VLT® Advanced Active Filter AAF 006

D14.....	176F3535
----------	----------

Telescopic back-channel cooling kit

Back-channel cooling kits for IP20/Chassis drives allow the heat sink air of the drive to be directed out of the panel in which the drive is installed. The new telescopic provides more flexibility and easier installation to fit inside the panel.

The kits are supplied in almost pre-assembled condition, and include a gland plate that fits standard Rittal enclosures.

Ordering numbers for E-frames:

E3h (in bottom/out top)	
600 mm bottom plate	176F6606
E3h (in bottom/out top)	
800 mm bottom plate	176F6607
E4h (in bottom/out top)	
800 mm bottom plate	176F6608
E3h (in back/out back)	176F6610

E4h (in back/out back).....	176F6611
E3h (in bottom/out back)	
600 mm bottom plate	176F6612
E3h (in bottom/out back)	
800 mm bottom plate	176F6613
E4h (in bottom/out back)	
800 mm bottom plate	176F6614
E3h (in back/out top).....	176F6615
E4h (in back/out top).....	176F6616

Pedestal kit with in-back/out-back cooling

See additional documents 177R0508 and 177R0509.

Ordering number

D1h 400 mm kit	176F3532
D2h 400 mm kit.....	176F3533

Pedestal kit

The pedestal kit is a 400 mm high pedestal for enclosure sizes D1h and D2h, and 200 mm high for enclosure sizes D5h and D6h, that allows the drives to be floor mounted. The front of the pedestal has openings for input air to cool the power components.

Ordering number

D1h 400 mm kit.....	176F3631
D2h 400 mm kit.....	176F3632
D5h/D6h 200 mm kit.....	176F3452
D7h/D8h 200 mm kit.....	176F3539

Input-plate option kit

Input-plate option kits are available for enclosure sizes D and E. The kits can be ordered to add fuses, disconnect/fuses, RFI, RFI/fuses and RFI/disconnect/fuses. Please consult the factory for kit ordering numbers.

Top entry of fieldbus cables

The top entry kit provides the ability to install fieldbus cables through the top of the drive. The kit is IP20 when installed. If an increased rating is desired, a different mating connector can be used.

Ordering number

D1h-D8h.....	176F3594
--------------	----------

LCP Remote Mounting Kit

The LCP Remote Mounting Kit offers an easy-to-install, IP54 design which you can mount on panels and walls of 1-90 mm thickness. The front cover blocks the sunlight for convenient programming. The closed cover is lockable to prevent tampering, while keeping the On/Warning/Alarm LEDs visible. It is compatible with all VLT® Local Control Panel options.

Ordering number for IP20 enclosure

3 m cable length	134B5223
5 m cable length	134B5224
10 m cable length.....	134B5225

Ground bar kit

More grounding points for E1h and E2h drives. The kit includes a pair of ground bars for installation inside the enclosure.

Ordering number

E1h/E2h.....	176F6609
--------------	----------



Stronger on the outside, more intelligent on the inside

Providing consistently awesome performance for almost 50 years, VLT® AutomationDrive is built to last. This robust drive operates effectively and reliably even with the most demanding applications and in the most challenging environments.

The modular VLT® AutomationDrive helps save energy, increase flexibility, reduce costs related to spare parts and servicing, and optimize process control on any industrial machine or production line across a wide range of industries.

Powder mixing
productivity triples
with wireless PROFINET
Huijbregts Groep, Holland



Read the story

Peroni Brewery selects
VLT® FlexConcept®
to **optimize**
operating costs
Peroni Brewery, Rome, Italy



Read the story

Italcementi enjoys
optimized process
performance in all
conditions
Italcementi Group (GSM Aggregates
limestone quarry, Roussas, France)



Read the story

Discover more case stories for the AutomationDrive industry here:
<https://goo.gl/RT4366>

Follow us and learn more about AC drives



VLT® | VAGON®

Danfoss can accept no responsibility for possible errors in catalogues, brochures and other printed material. Danfoss reserves the right to alter its products without notice. This also applies to products already on order provided that such alterations can be made without subsequential changes being necessary in specifications already agreed. All trademarks in this material are property of the respective companies. Danfoss and the Danfoss logotype are trademarks of Danfoss A/S. All rights reserved.